

# OSRAM PLPVYL1 940A\_E

## Datasheet

Published by **ams-OSRAM AG**

Tobelbader Strasse 30, 8141 Premstaetten, Austria

Phone +43 3136 500-0

[ams-osram.com](http://ams-osram.com)

© All rights reserved



BIDOS® E1005 L

# PLPVYL1 940A\_E

VCSEL (940 nm)

$P_{\text{opt,typ}} = 11 \text{ mW}$

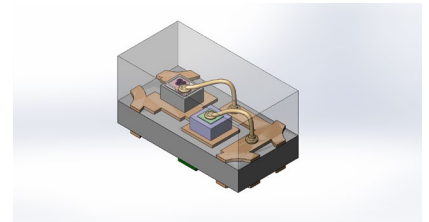

## Applications

- Appliances & Tools
- Body Tracking
- Display Management
- Factory Automation
- Home & Building Automation

## Features

- Package: clear epoxy
- ESD: 2 kV acc. to ANSI/ESDA/JEDEC JS-001 (HBM, Class 2)
- Multimode VCSEL
- Very small SMT package

## Ordering Information

$I_F = 15 \text{ mA}$ ;  $t_p = 1 \text{ ms}$

Type	Optical output power $P_{opt}$	Optical output power typ. $P_{opt}$	Ordering Code
PLPVYL1 940A_E	$\geq 7.7 \text{ mW}$	11 mW	Q65112A9493

Depending on the mode of operation, these devices emit highly concentrated visible and non-visible light which can be hazardous to the human eye. Products which incorporate these devices must follow the safety precautions given in the "Notes" section.

## Maximum Ratings

$T_A = 25\text{ °C}$

Parameter	Symbol		Values
Operating temperature	$T_{op}$	min.	-40 °C
		max.	85 °C
Storage temperature	$T_{stg}$	min.	-40 °C
		max.	85 °C
Junction temperature	$T_j$	max.	100 °C
Forward current	$I_F$	max.	20 mA
Surge current $t_p \leq 1\text{ ms}; D = 0$	$I_{FSM}$	max.	25 mA
Reverse voltage <sup>1)</sup>	$V_R$	max.	10 V
ESD withstand voltage acc. to ANSI/ESDA/JEDEC JS-001 (HBM, Class 2)	$V_{ESD}$	max.	2 kV

## Characteristics

$I_F = 15 \text{ mA}$ ;  $t_p = 1 \text{ ms}$ ;  $T_A = 25 \text{ °C}$

Parameter	Symbol	Values
Peak wavelength <sup>2)</sup>	$\lambda_{\text{peak}}$	min. 931 nm typ. 940 nm max. 949 nm
Spectral bandwidth at 50% $I_{e,rel,max}$	$\Delta\lambda$	typ. 4 nm
Optical output power <sup>3)</sup>	$P_{\text{opt}}$	min. 7.7 mW typ. 11 mW
Optical output power <sup>3)</sup> $I_F = 8 \text{ mA}$ ; $t_p = 1 \text{ ms}$	$P_{\text{opt}}$	min. 3.8 mW max. 6.8 mW
Beam divergence (1/e <sup>2</sup> ) - 0°	$\Theta$	typ. 18 ° max. 25 °
Beam divergence (1/e <sup>2</sup> ) - 90°	$\Theta$	typ. 18 ° max. 25 °
Threshold current	$I_{\text{th}}$	typ. 2 mA
Forward voltage <sup>4)</sup>	$V_F$	min. 1.8 V typ. 2.0 V max. 2.2 V
Forward voltage <sup>4)</sup> $I_F = 10 \text{ }\mu\text{A}$ ; $t_p = 10 \text{ ms}$	$V_F$	min. 0.7 V
Thermal resistance junction solder point real	$R_{\text{thJS real}}$	max. 270 K / W

## Forward Voltage Groups

$I_F = 15 \text{ mA}$ ;  $t_p = 1 \text{ ms}$

Group	Forward voltage <sup>4)</sup> min. $V_F$	Forward voltage <sup>4)</sup> max. $V_F$
1	1.8 V	1.9 V
2	1.9 V	2.0 V
3	2.0 V	2.1 V
4	2.1 V	2.2 V

### Relative Spectral Emission <sup>5), 6)</sup>

$$I_{e,rel} = f(\lambda); I_F = 15 \text{ mA}; t_p = 1 \text{ ms}$$

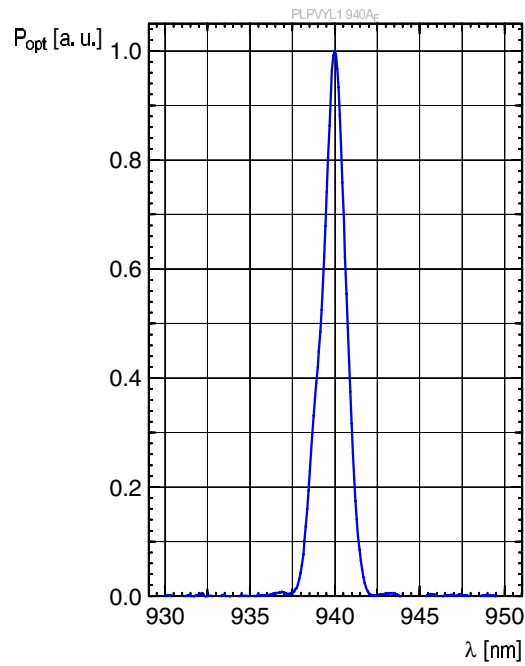

### Radiation Characteristics <sup>5), 6)</sup>

$$I_{e,rel} = f(\varphi)$$

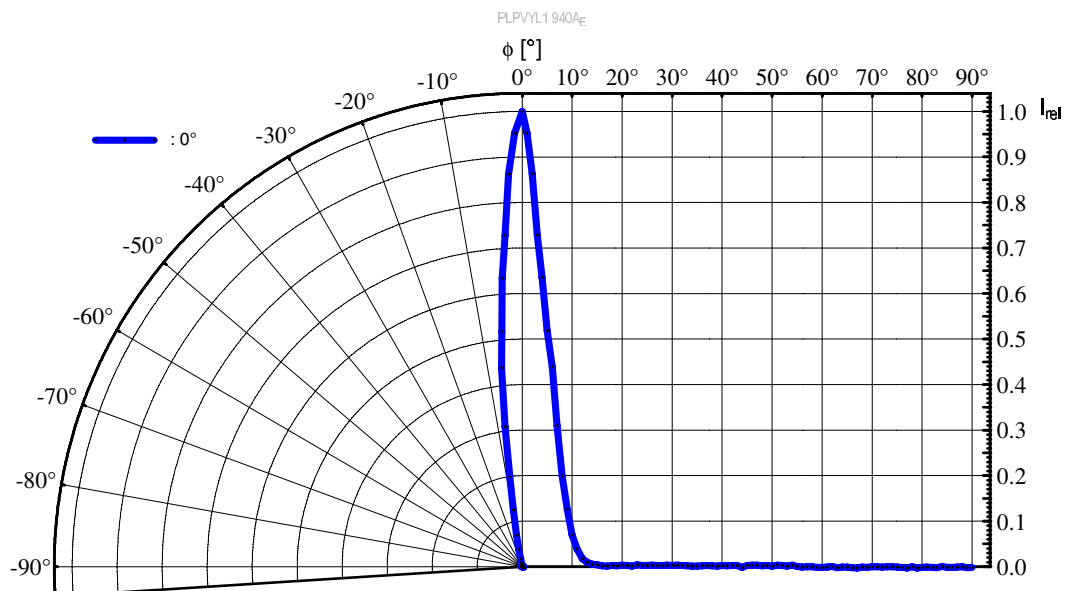

### Optical Output Power 5), 6)

$$P_{opt} = f(I_F)$$

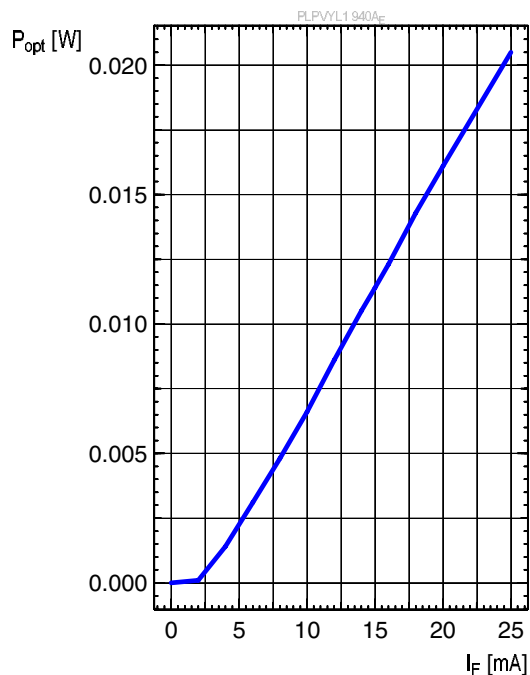

### Forward Voltage 5), 6)

$$V_F = f(I_F)$$

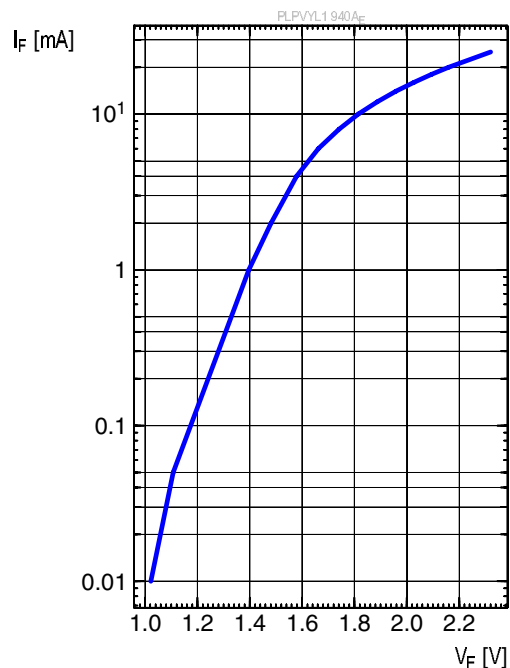

### Max. Permissible Forward Current

$$I_F = f(T_S); R_{th_{js}} = 270 \text{ K / W}$$

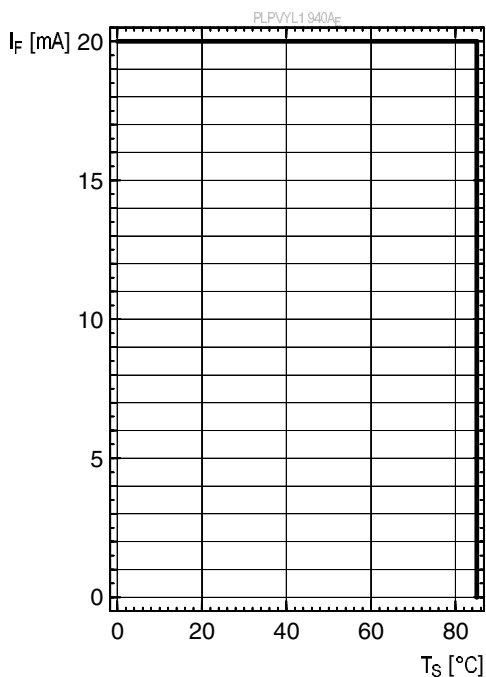

### Permissible Pulse Handling Capability

$$I_F = f(t_p); \text{ duty cycle } D = \text{parameter}; T_A = 85^\circ\text{C}$$

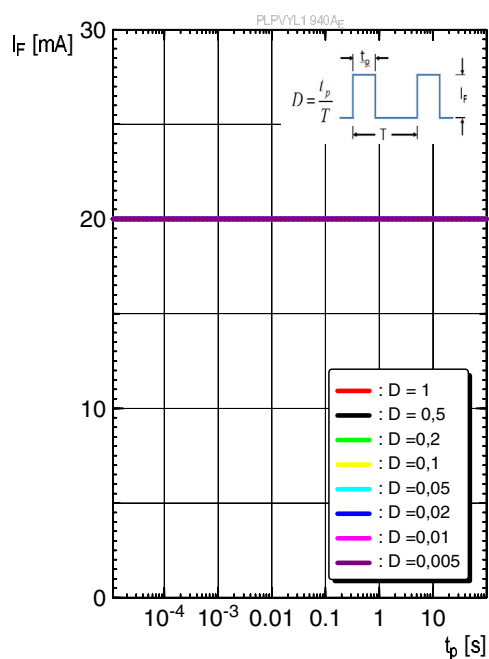



## Dimensional Drawing <sup>7)</sup>

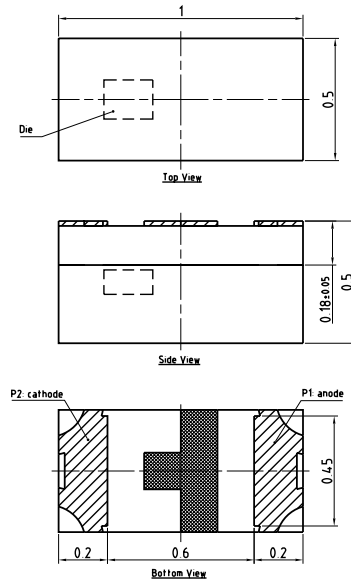

general tolerance : 0.1  
lead finish Au 

C67062-A0336-A1-02

## Further Information:

Approximate Weight: 0.6 mg

Recommended Solder Pad <sup>7)</sup>

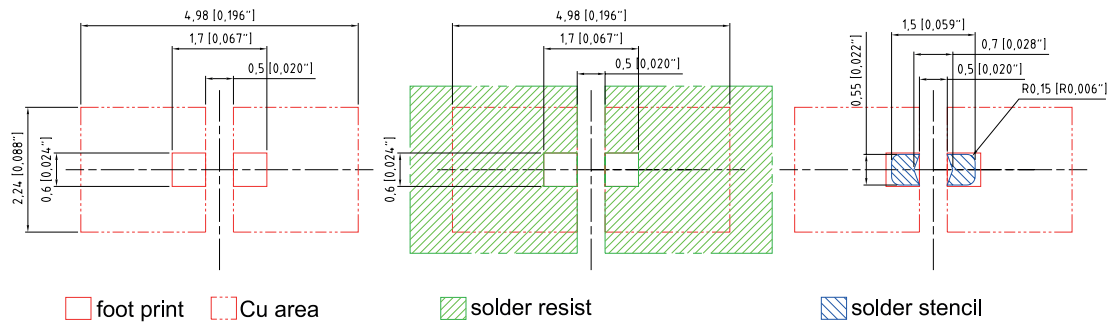

Component Location on Pad

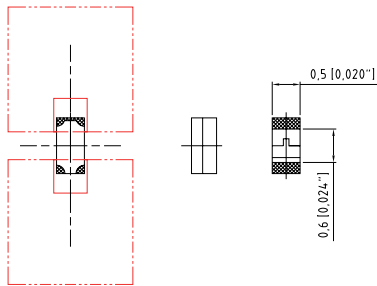

E062.3010.122 -01

## Reflow Soldering Profile

Product complies to MSL Level 3 acc. to JEDEC J-STD-020E

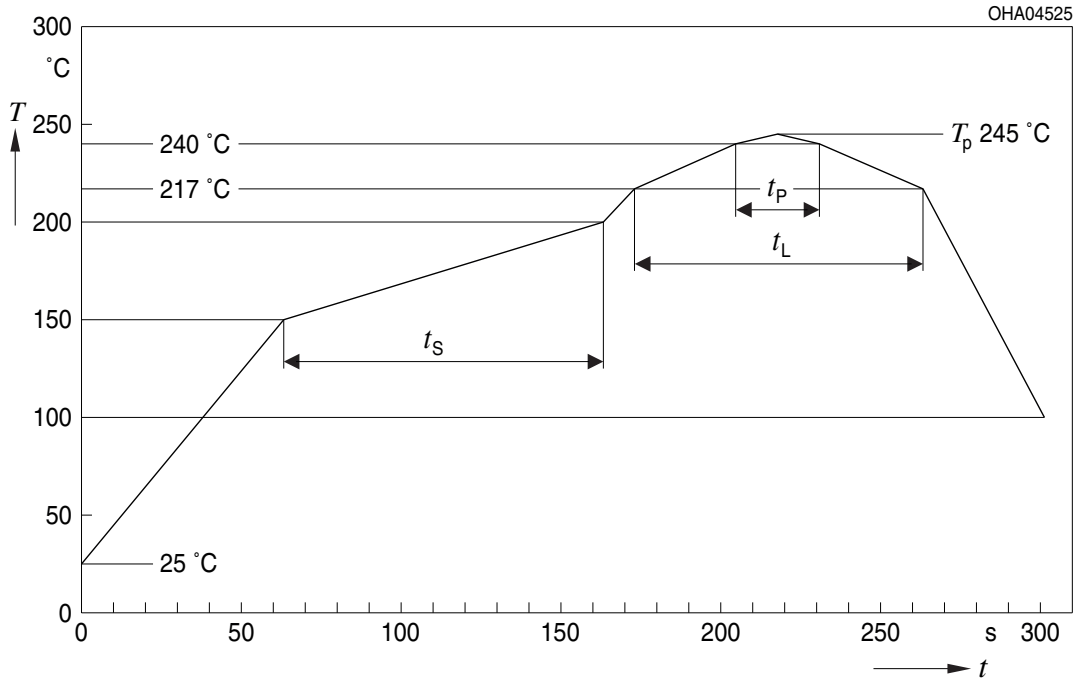

Profile Feature	Symbol	Pb-Free (SnAgCu) Assembly			Unit
		Minimum	Recommendation	Maximum	
Ramp-up rate to preheat <sup>*)</sup> 25 °C to 150 °C			2	3	K/s
Time $t_s$ $T_{Smin}$ to $T_{Smax}$	$t_s$	60	100	120	s
Ramp-up rate to peak <sup>*)</sup> $T_{Smax}$ to $T_p$			2	3	K/s
Liquidus temperature	$T_L$		217		°C
Time above liquidus temperature	$t_L$		80	100	s
Peak temperature	$T_p$		245	260	°C
Time within 5 °C of the specified peak temperature $T_p - 5$ K	$t_p$	10	20	30	s
Ramp-down rate* $T_p$ to 100 °C			3	6	K/s
Time 25 °C to $T_p$				480	s

All temperatures refer to the center of the package, measured on the top of the component  
<sup>\*)</sup> slope calculation  $DT/Dt$ :  $Dt$  max. 5 s; fulfillment for the whole T-range

Taping <sup>7)</sup>

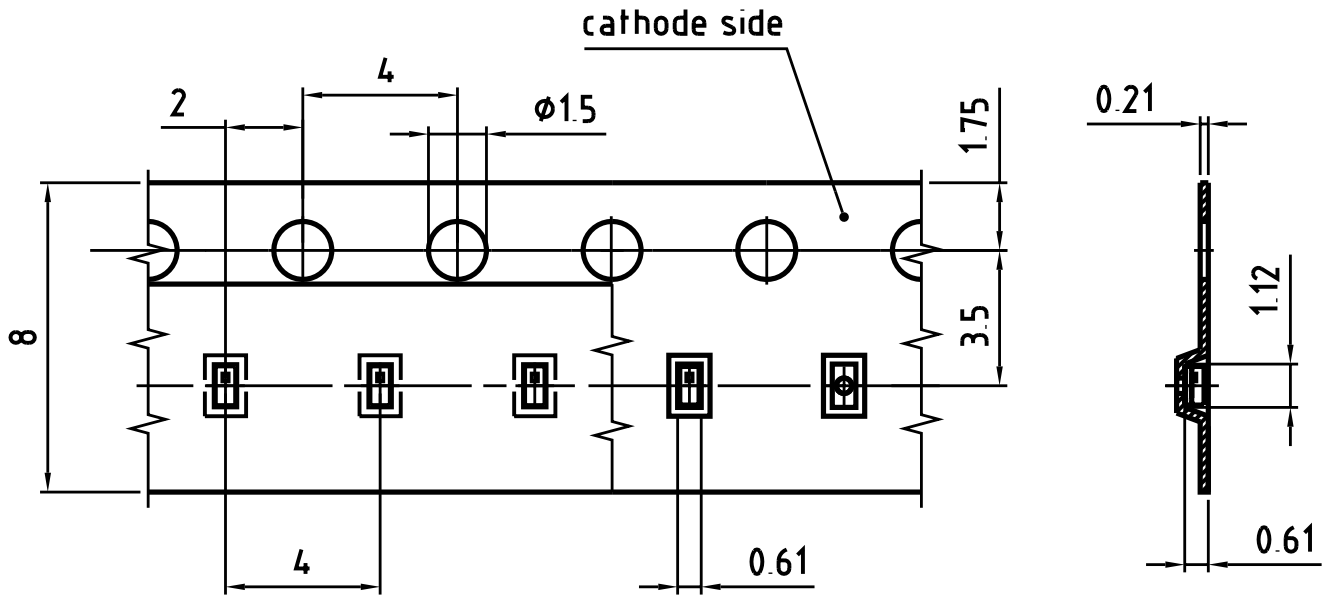

C67062-A0339-B1-01

**Tape and Reel** <sup>8)</sup>

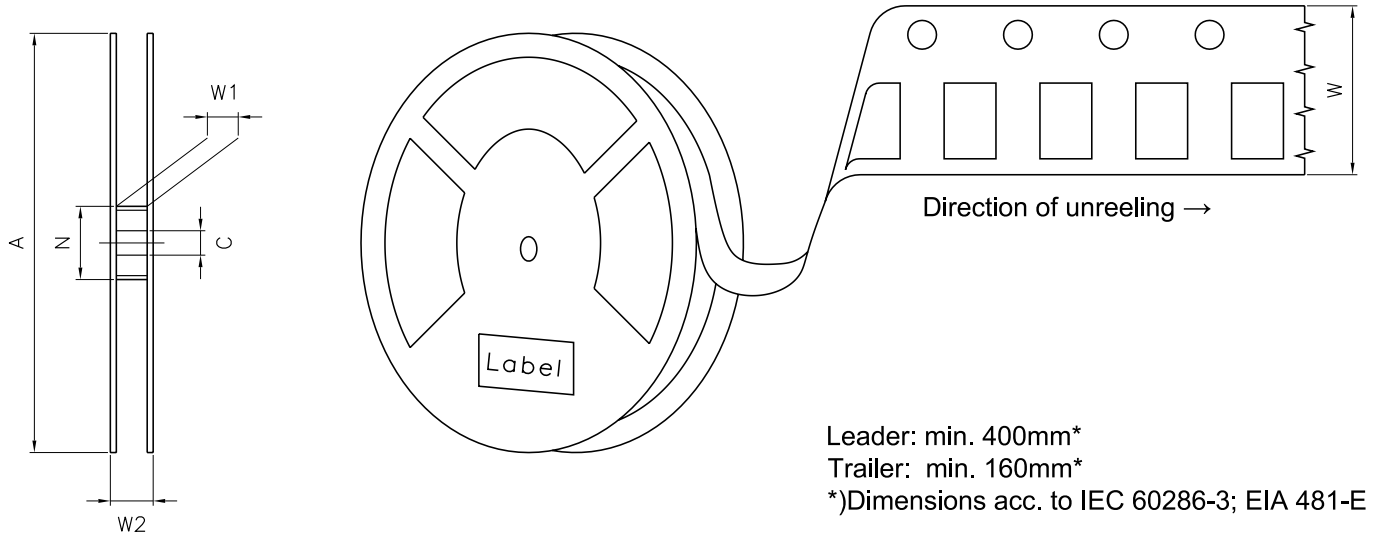

**Reel Dimensions**

A	W	N <sub>min</sub>	W <sub>1</sub>	W <sub>2 max</sub>	Pieces per PU
180 mm	8 + 0.3 / - 0.1 mm	60 mm	8.4 + 2 mm	14.4 mm	3000

## Barcode-Product-Label (BPL)

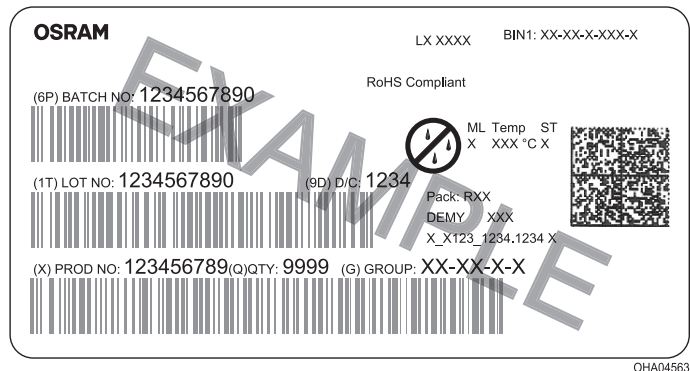

OHA04563

## Dry Packing Process and Materials <sup>7)</sup>

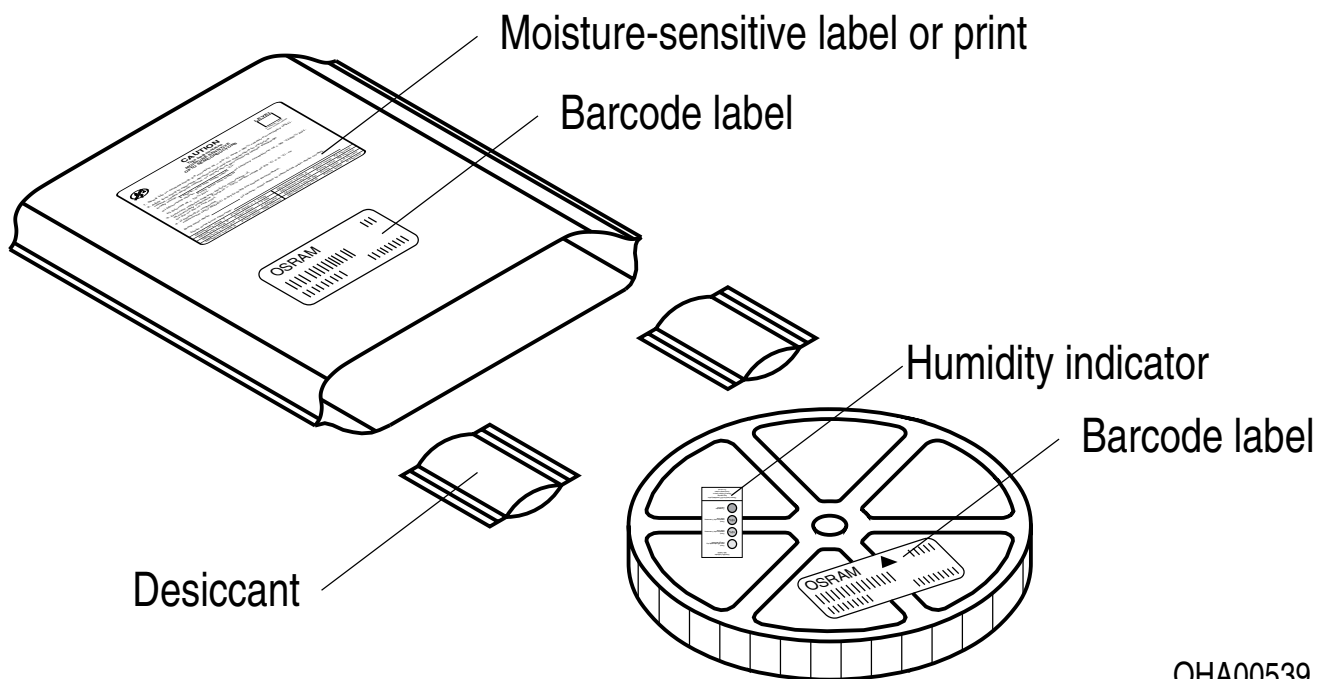

OHA00539

Moisture-sensitive product is packed in a dry bag containing desiccant and a humidity card according JEDEC-STD-033.

## Notes

The evaluation of eye safety occurs according to the standard IEC 62471:2006 (photo biological safety of lamps and lamp systems). Within the risk grouping system of this IEC standard, the device specified in this data sheet falls into **exempt risk group - Exempt**.

Subcomponents of this device contain, in addition to other substances, metal filled materials including silver. Metal filled materials can be affected by environments that contain traces of aggressive substances. Therefore, we recommend that customers minimize device exposure to aggressive substances during storage, production, and use. Devices that showed visible discoloration when tested using the described tests above did show no performance deviations within failure limits during the stated test duration. Respective failure limits are described in the IEC60810.

For further application related information please visit <https://ams-osram.com/support/application-notes>

---

## Disclaimer

### Attention please!

The information describes the type of component and shall not be considered as assured characteristics. Terms of delivery and rights to change design reserved. Due to technical requirements components may contain dangerous substances.

For information on the types in question please contact our Sales Organization.

If printed or downloaded, please find the latest version on our website.

### Packing

Please use the recycling operators known to you. We can also help you – get in touch with your nearest sales office. By agreement we will take packing material back, if it is sorted. You must bear the costs of transport. For packing material that is returned to us unsorted or which we are not obliged to accept, we shall have to invoice you for any costs incurred.

### Product and functional safety devices/applications or medical devices/applications

Our components are not developed, constructed or tested for the application as safety relevant component or for the application in medical devices.

Our products are not qualified at module and system level for such application.

In case buyer – or customer supplied by buyer – considers using our components in product safety devices/ applications or medical devices/applications, buyer and/or customer has to inform our local sales partner immediately and we and buyer and /or customer will analyze and coordinate the customer-specific request between us and buyer and/or customer.



---

## Glossary

- 1) **Reverse Operation:** This product is intended to be operated applying a forward current within the specified range. Applying any continuous reverse bias or forward bias below the voltage range of light emission shall be avoided because it may cause migration which can change the electro-optical characteristics or damage the LED.
- 2) **Wavelength:**  $\lambda_{\text{peak}}$  is measured with an internal reproducibility of  $\pm 0.7$  nm (acc. to GUM with a coverage factor of  $k = 3$ ).
- 3) **Brightness:** The brightness values are measured with a tolerance of  $\pm 11\%$ .
- 4) **Forward Voltage:** The forward voltages are measured with a tolerance of  $\pm 0.1$  V.
- 5) **Typical Values:** Due to the special conditions of the manufacturing processes of semiconductor devices, the typical data or calculated correlations of technical parameters can only reflect statistical figures. These do not necessarily correspond to the actual parameters of each single product, which could differ from the typical data and calculated correlations or the typical characteristic line. If requested, e.g. because of technical improvements, these typ. data will be changed without any further notice.
- 6) **Testing temperature:**  $T_A = 25^\circ\text{C}$  (unless otherwise specified)
- 7) **Tolerance of Measure:** Unless otherwise noted in drawing, tolerances are specified with  $\pm 0.1$  and dimensions are specified in mm.
- 8) **Tape and Reel:** All dimensions and tolerances are specified acc. IEC 60286-3 and specified in mm.

---

## Revision History

Version	Date	Change
1.0	2020-10-30	Initial Version
1.1	2021-11-10	Ordering Information Characteristics Further Information
1.2	2022-02-08	Derating (Diagrams)
1.3	2023-05-11	New Layout Applications
1.4	2023-07-20	Characteristics Forward Voltage Groups

---



EU RoHS and China RoHS compliant product

此产品符合欧盟 RoHS 指令的要求；  
按照中国的相关法规和标准，  
不含有毒有害物质或元素。

**Published by ams-OSRAM AG**

Tobelbader Strasse 30, 8141 Premstaetten, Austria

Phone +43 3136 500-0

[ams-osram.com](http://ams-osram.com)

© All rights reserved

**am** 

**OSRAM**

## **X-ON Electronics**

Largest Supplier of Electrical and Electronic Components

*Click to view similar products for [VCSEL Lasers](#) category:*

*Click to view products by [Osram](#) manufacturer:*

Other Similar products are found below :

[ATBX-00-MQ](#) [ASBX-00-MQ](#) [ASDX-00-MQ](#) [ATDX-00-MQ](#) [ATCX-00-MQ](#) [PLPVYL1 940A\\_E](#) [V105Q121A-940](#) [V205Q131A-940](#)  
[V105Q131A-940](#) [V205Q121A-940](#) [OPV300](#) [OPV302](#) [OPV310](#) [OPV310Y](#) [OPV314](#) [OPV314AT](#) [OPV314Y](#) [OPV314YAT](#) [OPV314YBT](#)  
[OPV315AT](#) [OPV322](#) [OPV330](#) [OPV332](#) [OPV382](#) [159353850B1300](#) [159353850A6300](#) [159353940B1300](#) [159353940A6300](#)