

OSRAM SFH 7050A

Datasheet

Published by **ams-OSRAM AG**

Tobelbader Strasse 30, 8141 Premstaetten, Austria

Phone +43 3136 500-0

ams-osram.com

© All rights reserved



BIOFY®

SFH 7050A

Biomonitoring Sensor



Applications

- Health Monitoring (Heart Rate Monitoring, Pulse Oximetry)

Features

- ESD: 2 kV acc. to ANSI/ESDA/JEDEC JS-001 (HBM, Class 2)
- Multi chip package featuring 3 emitters and one detector
- Small package: (WxDxH) 4.7mm x 2.5 mm x 0.9 mm
- Light Barrier to block optical crosstalk

Ordering Information

Type	Ordering Code
SFH 7050A	Q65113A3203
● green	
● red	
● infrared (940 nm)	
■ photodiode	

Pin configuration

Pin	Name	Function
1	Green	Green LED Cathode
2	Green	Green LED Anode
3	Red	Red LED Anode
4	PD	Photodiode Anode
5	PD	Photodiode Cathode
6	Red	Red LED Cathode
7	IR	IR LED Anode
8	IR	IR LED Cathode

Top View

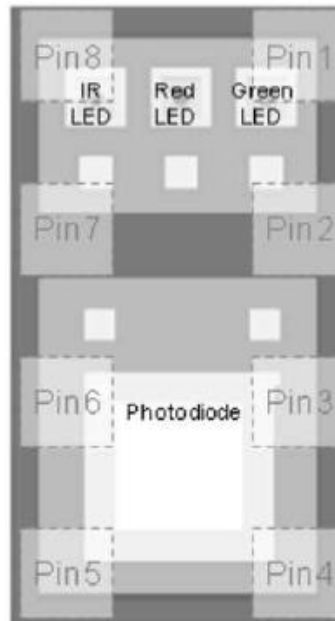

Block diagram

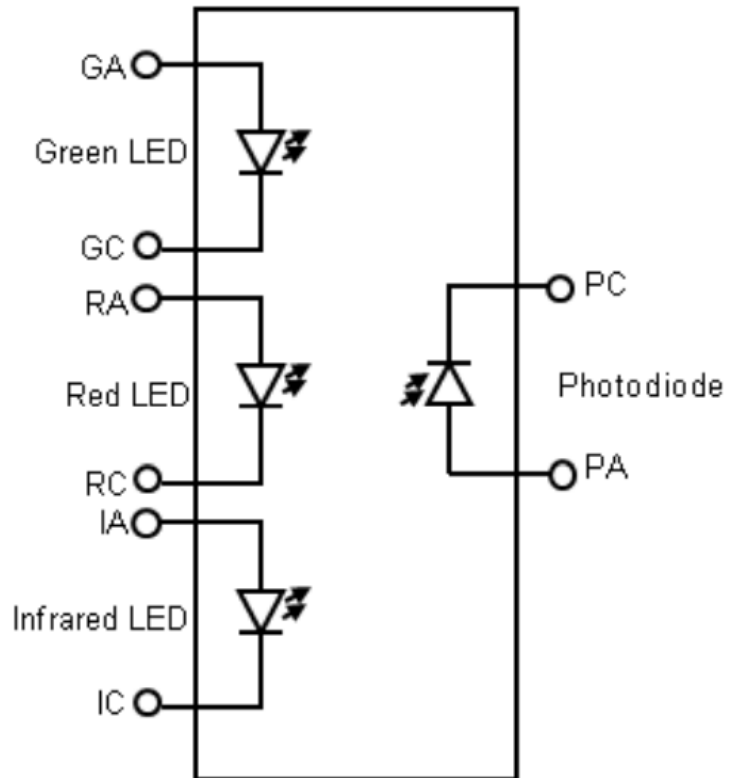

Maximum Ratings

$T_A = 25\text{ °C}$

Parameter	Symbol		Values
Operating temperature range	T_{op}	min.	-40 °C
		max.	85 °C
Storage temperature range	T_{stg}	min.	-40 °C
		max.	85 °C
ESD withstand voltage acc. to ANSI/ESDA/JEDEC JS-001 - HBM	V_{ESD}	max.	2 kV
Green Emitter			
Reverse voltage	V_R		not designed for reverse operation
Forward current	$I_F(DC)$	max.	25 mA
Forward current pulsed $t_p \leq 60\ \mu s$; $D = 0.005$	$I_F\ pulse$	max.	300 mA
Red Emitter			
Reverse voltage ⁵⁾	V_R	max.	12 V
Forward current	$I_F(DC)$	max.	70 mA
Forward current pulsed $t_p \leq 6\ ms$; $D = 0.005$	$I_F\ pulse$	max.	300 mA
Infrared Emitter			
Reverse voltage ⁵⁾	V_R	max.	5 V
Forward current	$I_F(DC)$	max.	60 mA
Forward current pulsed $t_p \leq 60\ \mu s$; $D = 0.005$	$I_F\ pulse$	max.	1 A
Photodiode			
Reverse voltage	V_R	max.	6 V

Characteristics

$T_A = 25\text{ °C}$

Parameter	Symbol		Values
Green Emitter			
Peak wavelength $I_F = 20\text{ mA}; t_p = 20\text{ ms}$	λ_{peak}	typ.	525 nm
Centroid Wavelength ⁶⁾ $I_F = 20\text{ mA}; t_p = 20\text{ ms}$	$\lambda_{\text{centroid}}$	min.	520 nm
		typ.	530 nm
		max.	540 nm
Spectral bandwidth at 50% $I_{\text{rel,max}}$ (FWHM) $I_F = 20\text{ mA}; t_p = 20\text{ ms}$	$\Delta\lambda$	typ.	34 nm
Half angle	ϕ	typ.	$\pm 60\text{ °}$
Rise time (10%/ 90%) $I_F = 100\text{ mA}; R_L = 50\ \Omega$	t_r	typ.	32 ns
Fall time (10%/ 90%) $I_F = 100\text{ mA}; R_L = 50\ \Omega$	t_f	typ.	80 ns
Forward voltage ⁸⁾ $I_F = 20\text{ mA}; t_p = 20\text{ ms}$	V_F	typ.	2.6 V
		max.	3.1 V
Reverse current $V_R = 5\text{ V}$	I_R		not designed for reverse operation
Radiant intensity $I_F = 20\text{ mA}; t_p = 20\text{ ms}$	I_e	typ.	1.9 mW / sr
Total radiant flux $I_F = 20\text{ mA}; t_p = 20\text{ ms}$	Φ_e	typ.	4.5 mW
Temperature coefficient of wavelength $I_F = 20\text{ mA}; t_p = 20\text{ ms}$	TC_λ	typ.	0.03 nm / K
Temperature coefficient of voltage $I_F = 20\text{ mA}; t_p = 20\text{ ms}$	TC_V	typ.	-3.6 mV / K
Thermal resistance junction ambient real	R_{thja}	max.	160 K/W

Characteristics

$T_A = 25\text{ °C}$

Parameter	Symbol		Values
Red Emitter			
Peak wavelength $I_F = 20\text{ mA}; t_p = 20\text{ ms}$	λ_{peak}	typ.	660 nm
Centroid Wavelength ⁶⁾ $I_F = 20\text{ mA}; t_p = 20\text{ ms}$	$\lambda_{\text{centroid}}$	min.	652 nm
		typ.	655 nm
		max.	658 nm
Spectral bandwidth at 50% $I_{\text{rel,max}}$ (FWHM) $I_F = 20\text{ mA}; t_p = 20\text{ ms}$	$\Delta\lambda$	typ.	17 nm
Half angle	ϕ	typ.	$\pm 60\text{ °}$
Rise time (10%/ 90%) $I_F = 100\text{ mA}; R_L = 50\ \Omega$	t_r	typ.	24 ns
Fall time (10%/ 90%) $I_F = 100\text{ mA}; R_L = 50\ \Omega$	t_f	typ.	24 ns
Forward voltage ⁸⁾ $I_F = 20\text{ mA}; t_p = 20\text{ ms}$	V_F	min.	1.7 V
		typ.	1.9 V
		max.	2.2 V
Reverse current $V_R = 12\text{ V}$	I_R		not designed for reverse operation
Radiant intensity $I_F = 20\text{ mA}; t_p = 20\text{ ms}$	I_e	typ.	2.9 mW / sr
Total radiant flux $I_F = 20\text{ mA}; t_p = 20\text{ ms}$	Φ_e	typ.	7.3 mW
Temperature coefficient of wavelength $I_F = 20\text{ mA}; t_p = 20\text{ ms}$	TC_{λ}	typ.	0.13 nm / K
Thermal resistance junction ambient real	R_{thja}	max.	320 K/W

Characteristics

$T_A = 25\text{ °C}$

Parameter	Symbol		Values
Infrared Emitter			
Peak wavelength $I_F = 20\text{ mA}; t_p = 20\text{ ms}$	λ_{peak}	typ.	950 nm
Centroid Wavelength ⁶⁾ $I_F = 20\text{ mA}; t_p = 20\text{ ms}$	$\lambda_{\text{centroid}}$	min.	930 nm
		typ.	940 nm
		max.	950 nm
Spectral bandwidth at 50% $I_{\text{rel,max}}$ (FWHM) $I_F = 20\text{ mA}; t_p = 20\text{ ms}$	$\Delta\lambda$	typ.	42 nm
Half angle	Φ	typ.	$\pm 60\text{ °}$
Rise time (10%/ 90%) $I_F = 100\text{ mA}; R_L = 50\ \Omega$	t_r	typ.	16 ns
Fall time (10%/ 90%) $I_F = 100\text{ mA}; R_L = 50\ \Omega$	t_f	typ.	16 ns
Forward voltage ⁸⁾ $I_F = 20\text{ mA}; t_p = 20\text{ ms}$	V_F	typ.	1.3 V
		max.	1.8 V
Reverse current $V_R = 5\text{ V}$	I_R		Not designed for reverse operation
Radiant intensity $I_F = 20\text{ mA}; t_p = 20\text{ ms}$	I_e	typ.	2 mW / sr
Total radiant flux $I_F = 20\text{ mA}; t_p = 20\text{ ms}$	Φ_e	typ.	5.3 mW
Temperature coefficient of brightness $I_F = 20\text{ mA}; t_p = 20\text{ ms}$	TC_I	typ.	-0.3 % / K
Temperature coefficient of wavelength $I_F = 20\text{ mA}; t_p = 20\text{ ms}$	TC_λ	typ.	0.25 nm / K
Temperature coefficient of voltage $I_F = 20\text{ mA}; t_p = 20\text{ ms}$	TC_V	typ.	-0.8 mV / K
Thermal resistance junction ambient real	$R_{th_{ja}}$	max.	230 K/W

Characteristics

$T_A = 25\text{ °C}$

Parameter	Symbol		Values
Broadband Photodiode			
Wavelength of max. sensitivity	$\lambda_{S\text{ max}}$	typ.	900 nm
Spectral range of sensitivity	$\lambda_{10\%}$	typ.	400 ... 1100 nm
Photocurrent $E_e = 0.1\text{ mW/cm}^2$; $\lambda = 530\text{ nm}$; $V_R = 5\text{ V}$	I_P	typ.	0.5 μA
Photocurrent $E_e = 0.1\text{ mW/cm}^2$; $\lambda = 655\text{ nm}$; $V_R = 5\text{ V}$	I_P	typ.	0.75 μA
Photocurrent $E_e = 0.1\text{ mW/cm}^2$; $\lambda = 940\text{ nm}$; $V_R = 5\text{ V}$	I_P	typ.	1.22 μA
Radiant sensitive area	A	typ.	1.51 mm ²
Dimensions of active chip area	L x W	typ.	1.23 x 1.23 mm x mm
Dark current $V_R = 5\text{ V}$; $E = 0$	I_R	typ. max.	0.1 nA 25 nA
Spectral sensitivity of the chip $\lambda = 535\text{ nm}$	S_λ	typ.	0.34 A / W
Open-circuit voltage $E_e = 0.1\text{ mW/cm}^2$; $\lambda = 530\text{ nm}$	V_o	typ.	510 mV
Rise time (10%/ 90%) $V_R = 5\text{ V}$; $R_L = 50\ \Omega$; $\lambda = 535\text{ nm}$	t_r	typ.	47 ns
Fall time (10%/ 90%) $V_R = 5\text{ V}$; $R_L = 50\ \Omega$; $\lambda = 535\text{ nm}$	t_f	typ.	67 ns
Forward voltage $I_F = 10\text{ mA}$; $E = 0$	V_F	typ..	0.95 V
Capacitance $V_R = 0\text{ V}$; $f = 1\text{ MHz}$; $E = 0$	C_0	typ.	13.4 pF

Relative Spectral Emission 1), 2)

- green: $I_{e,rel} = f(\lambda)$; $I_F = 20 \text{ mA}$; $t_p = 20 \text{ ms}$

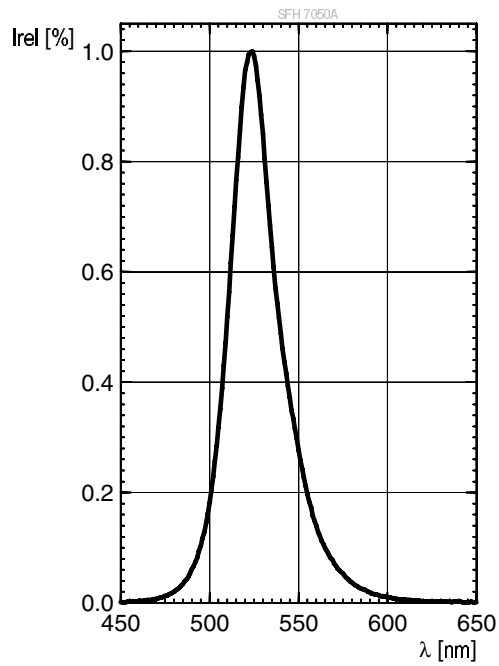

Relative Spectral Emission 1), 2)

- red: $I_{e,rel} = f(\lambda)$; $I_F = 20 \text{ mA}$; $t_p = 20 \text{ ms}$

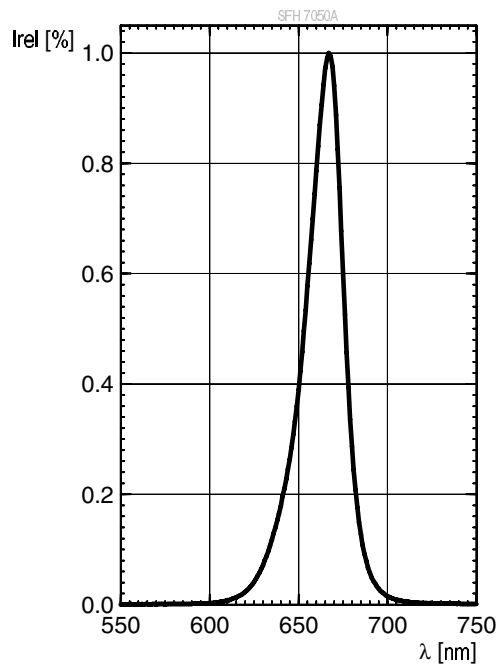

Relative Spectral Emission ^{1), 2)}

- infrared (940 nm): $I_{e,rel} = f(\lambda)$; $I_F = 20 \text{ mA}$; $t_p = 20 \text{ ms}$

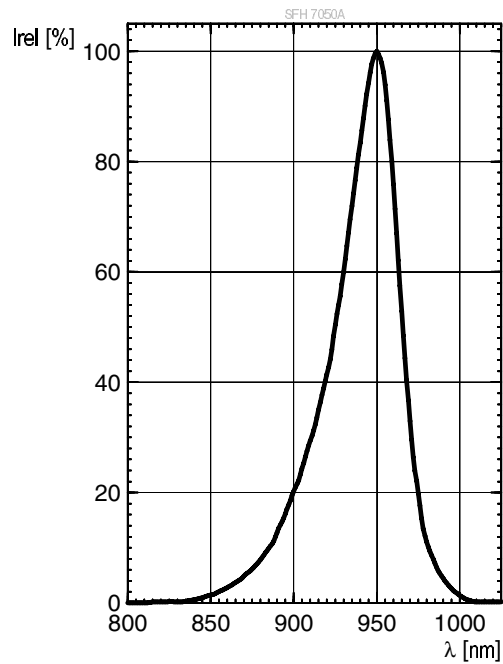

Radiation Characteristics ^{1), 2)}

true green/ hyper red/ infrared: $I_{e,rel} = f(\varphi)$

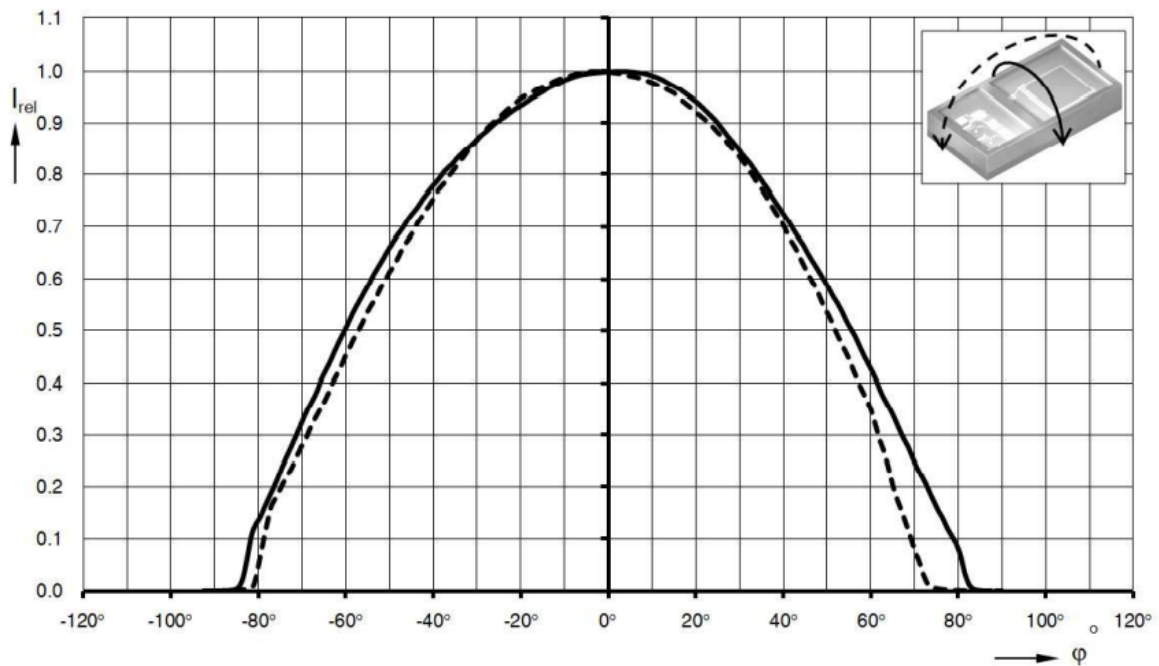

Relative Spectral Sensitivity ^{1), 2)}

■ photodiode: $S_{rel} = f(\lambda)$

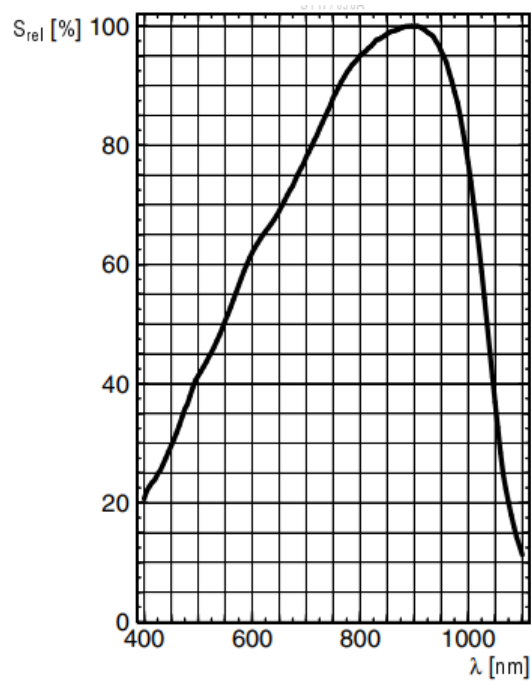

Directional Characteristics ^{1), 2)}

■ photodiode: $S_{rel} = f(\varphi)$

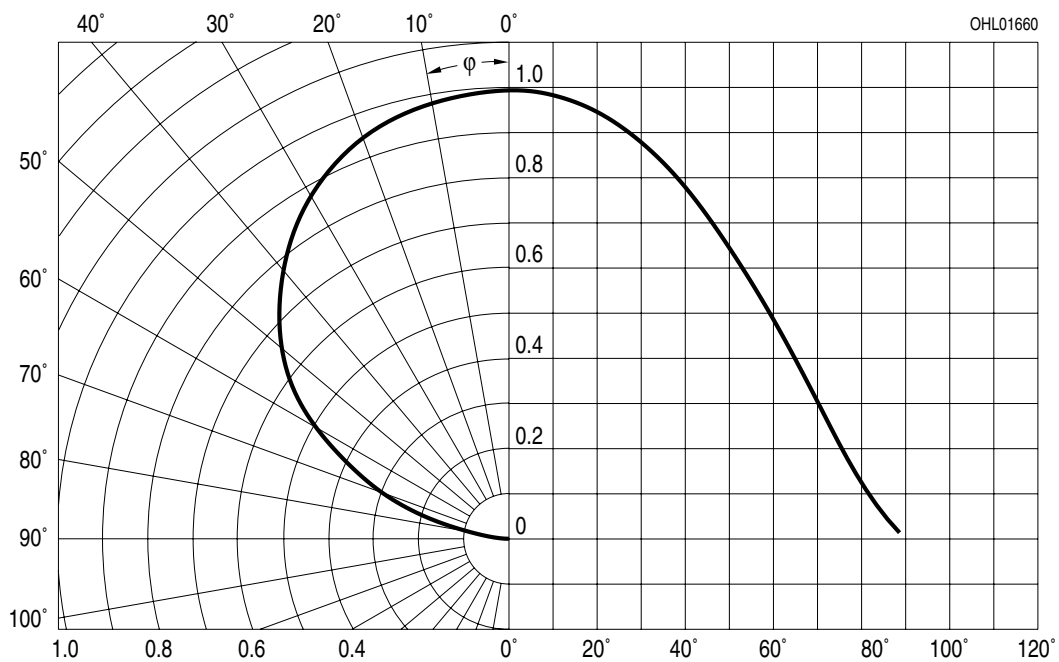

Forward current 1), 2)

- green: $I_F = f(V_F)$; single pulse; $t_p = 100 \mu s$

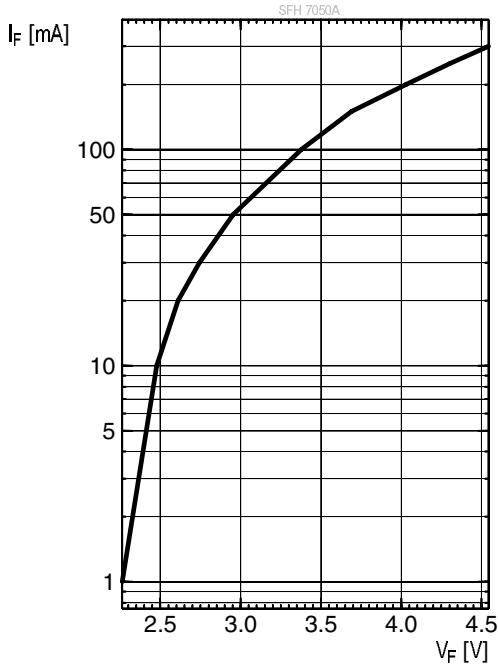

Forward current 1), 2)

- red: $I_F = f(V_F)$; single pulse; $t_p = 100 \mu s$

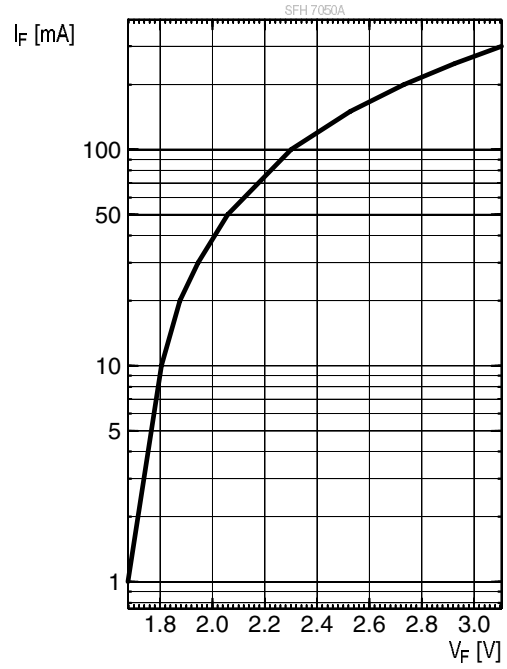

Forward current 1), 2)

- infrared (940 nm): $I_F = f(V_F)$; single pulse; $t_p = 100 \mu s$

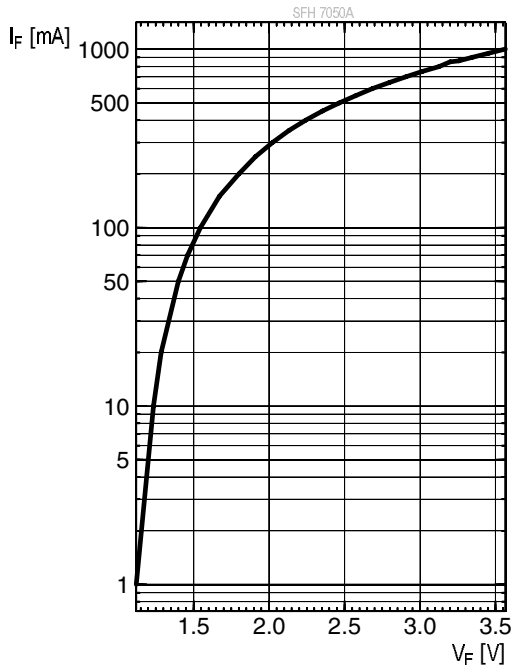

Relative Total Radiant Flux 1), 2)

- green: $\Phi_e / \Phi_e(20mA) = f(I_F)$; single pulse; $t_p = 100 \mu s$

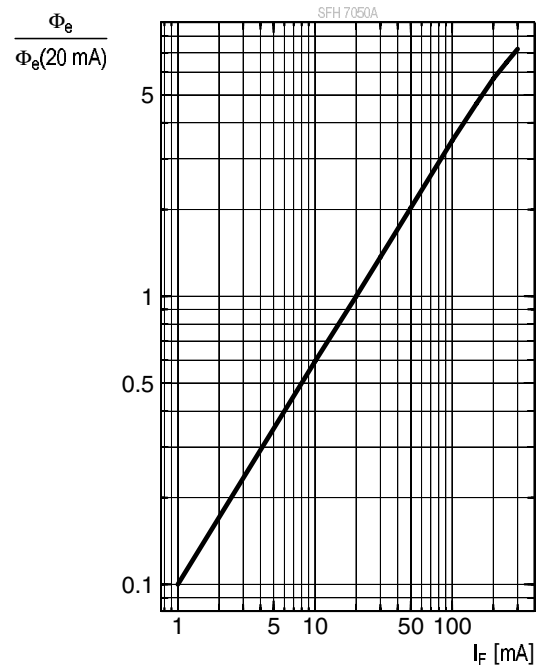

Relative Total Radiant Flux 1), 2)

• red: $\Phi_e / \Phi_e(20\text{mA}) = f(I_F)$; single pulse; $t_p = 100 \mu\text{s}$

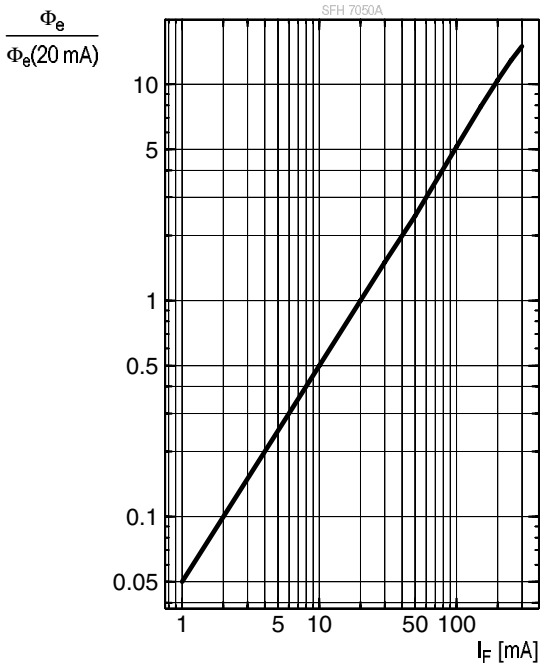

Relative Total Radiant Flux 1), 2)

• infrared (940 nm): $\Phi_e / \Phi_e(20\text{mA}) = f(I_F)$; s. p.; $t_p = 100 \mu\text{s}$

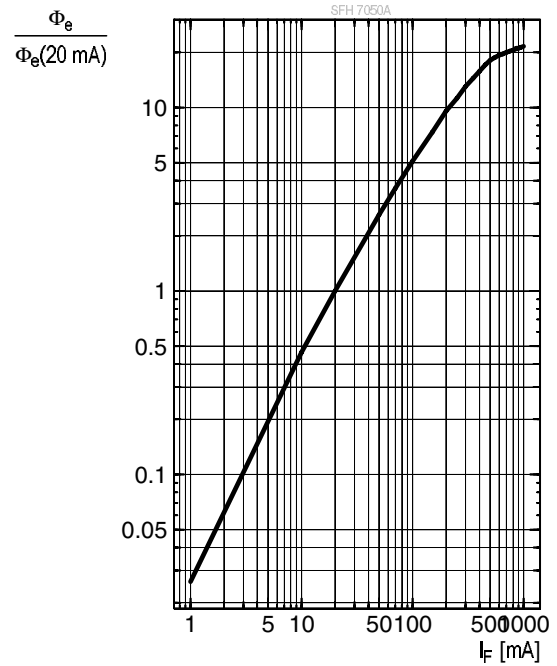

Photocurrent 1), 2)

■ photodiode: $I_p = f(E_e)$; $V_R = 5 \text{ V}$

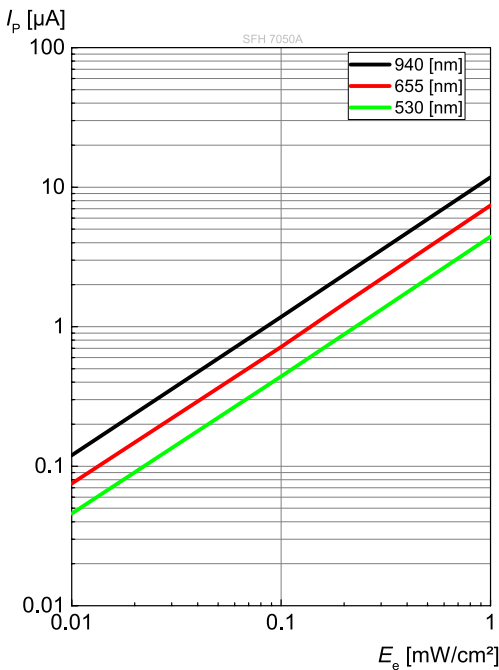

Dark Current 1), 2)

■ photodiode: $I_R = f(V_R)$; $E = 0$

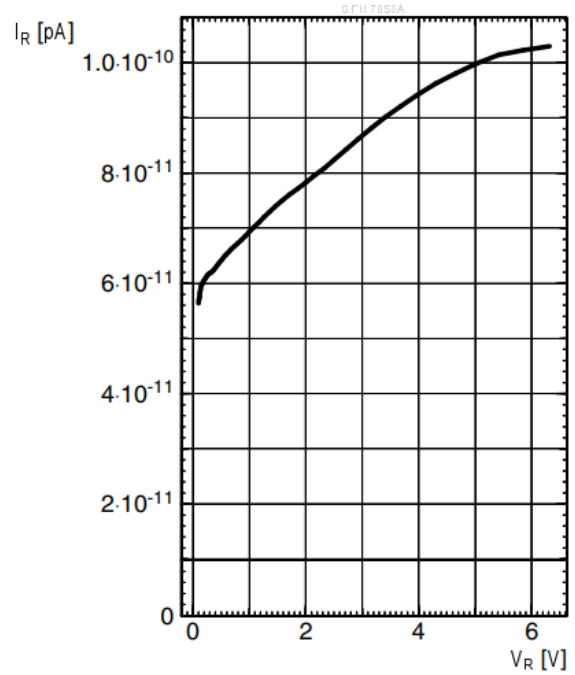

Capacitance 1), 2)

■ photodiode: $C = f(V_R)$; $f = 1\text{MHz}$; $E = 0$

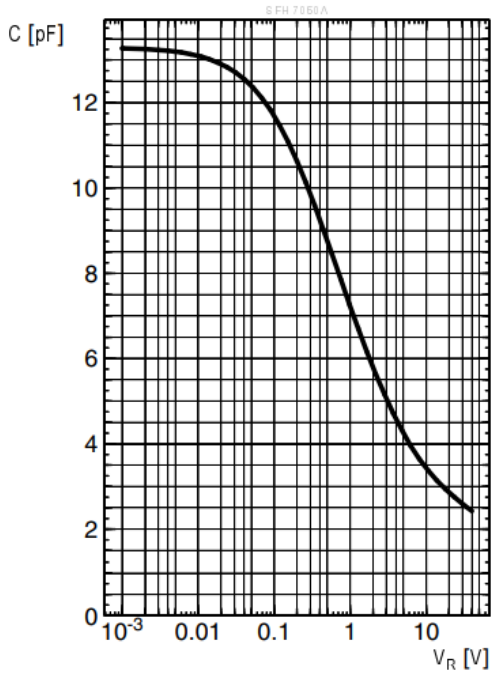

Max. Permissible Forward Current

● green: $I_F = f(T_A)$; $R_{th_{ja}} = 160\text{K} / \text{W}$

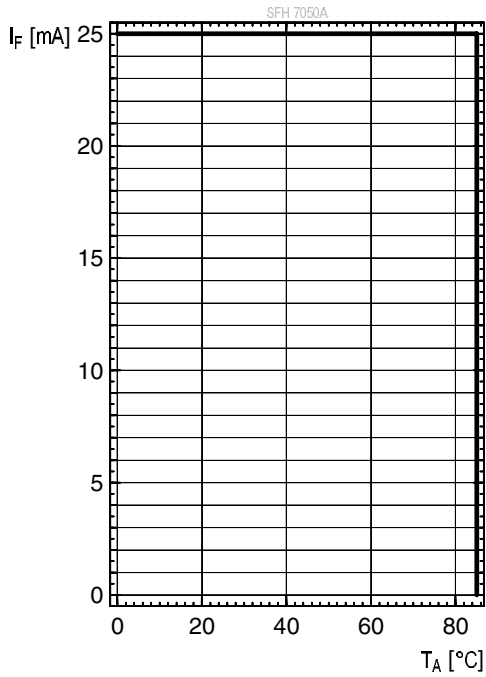

Max. Permissible Forward Current

● red: $I_F = f(T_A)$; $R_{th_{ja}} = 320\text{K} / \text{W}$

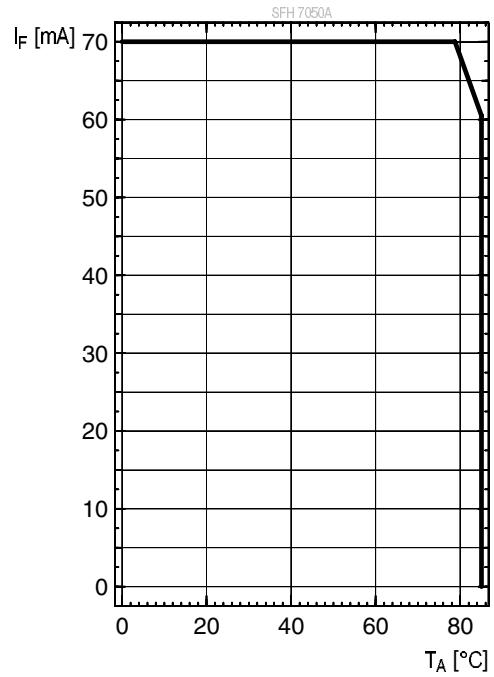

Max. Permissible Forward Current

- infrared (940 nm): $I_F = f(T_A)$; $R_{th_{ja}} = 230K / W$

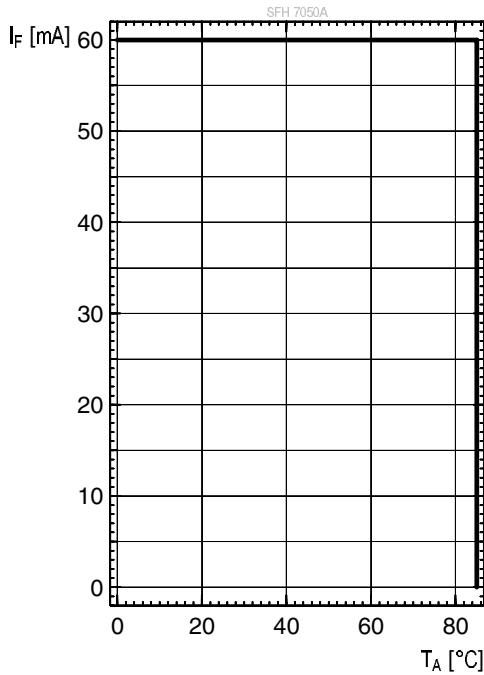

Permissible Pulse Handling Capability

- green: $I_F = f(t_p)$; $D = \text{parameter}$; $T_A = 25^\circ C$

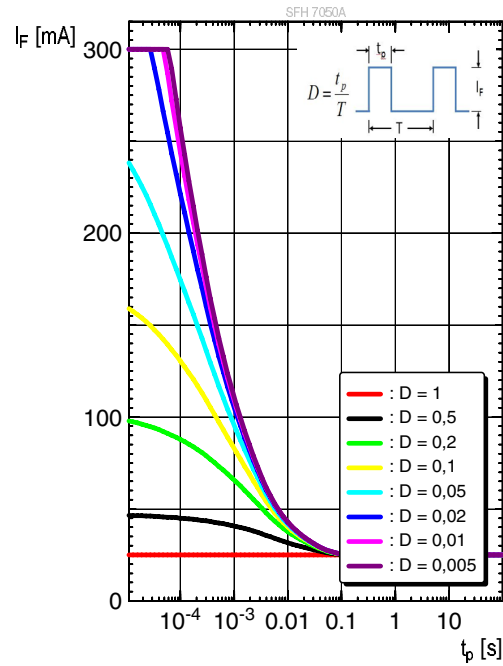

Permissible Pulse Handling Capability

- red: $I_F = f(t_p)$; $D = \text{parameter}$; $T_A = 25^\circ C$

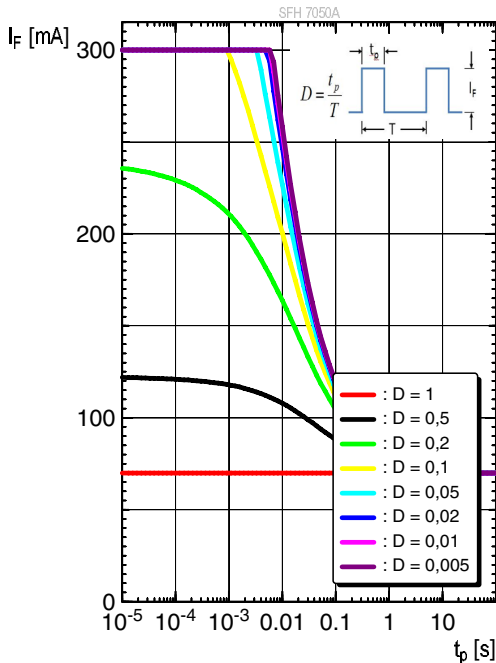

Permissible Pulse Handling Capability

- infrared (940 nm): $I_F = f(t_p)$; $D = \text{parameter}$; $T_A = 25^\circ C$

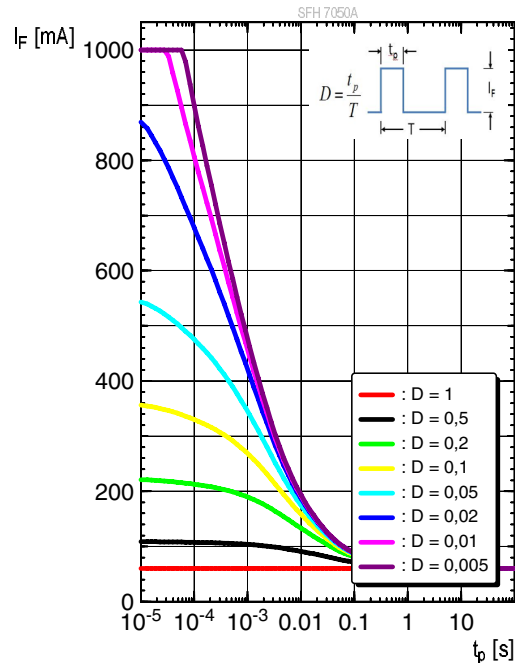

Permissible Pulse Handling Capability

• green: $I_F = f(t_p)$; $D =$ parameter; $T_A = 85^\circ\text{C}$

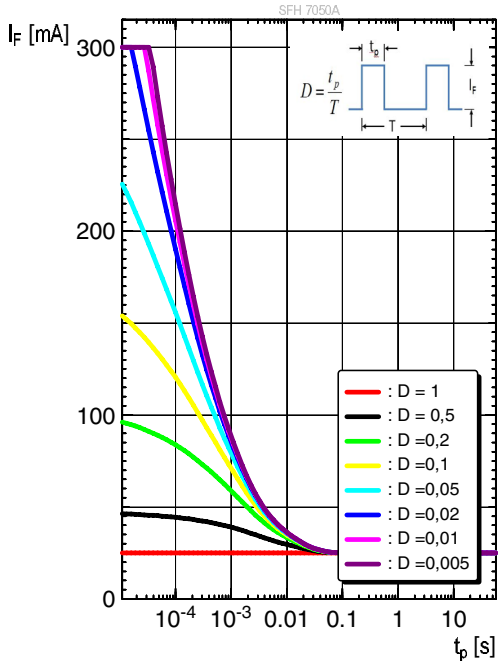

Permissible Pulse Handling Capability

• red: $I_F = f(t_p)$; $D =$ parameter; $T_A = 85^\circ\text{C}$

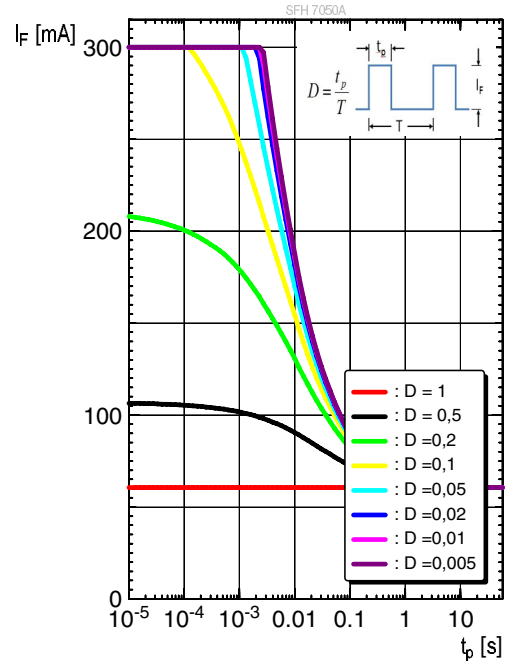

Permissible Pulse Handling Capability

• infrared (940 nm): $I_F = f(t_p)$; $D =$ parameter; $T_A = 85^\circ\text{C}$

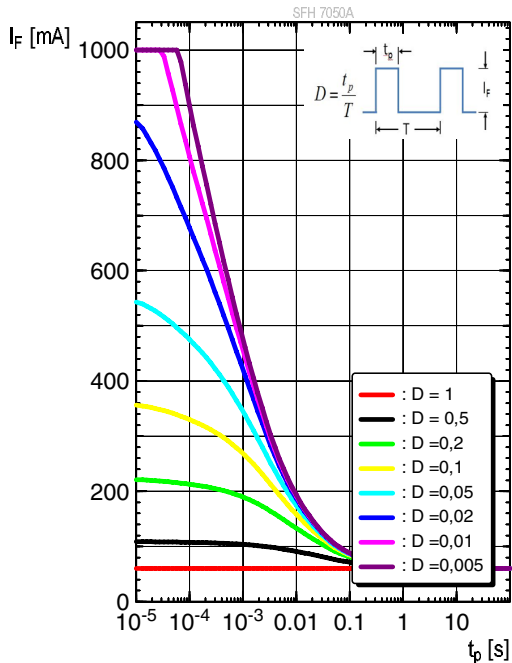

Dimensional Drawing ³⁾

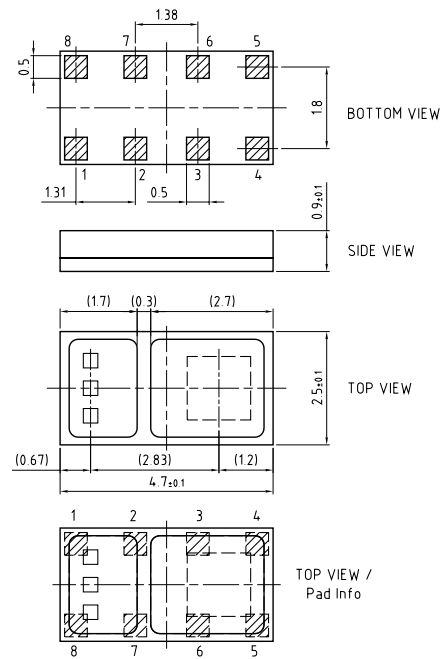

C63062-A4430-A1-01

Further Information:

Approximate Weight: 18.0 mg

Recommended Solder Pad ³⁾

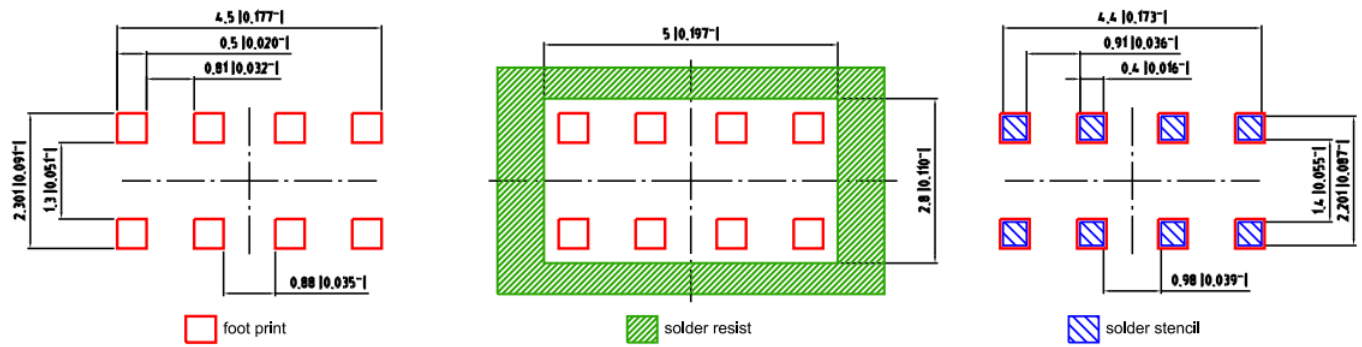

Component Location on Pad

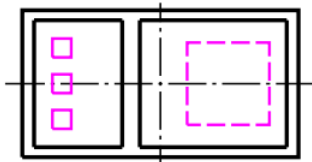

E062 3010 172-01

Reflow Soldering Profile

Product complies to MSL Level 4 acc. to JEDEC J-STD-020E

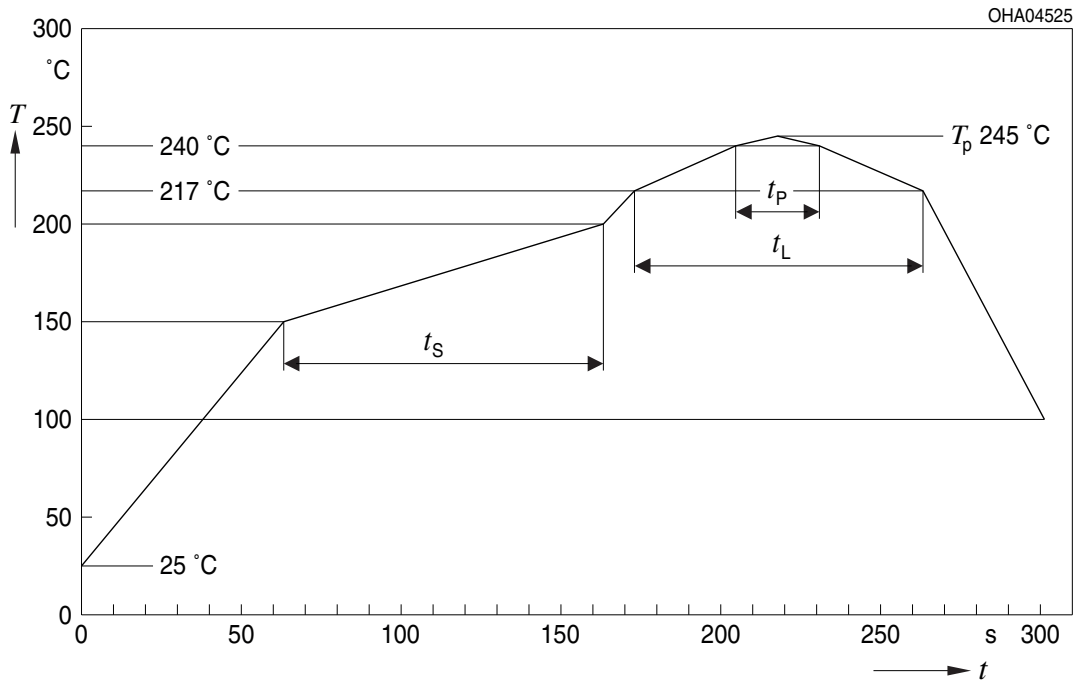

Profile Feature	Symbol	Pb-Free (SnAgCu) Assembly			Unit
		Minimum	Recommendation	Maximum	
Ramp-up rate to preheat ^{*)} 25 °C to 150 °C			2	3	K/s
Time t_s T_{Smin} to T_{Smax}	t_s	60	100	120	s
Ramp-up rate to peak ^{*)} T_{Smax} to T_p			2	3	K/s
Liquidus temperature	T_L		217		°C
Time above liquidus temperature	t_L		80	100	s
Peak temperature	T_p		245	260	°C
Time within 5 °C of the specified peak temperature $T_p - 5$ K	t_p	10	20	30	s
Ramp-down rate* T_p to 100 °C			3	6	K/s
Time 25 °C to T_p				480	s

All temperatures refer to the center of the package, measured on the top of the component
^{*} slope calculation DT/Dt : Dt max. 5 s; fulfillment for the whole T-range

Taping ³⁾

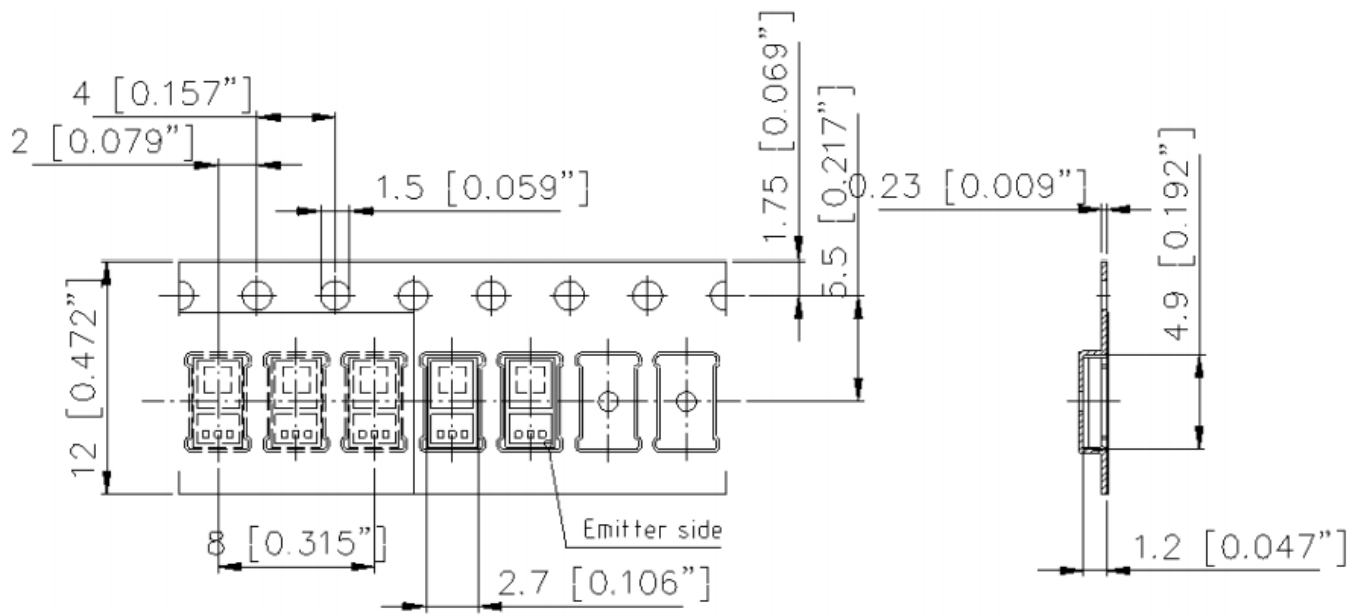

Tape and Reel ⁴⁾

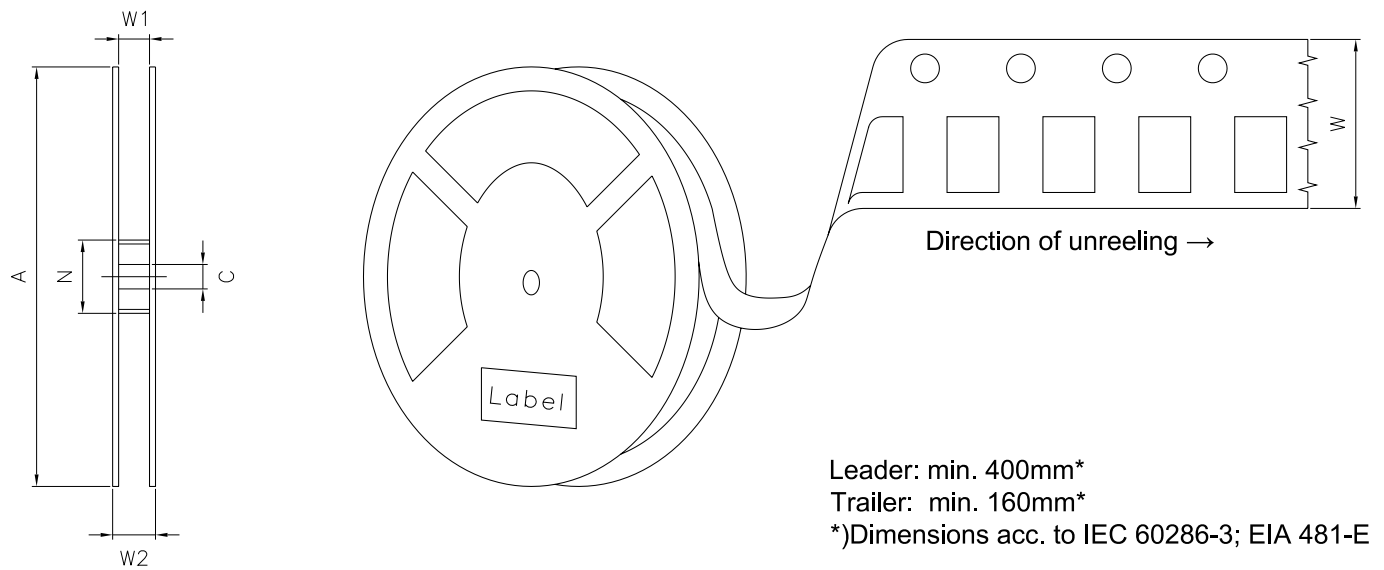

Reel Dimensions

A	W	N _{min}	W ₁	W _{2max}	Pieces per PU
180 mm	12 + 0.3 / - 0.1 mm	60 mm	12.4 + 2 mm	18.4 mm	3000

Barcode-Product-Label (BPL)

OSRAM Opto Semiconductors LX XXXX BIN1: XX-XX-X-XXX-X

RoHS Compliant

(6P) BATCH NO: 1234567890

(1T) LOT NO: 1234567890 (9D) D/C: 1234

(X) PROD NO: 123456789(Q)QTY: 9999 (G) GROUP: XX-XX-X-X

ML Temp ST
X XXX °C X

Pack: RXX
DEMY XXX
X_X123_1234.1234 X

OHA04563

Dry Packing Process and Materials ³⁾

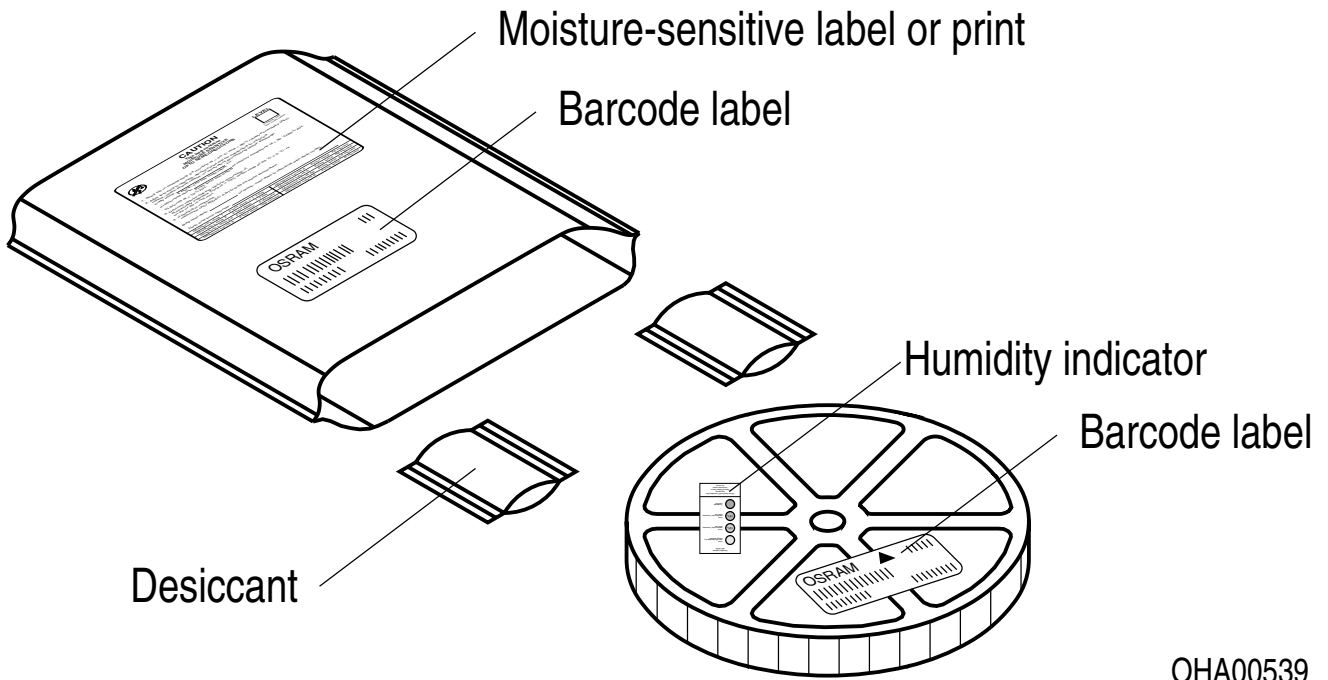

OHA00539

Disclaimer

Attention please!

The information describes the type of component and shall not be considered as assured characteristics. Terms of delivery and rights to change design reserved. Due to technical requirements components may contain dangerous substances.

For information on the types in question please contact our Sales Organization.

If printed or downloaded, please find the latest version on our website.

Packing

Please use the recycling operators known to you. We can also help you – get in touch with your nearest sales office. By agreement we will take packing material back, if it is sorted. You must bear the costs of transport. For packing material that is returned to us unsorted or which we are not obliged to accept, we shall have to invoice you for any costs incurred.

Product and functional safety devices/applications or medical devices/applications

Our components are not developed, constructed or tested for the application as safety relevant component or for the application in medical devices.

Our products are not qualified at module and system level for such application.

In case buyer – or customer supplied by buyer – considers using our components in product safety devices/ applications or medical devices/applications, buyer and/or customer has to inform our local sales partner immediately and we and buyer and /or customer will analyze and coordinate the customer-specific request between us and buyer and/or customer.

Glossary

- 1) **Typical Values:** Due to the special conditions of the manufacturing processes of semiconductor devices, the typical data or calculated correlations of technical parameters can only reflect statistical figures. These do not necessarily correspond to the actual parameters of each single product, which could differ from the typical data and calculated correlations or the typical characteristic line. If requested, e.g. because of technical improvements, these typ. data will be changed without any further notice.
- 2) **Testing temperature:** $T_A = 25^\circ\text{C}$ (unless otherwise specified)
- 3) **Tolerance of Measure:** Unless otherwise noted in drawing, tolerances are specified with ± 0.1 and dimensions are specified in mm.
- 4) **Tape and Reel:** All dimensions and tolerances are specified acc. IEC 60286-3 and specified in mm.
- 5) **Reverse Operation:** This product is intended to be operated applying a forward current within the specified range. Applying any continuous reverse bias or forward bias below the voltage range of light emission shall be avoided because it may cause migration which can change the electro-optical characteristics or damage the LED.
- 6) **Wavelength:** The wavelengths are measured with a tolerance of ± 1 nm.
- 7) **Brightness:** The brightness values are measured with a tolerance of $\pm 11\%$.
- 8) **Forward Voltage:** The forward voltages are measured with a tolerance of ± 0.1 V.

Revision History

Version	Date	Change
1.0	2022-01-26	Initial Version
1.1	2022-06-20	New Layout



EU RoHS and China RoHS compliant product

此产品符合欧盟 RoHS 指令的要求；
按照中国的相关法规和标准，
不含有毒有害物质或元素。

Published by ams-OSRAM AG

Tobelbader Strasse 30, 8141 Premstaetten, Austria

Phone +43 3136 500-0

ams-osram.com

© All rights reserved

am 

OSRAM

X-ON Electronics

Largest Supplier of Electrical and Electronic Components

Click to view similar products for [Biometric Sensors](#) category:

Click to view products by [Osram](#) manufacturer:

Other Similar products are found below :

[NPC-120T](#) [BH1792GLC-E2](#) [SFH 7070](#) [AFE4410YZT](#) [20-0584](#) [20-0599](#) [20-0696](#) [NPC-100T](#) [AS7026GG](#) [AS7026GG-COLM](#) [AS7038GB-](#)
[COLM](#) [ZF-BP3-SH](#) [MAX30101EFD+T](#) [MAX30102EFD+T](#) [MAX86141ENP+T](#) [B5T-001001\(G\)](#) [B5T-007001-010](#) [B5T-007001-020](#)
[MAX30034CUA+](#) [SFH 7050A](#) [SFH 7074](#) [XB5S6B2M12](#) [SFH 7072](#) [SEN-12969](#) [10184000-01](#)