

# OSRAM SFH 7060A

## Datasheet

Published by **ams-OSRAM AG**

Tobelbader Strasse 30, 8141 Premstaetten, Austria

Phone +43 3136 500-0

[ams-osram.com](http://ams-osram.com)

© All rights reserved



BIOFY®

# SFH 7060A

Biomonitoring Sensor



## Applications

- Digital Diagnostic Devices
- Vital Sign Monitoring

## Features

- ESD: 2 kV acc. to ANSI/ESDA/JEDEC JS-001 (HBM, Class 2)
- Multi chip package featuring three green, one red, one infrared emitter and one detector
- Small package: (WxDxH) 7.2 mm x 2.5 mm x 0.9 mm
- Light Barrier to block optical crosstalk
- Improved geometry for optimized signal quality

---

## Ordering Information

Type	Ordering Code
SFH 7060A	Q65113A3205
● green	
● red	
● infrared (940 nm)	
■ photodiode	

---

## Pin configuration

Pin	Name	Function
1	Red	Red LED Anode
2	Red	Red LED Cathode
3	Green 1	Green LED 1 Cathode
4	Green 1	Green LED 1 Anode
5	Green 2	Green LED 2 Anode
6	PD	Photodiode Anode
7	PD	Photodiode Cathode
8	Green 2	Green LED 2 Cathode
9	Green 3	Green LED 3 Anode
10	Green 3	Green LED 3 Cathode
11	IR	Infrared LED Cathode
12	IR	Infrared LED Anode

Top view

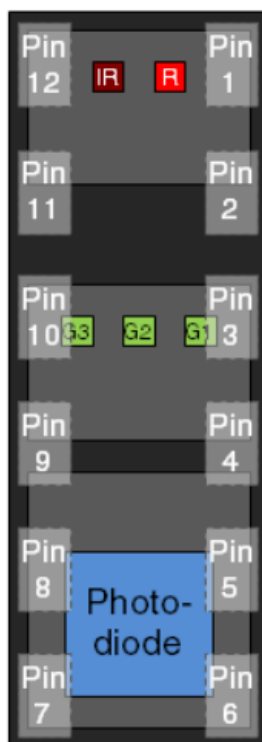

## Block diagramm

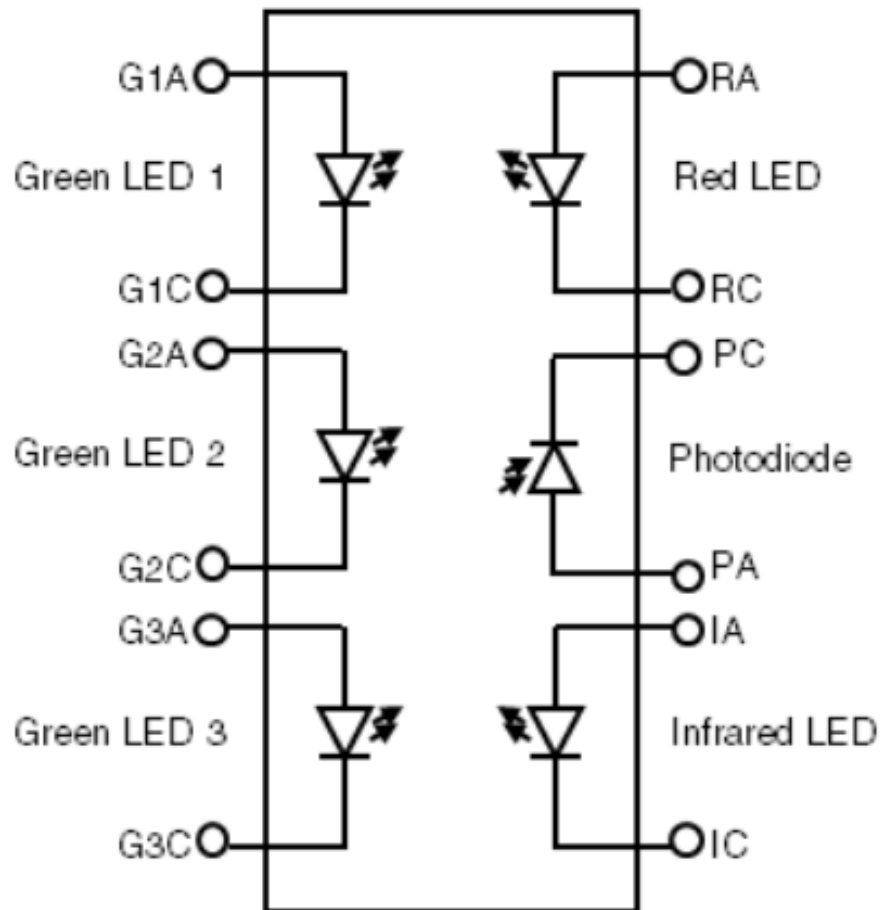

## Maximum Ratings

$T_A = 25\text{ °C}$

Parameter	Symbol		Values
Operating temperature range	$T_{op}$	min.	-40 °C
		max.	85 °C
Storage temperature range	$T_{stg}$	min.	-40 °C
		max.	85 °C
ESD withstand voltage acc. to ANSI/ESDA/JEDEC JS-001 - HBM	$V_{ESD}$	max.	2 kV
<b>Green Emitter</b>			
Reverse voltage	$V_R$		not designed for reverse operation
Forward current single operation	$I_F(DC)$	max.	25 mA
Forward current all three green emitters operation	$I_F(DC)$	max.	15 mA
Forward current pulsed $t_p \leq 60\ \mu s$ ; $D = 0.005$	$I_F\ pulse$	max.	300 mA
<b>Red Emitter</b>			
Reverse voltage <sup>5)</sup>	$V_R$	max.	12 V
Forward current	$I_F(DC)$	max.	70 mA
Forward current pulsed $t_p \leq 6\ ms$ ; $D = 0.005$	$I_F\ pulse$	max.	300 mA
<b>Infrared Emitter</b>			
Reverse voltage <sup>5)</sup>	$V_R$	max.	5 V
Forward current	$I_F(DC)$	max.	60 mA
Forward current pulsed $t_p \leq 60\ \mu s$ ; $D = 0.005$	$I_F\ pulse$	max.	1 A
<b>Photodiode</b>			
Reverse voltage	$V_R$	max.	6 V

## Characteristics

$T_A = 25\text{ °C}$

Parameter	Symbol		Values
<b>Green Emitter (single emitter)</b>			
Peak wavelength $I_F = 20\text{ mA}$	$\lambda_{\text{peak}}$	typ.	525 nm
Centroid Wavelength <sup>6)</sup> $I_F = 20\text{ mA}$	$\lambda_{\text{centroid}}$	min.	520 nm
		typ.	530 nm
		max.	540 nm
Spectral bandwidth at 50% of $I_{\text{max}}$ $I_F = 20\text{ mA}$	$\Delta\lambda$	typ.	34 nm
Half angle	$\varphi$	typ.	$\pm 60\text{ °}$
Rise time (10%/ 90%) $I_F = 100\text{ mA}; t_p = 16\text{ }\mu\text{s}; R_L = 50\text{ }\Omega$	$t_r$	typ.	32 ns
Fall time (10%/ 90%) $I_F = 100\text{ mA}; t_p = 16\text{ }\mu\text{s}; R_L = 50\text{ }\Omega$	$t_f$	typ.	80 ns
Forward voltage <sup>8)</sup> $I_F = 20\text{ mA}$	$V_F$	typ.	2.6 V
		max.	3.1 V
Reverse current $V_R = 5\text{ V}$	$I_R$		not designed for reverse operation
Radiant intensity $I_F = 20\text{ mA}; t_p = 20\text{ ms}$	$I_e$	typ.	1.9 mW / sr
Total radiant flux $I_F = 20\text{ mA}; t_p = 20\text{ ms}$	$\Phi_e$	typ.	4.5 mW
Temperature coefficient of wavelength $I_F = 20\text{ mA}; -10\text{ °C} \leq T \leq 100\text{ °C}$	$TC_\lambda$	typ.	0.03 nm / K
Temperature coefficient of voltage $I_F = 20\text{ mA}; -10\text{ °C} \leq T \leq 100\text{ °C}$	$TC_V$	typ.	-3.6 mV / K
Thermal resistance junction ambient real	$R_{thja}$	max.	160 K/W

## Characteristics

$T_A = 25\text{ °C}$

Parameter	Symbol		Values
<b>Red Emitter</b>			
Peak wavelength $I_F = 20\text{ mA}$	$\lambda_{\text{peak}}$	typ.	660 nm
Centroid Wavelength <sup>6)</sup> $I_F = 20\text{ mA}$	$\lambda_{\text{centroid}}$	min.	652 nm
		typ.	655 nm
		max.	658 nm
Spectral bandwidth at 50% $I_{\text{max}}$ $I_F = 20\text{ mA}$	$\Delta\lambda$	typ.	17 nm
Half angle	$\varphi$	typ.	$\pm 60\text{ °}$
Rise time (10%/ 90%) $I_F = 100\text{ mA}; t_p = 16\text{ }\mu\text{s}; R_L = 50\text{ }\Omega$	$t_r$	typ.	24 ns
Fall time (10%/ 90%) $I_F = 100\text{ mA}; t_p = 16\text{ }\mu\text{s}; R_L = 50\text{ }\Omega$	$t_f$	typ.	24 ns
Forward voltage <sup>8)</sup> $I_F = 20\text{ mA}$	$V_F$	min.	1.7 V
		typ.	1.9 V
		max.	2.2 V
Reverse current $V_R = 12\text{ V}$	$I_R$		not designed for reverse operation
Radiant intensity $I_F = 20\text{ mA}; t_p = 20\text{ ms}$	$I_e$	typ.	2.9 mW / sr
Total radiant flux $I_F = 20\text{ mA}; t_p = 20\text{ ms}$	$\Phi_e$	typ.	7.3 mW
Temperature coefficient of wavelength $I_F = 20\text{ mA}; -10\text{ °C} \leq T \leq 100\text{ °C}$	$TC_\lambda$	typ.	0.13 nm / K
Thermal resistance junction ambient real	$R_{thja}$	max.	320 K/W



## Characteristics

$T_A = 25\text{ °C}$

Parameter	Symbol		Values
<b>Infrared Emitter</b>			
Peak wavelength $I_F = 20\text{ mA}; t_p = 20\text{ ms}$	$\lambda_{\text{peak}}$	typ.	950 nm
Centroid Wavelength <sup>6)</sup> $I_F = 20\text{ mA}; t_p = 20\text{ ms}$	$\lambda_{\text{centroid}}$	min.	930 nm
		typ.	940 nm
		max.	950 nm
Spectral bandwidth at 50% $I_{\text{max}}$ $I_F = 20\text{ mA}; t_p = 20\text{ ms}$	$\Delta\lambda$	typ.	42 nm
Half angle	$\varphi$	typ.	$\pm 60\text{ °}$
Rise time (10%/ 90%) $I_F = 100\text{ mA}; t_p = 16\text{ }\mu\text{s}; R_L = 50\text{ }\Omega$	$t_r$	typ.	16 ns
Fall time (10%/ 90%) $I_F = 100\text{ mA}; t_p = 16\text{ }\mu\text{s}; R_L = 50\text{ }\Omega$	$t_f$	typ.	16 ns
Forward voltage <sup>8)</sup> $I_F = 20\text{ mA}; t_p = 20\text{ ms}$	$V_F$	typ.	1.3 V
		max.	1.7 V
Reverse current $V_R = 5\text{ V}$	$I_R$		Not designed for reverse operation
Radiant intensity $I_F = 20\text{ mA}; t_p = 20\text{ ms}$	$I_e$	typ.	2 mW / sr
Total radiant flux $I_F = 20\text{ mA}; t_p = 20\text{ ms}$	$\Phi_e$	typ.	5.3 mW
Temperature coefficient of brightness $I_F = 20\text{ mA}; t_p = 20\text{ ms}$	$TC_I$	typ.	-0.3 % / K
Temperature coefficient of voltage $I_F = 20\text{ mA}; t_p = 20\text{ ms}$	$TC_V$	typ.	-0.8 mV / K
Temperature coefficient of wavelength $I_F = 20\text{ mA}; t_p = 20\text{ ms}$	$TC_\lambda$	typ.	0.25 nm / K
Thermal resistance junction ambient real	$R_{thja}$	max.	230 K/W

## Characteristics

$T_A = 25\text{ °C}$

Parameter	Symbol		Values
<b>Photodiode</b>			
Wavelength of max. sensitivity	$\lambda_{S\text{ max}}$	typ.	900 nm
Spectral range of sensitivity	$\lambda_{10\%}$	typ.	400 ... 1100 nm
Photocurrent $E_e = 0.1\text{ mW/cm}^2$ ; $\lambda = 535\text{ nm}$ ; $V_R = 5\text{ V}$	$I_P$	typ.	0.5 $\mu\text{A}$
Photocurrent $E_e = 0.1\text{ mW/cm}^2$ ; $\lambda = 655\text{ nm}$ ; $V_R = 5\text{ V}$	$I_P$	typ.	0.75 $\mu\text{A}$
Photocurrent $E_e = 0.1\text{ mW/cm}^2$ ; $\lambda = 940\text{ nm}$ ; $V_R = 5\text{ V}$	$I_P$	typ.	1.22 $\mu\text{A}$
Radiant sensitive area	A	typ.	1.51 mm <sup>2</sup>
Dimensions of active chip area	L x W	typ.	1.23 x 1.23 mm x mm
Dark current $V_R = 5\text{ V}$ ; $E = 0$	$I_R$	typ. max.	0.1 nA 25 nA
Spectral sensitivity of the chip $\lambda = 535\text{ nm}$	$S_\lambda$	typ.	0.34 A / W
Open-circuit voltage $E_e = 0.1\text{ mW/cm}^2$ ; $\lambda = 535\text{ nm}$	$V_O$	typ.	510 mV
Rise time (10%/ 90%) $V_R = 3.3\text{ V}$ ; $R_L = 50\ \Omega$ ; $\lambda = 535\text{ nm}$	$t_r$	typ.	47 ns
Fall time (10%/ 90%) $V_R = 3.3\text{ V}$ ; $R_L = 50\ \Omega$ ; $\lambda = 535\text{ nm}$	$t_f$	typ.	67 ns
Forward voltage $I_F = 10\text{ mA}$ ; $E = 0$	$V_F$	typ..	0.95 V
Capacitance $V_R = 0\text{ V}$ ; $f = 1\text{ MHz}$ ; $E = 0$	$C_0$	typ.	13.4 pF

### Relative Spectral Emission 1), 2)

- green:  $I_{e,rel} = f(\lambda)$ ;  $I_F = 20 \text{ mA}$ ;  $t_p = 20 \text{ ms}$

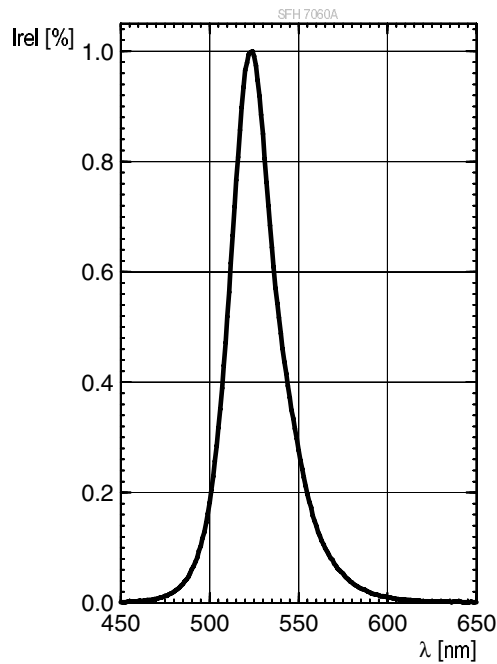

### Relative Spectral Emission 1), 2)

- red:  $I_{e,rel} = f(\lambda)$ ;  $I_F = 20 \text{ mA}$ ;  $t_p = 20 \text{ ms}$

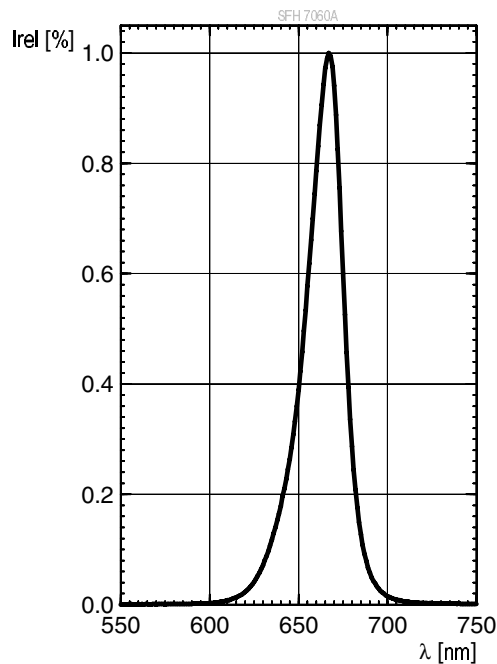

## Relative Spectral Emission <sup>1), 2)</sup>

- infrared (940 nm):  $I_{e,rel} = f(\lambda)$ ;  $I_F = 20 \text{ mA}$ ;  $t_p = 20 \text{ ms}$

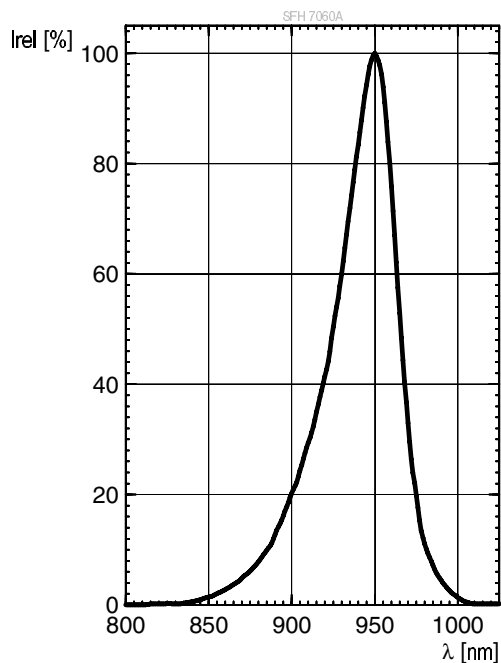

## Radiation Characteristics <sup>1), 2)</sup>

- true green/ hyper red/ infrared:  $I_{e,rel} = f(\varphi)$

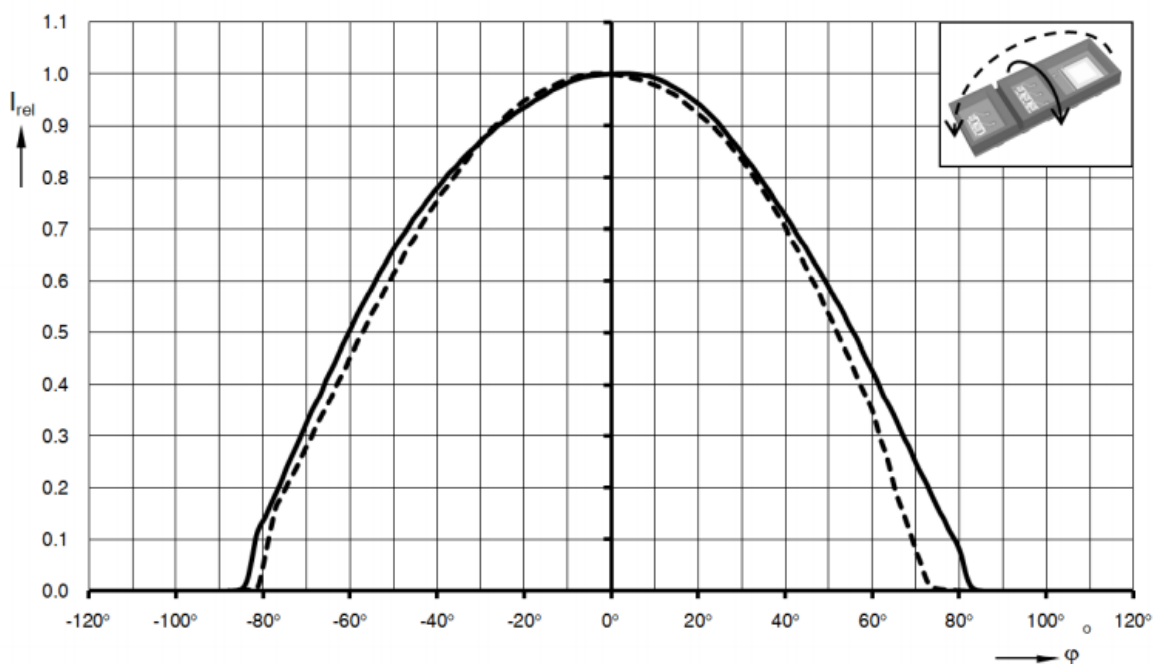

## Directional Characteristics <sup>1), 2)</sup>

■ photodiode:  $S_{rel} = f(\varphi)$

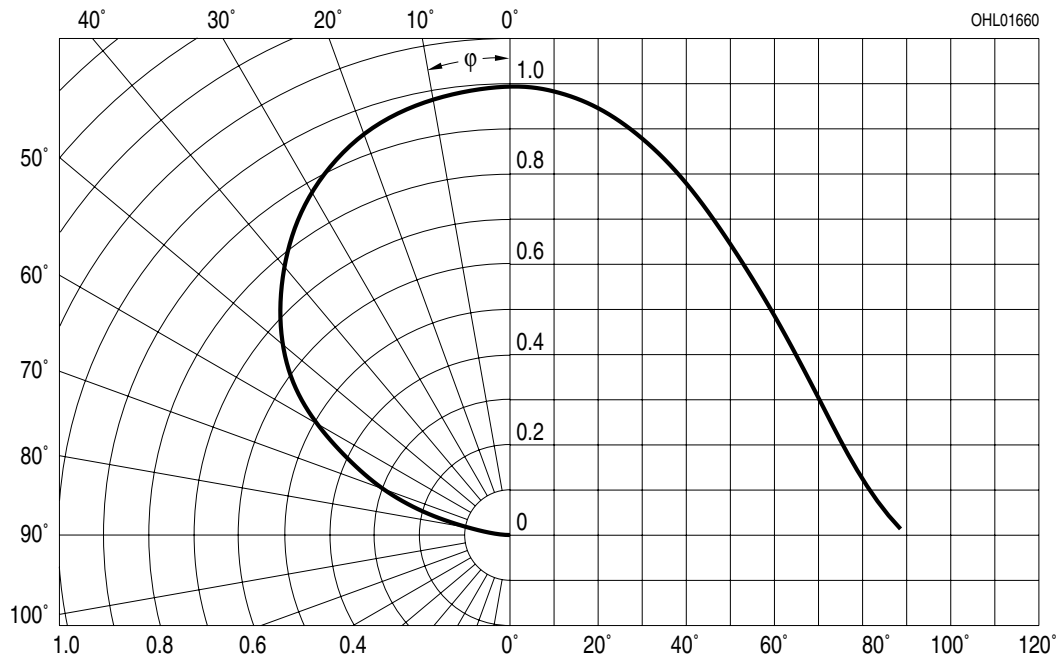

## Relative Spectral Sensitivity <sup>1), 2)</sup>

■ photodiode:  $S_{rel} = f(\lambda)$

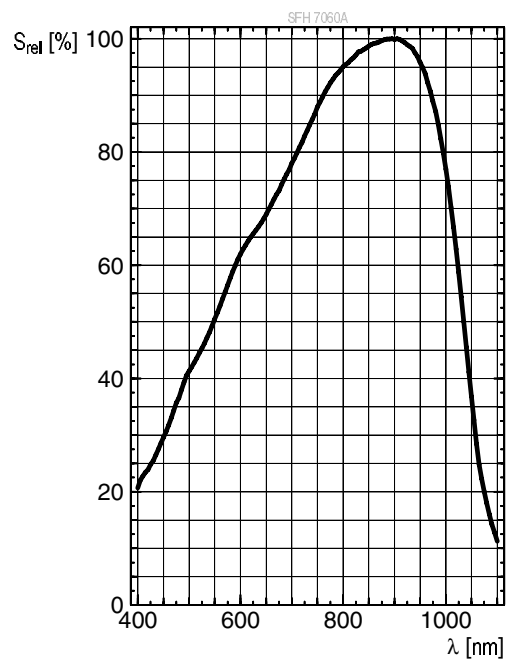

**Forward current** 1), 2)

- green:  $I_F = f(V_F)$ ; single pulse;  $t_p = 100 \mu s$

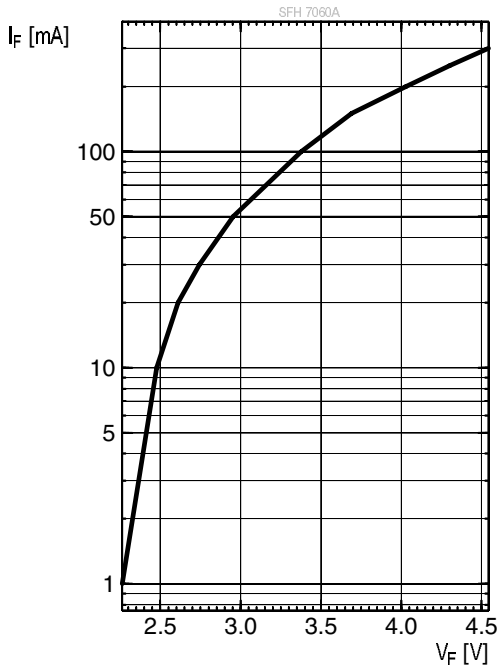

**Forward current** 1), 2)

- red:  $I_F = f(V_F)$ ; single pulse;  $t_p = 100 \mu s$

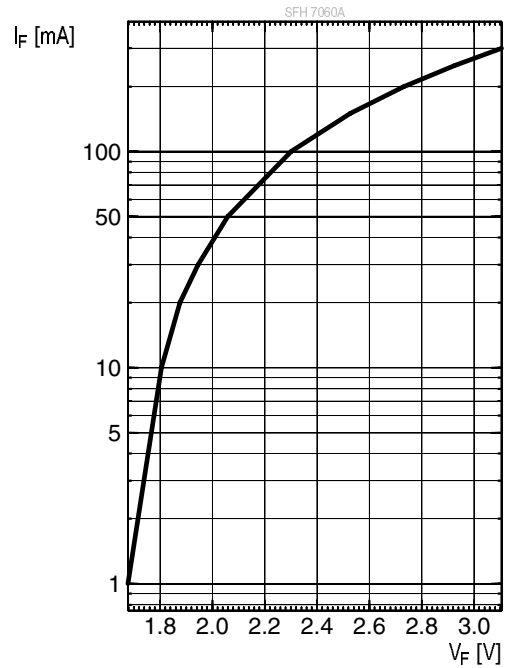

**Forward current** 1), 2)

- infrared (940 nm):  $I_F = f(V_F)$ ; single pulse;  $t_p = 100 \mu s$

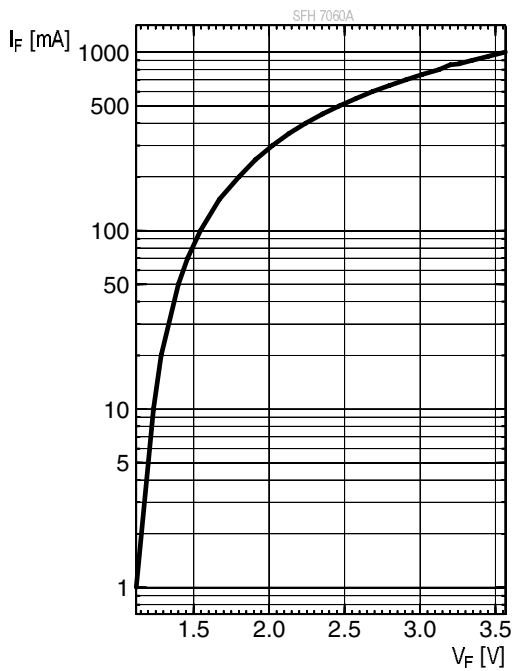

**Relative Total Radiant Flux** 1), 2)

- green:  $\Phi_e / \Phi_e(20mA) = f(I_F)$ ; single pulse;  $t_p = 100 \mu s$

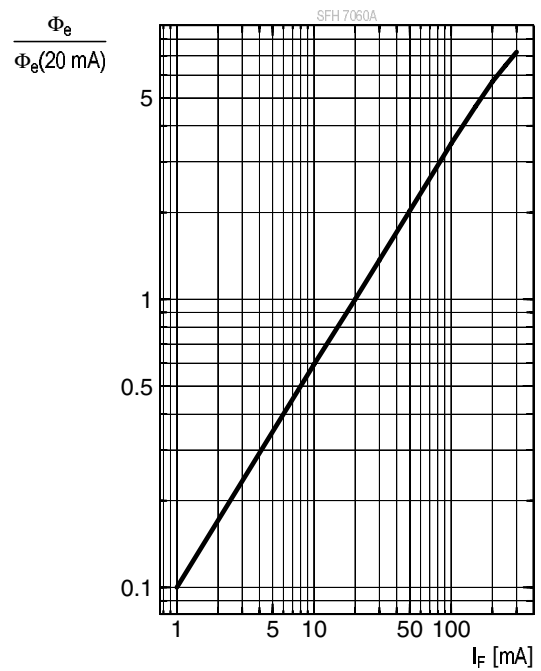

**Relative Total Radiant Flux** 1), 2)

• red:  $\Phi_e / \Phi_e(20\text{mA}) = f(I_F)$ ; single pulse;  $t_p = 100 \mu\text{s}$

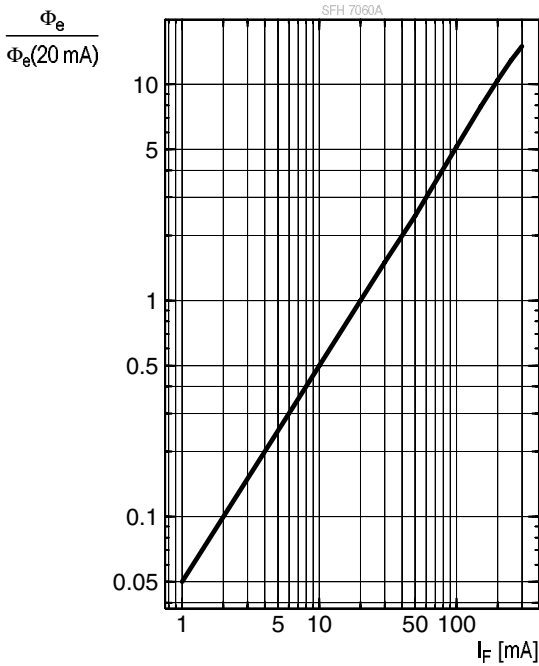

**Relative Total Radiant Flux** 1), 2)

• infrared (940 nm):  $\Phi_e / \Phi_e(20\text{mA}) = f(I_F)$ ; s. p.;  $t_p = 25 \mu\text{s}$

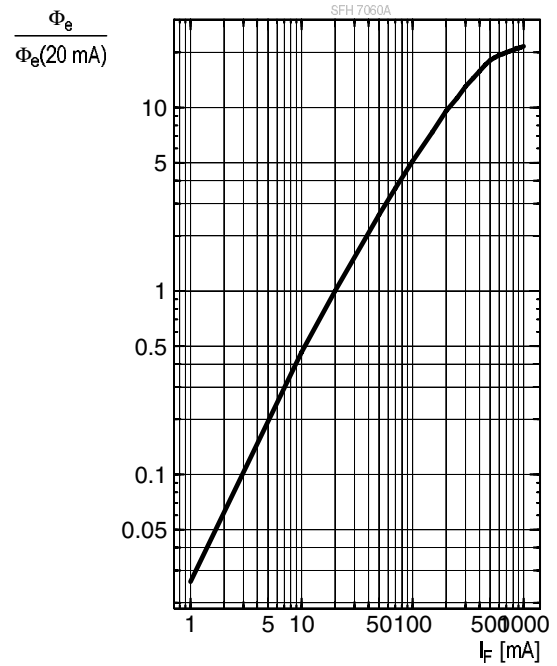

**Photocurrent** 1), 2)

■ photodiode:  $I_p = f(E_e)$ ;  $V_R = 5 \text{ V}$

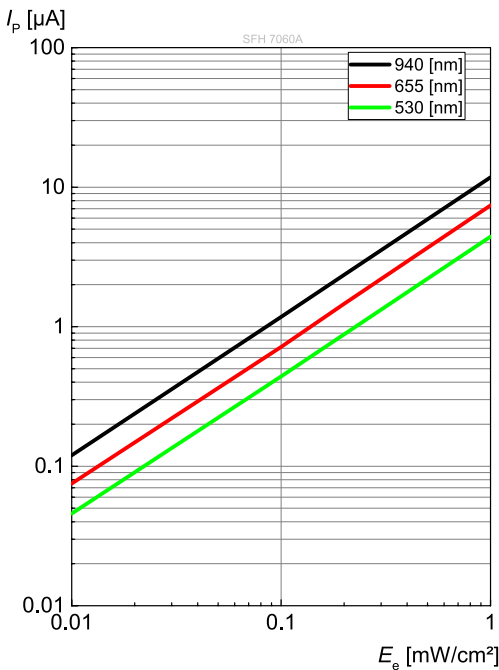

**Dark Current** 1), 2)

■ photodiode:  $I_R = f(V_R)$ ;  $E = 0$

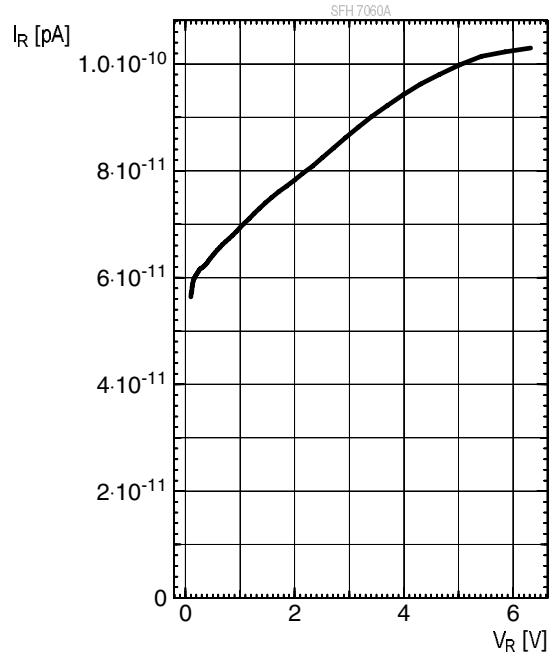

**Capacitance** <sup>1), 2)</sup>

■ photodiode:  $C = f(V_R)$ ;  $f = 1\text{MHz}$ ;  $E = 0$

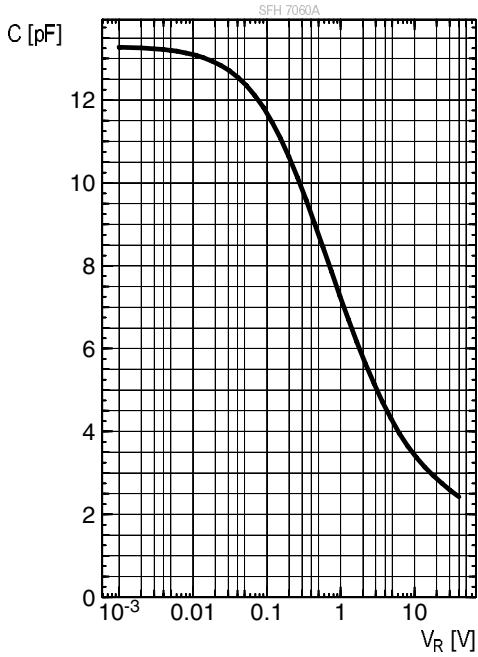

**Max. Permissible Forward Current**

● green:  $I_F = f(T_A)$ ;  $R_{th_{ja}} = 160\text{ K/W}$

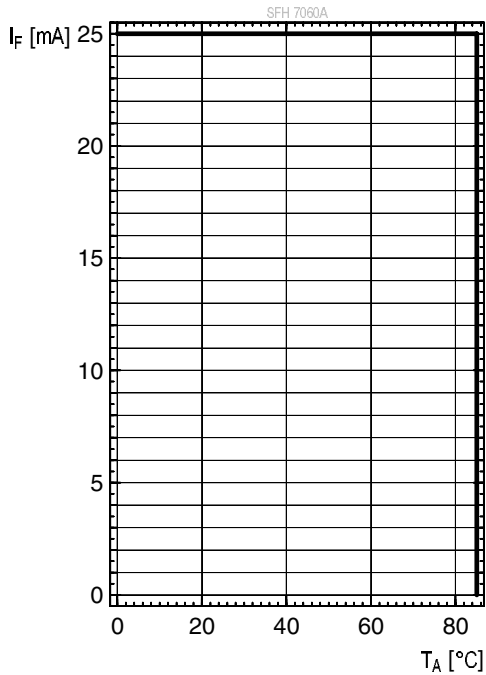

**Max. Permissible Forward Current**

● red:  $I_F = f(T_A)$ ;  $R_{th_{ja}} = 320\text{ K/W}$

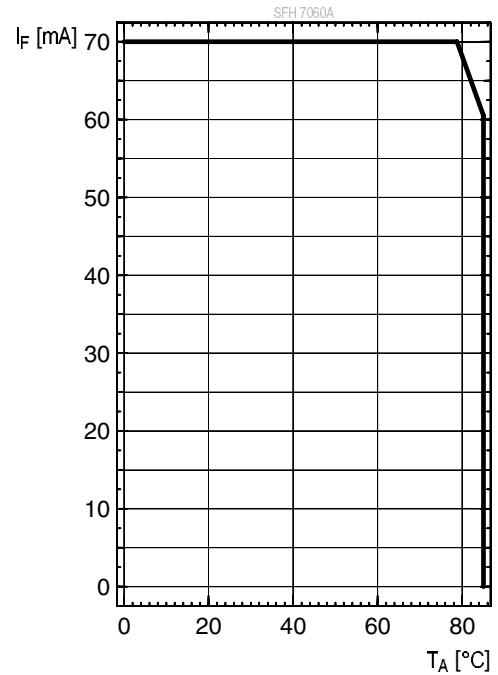



### Max. Permissible Forward Current

- infrared (940 nm):  $I_F = f(T_A)$ ;  $R_{th_{ja}} = 230 \text{ K/W}$

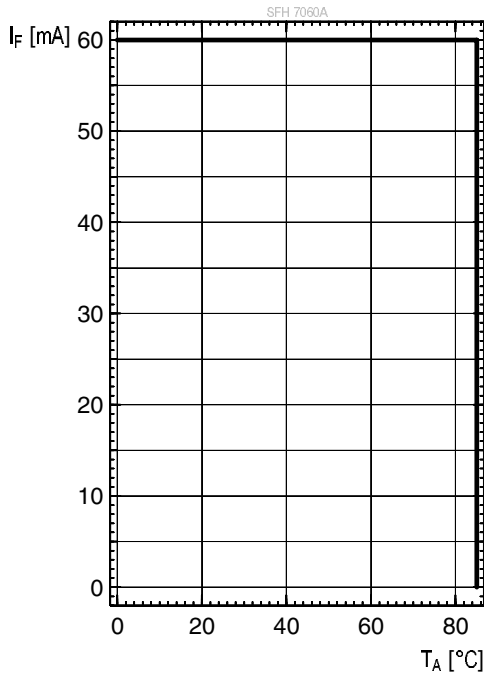

### Permissible Pulse Handling Capability

- green:  $I_F = f(t_p)$ ;  $D = \text{parameter}$ ;  $T_A = 25 \text{ °C}$

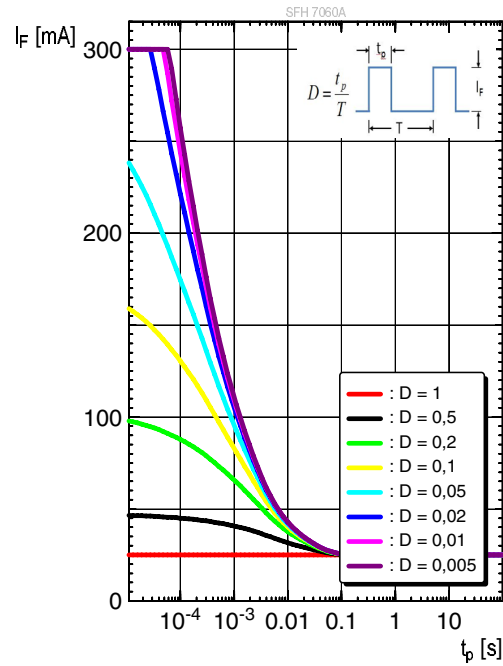

### Permissible Pulse Handling Capability

- red:  $I_F = f(t_p)$ ;  $D = \text{parameter}$ ;  $T_A = 25 \text{ °C}$

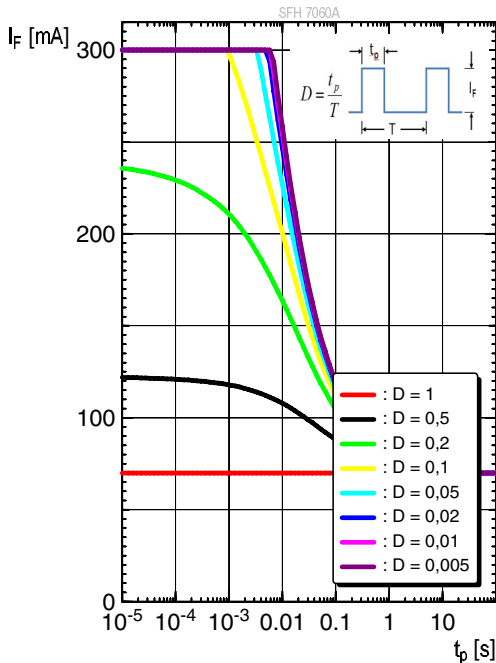

### Permissible Pulse Handling Capability

- infrared (940 nm):  $I_F = f(t_p)$ ;  $D = \text{parameter}$ ;  $T_A = 25 \text{ °C}$

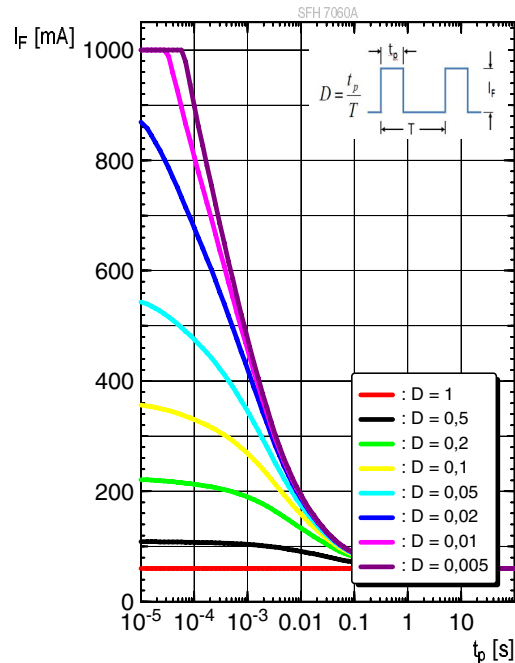

### Permissible Pulse Handling Capability

● green:  $I_F = f(t_p)$ ;  $D =$  parameter;  $T_A = 85\text{ °C}$

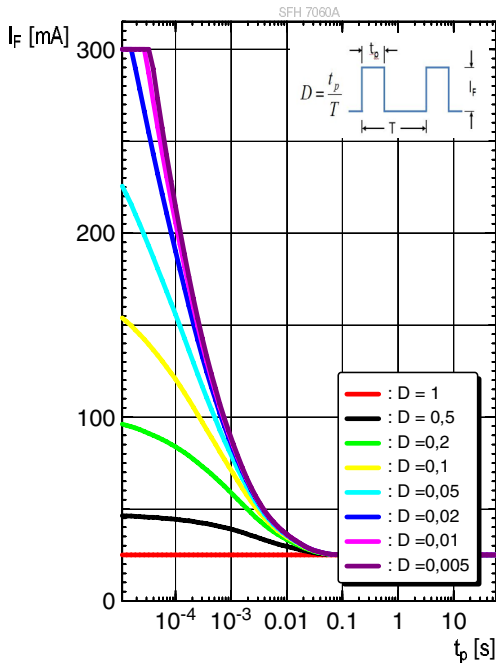

### Permissible Pulse Handling Capability

● red:  $I_F = f(t_p)$ ;  $D =$  parameter;  $T_A = 85\text{ °C}$

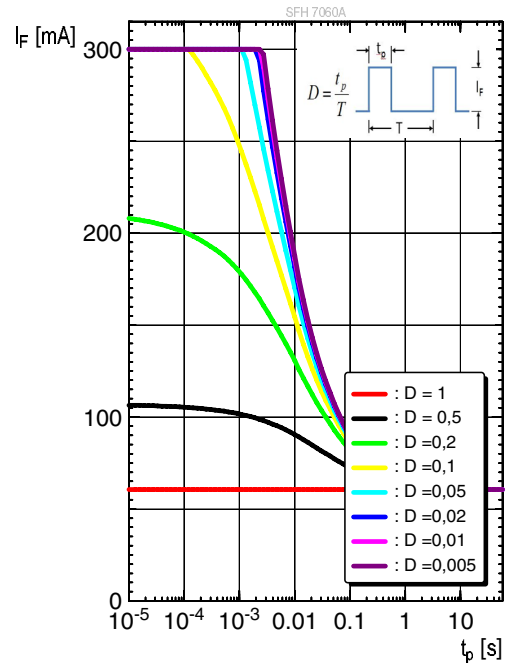

### Permissible Pulse Handling Capability

● infrared (940 nm):  $I_F = f(t_p)$ ;  $D =$  parameter;  $T_A = 85\text{ °C}$

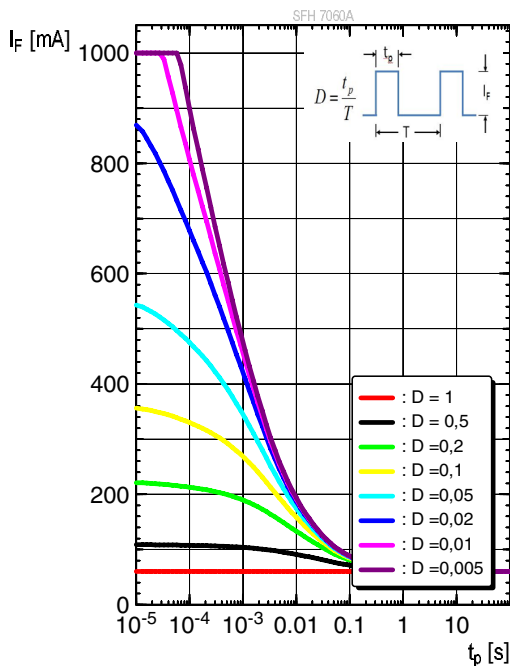

## Dimensional Drawing <sup>3)</sup>

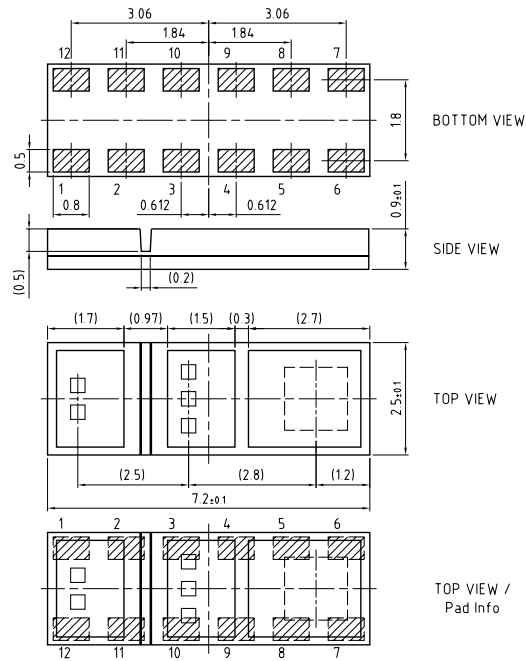

C63062-A4431-A1-01

## Further Information:

**Approximate Weight:** 28.0 mg

Recommended Solder Pad <sup>3)</sup>

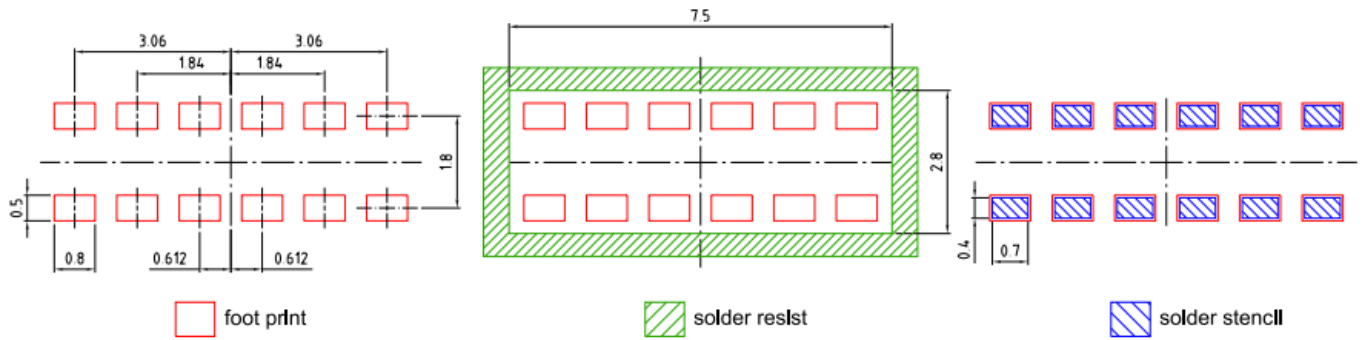

Component Location on Pad

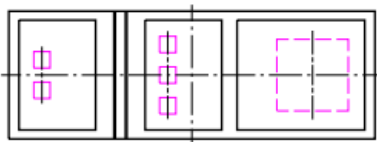

E062.3010.191-02

## Reflow Soldering Profile

Product complies to MSL Level 4 acc. to JEDEC J-STD-020E

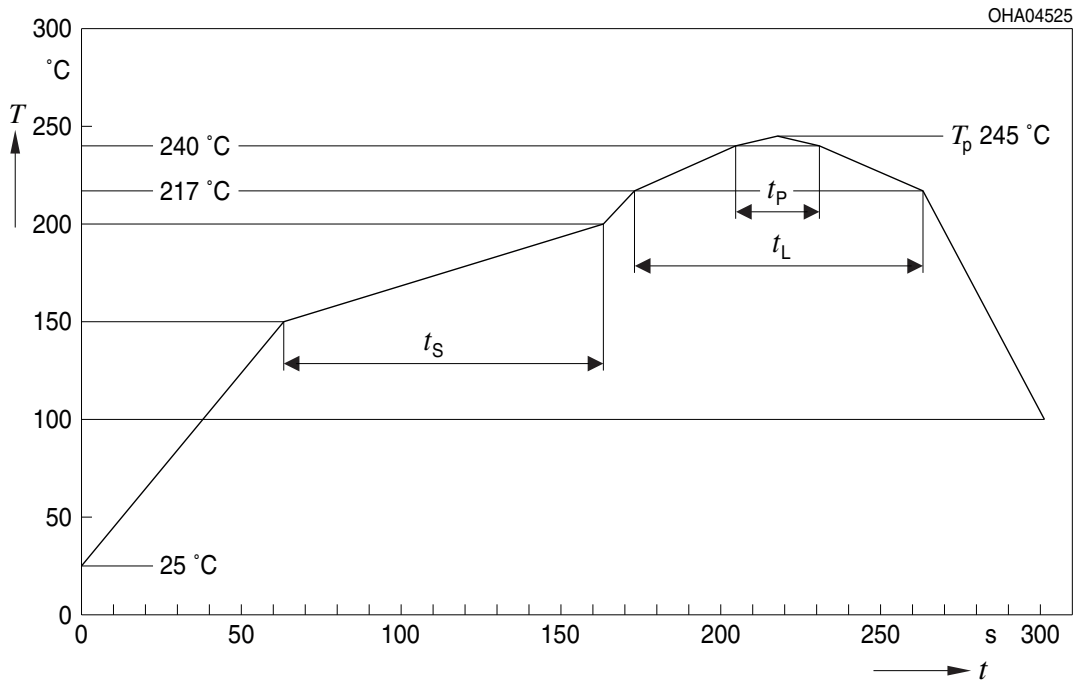

Profile Feature	Symbol	Pb-Free (SnAgCu) Assembly			Unit
		Minimum	Recommendation	Maximum	
Ramp-up rate to preheat <sup>*)</sup> 25 °C to 150 °C			2	3	K/s
Time $t_s$ $T_{Smin}$ to $T_{Smax}$	$t_s$	60	100	120	s
Ramp-up rate to peak <sup>*)</sup> $T_{Smax}$ to $T_p$			2	3	K/s
Liquidus temperature	$T_L$		217		°C
Time above liquidus temperature	$t_L$		80	100	s
Peak temperature	$T_p$		245	260	°C
Time within 5 °C of the specified peak temperature $T_p - 5$ K	$t_p$	10	20	30	s
Ramp-down rate* $T_p$ to 100 °C			3	6	K/s
Time 25 °C to $T_p$				480	s

All temperatures refer to the center of the package, measured on the top of the component

\* slope calculation  $DT/Dt$ :  $Dt$  max. 5 s; fulfillment for the whole T-range

Taping <sup>3)</sup>

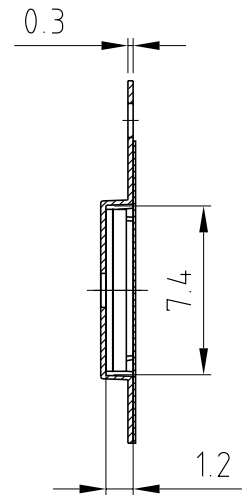
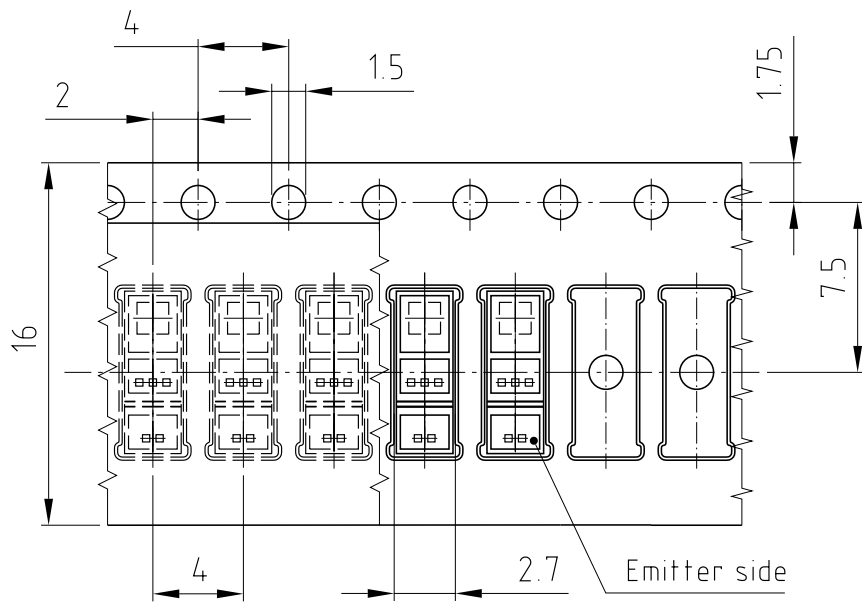

C63062-A4289-B6 -02

## Tape and Reel <sup>4)</sup>

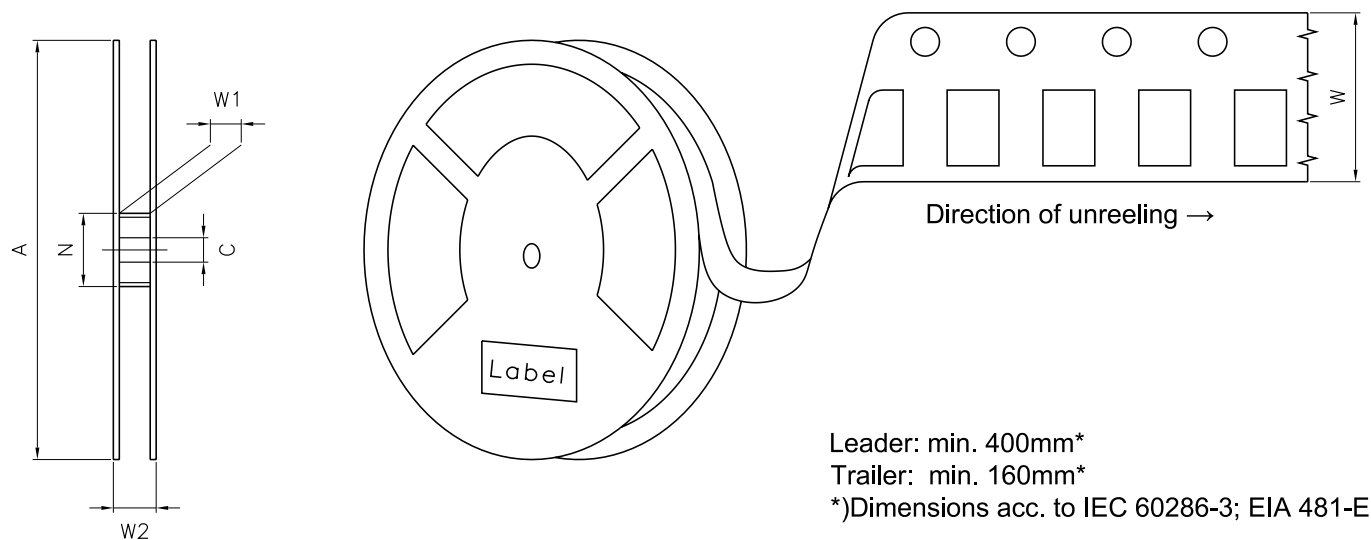

### Reel Dimensions

A	W	N <sub>min</sub>	W <sub>1</sub>	W <sub>2max</sub>	Pieces per PU
180 mm	16 + 0.3 / - 0.1 mm	60/100 mm	16.4 + 2 mm	22.4 mm	3000

### Barcode-Product-Label (BPL)

**OSRAM** LX XXXX BIN1: XX-XX-X-XXX-X

RoHS Compliant

(6P) BATCH NO: 1234567890

(1T) LOT NO: 1234567890 (9D) D/C: 1234

(X) PROD NO: 123456789 (Q) QTY: 9999 (G) GROUP: XX-XX-X-X

ML Temp ST  
X XXX °C X

Pack: RXX  
DEMY XXX  
X\_X123\_1234.1234 X

OHA04563

### Dry Packing Process and Materials <sup>3)</sup>

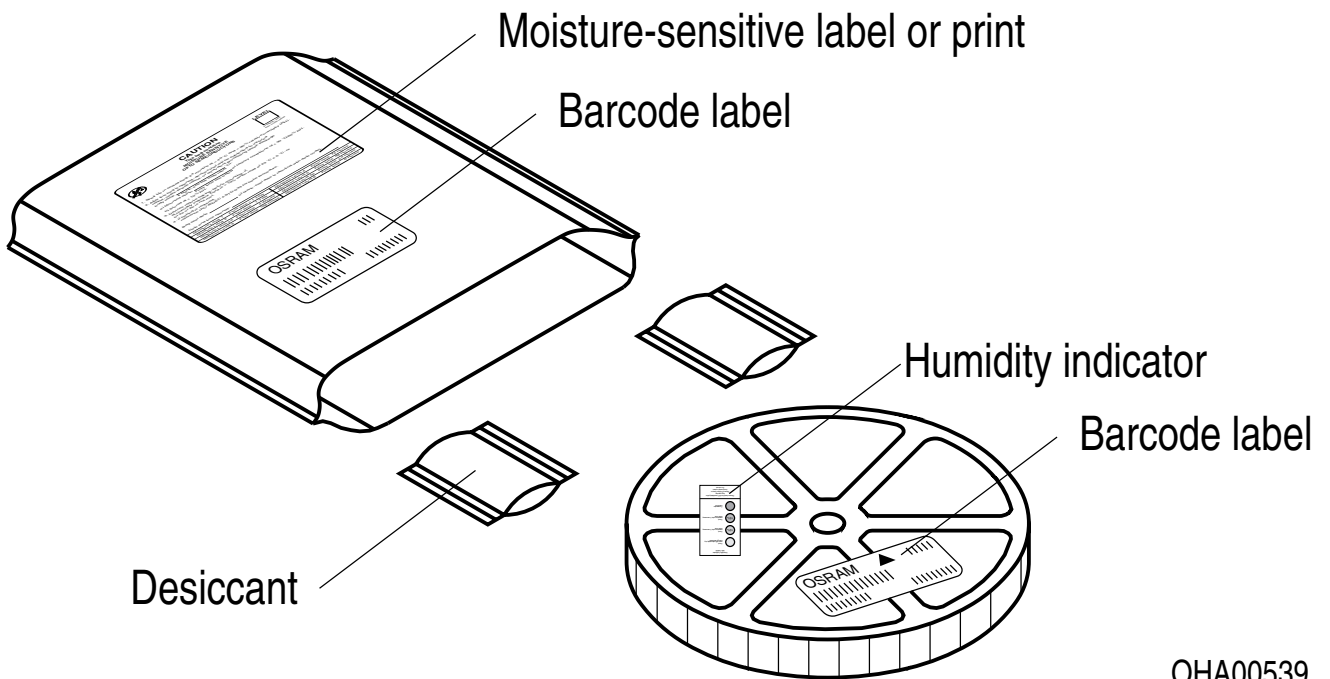

OHA00539



## Disclaimer

### Attention please!

The information describes the type of component and shall not be considered as assured characteristics. Terms of delivery and rights to change design reserved. Due to technical requirements components may contain dangerous substances.

For information on the types in question please contact our Sales Organization.

If printed or downloaded, please find the latest version on our website.

### Packing

Please use the recycling operators known to you. We can also help you – get in touch with your nearest sales office. By agreement we will take packing material back, if it is sorted. You must bear the costs of transport. For packing material that is returned to us unsorted or which we are not obliged to accept, we shall have to invoice you for any costs incurred.

### Product and functional safety devices/applications or medical devices/applications

Our components are not developed, constructed or tested for the application as safety relevant component or for the application in medical devices.

Our products are not qualified at module and system level for such application.

In case buyer – or customer supplied by buyer – considers using our components in product safety devices/ applications or medical devices/applications, buyer and/or customer has to inform our local sales partner immediately and we and buyer and /or customer will analyze and coordinate the customer-specific request between us and buyer and/or customer.

---

## Glossary

- 1) **Typical Values:** Due to the special conditions of the manufacturing processes of semiconductor devices, the typical data or calculated correlations of technical parameters can only reflect statistical figures. These do not necessarily correspond to the actual parameters of each single product, which could differ from the typical data and calculated correlations or the typical characteristic line. If requested, e.g. because of technical improvements, these typ. data will be changed without any further notice.
- 2) **Testing temperature:**  $T_A = 25^\circ\text{C}$  (unless otherwise specified)
- 3) **Tolerance of Measure:** Unless otherwise noted in drawing, tolerances are specified with  $\pm 0.1$  and dimensions are specified in mm.
- 4) **Tape and Reel:** All dimensions and tolerances are specified acc. IEC 60286-3 and specified in mm.
- 5) **Reverse Operation:** This product is intended to be operated applying a forward current within the specified range. Applying any continuous reverse bias or forward bias below the voltage range of light emission shall be avoided because it may cause migration which can change the electro-optical characteristics or damage the LED.
- 6) **Wavelength:** The wavelengths are measured with a tolerance of  $\pm 1$  nm.
- 7) **Brightness:** The brightness values are measured with a tolerance of  $\pm 11\%$ .
- 8) **Forward Voltage:** The forward voltages are measured with a tolerance of  $\pm 0.1$  V.

---

## Revision History

Version	Date	Change
1.0	2022-01-27	Initial Version
1.1	2022-08-01	Initial Version
1.1	2024-02-22	Initial Version



EU RoHS and China RoHS compliant product

此产品符合欧盟 RoHS 指令的要求；  
按照中国的相关法规和标准，  
不含有毒有害物质或元素。

**Published by ams-OSRAM AG**

Tobelbader Strasse 30, 8141 Premstaetten, Austria

Phone +43 3136 500-0

[ams-osram.com](http://ams-osram.com)

© All rights reserved

**am** 

**OSRAM**

## X-ON Electronics

Largest Supplier of Electrical and Electronic Components

*Click to view similar products for [Biometric Sensors](#) category:*

*Click to view products by [Osram](#) manufacturer:*

Other Similar products are found below :

[NPC-120T](#) [BH1792GLC-E2](#) [SFH 7070](#) [AFE4410YZT](#) [20-0584](#) [20-0599](#) [20-0696](#) [NPC-100T](#) [AS7026GG](#) [AS7026GG-COLM](#) [AS7038GB-COLM](#) [ZF-BP3-SH](#) [MAX30101EFD+T](#) [MAX30102EFD+T](#) [MAX86141ENP+T](#) [B5T-001001\(G\)](#) [B5T-007001-010](#) [B5T-007001-020](#)  
[MAX30034CUA+](#) [SFH 7050A](#) [SFH 7074](#) [XB5S6B2M12](#) [SFH 7072](#) [SEN-12969](#) [10184000-01](#)