

## FRICION HOLD ACTUATION STYLE THUMBWHEEL

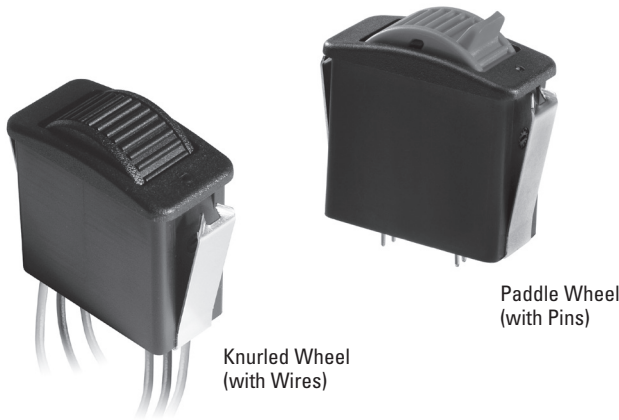

Knurled Wheel  
(with Wires)

Paddle Wheel  
(with Pins)

The HTWF Friction Hold Thumbwheel offers a maintained position, single axis thumbwheel actuator that provides a linear change in voltage output in either direction from center. Options include increasing or decreasing voltage output from the center position to the full travel position, and single or dual (redundant) outputs per axis. The HTWF Thumbwheel has a rocker style snap-in mounting feature to accommodate a 1.47" x 0.710" panel opening. The HTWF provides 250,000 cycle life, full forward/full backward, electronics are sealed to IP68S, and offers excellent EMI/RFI immunity and a flow through design. Ideal for heavy equipment, industrial machines or remote control applications.

### Features:

- 250,000 cycle life, full forward/full backward with center detent
- Maintained control positioning, no return to center
- Hall effect contactless sensing technology
- Number of output options
- Choice of bezel & button colors
- Snaps into 1.47" x 0.710" panel opening
- Electronics sealed to IP68S
- Excellent EMI/RFI immunity
- RoHS compliant

Standard Characteristics/Ratings:				
<b>MECHANICAL:</b>				
<b>Mechanical Life:</b> 250,000 full forward to full back with center detent				
<b>Initial Operating Force at Top of Roller:</b> 2 oz min to 6 oz max @ 25°C				
<b>Max Allowable Radial Load:</b> 30.0 lbs.				
<b>ELECTRICAL RATINGS: Rated at Vcc = 5V @ 25°C Load = 1mA (4.7KΩ)</b>				
Electrical	Units	Min	Typ	Max
Supply Voltage	VDC	4.5	5	5.5
Output Voltage Tolerance at Center <i>(see graph for output values)</i>	VDC @ 5V Vcc	-0.15	N/A	+0.15
Output Voltage Tolerance Full Travel <i>(see graph for output values)</i>	VDC @ 5V Vcc	-0.25	N/A	+0.25
Supply Current Per Sensor	mA	N/A	N/A	10
<b>ELECTRONICS:</b>				
<b>Seal Integrity:</b> Electronics watertight per IP68S, 1 meter				
<b>ENVIRONMENTAL:</b>				
<b>Operating Temp Range:</b> -40°C to +85°C				
<b>Humidity:</b> 96% RH, 70°C, 96 hours				
<b>Vibration:</b> Per MIL-810F minimum integrity				
<b>EMI:</b> Withstand per SAE J1113				
<b>RFI:</b> Withstand per SAE J1113				
<b>MATERIALS:</b>				
<b>Button:</b> Thermoplastic				
<b>Bezel:</b> Thermoplastic				
<b>Snap Arms:</b> Stainless steel				
<b>Wires:</b> 18 AWG				

### HTWF PART NUMBER CODE

HTWF	-	X	X	X	X	X	X	X
Travel	Output 1	Output 2	Operating Force	Button Style	Termination	Bezel Color	Button Color	Detent (if required)
1. +/- 30°	A. 2.5 +/- 2.0VDC	NONE	1. 4.0 oz.	1. Knurled Wheel	A. 18 AWG Wires, 18.3" Long, Stripped Ends	1. Red	1. Red	A. Detent 2 oz increase out of center in both directions*
	B. 2.5 +/- 2.0VDC	2.5 +/- 2.0VDC		2. Paddle Wheel	B. 0.025" SQ. Pins	2. Black	2. Black	
	C. 2.5 +/- 2.0VDC	2.5 +/- 2.0VDC				3. Orange	3. Orange	
	D. 2.5 +/- 1.5VDC	NONE				4. Yellow	4. Yellow	
	E. 2.5 +/- 1.5VDC	2.5 +/- 1.5VDC				5. Green	5. Green	
	F. 2.5 +/- 1.5VDC	2.5 +/- 1.5VDC				6. Blue	6. Blue	
	G. 1.0 - 4.0VDC	1.0 - 4.0VDC				7. Violet	7. Violet	
	H. 0.5 - 4.5VDC	0.5 - 4.5VDC				8. Gray	8. Gray	
						9. White	9. White	

\* Output options A-F do not have a tolerance on the center outputs unless a center detent is selected. Output options G and H are only available with center detent.

# PROPORTIONAL OUTPUT THUMBWHEEL

**HTWF**  
HALL EFFECT  
THUMBWHEEL

FRICION HOLD ACTUATION STYLE THUMBWHEEL

## HTWF - Paddle Wheel Style Thumbwheel Shown

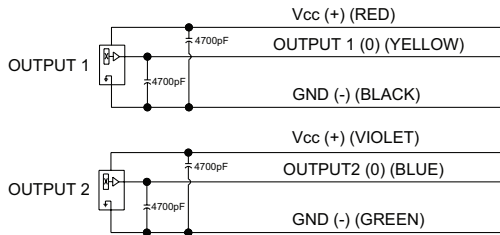
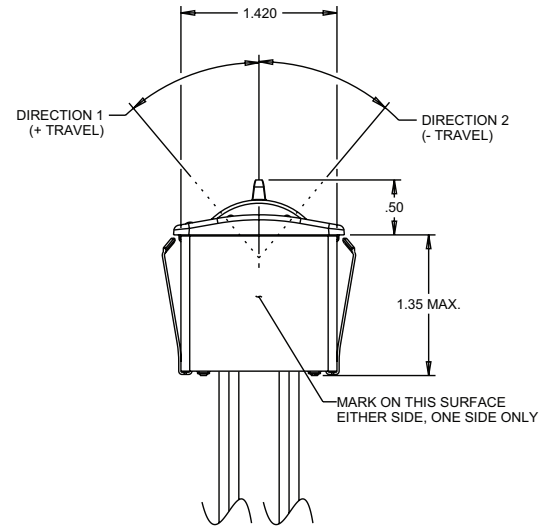
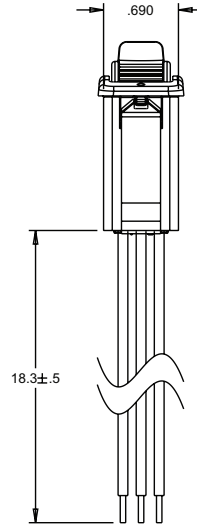
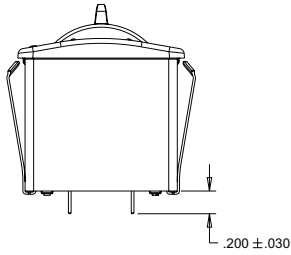
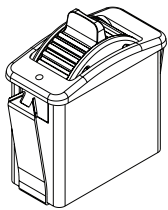

OUTPUT 2 IS NOT PRESENT IN ALL CONFIGURATIONS

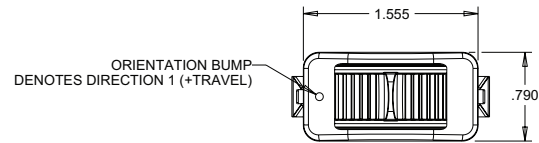

### MOUNTING:

RECOMMENDED PANEL THICKNESS: 0.100 OPTIMUM THICKNESS  
(0.050 MIN. - 0.120 MAX.)

RECOMMENDED PANEL OPENING: 0.710 X 1.470 OPTIMUM  
(0.710/0.720 - 1.460/1.480)

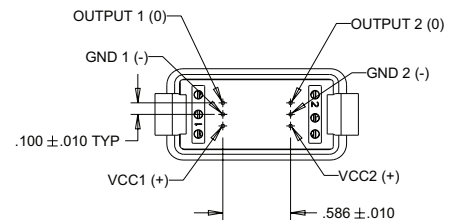
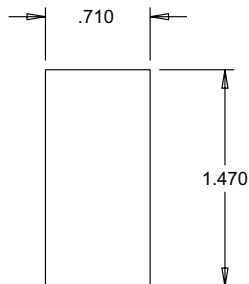

**PINNED  
TERMINATION**  
NOT ALL PINS ARE PRESENT  
IN ALL OUTPUT CONFIGURATIONS

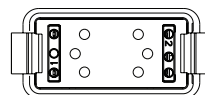

NOT ALL WIRES ARE PRESENT  
IN ALL OUTPUT CONFIGURATIONS

HALL EFFECT CONTROLS

## FRICION HOLD ACTUATION STYLE THUMBWHEEL

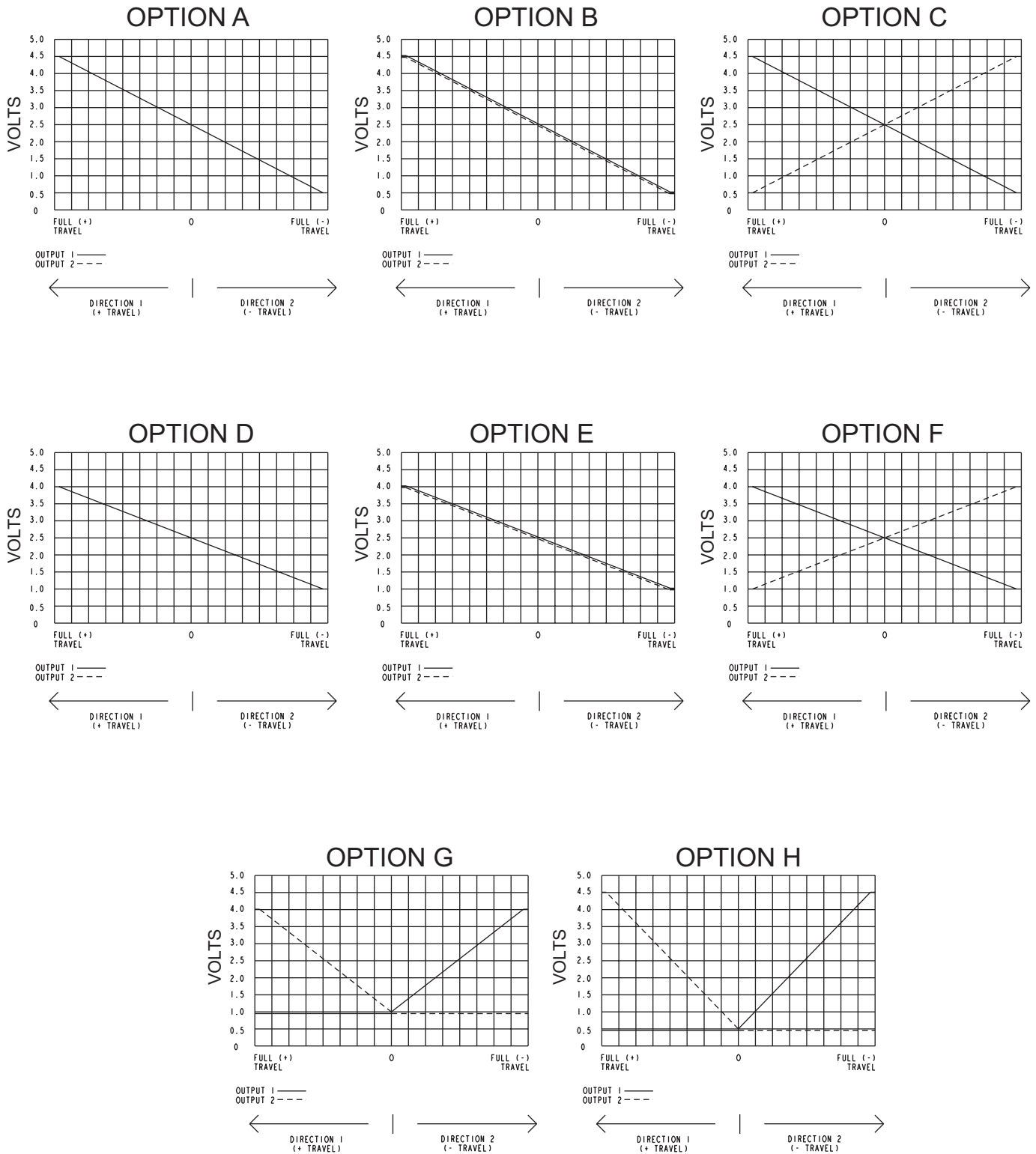

## X-ON Electronics

Largest Supplier of Electrical and Electronic Components

*Click to view similar products for [Thumbwheel Switches & Pushwheel Switches](#) category:*

*Click to view products by [OTTO](#) manufacturer:*

Other Similar products are found below :

[PICOD131ALULS2](#) [A7SS-107-PM](#) [DGAN-031-B](#) [1437603-2](#) [DPS10131AL2](#) [DPS10301AK](#) [DPS8111AK](#) [DPS8137AK2](#) [1437603-7](#) [A7M-1P](#) [B5LS](#) [B5LS](#) [3-1437603-8](#) [DGBN-036-B](#) [DPS10131AK](#) [DPS910A2](#) [1-1437602-8](#) [SH6G137AKLS2](#) [1-1437603-1](#) [SMCL2](#)  
[SMCD137AK](#) [SP1.5](#) [DPS8111AK2](#) [TW01RED14](#) [TW01BLK14](#) [84212014](#) [84212013](#) [HTWF-1A12A21](#) [301419100](#) [302109002](#)  
[302329N00](#) [311100001](#) [312100100](#) [312300000](#) [332300003](#) [337100000](#) [342300001](#) [311100000](#) [312100000](#) [313100000](#) [313110003](#)  
[321400100](#) [322300000](#) [323100000](#) [332100100](#) [333100110](#) [347100000](#) [301119000](#) [303109101](#) [332710P00](#)