

RETURN TO END MINI THUMBWHEEL

HTWME
MINIATURE
THUMBWHEEL

PROPORTIONAL OUTPUT HALL EFFECT MINI THUMBWHEEL



Knurled Wheel



Paddle Wheel

The HTWME offers the same performance as the standard HTWE single axis, proportional output thumbwheel, but has a much shorter behind panel depth. With a panel depth of 0.96" max., the HTWME is ideal for panel or armrest mountings, or can be incorporated into one of OTTO's joysticks. The HTWME provides snap-in style mounting, and also utilizes non-contact Hall effect technology, which accounts for a one million cycle life. It also has excellent EMI/RFI shielding per MIL-STD-461D/SAE J1113-22 and RFI to withstand 100 V/M, 14Hz to 1GHz. Configuration options include a choice of six linear voltage outputs.

Features:

- Return to end single axis actuator
- Shorter behind panel depth: 0.96"
- Knurled & Paddle style actuators
- Wire or pinned termination options
- Variety of button & bezel colors
- 6 output options
- Easy snap-in mounting
- 1 million cycle rotational life
- Electronics sealed to IP68S
- Excellent EMI/RFI immunity
- RoHS/WEEE/Reach compliant

Standard Characteristics/Ratings:				
MECHANICAL:				
Mechanical Life: 1,000,000 full forward to full back				
Max Allowable Radial Load: 30.0 lbs.				
ELECTRICAL RATINGS: Rated at 5V @ 25°C Load = 1mA (4.7KΩ)				
Electrical	Units	Min	Typ	Max
Supply Voltage	VDC	4.5	5.0	5.5
Output at Rest	VDC @ 5V Vcc	-25	N/A	+25
Output at Full Travel	VDC @ 5V Vcc	-25	N/A	+25
Supply Current Per Sensor	mA	N/A	N/A	10
ELECTRONICS:				
Seal Integrity:	Electronics IP68S			
ENVIRONMENTAL:				
Operating Temp Range:	-40°C to +85°C			
Humidity:	96% RH, 70°C, 96 hours			
Vibration:	Per MIL-810F minimum integrity			
Sand/Dust:	Per SAE J1455			
EMI:	Withstand per MIL-STD-461D/SAE J1113-22			
RFI:	Withstand 100V/M 14Hz to 1GHz			
MATERIALS:				
Button:	Thermoplastic			
Bezel:	Thermoplastic			
Snap Arms:	Thermoplastic			
Wires:	18 AWG			

HTWME RETURN TO END THUMBWHEEL MINIATURE CASE

HTWME	X	X*	X	X	X	X	X
Travel	Output 1	Output 2	Operating Force	Button Style	Termination	Bezel Color	Button Color
1. 80°	A. 0.5 - 4.5VDC	NONE	1. 10 oz typ	1. Knurled Wheel	A. 18 AWG Wire, 18.3" Long, Stripped and Tinned Ends	1. Red	1. Red
	B. 0.5 - 4.5VDC	0.5 - 4.5VDC		2. Paddle Wheel	B. 0.025" SQ. Pins	2. Black	2. Black
	C. 0.5 - 4.5VDC	4.5 - 0.5VDC				3. Orange	3. Orange
	D. 1.0 - 4.0VDC	NONE				4. Yellow	4. Yellow
	E. 1.0 - 4.0VDC	1.0 - 4.0VDC				5. Green	5. Green
	F. 1.0 - 4.0VDC	4.0 - 1.0VDC				6. Blue	6. Blue
						7. Violet	7. Violet
						8. Gray	8. Gray
						9. White	9. White

* Output options B and E provide redundant output 2 which duplicates output 1. Output options C and F provide redundant output 2 which is inverse output 1.

SHORTER BEHIND PANEL DEPTH

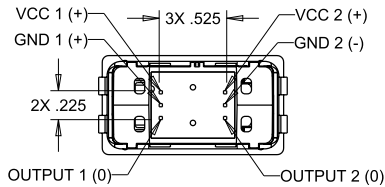
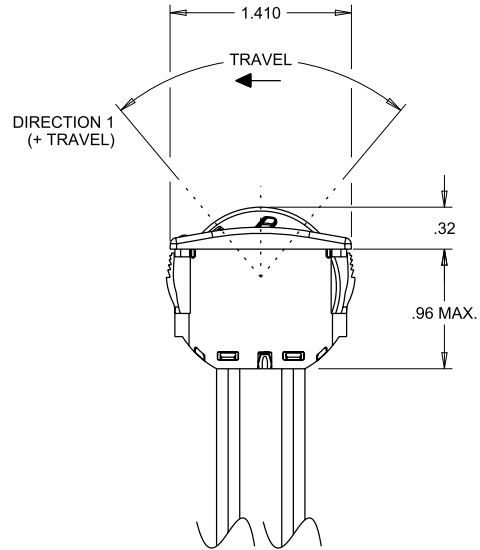
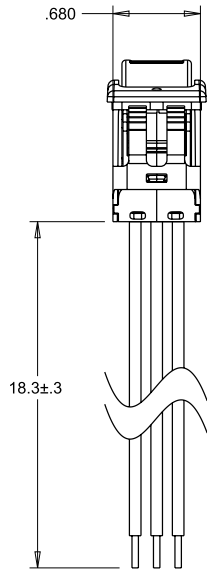
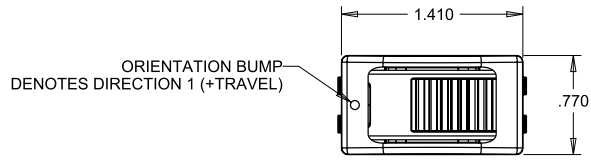
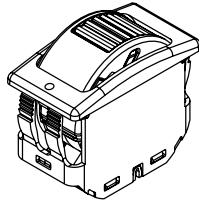

PINNED TERMINATION
NOT ALL PINS ARE PRESENT
IN ALL OUTPUT CONFIGURATIONS

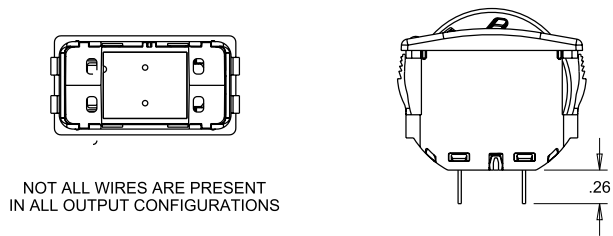

MOUNTING:

RECOMMENDED PANEL THICKNESS: 0.150 OPTIMUM THICKNESS
(0.040 MIN. - 0.200 MAX.)

RECOMMENDED PANEL OPENING: 0.700 X 1.340 OPTIMUM
(0.695/0.705 X 1.335/1.345)

RECOMMENDED PANEL RADII: 0.100 OPTIMUM
(0.090 - 0.110 MAX.)

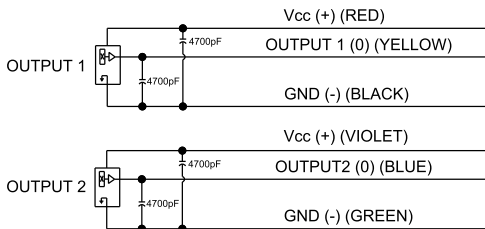

OUTPUT 2 IS NOT PRESENT IN ALL CONFIGURATIONS

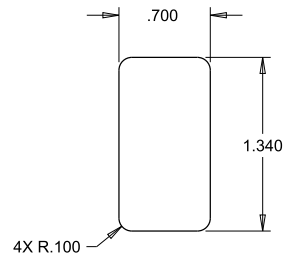

RETURN TO END MINI THUMBWHEEL

SHORTER BEHIND PANEL DEPTH

OPTION A

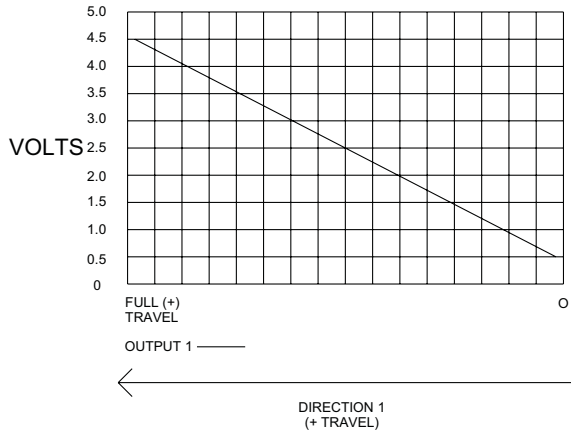

OPTION B

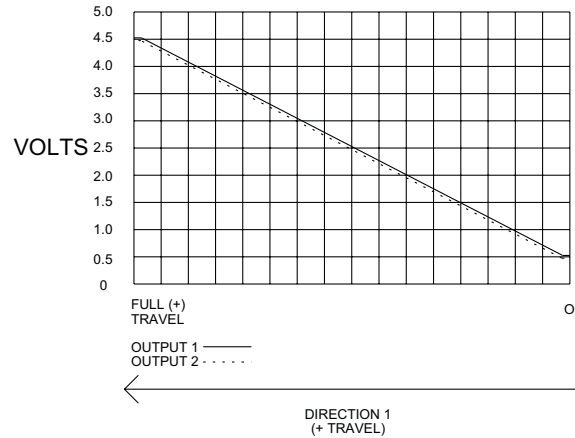

OPTION C

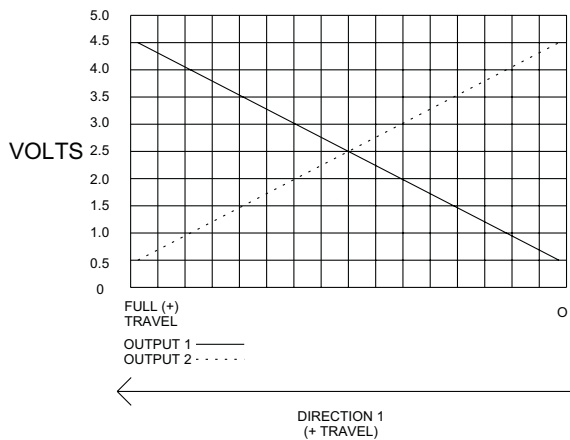

OPTION D

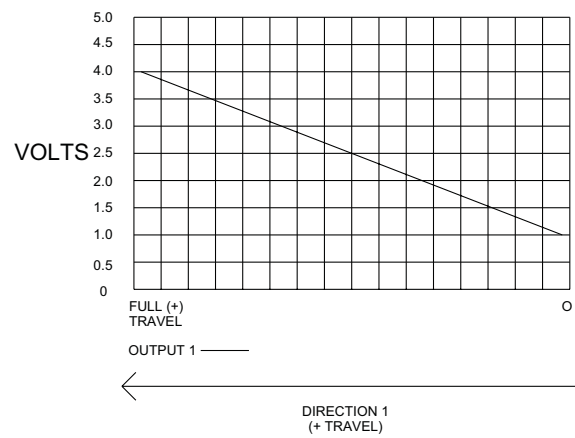

OPTION E

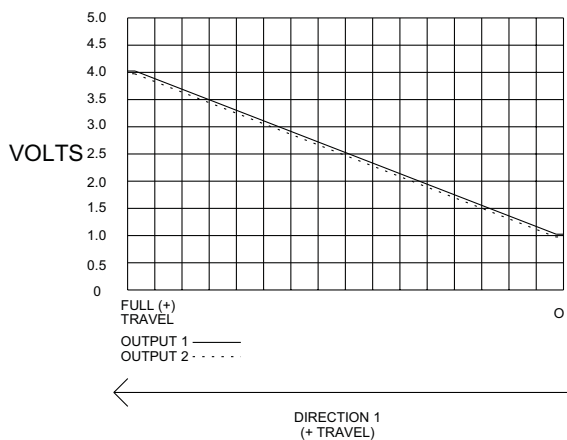

OPTION F

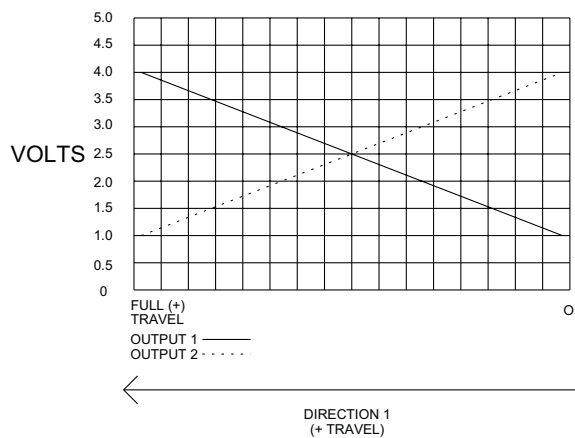

HALL EFFECT

X-ON Electronics

Largest Supplier of Electrical and Electronic Components

Click to view similar products for [Thumbwheel Switches & Pushwheel Switches](#) category:

Click to view products by [OTTO](#) manufacturer:

Other Similar products are found below :

[PICOD131ALULS2](#) [A7SS-107-PM](#) [DGAN-031-B](#) [1437603-2](#) [DPS10131AL2](#) [DPS10301AK](#) [DPS8111AK](#) [DPS8137AK2](#) [1437603-7](#) [A7M-1P](#) [B5LS](#) [B5LS](#) [3-1437603-8](#) [DGBN-036-B](#) [DPS10131AK](#) [DPS910A2](#) [1-1437602-8](#) [SH6G137AKLS2](#) [1-1437603-1](#) [SMCL2](#)
[SMCD137AK](#) [SP1.5](#) [DPS8111AK2](#) [TW01RED14](#) [TW01BLK14](#) [84212014](#) [84212013](#) [HTWF-1A12A21](#) [301419100](#) [302109002](#)
[302329N00](#) [311100001](#) [312100100](#) [312300000](#) [332300003](#) [337100000](#) [342300001](#) [311100000](#) [312100000](#) [313100000](#) [313110003](#)
[321400100](#) [322300000](#) [323100000](#) [332100100](#) [333100110](#) [347100000](#) [301119000](#) [303109101](#) [332710P00](#)