

SEALED, ILLUMINATED ROCKER SWITCHES

K1/K2
SNAP-IN
ROCKERS

LOW COST, SNAP-IN ROCKER FOR WET & DUSTY ENVIRONMENTS

The K series rockers are rugged, high performance sealed switches designed for use under severe conditions found in marine, appliance, heavy equipment and industrial control applications. Sealed to IP68S with an optional panel gasket available.

The K1 series is offered in single pole configuration while the K2 series is available in single and double pole configurations. Both series offer illuminated models. Illumination can be independent or dependent of the switch position or a combination of both. A choice of red, green, clear or amber colored lenses are offered in illuminated models. Illumination options include incandescent, LED or neon light sources.

Mounting is simple and quick; snaps into panel from the front. The OTTO snap-in design supports a variety of panel thicknesses with just one cutout size specified.

A choice of models are offered to handle power levels to 16 amps, 1/2 HP and low level electronic switching applications.

OTTO can provide custom colors upon request. Value-added assemblies with wire leads are also available. Please consult the factory for assistance.



K1 Series
Single Pole

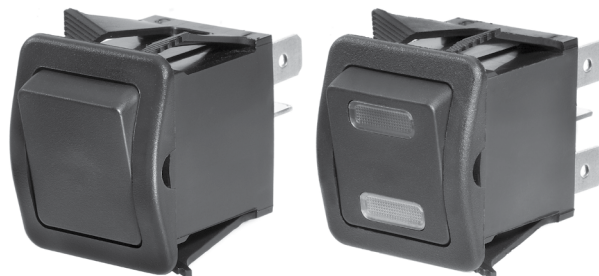

K2 Series
Single & Double Pole



Features:

- Withstands direct water spray
- Watertight to IP68S
- Fits industry standard panel openings for drop-in replacement of panel sealed & unsealed switches
- Snap-in feature accommodates a wide range of panel cutouts
- Switches up to 16 amps
- UV & solvent resistant
- Withstands extreme shock & vibration
- Custom legends available
- 2 & 3-position, momentary & maintained action
- Incandescent, LED & neon illumination with independent & dependent light source options
- UL recognized & CSA certified
- Ignition protected
- RoHS/WEEE/Reach compliant

Standard Characteristics/Ratings:

ELECTRICAL RATINGS:

Load	Sea Level @ 28VDC or 125/250VAC, 60Hz	Cycles
Resistive	16A	25,000
Resistive	10A	50,000
Inductive	10A	25,000
Lamp	5A	25,000
Motor	0.5HP	25,000
DWV	1050Vrms except across light terminals	
Low Level	10mA @ 30mV	

Electrical Life: See Rating Chart

LIGHTING:

Light Source	Rating
Incandescent	(VDC) 6V, 12V, 24V
Neon	(VAC) 125V, 250V
LED	(VDC) 2V, 6V, 12V, 24V

Mechanical Life: 100,000 cycles

Seal: IP68S

Operating Temp Range: -30°C to +85°C

MATERIALS:

Case:	Thermoplastic
Button:	Thermoplastic
Base:	Thermoplastic
Terminals/Contact:	Brass, silver alloy with silver plate, gold flash for low level
Terminal Hardware:	Screws and lockwashers provided when applicable K1/K2 series recommended Quick Connect terminals: AMP 60253-2 for 12-16 AWG AMP 42100-2 for 14-18 AWG
Mounting Hardware:	None provided

LOW COST, SNAP-IN ROCKER FOR WET & DUSTY ENVIRONMENTS, 1 & 2 POLES

K2 PART NUMBER CODE

Part Number Code Continued Below

K2 X

Terminal Style/ Switch Rating

- A. Quick Connect/Standard
- B. Screw/Standard
- C. Solder/Standard
- D. Quick Connect/Low Level
- E. Screw/Low Level
- F. Solder/Low Level

X

Actuator Color/Style

- A. Red Standard
- B. Black Standard
- C. White Standard
- D. Red Standard Paddle
- E. Black Standard Paddle
- F. White Standard Paddle
- G. Red Short Paddle Pinned
- H. Black Short Paddle Pinned
- J. White Short Paddle Pinned
- K. Red Standard Paddle Pinned
- L. Black Standard Paddle Pinned
- M. White Standard Paddle Pinned
- N. Red Standard Pinned
- P. Black Standard Pinned
- R. White Standard Pinned

NOTE: For custom colors, contact factory.

X

Switch Action/Circuit

	Position "A"	Position "B"	Position "C"	Circuit
A.	1-C1	NONE	OFF	SPST
B.	1-C1	NONE	2-C1	SPDT
C.	(1-C1)	NONE	OFF	SPST
D.	(1-C1)	NONE	2-C1	SPDT
E.	(1-C1)	OFF	(2-C1)	SPDT
F.	1-C1	OFF	2-C1	SPDT
G.	(1-C1)	OFF	2-C1	SPDT
H.	1-C1/3-C2	NONE	OFF	DPST
J.	1-C1/3-C2	NONE	2-C1/4-C2	DPDT
K.	(1-C1)/(3-C2)	NONE	OFF	DPST
L.	(1-C1)/(3-C2)	NONE	2-C1/4-C2	DPDT
M.	(1-C1)/(3-C2)	OFF	(2-C1)/(4-C2)	DPDT
N.	1-C1/3-C2	OFF	2-C1/4-C2	DPDT
P.	(1-C1)/(3-C2)	OFF	2-C1/4-C2	DPDT
Q.	1-C1	NONE	(2-C1)	SPDT
R.	OFF	NONE	(2-C1)	SPST
S.	1-C1/3-C2	NONE	(2-C1)/(4-C2)	DPDT
T.	OFF	NONE	(2-C1)/(4-C2)	DPST
U.	1-C1	OFF	(2-C1)	SPDT
V.	1-C1/3-C2	OFF	(2-C1)/(4-C2)	DPDT

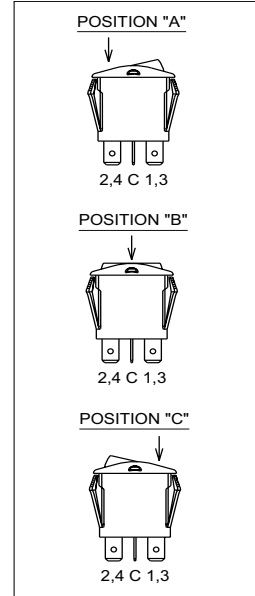

NOTE: () denotes momentary action.

K2 PART NUMBER CODE - CONTINUED FROM ABOVE

X

Light Type

- A. No Light
- B. 6V Incandescent
- C. 12V Incandescent
- D. 24V Incandescent
- E. 125 VAC Neon
- F. 250 VAC Neon
- G. 2V Red LED
- H. 2V Green LED
- J. 2V Amber LED
- K. 6V Red LED
- L. 6V Green LED
- M. 6V Amber LED
- N. 12V Red LED
- P. 12V Green LED
- Q. 12V Amber LED
- R. 24V Red LED
- S. 24V Green LED
- T. 24V Amber LED

NOTES:

- No momentary switches with dependent lights.
- Neon lamps only to be coded with clear or amber lenses.
- LED lenses must be clear or same color as LED.
- K2 connector P/N C801765.
- Recommended Quick Connect Terminals:
AMP 60253-2 for 12-16 AWG wire with 0.160" -0.210" insulation OD
AMP 42100-2 for 14-18 AWG wire with 0.100" -0.170" insulation OD
- No dependent light in OFF position.
- All legends printed on actuators without lens(es) will be white except actuator codes C, F, J, M & R.
- All legends printed on lenses will be white except on clear lens(es) will be black.
- **K2 panel plugs available as shown on page 167.**

X

Lens Color

- | Position "A" | Position "C" |
|--------------|--------------|
| A. No Lens | A. No Lens |
| B. Red | B. Red |
| C. Green | C. Green |
| D. Amber | D. Amber |
| E. Clear | E. Clear |

X

Light/Circuit Location

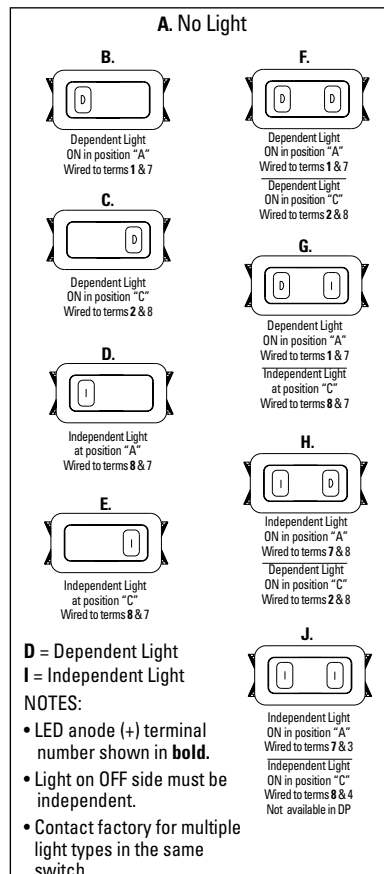

D = Dependent Light
I = Independent Light

NOTES:

- LED anode (+) terminal number shown in **bold**.
- Light on OFF side must be independent.
- Contact factory for multiple light types in the same switch.

X

Legend & Orientation

A. None

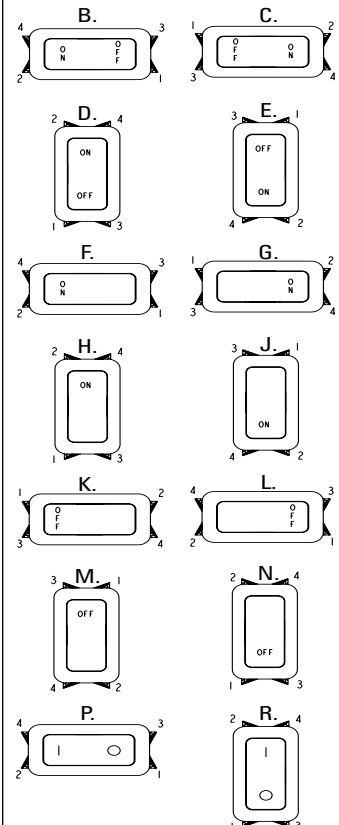

SEALED, ILLUMINATED ROCKER SWITCHES

K2
SNAP-IN
ROCKERS

LOW COST, SNAP-IN ROCKER FOR WET & DUSTY ENVIRONMENTS, 1 & 2 POLES

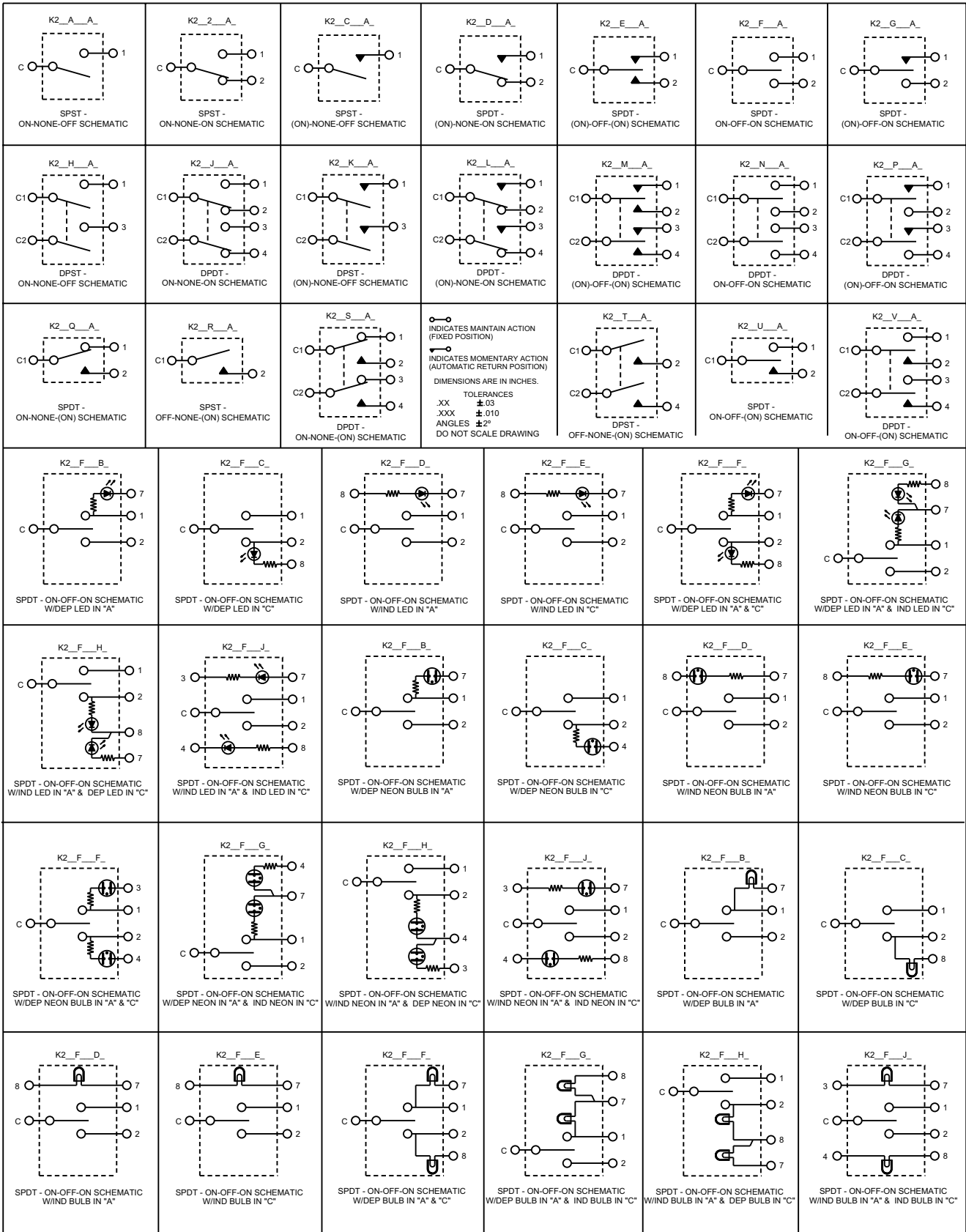

ROCKER SWITCHES

SEALED, ILLUMINATED ROCKER SWITCHES

LOW COST, SNAP-IN ROCKER FOR WET & DUSTY ENVIRONMENTS, 1 & 2 POLES

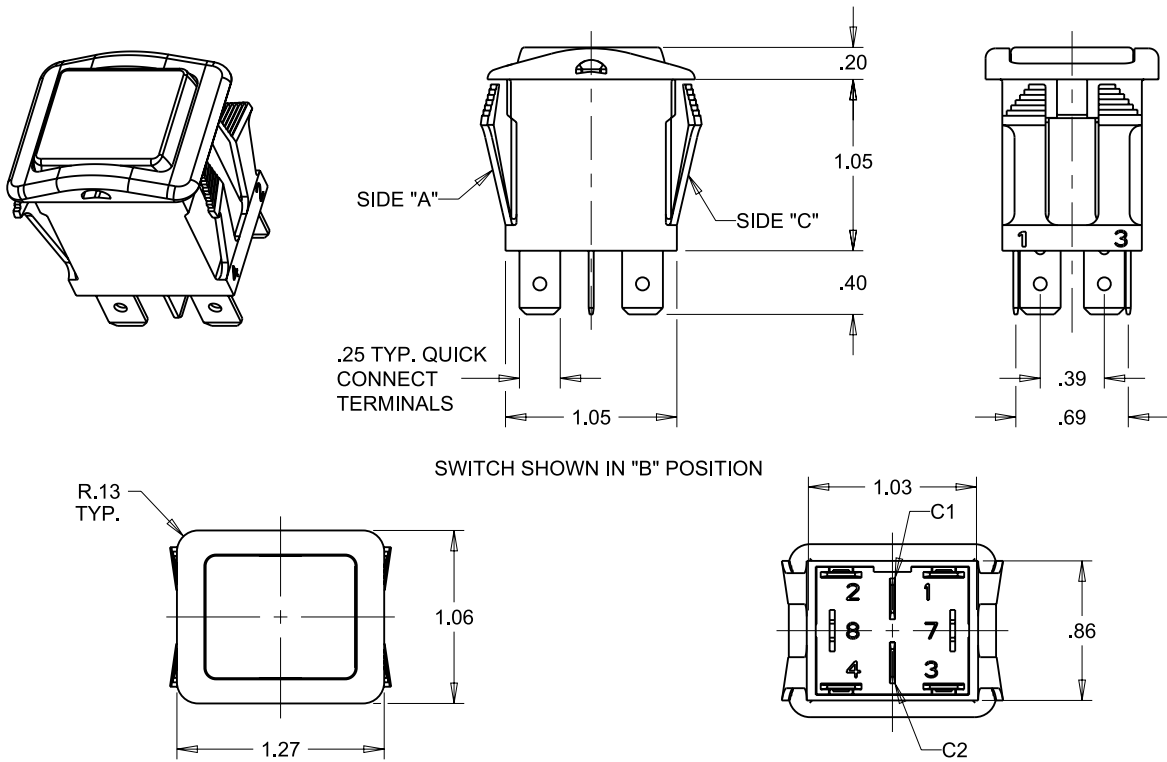

MOUNTING HOLE:

PANEL THICKNESS RANGE OF .025 - .105 A GASKET IS RECOMMENDED
 0.031" THICKNESS = GASKET P/N 807038-2
 0.062" THICKNESS = GASKET P/N 807038-1

PANEL THICKNESS RANGE OF .105 - .187 W/O GASKET

PANEL OPENING:	MIN.	TYP.	MAX.
WIDTH	.870	.937	1.000
LENGTH	1.072	1.099	1.125

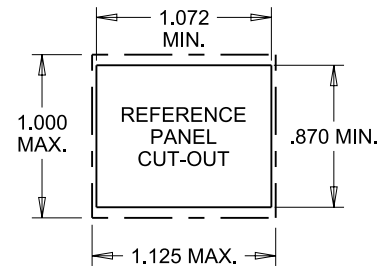

PADDLE STYLES	
SHORT PADDLE ROCKER	STANDARD PADDLE ROCKER

TERMINAL STYLES (.032 THICK)		
SCREW	QUICK CONNECT	SOLDER

X-ON Electronics

Largest Supplier of Electrical and Electronic Components

Click to view similar products for [Rocker Switches](#) category:

Click to view products by [OTTO](#) manufacturer:

Other Similar products are found below :

[LTILA6E-1S-WH-RC-FN12VXCR1](#) [6-1571986-9](#) [8007K26N324V52](#) [8055K23Z7V](#) [8055K32Z7V](#) [8055K52Z7V](#) [8138K20E6M50](#) [84206L](#)
[84312LX](#) [PREDD5-07F-BB0GW](#) [999-16716-002](#) [999-16716-003](#) [999-16716-004](#) [A101J1V3Q004](#) [A101J2ZQ004](#) [A101J4ZQ004](#)
[A101J51CB0004](#) [A103J1ZQ004](#) [A201J1AQ004](#) [A201J3ZB004](#) [A201J50ZQ004](#) [A203J51ZQ0004](#) [A435S1YZQ](#) [H8500XBBBBL-A](#)
[H8653VBBG2577W](#) [HB130CHNWWNAAC](#) [R13112ABB-602W](#) [1251.0303](#) [AE205J60V3B004](#) [1352.0107](#) [1571099-3](#) [1571987-4](#)
[1571987-5](#) [1571989-7](#) [1571988-5](#) [B123J77V7B2](#) [B226J50W4Q22P](#) [B433J37ZQ22M](#) [160212E](#) [1634200-7](#) [1801.1164](#) [1839.1502](#) [PANEL-](#)
[PLUG-VHP-BLACK](#) [PANEL-PLUG-VHP-WT](#) [K1ABBSCADN](#) [KG312A2DXD246X](#) [250011E714](#) [2600HM11E](#) [2600R21E](#) [260413E](#)