

MOMENTARY ACTION COMMERCIAL GRADE LED ILLUMINATED & SEALED

Raised Dome



Front Mount



The LP3 offers rugged, sealed construction with the added benefit of reliable LED illumination. This precision snap-action switch is designed for use in off-highway, material handling, industrial controls, marine, medical and demanding commercial applications. Choose from the standard mounting styles and electrical ratings, or contact us for custom configurations.

On sealed models, a silicone boot operating on our patented "rolling sleeve" principle protects the contact area against contamination at the button area. This boot provides long life and smooth operation over a wide temperature range. Sealed terminals protect the contact area from hostile environments and solder flux on both sealed and unsealed models.

High contact pressure and extremely low contact bounce are all the result of the OTTO snap-action mechanism. Extra long electrical life and precise trip point offer added value and precision operation.

Features:

- **Watertight to IP68S or moistureproof & dusttight to IP64**
- **LED lighted with the ability to accommodate 2, 6, 12 & 24VDC power & includes reverse voltage protection**
- **Tall & dome style buttons permitting sublimated & pad printed legends**
- **Quick disconnect terminals**
- **15/32" & 5/8" thread, press fit & dome case options**
- **RoHS compliant**

Standard Characteristics/Ratings:

ELECTRICAL RATINGS:

Load	Sea Level @ 28VDC or 115VAC, 60/400Hz
Resistive	5A
Inductive	3A
Lamp	1A
Motor	3A
DWV	1000Vrms through switch contacts only
Logic Level	10mA @ 5VDC

Electrical Life: 25,000 cycles

LIGHTING (See LED Voltage Chart in Appendix for more details):

Light Source Voltage (DC)	Typ. Forward Voltage (DC)	Voltage Max (DC)
2	1.9 to 3.3 (dep. on color)	2.5 to 4 (dep. on color)
6	6	8
12	12	14.5
24	24	28.6

Mechanical Life: 250,000 cycles @ ambient and +85°C
25,000 cycles @ -55°C

Seal: Unsealed, IP64 or IP68S

Operating Temp Range: -55°C to +85°C

Operating Force: 2.5 +/- .5 lbs. or 5.0 +/- 1.0 lb.

Total Travel: 0.080 inches max

Overtravel: 0.010 inches min

MATERIALS:

Case: Anodized aluminum alloy

Button: Thermoplastic

Terminals: Standard and logic level options available

Mounting Hardware: Hex nut and lockwasher (panel gasket for watertight switches)

LP3 PART NUMBER CODE

	LP3	-	X		X		X		X		X		X	-	XX
Case Style	Circuit Rating			Light Source Type w/ Rev. Pol Protection	Seal Level	Operating Force	Case Color	Button Color							Legend Style
E. Exposed Dome	1. SPST N.O./Std.			A. 2V Red LED*	1. Unsealed	2. 2.5 ± .5 lbs.	1. Silver	A. Amber, Translucent (use Amber LED)							Refer to Legend Table for SAE legend codes in Appendix. Legends will be printed in white on amber, red, green and blue buttons and in black on white buttons.
F. Flush Dome	2. SPST N.C./Std.			B. 2V Green LED*	2. Dusttight	5. 5.0 ± 1 lbs.	2. Black	R. Red, Translucent (use Red LED)							
R. Raised Dome	3. SPDT 2 Circuit/Std.			C. 2V Amber LED*	3. Watertight			W. White, Translucent (use Green LED)							
1. Press Fit Mount	4. SPST N.O./Logic Level			D. 6V Red LED				G. Green, Translucent (use Green LED)							
3. 5/8" Thread Front Mount	5. SPST N.C./Logic Level			E. 6V Green LED				B. Blue, Translucent (use Blue LED)							
4. 15/32" Thread Rear Mount	6. SPDT 2 Circuit/Logic Level			F. 6V Amber LED											
6. 5/8" Thread Rear Mount				G. 12V Red LED											
				H. 12V Green LED											
				J. 12V Amber LED											
				K. 24V Red LED											
				L. 24V Green LED											
				M. 24V Amber LED											
				N. 2V Blue LED*											
				P. 6V Blue LED											
				Q. 12V Blue LED											
				R. 24V Blue LED											
				S. 2V Deep Green LED*											
				T. 6V Deep Green LED											
				U. 12V Deep Green LED											
				V. 24V Deep Green LED											

STOP HERE for illuminated switches without legends.

* The "2 volt" switches are intended to have a resistor added in series into the lighting circuit by the customer. See appendix for complete voltage/ratings table.

For super bright LEDs, contact factory.

ILLUMINATED & SEALED PUSHBUTTONS

LP3
ILLUMINATED
PUSHBUTTONS

MOMENTARY ACTION COMMERCIAL GRADE LED ILLUMINATED & SEALED

LP3-EXXXXXX
Momentary, Exposed Dome Button

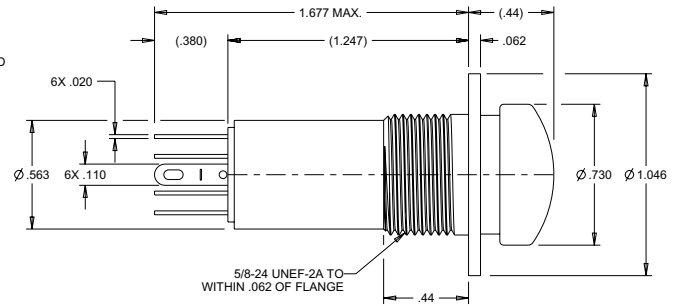
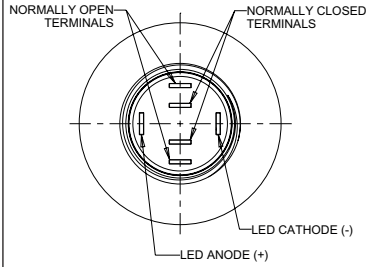
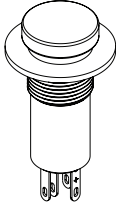

LP3-FXXXXXX
Momentary, Flush Dome Button

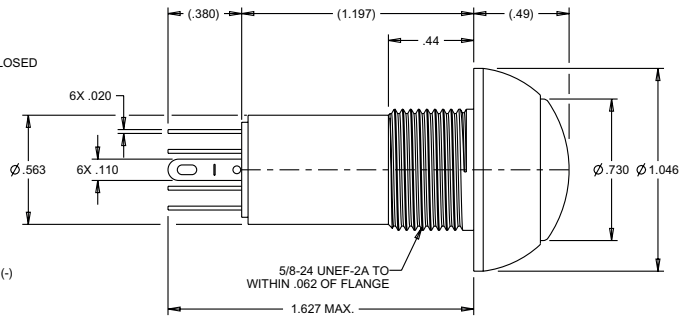
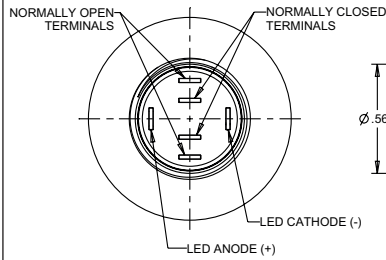
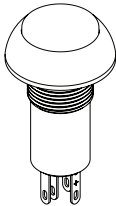

LP3-RXXXXXX
Momentary, Raised Dome Button

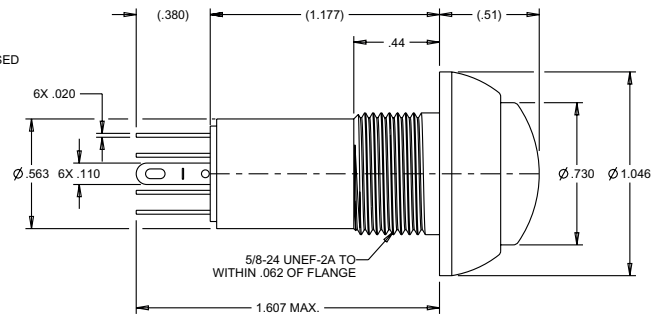
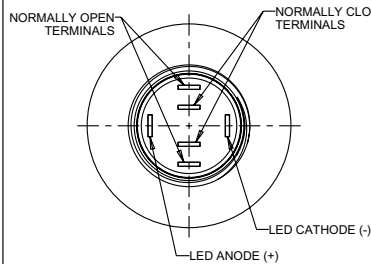
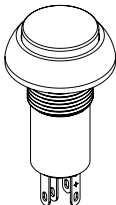

LP3-1XXXXXX
Momentary, Press Fit Mount

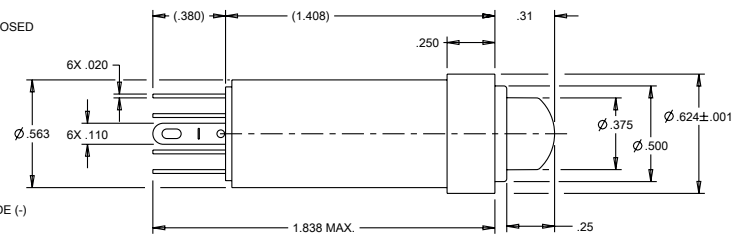
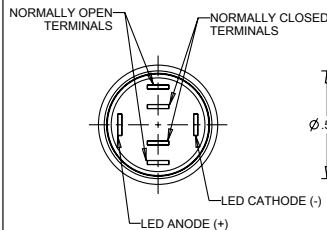
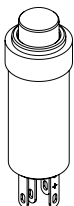

MOMENTARY ACTION COMMERCIAL GRADE LED ILLUMINATED & SEALED

LP3-3XXXXXX

Momentary, 5/8" Threaded Front Mount

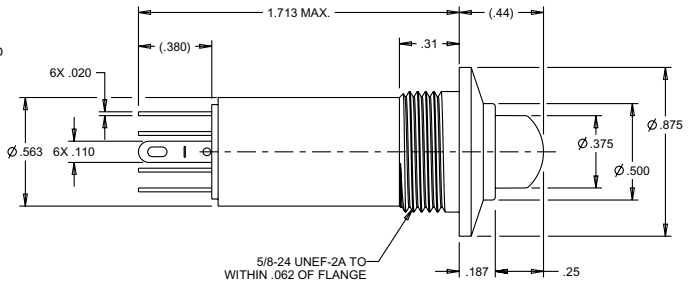
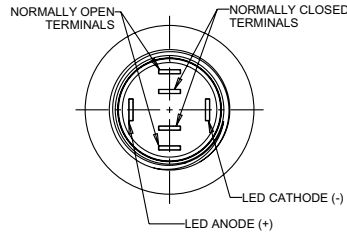
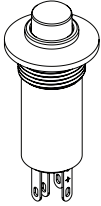

LP3-4XXXXXX

Momentary, 15/32" Threaded Rear Mount

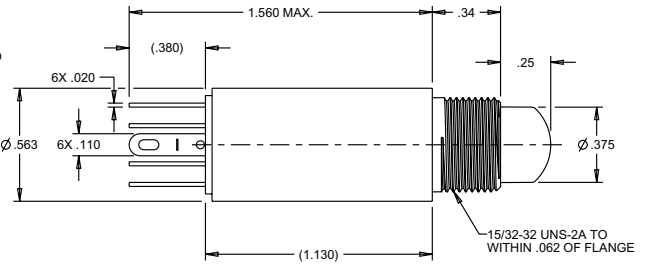
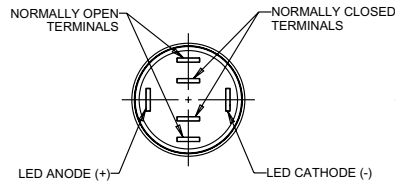
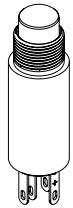

LP3-6XXXXXX

Momentary, 5/8" Threaded Rear Mount

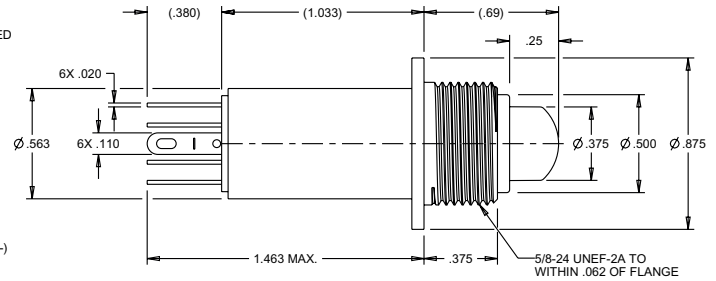
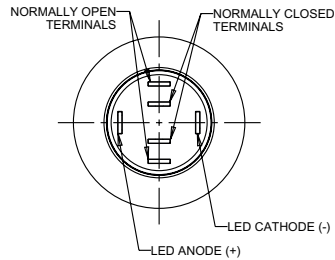
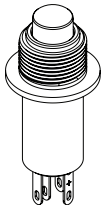

NOTE:

For indicator light only,
see LPL indicator light.

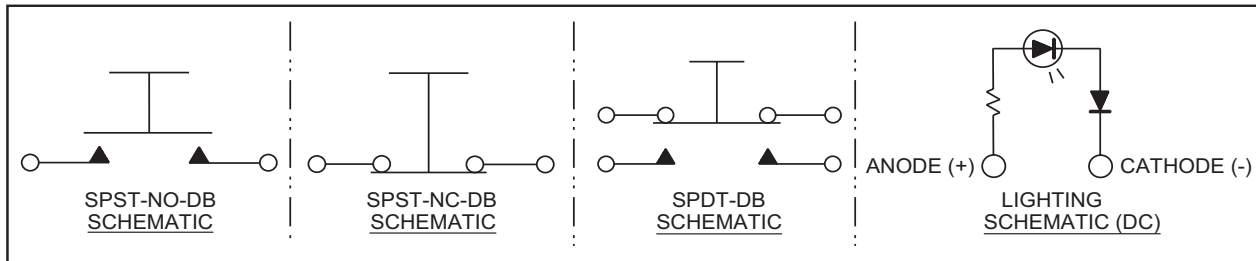

STANDARD LEGENDS PER SAE

STANDARD LEGENDS PER SAE SPECIFICATIONS

STANDARD LEGENDS PER SAE SPECIFICATIONS								
A1		ANCHOR	K2		UNLOCK	P5		BILGE BLOWER
B1		BATTERY	L1		LIGHT	R1		LIFT
B2		ELECTRIC POWER	L2		MASTER LIGHTING SWITCH	R2		LOWER
C1		AC/COOLING SYSTEMS	L3		HEADLIGHTS	R3		UP
C2		DEHUMIDIFIER	L4		HEADLIGHTS-LOW / DIPPED BEAM	R4		DOWN
C3		HEATER/INTERIOR HEATING	L5		HEADLIGHTS-HIGH / UPPER BEAM	R5		RIGHT
D1		WINDSHIELD DEFROSTER	L6		PARKING LIGHT	R6		LEFT
D2		REAR WINDOW DEFROSTER	L7		WORK LAMP	R7	FWD	FORWARD
D3		MIRROR DEFROSTER	L8		WORK LAMP	R8	REV	REVERSE
E1		ENGINE/START	L9		INTERIOR DOME LIGHT	S1		RADIO
E2		ENGINE/STOP	M1		BEACON	S2		MUTE
E3		ON/START	M2		HAZARD/POSITION LIGHTS	T1		FAST
E4	○	OFF/STOP	M3		CLEARANCE LIGHTS	T2		SLOW
E5	ON	ON	M4		SIDE MARKER LIGHT	T3		TRIM TAB / TRIMMING OPERATION
E6	OFF	OFF	M5		RUNNING LIGHTS (UNDER POWER)	T4		TRANSMISSION
E7		ENGINE ELECTRIC PREHEAT	M6		ANCHOR LIGHT	V1		VENTILATING / AC FAN
E8		ENGINE-GAS INJECTION	M7		RUNNING/ANCHOR LIGHTS	W1		WINDSHIELD WIPER
F1		FRONT FOG LIGHTS	M8		SEARCH LIGHT	W2		WINDSHIELD-WASHER
F2		REAR FOG LIGHTS	M9		LEFT TURN SIGNAL	W3		WINDSHIELD-WASHER/WIPER
G1		FUEL	MA		RIGHT TURN SIGNAL	W4		REAR WINDOW WIPER
H1		HORN	P1		BILGE PUMP #1	W5		REAR WINDOW-WASHER
H2		HORN REAR	P2		BILGE PUMP #2	W6		REAR WINDOW-WASHER/WIPER
K1		LOCK	P3		BILGE PUMP #3	ZZ		NO LEGEND
			P4		BILGE PUMP			

For legends not shown, please consult an OTTO representative.

LED VOLTAGE/CURRENT RATINGS TABLE

ROCKER AND ROTARY SWITCH VOLTAGE/CURRENT RATINGS TABLES

K1, K2, K3P and K4 LIGHTING VOLTAGE/CURRENT COMPONENTS RATINGS

LIGHT SOURCE VOLTAGE CATEGORY	LIGHT SOURCE COLOR	FORWARD CURRENT	TYPICAL FORWARD/ NOMINAL VOLTAGE	MAX. FORWARD VOLTAGE
6 VDC INCANDESCENT	WHITE	.2 AMPS	6 VDC	8 VDC
12 VDC INCANDESCENT	WHITE	.08 AMPS	12 VDC	14 VDC
24 VDC INCANDESCENT	WHITE	.04 AMPS	24 VDC	28 VDC
125 VAC NEON	AMBER	1.9 mA	125 VAC	125 VAC
250 VAC NEON	AMBER	1.9 mA	250 VAC	250 VAC
2 V LED PRODUCTS*	RED	20 mA	1.9 VDC	2.5 VDC
	GREEN	20 mA	2.15 VDC	2.5 VDC
	AMBER	20 mA	1.95 VDC	2.5 VDC
	BLUE	20 mA	3.5 VDC	4.0 VDC
6 V LED PRODUCTS	SEE CHART	20 mA	6 VDC	8 VDC
12 V LED PRODUCTS	SEE CHART	20 mA	12 VDC	14 VDC
24 V LED PRODUCTS	SEE CHART	20 mA	24 VDC	28 VDC

K3/K5 LIGHTING VOLTAGE/CURRENT COMPONENTS RATINGS

LIGHT SOURCE VOLTAGE CATEGORY	LIGHT SOURCE COLOR	FORWARD CURRENT	TYPICAL FORWARD/ NOMINAL VOLTAGE	MAX. FORWARD VOLTAGE
6 VDC INCANDESCENT	WHITE	.2 AMPS	6 VDC	8 VDC
12 VDC INCANDESCENT	WHITE	.08 AMPS	12 VDC	14 VDC
24 VDC INCANDESCENT	WHITE	.04 AMPS	24 VDC	28 VDC
125 VAC NEON	AMBER	1.9 mA	125 VAC	125 VAC
250 VAC NEON	AMBER	1.9 mA	250 VAC	250 VAC
2 V LED PRODUCTS*	RED	20 mA	2.0 VDC	2.5 VDC
	GREEN	20 mA	2.2 VDC	2.6 VDC
	AMBER	20 mA	2.1 VDC	2.5 VDC
6 V LED PRODUCTS	SEE CHART	20 mA	6 VDC	8 VDC
12 V LED PRODUCTS	SEE CHART	20 mA	12 VDC	14 VDC
24 V LED PRODUCTS	SEE CHART	20 mA	24 VDC	28 VDC

R2 LIGHTING VOLTAGE/CURRENT COMPONENTS RATINGS

LIGHT SOURCE VOLTAGE CATEGORY	LIGHT SOURCE COLOR	FORWARD CURRENT	TYPICAL FORWARD/ NOMINAL VOLTAGE	MAX. FORWARD VOLTAGE
2 V LED PRODUCTS*	RED	20 mA	2.0 VDC	2.5 VDC
	GREEN	20 mA	2.2 VDC	2.6 VDC
	AMBER	20 mA	2.1 VDC	2.5 VDC
6 V LED PRODUCTS	SEE CHART	20 mA	6 VDC	8 VDC
12 V LED PRODUCTS	SEE CHART	20 mA	12 VDC	14 VDC
24 V LED PRODUCTS	SEE CHART	20 mA	24 VDC	28 VDC

*Intended for use with external resistor. The "2 volt" switches are intended to have a resistor added in series into the lighting circuit by the customer. To determine the approximate value of the resistor, use the equation below:

$$\text{RESISTOR SIZE} = \frac{\text{POWER SUPPLY VOLTAGE} - \text{LED FORWARD VOLTAGE}}{\text{LED FORWARD CURRENT}}$$

LED VOLTAGE/CURRENT RATINGS TABLE

ILLUMINATED PUSHBUTTON SWITCH & INDICATOR LIGHTS VOLTAGE/CURRENT RATINGS TABLES

LP3, LP5 AND LPL SERIES LIGHTING VOLTAGE/CURRENT COMPONENTS RATINGS

LIGHT SOURCE VOLTAGE CATEGORY	LED COLOR	FORWARD CURRENT	TYP. FORWARD VOLTAGE (DC)	MAX. FORWARD VOLTAGE DC
2V* PRODUCTS	RED	20 mA	1.9V	2.5V
	GREEN	20 mA	2.2V	2.6V
	AMBER			
	BLUE	20 mA	3.3V	4V
	DEEP GREEN			
6V PRODUCTS	ALL COLORS	20 mA	6V	8V
12V PRODUCTS	ALL COLORS	20 mA	12V	14.5V
24V PRODUCTS	ALL COLORS	20 mA	24 V	28.6 V

LP3S LIGHTING VOLTAGE/CURRENT COMPONENTS RATINGS

LIGHT SOURCE VOLTAGE CATEGORY	LED COLOR	FORWARD CURRENT	TYP. FORWARD VOLTAGE	MAX. FORWARD VOLTAGE
2V* PRODUCTS	RED	20 mA	2 V	2.5 V
	GREEN			
	AMBER			
	BLUE	20 mA	3.2 V	4 V
	DEEP GREEN			
	WHITE			
12V PRODUCTS	ALL COLORS	20 mA	12V	14V
24V PRODUCTS	ALL COLORS	20 mA	24 V	28.6 V

LP7-D and LP9 SERIES LIGHTING VOLTAGE/CURRENT COMPONENTS RATINGS

LIGHT SOURCE VOLTAGE CATEGORY	LED COLOR, WAVELENGTH (nm)	FORWARD CURRENT	TYP. FORWARD VOLTAGE	MAX. FORWARD VOLTAGE
2V LIGHTPIPE STYLE	RED (631)	20 mA	2V	2.4V
	GREEN (525)	20 mA	3.2V	3.6V
	AMBER (591)	20 mA	2.1V	2.4V
	BLUE (470)	20 mA	3.3V	3.8V
	WHITE	5 mA	2.9V	3.15V
2V, TRANSLUCENT FULLY ILLUMINATED STYLE	RED (630)	20 mA	1.95V	2.5V
	GREEN (525)	20 mA	3.3V	4.1V
	AMBER (601)	20 mA	2.1V	2.5V
	BLUE (465)	20 mA	3.3V	4V
	WHITE	5 mA	2.85V	3.1V
12V ALL PRODUCTS	ALL COLORS, SAME AS 2V	(20 mA)	12.0V	14.0V

LP9L SERIES LIGHTING VOLTAGE/CURRENT COMPONENTS RATINGS				
LIGHT SOURCE VOLTAGE CATEGORY	LED COLOR, WAVELENGTH (nm)	FORWARD CURRENT	TYP. FORWARD VOLTAGE	MAX. FORWARD VOLTAGE
2V PRODUCTS	RED (631)	20 mA	2V	2.4V
	GREEN (525)	20 mA	3.2V	3.6V
	AMBER (591)	20 mA	2.1V	2.4V
	BLUE (470)	20 mA	3.3V	3.8V
	WHITE	5 mA	2.9V	3.15V
12V PRODUCTS	ALL COLORS, SAME AS 2V	(20 mA)	12.0V	14.0V

*Intended for use with external resistor. The "2 volt" switches are intended to have a resistor added in series into the lighting circuit by the customer. To determine the approximate value of the resistor, use the equation below:

$$\text{RESISTOR SIZE} = \frac{\text{POWER SUPPLY VOLTAGE} - \text{LED FORWARD VOLTAGE}}{\text{LED FORWARD CURRENT}}$$

X-ON Electronics

Largest Supplier of Electrical and Electronic Components

Click to view similar products for [Pushbutton Switches](#) category:

Click to view products by [OTTO](#) manufacturer:

Other Similar products are found below :

[8940K2012](#) [LW1L-M1C10V-A](#) [LW1L-M1C70-A](#) [LW2L-A1C20M-GD](#) [LW2L-M1C20M-A](#) [60324L](#) [M22-D-R-GB0/K11](#) [M7E-HRN2](#)
[67021K512](#) [67081K512X](#) [701PB580](#) [7199K101](#) [810K12910](#) [810KSV30B](#) [MML21EA2ADK](#) [MML21KA3ABK](#) [MML23KA3AC05K-001](#)
[MML23KW3AA01W](#) [8418K2](#) [8442K3](#) [8450K1](#) [860K11911T01A](#) [861901](#) [861K11911T01A07](#) [861K13810T00A14](#) [861K13911](#)
[8646AB6X718UL](#) [8646ABUL](#) [9001KXRK](#) [907AYY100](#) [PMHD155A1](#) [9533CD4+U574+U4922](#) [95-414.000](#) [99-450.837](#) [99-453.837](#)
[PV3H2B0NN-341](#) [1203MRA](#) [A22NZBGANGA](#) [A22NZBNANGA](#) [A22NZMPATRA](#) [A2PMA1X03EC56](#) [A3A-5123-02](#) [A3A-7140](#) [A3A-7310](#) [A3A-7340](#) [A3U-TMW-A2C-5M](#) [A595](#) [12037A2ULCSA](#) [ABD122N-B](#) [1211390004](#)