

ILLUMINATED VANDAL RESISTANT WITH LEGEND

MOMENTARY ACTION, FULLY ILLUMINATED, VANDAL RESISTANT CASE AND BUTTON WITH LEGEND

The LP3-V fully illuminated pushbutton, available with or without legend, is an extension of OTTO's LP3-V series. In addition to offering all the same functionality and robustness as the LP3-V, this momentary action, vandal resistant pushbutton switch offers an optional legend on a fully illuminated background for secure, reliable switching.

Standard offerings include 69 standard legends per SAE in silver or black. Custom legends and logos are also available.

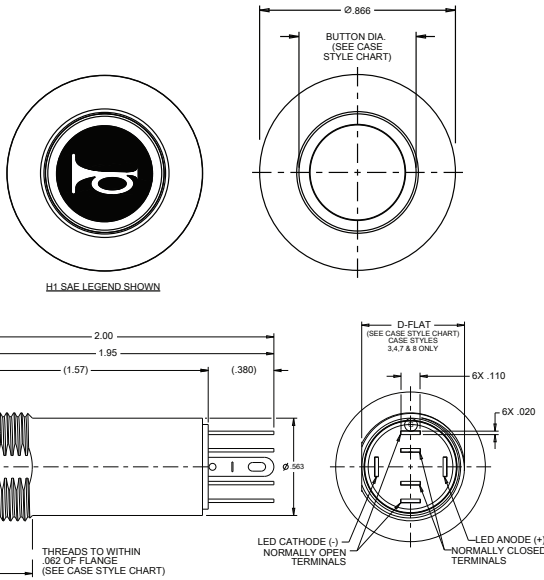

FULLY ILLUMINATED LP3-V PART NUMBER CODE

LP3	-	X		X		X		X		X		X		X			
Type	Case Style		Circuit Rating		LED Light Source Type** w/ Rev. Pol Protection		Seal Level		Operating Force		Case/Center Cap Color		Button Profile		Legend Color		Legend
A. Aluminum	1. 5/8-24 & Hex Nut		1. SPST N.O./Std.		A. 2V Red		2. Dusttight		2. 2.5 lbs. (± 0.5 lbs.)		3. Silver/Translucent (Fully Illuminated) ^②		1. High Profile Flat Button		1. Silver		SAE Legend, Two Digit Code: please refer to Appendix
V. Stainless	2. 5/8-24 & Knurl Nut*		2. SPST N.C./Std.		B. 2V Green***		3. Watertight		5. 5.0 lbs. (± 1.0 lbs.)		4. Black/Translucent (Fully Illuminated) ^{①②}		2. High Profile Curved Button		2. Black		
	3. 5/8-24 W/D-Flat & Hex Nut		3. SPDT 2 Circuit/Std.		C. 2V Amber								3. Low Profile Flat Button				
	4. 5/8-24 W/D-Flat & Knurl Nut*		4. SPST N.O./Logic Level		D. 6V Red								4. Low Profile Curved Button				
	5. 3/4-20 & Hex Nut		5. SPST N.C./Logic Level		E. 6V Green***								5. Flush Profile Flat Button				
	6. 3/4-20 & Knurl Nut*		6. SPDT 2 Circuit/Logic Level		F. 6V Amber												
	7. 3/4-20 W/D-Flat & Hex Nut				G. 12V Red												
	8. 3/4-20 W/D-Flat & Knurl Nut*				H. 12V Green***												
					J. 12V Amber												
					K. 24V Red												
					L. 24V Green***												
					M. 24V Amber												
					N. 2V Blue												
					P. 6V Blue												
					Q. 12V Blue												
					R. 24V Blue												
					S. 2V Deep Green												
					T. 6V Deep Green												
					U. 12V Deep Green												
					V. 24V Deep Green												

CASE STYLE		
DIMENSION (BUTTON DIA.)	1 - 4	5 - 8
(BUTTON DIA.)	0.525	0.590
(THREAD)	5/8-24 UNEF-2A	3/4-20 UNEF-2A
FLAT	0.594	0.718

STOP HERE for lighted switches without legends

* Contact factory for Knurl Nut option
 ** 2V LED's are intended for use with an external resistor. See appendix for complete voltage/ratings table. For additional LED lighting options, contact factory.
 *** Light source not available with fully illuminated center cap

① Only available on LP3-A styles.
 ② Not offered in case styles 5, 6, 7, and 8.

ILLUMINATED VANDAL RESISTANT PUSHBUTTONS

MOMENTARY ACTION RING ILLUMINATED, VANDAL RESISTANT CASE & BUTTON

LP3-XXXXXXX1
High Profile Flat Button

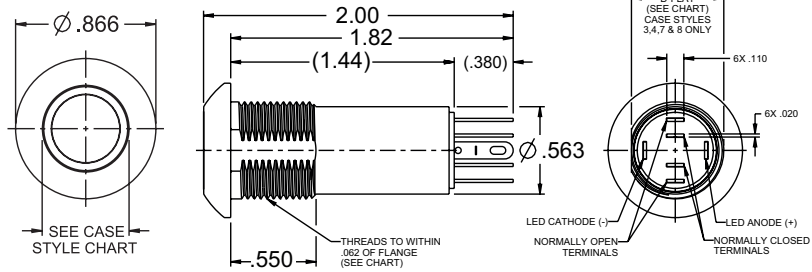
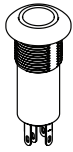

LP3-XXXXXXX2
High Profile Curved Button

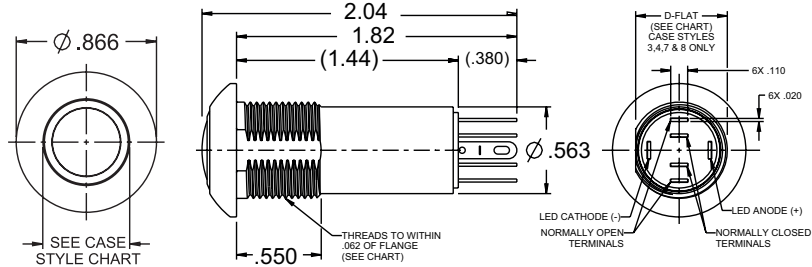
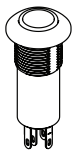

LP3-XXXXXXX3
Low Profile Flat Button

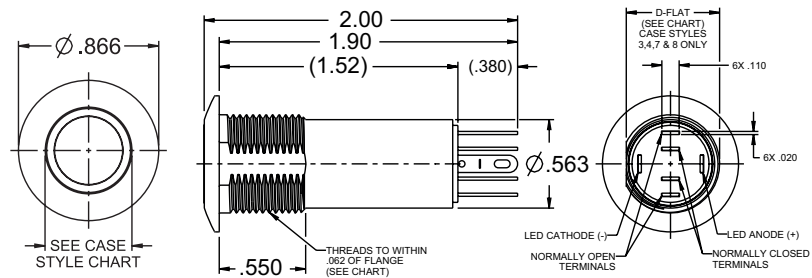
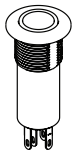

LP3-XXXXXXX4
Low Profile Curved Button

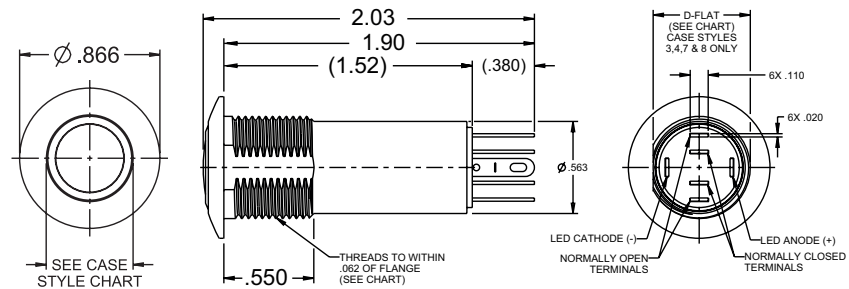
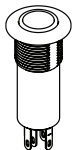

LP3-XXXXXXX5
Flush Profile Flat Button

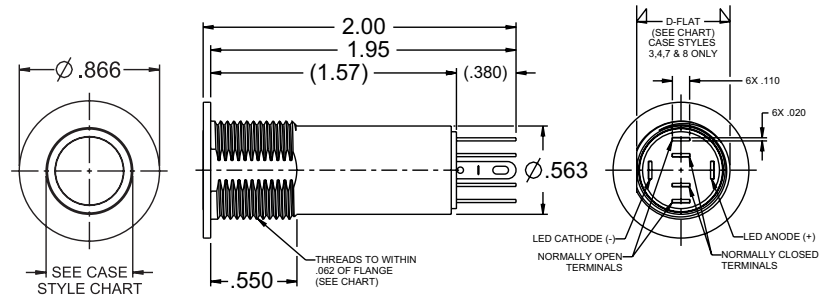
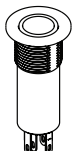

CASE STYLE		
DIMENSION	1 - 4	5 - 8
(BUTTON DIA.)	0.525	0.590
(THREAD)	5/8-24 UNEF-2A	3/4-20 UNEF-2A
FLAT	0.594	0.718

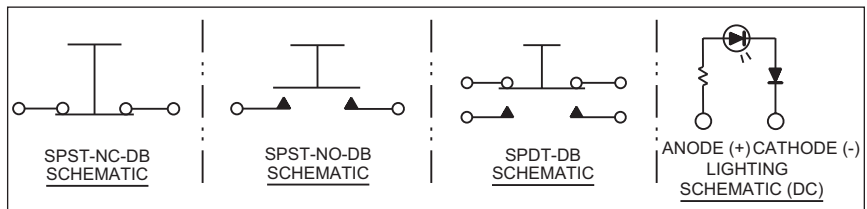

STANDARD LEGENDS PER SAE

STANDARD LEGENDS PER SAE SPECIFICATIONS

STANDARD LEGENDS PER SAE SPECIFICATIONS								
A1		ANCHOR	K2		UNLOCK	P5		BILGE BLOWER
B1		BATTERY	L1		LIGHT	R1		LIFT
B2		ELECTRIC POWER	L2		MASTER LIGHTING SWITCH	R2		LOWER
C1		AC/COOLING SYSTEMS	L3		HEADLIGHTS	R3		UP
C2		DEHUMIDIFIER	L4		HEADLIGHTS-LOW / DIPPED BEAM	R4		DOWN
C3		HEATER/INTERIOR HEATING	L5		HEADLIGHTS-HIGH / UPPER BEAM	R5		RIGHT
D1		WINDSHIELD DEFROSTER	L6		PARKING LIGHT	R6		LEFT
D2		REAR WINDOW DEFROSTER	L7		WORK LAMP	R7	FWD	FORWARD
D3		MIRROR DEFROSTER	L8		WORK LAMP	R8	REV	REVERSE
E1		ENGINE/START	L9		INTERIOR DOME LIGHT	S1		RADIO
E2		ENGINE/STOP	M1		BEACON	S2		MUTE
E3		ON/START	M2		HAZARD/POSITION LIGHTS	T1		FAST
E4	○	OFF/STOP	M3		CLEARANCE LIGHTS	T2		SLOW
E5	ON	ON	M4		SIDE MARKER LIGHT	T3		TRIM TAB / TRIMMING OPERATION
E6	OFF	OFF	M5		RUNNING LIGHTS (UNDER POWER)	T4		TRANSMISSION
E7		ENGINE ELECTRIC PREHEAT	M6		ANCHOR LIGHT	V1		VENTILATING / AC FAN
E8		ENGINE-GAS INJECTION	M7		RUNNING/ANCHOR LIGHTS	W1		WINDSHIELD WIPER
F1		FRONT FOG LIGHTS	M8		SEARCH LIGHT	W2		WINDSHIELD-WASHER
F2		REAR FOG LIGHTS	M9		LEFT TURN SIGNAL	W3		WINDSHIELD-WASHER/WIPER
G1		FUEL	MA		RIGHT TURN SIGNAL	W4		REAR WINDOW WIPER
H1		HORN	P1		BILGE PUMP #1	W5		REAR WINDOW-WASHER
H2		HORN REAR	P2		BILGE PUMP #2	W6		REAR WINDOW-WASHER/WIPER
K1		LOCK	P3		BILGE PUMP #3	ZZ		NO LEGEND
			P4		BILGE PUMP			

For legends not shown, please consult an OTTO representative.

X-ON Electronics

Largest Supplier of Electrical and Electronic Components

Click to view similar products for [Pushbutton Switches](#) category:

Click to view products by [OTTO](#) manufacturer:

Other Similar products are found below :

[8940K2012](#) [LW1L-M1C10V-A](#) [LW1L-M1C70-A](#) [LW2L-A1C20M-GD](#) [LW2L-M1C20M-A](#) [60324L](#) [M22-D-R-GB0/K11](#) [M7E-HRN2](#)
[67021K512](#) [67081K512X](#) [701PB580](#) [7199K101](#) [810K12910](#) [810KSV30B](#) [MML21EA2ADK](#) [MML21KA3ABK](#) [MML23KA3AC05K-001](#)
[MML23KW3AA01W](#) [8418K2](#) [8442K3](#) [8450K1](#) [860K11911T01A](#) [861901](#) [861K11911T01A07](#) [861K13810T00A14](#) [861K13911](#)
[8646AB6X718UL](#) [8646ABUL](#) [9001KXRK](#) [907AYY100](#) [PMHD155A1](#) [9533CD4+U574+U4922](#) [95-414.000](#) [99-450.837](#) [99-453.837](#)
[PV3H2B0NN-341](#) [1203MRA](#) [A22NZBGANGA](#) [A22NZBNANGA](#) [A22NZMPATRA](#) [A2PMA1X03EC56](#) [A3A-5123-02](#) [A3A-7140](#) [A3A-7310](#) [A3A-7340](#) [A3U-TMW-A2C-5M](#) [A595](#) [12037A2ULCSA](#) [ABD122N-B](#) [1211390004](#)