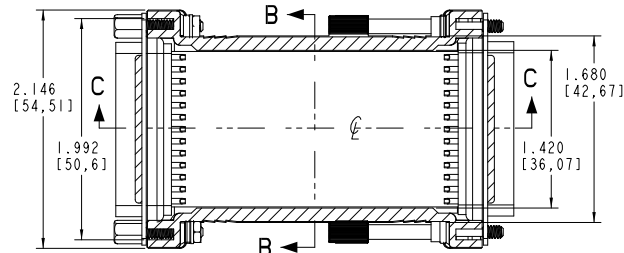
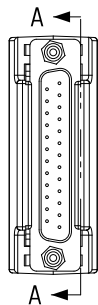
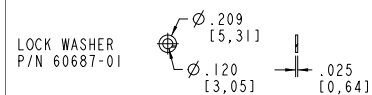
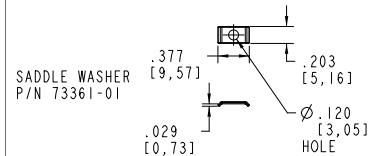
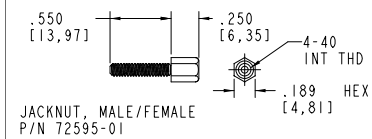
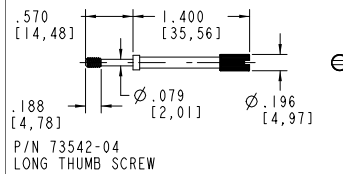
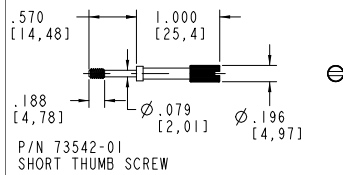
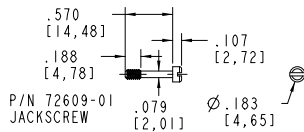
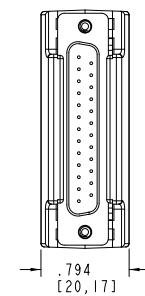

**TABLE 2**

ALL HARDWARE IS 4-40, ALL SCREWS AND THUMB SCREWS ARE CAPTIVE. THE JACK NUT IS NOT CAPTIVE AND THIS ITEM CAN BE THREADED INTO THE HOUSING, OR THE HOLE CAN BE ENLARGED.



**SECTION A-A**



TOP AND BOTTOM COVER  
SEE TABLE 1 FOR P/N

CONNECTORS  
AND PC BOARD  
NOT SUPPLIED

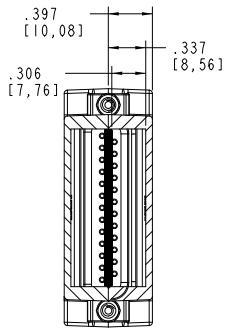
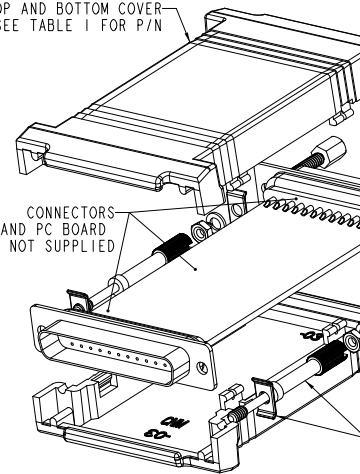

**SECTION B-B**

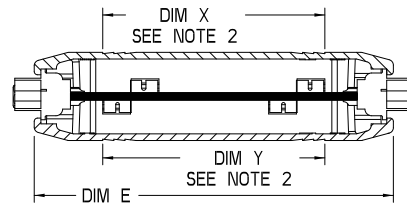

**SECTION C-C**

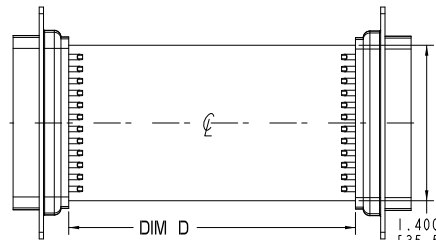
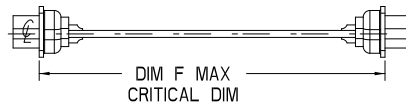

NOTES:

1. ACTUAL PCB LENGTH AS A PRODUCT OF CONNECTORS SELECTED.
2. DIM X AND Y ARE TOP AND BOTTOM AREA X 1.450 [36,83] WIDE.
3. HARDWARE TO BE ORDERED SEPARATE PER CUSTOMER SPECIFIC REQUIREMENT

**TABLE 1**

CN SIZE	S	M	L
HOUSING PART NUMBER	CNS-0303	CNM-0303	CNL-0303
DIM D PCB SIZE	SEE NOTE 1		
DIM E OVERALL SIZE	2.734 [69,44]	3.234 [82,14]	3.734 [94,84]
DIM F MAX CRITICAL DIM	2.610 [66,29]	3.110 [79,0]	3.610 [91,69]
DIM X & Y	1.500	2.000	2.500

DB25 STRAIGHT CONNECTOR TO DB25 STRAIGHT CONNECTOR

**PACINTEC**  
1-610-361-4200

**CN-0303 SERIES**  
SEE TABLE 1

VISIT **PACINTEC**  
ON THE WORLD WIDE WEB  
[www.pacintecenclosures.com](http://www.pacintecenclosures.com)

COLOR /  
COLOR  
BLACK  
P.C.BON

## X-ON Electronics

Largest Supplier of Electrical and Electronic Components

*Click to view similar products for* [Enclosures, Boxes & Cases](#) *category:*

*Click to view products by* [PacTec](#) *manufacturer:*

Other Similar products are found below :

[585-R-WH-PK](#) [M-10-PLATED](#) [60221-01](#) [60566-01-000](#) [HPL-9VB BATT DOOR](#) [M18-PLTD](#) [M-21-PLATED](#) [63310-01-000](#) [6711GSKT](#)  
[71884-29-028](#) [LH45-100 Black](#) [72868-510-000](#) [CNS-0000 Black](#) [72883-510-000](#) [CNS-0101 Black](#) [72906-510-000](#) [CNS-0407 Black](#) [73092-](#)  
[510-000](#) [CNM-0101 Black](#) [73105-510-000](#) [CNL-0101 Black](#) [73108-510-000](#) [CNL-0303 Black](#) [73395-510-039](#) [CNS-0006 Bone](#) [74257-510-000](#)  
[CNL-0004](#) [MDC-1183-PLAIN-ALUM](#) [MDC-1183-PTD](#) [MDC-13104-PTD](#) [MDC-321-PTD](#) [MDC-973-PTD](#) [76](#) [77153-01-028](#) [FLX6030](#)  
[83535-01-508](#) [90026-501-000](#) [PS36-200](#) [116-508](#) [120-407](#) [120-910](#) [127-908](#) [130-008](#) [1301170079](#) [1322GSKTEP](#) [1325GSKT3](#) [1434-1210](#)  
[EAS-500 \(BLACK ANO\)](#) [1804RP-RB-PK](#) [190-005](#) [2202307](#) [KAB3321 BLACK](#) [KAB3421](#) [2697466](#) [S52213](#) [2901123](#) [2901699](#) [A0645271](#)  
[A20P20](#) [2106-IR](#) [PERF-850-PLN](#)