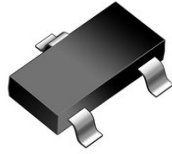
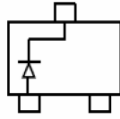

SOT-23

Features

Extremely Fast Switching Speed
Epitaxial planar die construction
Halogen free and RoHS compliant

Mechanical Data

SOT-23 Small Outline Plastic Package
EpoxyUL:94V-0

MARKING:

BAT54 MARKING: KL1

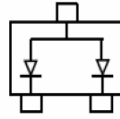

BAT54A MARKING: KL2

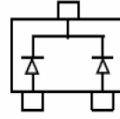

BAT54C MARKING: KL3

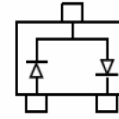

BAT54S MARKING: KL4

BAT54	BAT54A	BAT54C	BAT54S

Summary of Packing Options

Package	Packing Description	Packing Quantity	Industry Standard
SOT-23	Tape/Reel,7" reel	3000	EIA-481-1

Maximum Ratings & Thermal Characteristics

(Ratings at 25°C ambient temperature unless otherwise specified.)

Parameter	Symbol	Value	Unit
Peak Repetitive Reverse Voltage	V_{RRM}		
Working Peak Reverse Voltage	V_{RWM}	30	V
DC Blocking Voltage	V_R		
Forward Continuous Current	I_{FM}	200	mA
Non-repetitive Peak Forward Surge Current @ $t=8.3ms$	I_{FSM}	600	mA
Repetitive Peak Forward Current @ $t \leq 1s, \delta \leq 0.5$	I_{FRM}	300	mA
Power Dissipation	P_D	200	mW
Thermal Resistance from Junction to Ambient	$R_{\theta JA}$	500	°C/W
Junction Temperature	T_J	125	°C
Storage Temperature	T_{stg}	-55~+150	°C

Electrical Characteristics

(Ratings at 25°C ambient temperature unless otherwise specified.)

Parameter	Symbol	Min	Typ	Max	Unit	Test conditions
Reverse voltage	$V_{(BR)}$		30		V	$I_R=100\mu A$
Forward voltage	V_F			0.24	V	$I_{F1}=0.1mA$
				0.32	V	$I_{F2}=1mA$
				0.40	V	$I_{F3}=10mA$
				0.50	V	$I_{F4}=30mA$
				1	V	$I_{F5}=100mA$
Reverse current	I_R			2	μA	$V_R=25V$
Diode capacitance	C_D			10	pF	$V_R=1V, f=1MHz$
Reverse recovery time	t_{rr}			5	ns	$I_F=I_R=10mA$ $I_{rr}=0.1 \times I_R, R_L=100 \Omega$

Ratings and Characteristic Curves

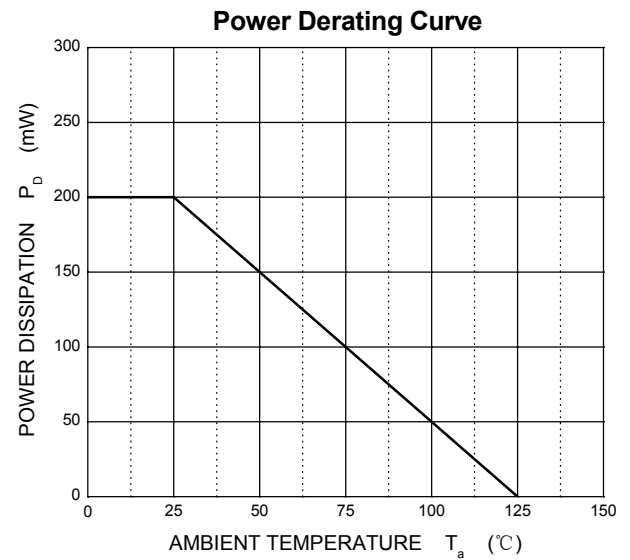
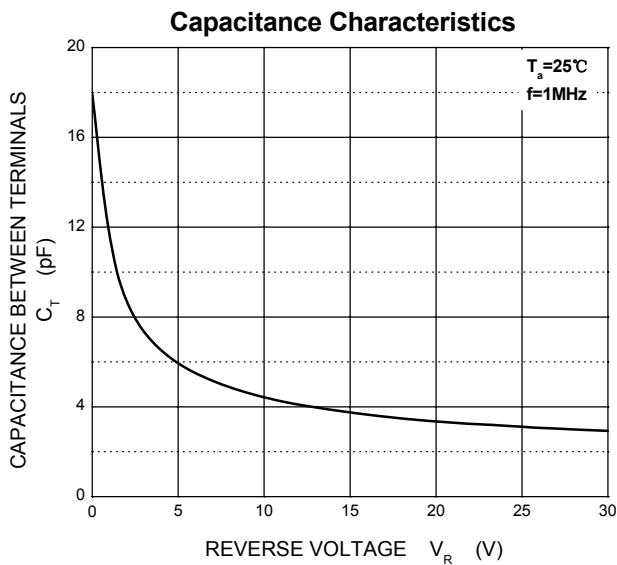
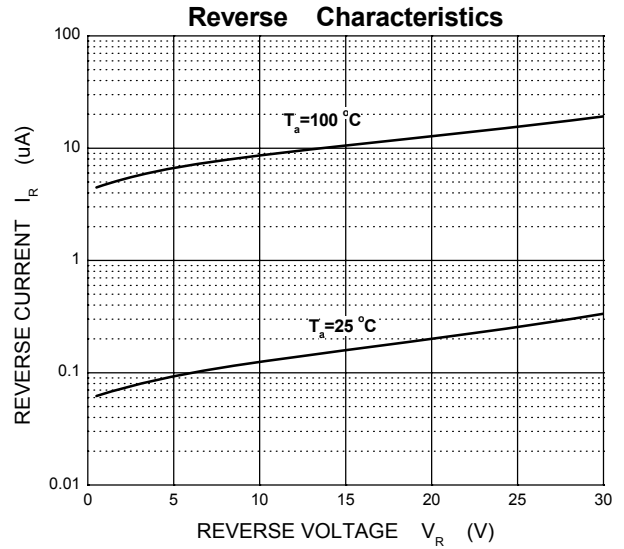
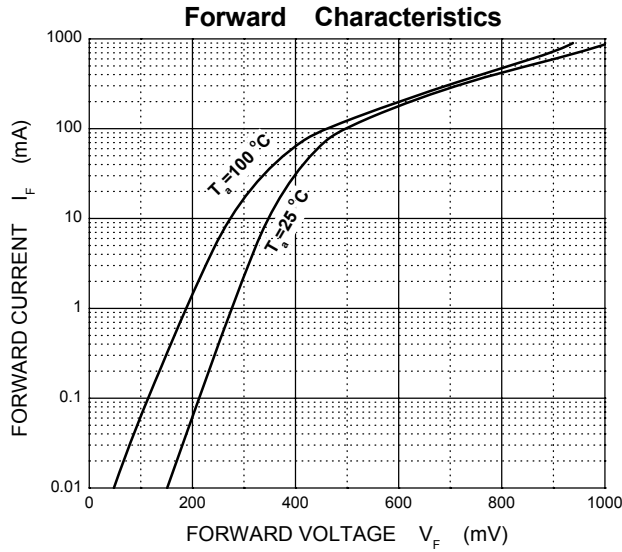

Package Outline Dimensions: SOT-23

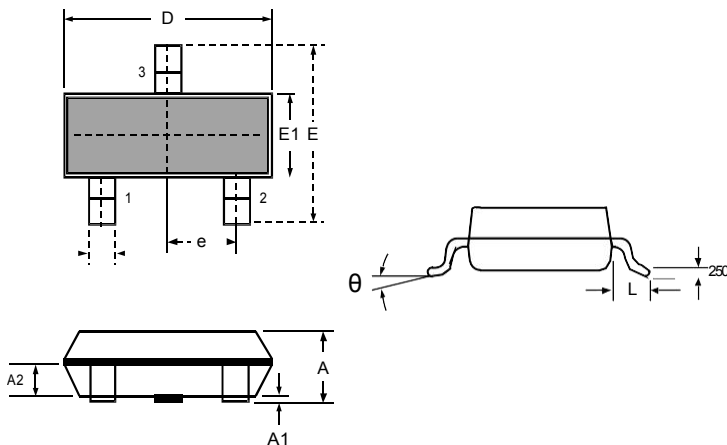

DIMENSIONS

SYMBOL	MILLIMETER		INCHES	
	MIN	MAX	MIN	MAX
A	0.900	1.150	0.035	0.045
A1	0.000	0.100	0.000	0.004
A2	0.900	1.050	0.035	0.041
D	2.800	3.000	0.110	0.118
b	0.300	0.500	0.012	0.020
E	2.250	2.550	0.089	0.100
E1	1.200	1.400	0.047	0.055
e	0.950 BSC		0.037 BSC	
L	0.300	0.500	0.012	0.020
θ	0	8°	0	8°

X-ON Electronics

Largest Supplier of Electrical and Electronic Components

Click to view similar products for [Schottky Diodes & Rectifiers](#) category:

Click to view products by [PAKER Microelectronics](#) manufacturer:

Other Similar products are found below :

[MA4E2039](#) [MA4E2508M-1112](#) [MBR1545CT](#) [MMBD301M3T5G](#) [RB160M-50TR](#) [D83C](#) [BAS16E6433HTMA1](#) [BAT 54-02LRH E6327](#)
[NRVBAF360T3G](#) [NSR05F40QNXT5G](#) [NTE555](#) [JANS1N6640](#) [SK310-T](#) [SS3003CH-TL-E](#) [GA01SHT18](#) [CRS10I30A\(TE85L,QM](#)
[MA4E2501L-1290](#) [MBRA140TRPBF](#) [MBRB30H30CT-1G](#) [BAT 15-04R E6152](#) [JANTX1N5712-1](#) [DMJ3940-000](#) [SB007-03C-TB-E](#)
[SK33B-TP](#) [NRVBB20100CTT4G](#) [NRVBM120LT1G](#) [NTSB30U100CT-1G](#) [VS-6CWQ10FNHM3](#) [CRG04\(T5L,TEMQ\)](#) [ACDBA1100LR-HF](#)
[ACDBA1200-HF](#) [ACDBA240-HF](#) [ACDBA3100-HF](#) [CDBQC0530L-HF](#) [CDBQC0240LR-HF](#) [ACDBA260LR-HF](#) [ACDBA1100-HF](#)
[MA4E2502L-1246](#) [10BQ015-M3/5BT](#) [NRVBM120ET1G](#) [CRS08TE85LQM](#) [PMAD1108-LF](#) [B120Q-13-F](#) [1N5819T-G](#) [B0530WSQ-7-F](#)
[PDS1040Q-13](#) [B160BQ-13-F](#) [SDM05U20CSP-7](#) [B140S1F-7](#) [HSM560Je3/TR13](#)