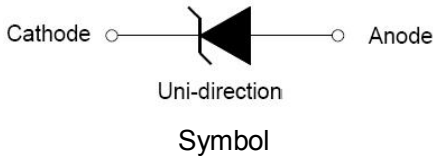
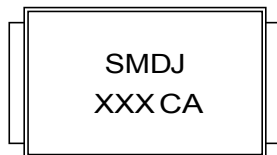
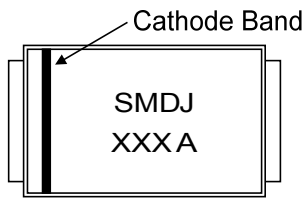

SMC

Features

- Peak power dissipation 3000W@10 x 1000 us Pulse
- Low incremental surge resistance
- Excellent clamping capability
- Glass passivated junction
- Fast response time
- Low leakage current
- Halogen free and RoHS compliant

Mechanical Data

- CASE: SMCJ(DO-214AB) Molded Plastic
- Polarity: By cathode band denotes uni-directional device, none cathode band denotes bi-directional device
- Mounting Position:Any

Making Code & information

Package	Packing Description	Packing Quantity
SMC	Tape/Reel,13" reel	3000

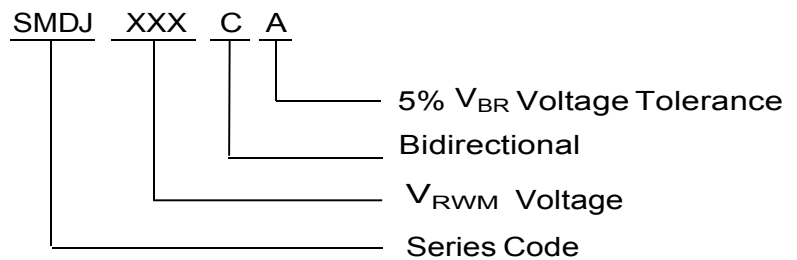
Maximum Ratings & Thermal Characteristics

(Ratings at 25°C ambient temperature unless otherwise specified.)

Parameter	Symbol	Value	Units	Remarks
Peak Pulse Power Dissipation	P_{PPM}	3000	W	(Note1)(Note2)
Steady State Power Dissipation	P_D	6.5	W	(Note3)
Peak Forward Surge Current	I_{FSM}	300	A	(Note4)
Maximum Instantaneous Forward Voltage at 100A	V_{FM}	3.5/5	V	(Note5)
Typical Thermal Resistance Junction to Lead	$R_{\theta JL}$	15	°C/W	
Typical Thermal Resistance Junction to Ambient	$R_{\theta JA}$	75	°C/W	
Operating Temperature Range	T_J	-55 to 150	°C	
Storage Temperature Range	T_{STG}	-55 to 150	°C	

Notes1: Non-repetitive current pulse , 10/1000us Waveform.

Notes2: Mounted on copper pad area of 8×8mm to each terminal.

Notes3: Infinite HeatSink at $T_A=50^\circ\text{C}$

Notes4: Measured on 8.3ms single half sine wave or equivalent square wave, duty cycle=4 perminute maximum.

Notes5: For UnidirectionalOnly, $V_{FM}<3.5\text{V}$ for $V_{BR}\leq 200\text{V}$ and $V_{FM}<5.0\text{V}$ for $V_{BR}\geq 201\text{V}$.

Electrical Characteristics

(Ratings at 25°C ambient temperature unless otherwise specified).

Part Number		Reverse Stand off Voltage V_R (V)	Breakdown Voltage V_{BR} @ I_T (V)		Test Current I_T (mA)	Maximum Clamping Voltage V_C @ I_{PP} (V)	Maximum Peak Pulse Current I_{PP} (A)	Maximum Reverse Leakage I_R @ V_R (μ A)
			Min	Max				
Uni	Bi							
SMDJ5.0A	SMDJ5.0CA	5	6.4	7	10	9.2	326.1	500
SMDJ6.0A	SMDJ6.0CA	6	6.67	7.37	10	10.3	291.3	500
SMDJ6.5A	SMDJ6.5CA	6.5	7.22	7.98	10	11.2	267.9	300
SMDJ7.0A	SMDJ7.0CA	7	7.78	8.6	10	12	250	200
SMDJ7.5A	SMDJ7.5CA	7.5	8.33	9.21	1	12.9	232.6	100
SMDJ8.0A	SMDJ8.0CA	8	8.89	9.83	1	13.6	220.6	50
SMDJ8.5A	SMDJ8.5CA	8.5	9.44	10.4	1	14.4	208.3	20
SMDJ9.0A	SMDJ9.0CA	9	10	11.1	1	15.4	194.8	10
SMDJ10A	SMDJ10CA	10	11.1	12.3	1	17	176.5	5
SMDJ11A	SMDJ11CA	11	12.2	13.5	1	18.2	164.8	2
SMDJ12A	SMDJ12CA	12	13.3	14.7	1	19.9	150.8	2
SMDJ13A	SMDJ13CA	13	14.4	15.9	1	21.5	139.5	2
SMDJ14A	SMDJ14CA	14	15.6	17.2	1	23.2	129.3	2
SMDJ15A	SMDJ15CA	15	16.7	18.5	1	24.4	123	2
SMDJ16A	SMDJ16CA	16	17.8	19.7	1	26	115.4	2
SMDJ17A	SMDJ17CA	17	18.9	20.9	1	27.6	108.7	2
SMDJ18A	SMDJ18CA	18	20	22.1	1	29.2	102.7	2
SMDJ20A	SMDJ20CA	20	22.2	24.5	1	32.4	92.6	2
SMDJ22A	SMDJ22CA	22	24.4	26.9	1	35.5	84.5	2
SMDJ24A	SMDJ24CA	24	26.7	29.5	1	38.9	77.1	2
SMDJ26A	SMDJ26CA	26	28.9	31.9	1	42.1	71.3	2
SMDJ28A	SMDJ28CA	28	31.1	34.4	1	45.4	66.1	2
SMDJ30A	SMDJ30CA	30	33.3	36.8	1	48.4	62	2
SMDJ33A	SMDJ33CA	33	36.7	40.6	1	53.3	56.3	2
SMDJ36A	SMDJ36CA	36	40	44.2	1	58.1	51.6	2
SMDJ40A	SMDJ40CA	40	44.4	49.1	1	64.5	46.5	2
SMDJ43A	SMDJ43CA	43	47.8	52.8	1	69.4	43.2	2
SMDJ45A	SMDJ45CA	45	50	55.3	1	72.7	41.3	2
SMDJ48A	SMDJ48CA	48	53.3	58.9	1	77.4	38.8	2
SMDJ51A	SMDJ51CA	51	56.7	62.7	1	82.4	36.4	2
SMDJ54A	SMDJ54CA	54	60	66.3	1	87.1	34.4	2
SMDJ58A	SMDJ58CA	58	64.4	71.2	1	93.6	32.1	2
SMDJ60A	SMDJ60CA	60	66.7	73.7	1	96.8	31	2
SMDJ64A	SMDJ64CA	64	71.1	78.6	1	103	29.1	2
SMDJ70A	SMDJ70CA	70	77.8	86	1	113	26.5	2
SMDJ75A	SMDJ75CA	75	83.3	92.1	1	121	24.8	2
SMDJ78A	SMDJ78CA	78	86.7	95.8	1	126	23.8	2
SMDJ85A	SMDJ85CA	85	94.4	104	1	137	21.9	2
SMDJ90A	SMDJ90CA	90	100	111	1	146	20.5	2
SMDJ100A	SMDJ100CA	100	111	123	1	162	18.5	2
SMDJ110A	SMDJ110CA	110	122	135	1	177	16.9	2
SMDJ120A	SMDJ120CA	120	133	147	1	193	15.5	2
SMDJ130A	SMDJ130CA	130	144	159	1	209	14.4	2
SMDJ150A	SMDJ150CA	150	167	185	1	243	12.3	2
SMDJ160A	SMDJ160CA	160	178	197	1	259	11.6	2
SMDJ170A	SMDJ170CA	170	189	209	1	275	10.9	2
SMDJ180A	SMDJ180CA	180	198	230.4	1	292	10.3	2
SMDJ220A	SMDJ220CA	220	242	281.6	1	356	8.4	2

Ratings and Characteristic Curves

(Ratings at 25°C ambient temperature unless otherwise specified).

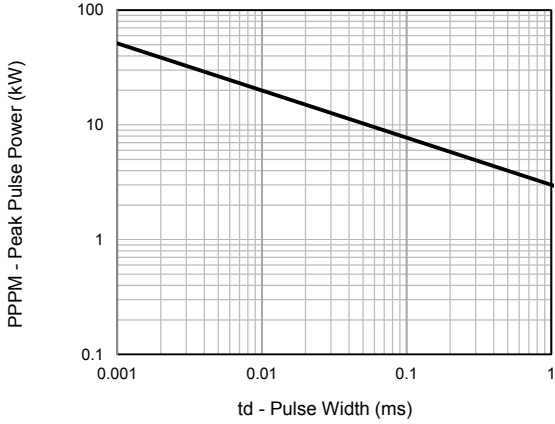

Fig.1 - Peak Pulse Power Rating

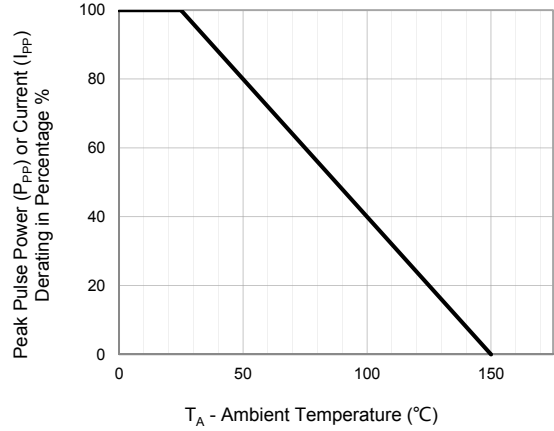

Fig.2 - Pulse Derating Curve

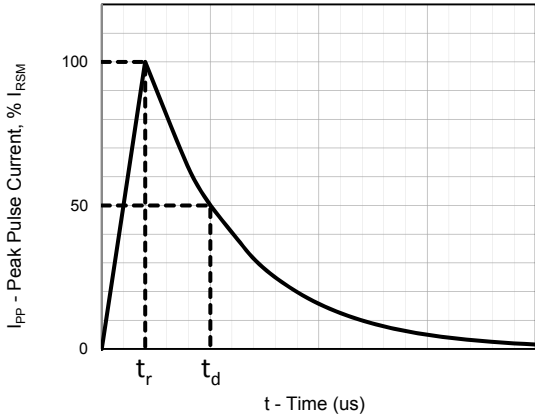

Fig.3 - Pulse Waveform

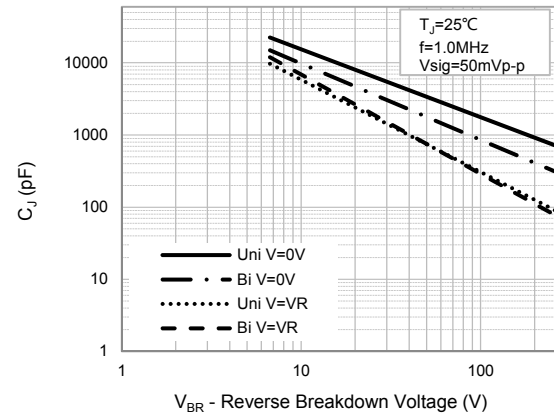

Fig.4 - Typical Junction Capacitance

Package Outline Dimensions: SMC(DO-214AB)

Dim	Millimeters		Inches	
	Min	Max	Min	Max
L	6.75	6.95	0.265	0.274
D	5.75	5.95	0.226	0.234
D1	2.9	3.1	0.114	0.122
T	7.9	8.1	0.311	0.319
T1	0.85	1.3	0.034	0.051
d	-	0.2	-	0.008
H	2.45	2.65	0.096	0.104
H1	2.3	2.5	0.09	0.098

X-ON Electronics

Largest Supplier of Electrical and Electronic Components

Click to view similar products for [ESD Suppressors / TVS Diodes](#) category:

Click to view products by [PAKER Microelectronics](#) manufacturer:

Other Similar products are found below :

[60KS200C](#) [D18V0L1B2LP-7B](#) [D5V0F4U5P5-7](#) [NTE4902](#) [P4KE27CA](#) [P6KE11CA](#) [P6KE8.2A](#) [SA60CA](#) [SA64CA](#) [SMBJ12CATR](#)
[SMBJ33CATR](#) [SMBJ6.5A](#) [SMBJ8.0A](#) [ESD101-B1-02ELS](#) [E6327](#) [ESD112-B1-02EL](#) [E6327](#) [ESD7451N2T5G](#) [19180-510](#) [CPDT-5V0USP-](#)
[HF](#) [3.0SMCJ33CA-F](#) [3.0SMCJ36A-F](#) [HSPC16701B02TP](#) [JANTX1N6126A](#) [D3V3Q1B2DLP3-7](#) [D55V0M1B2WS-7](#) [SCM1293A-04SO](#)
[ESD200-B1-CSP0201](#) [E6327](#) [SM12-7](#) [CEN955 W/DATA](#) [VESD12A1A-HD1-GS08](#) [CPDQC5V0-HF](#) [D1213A-01LP4-7B](#) [ESD101-B1-02EL](#)
[E6327](#) [AOZ8808DI-03](#) [5KP15A](#) [5KP48A](#) [5KP90A](#) [ESD3V3D7-TP](#) [15KPA36A-LF](#) [P4KE56CA](#) [P4KE68A](#) [P4KE91CATR](#) [P6KE120A](#)
[P6KE13CA](#) [P6KE43CA](#) [P6KE6.8CA](#) [P6KE8.2](#) [P6SMBJ20CA](#) [JANTX1N6072A](#) [SR2835ESKG](#) [SA90CA](#)