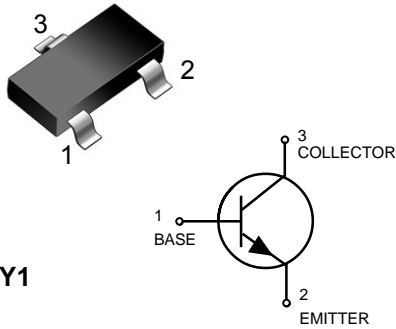

SOT-23

MARKING: Y1
Features

As complementary type the PNP transistor SS8550 is recommended
 Collector current : $I_C=1.5A$
 Epitaxial planar die construction
 Halogen free and RoHS compliant

Mechanical Data

SOT-23 Small Outline Plastic Package
 EpoxyUL: 94V-0

Summary of Packing Options

Package	Packing Description	Packing Quantity	Industry Standard
SOT-23	Tape/Reel,7" reel	3000	EIA-481-1

Maximum Ratings & Thermal Characteristics

(Ratings at 25°C ambient temperature unless otherwise specified.)

Parameters	Symbol	Value	Unit
Collector-Base Voltage	V_{CBO}	40	V
Collector-Emitter Voltage	V_{CEO}	25	V
Emitter -Base Voltage	V_{EBO}	5	V
Collector Current-Continuous	I_C	1500	mA
Collector Power Dissipation	P_C	300	mW
Junction Temperature	T_j	150	°C
Storage Temperature	T_{stg}	-55-+150	°C
Thermal resistance From junction to ambient	$R_{\theta JA}$	417	°C/W

Electrical Characteristics

(Ratings at 25°C ambient temperature unless otherwise specified).

Parameter	Symbol	Test conditions	MIN	TYP	MAX	UNIT
Collector-base breakdown voltage	$V_{(BR)CBO}$	$I_C=100\mu A, I_E=0$	40			V
Collector-emitter breakdown voltage	$V_{(BR)CEO}$	$I_C=0.1mA, I_B=0$	25			V
Emitter-base breakdown voltage	$V_{(BR)EBO}$	$I_E=100\mu A, I_C=0$	5			V
Collector cut-off current	I_{CBO}	$V_{CB}=40V, I_E=0$			0.1	μA
Emitter cut-off current	I_{EBO}	$V_{EB}=5V, I_C=0$			0.1	μA
DC current gain	$h_{FE(1)}$	$V_{CE}=1V, I_C=100mA$	120		400	
	$h_{FE(2)}$	$V_{CE}=1V, I_C=800mA$	40			
Collector-emitter saturation voltage	$V_{CE(sat)}$	$I_C=800mA, I_B=80mA$			0.5	V
Base-emitter saturation voltage	$V_{BE(sat)}$	$I_C=800mA, I_B=80mA$			1.2	V
Transition frequency	f_T	$V_{CE}=10V, I_C=50mA$ $f=30MHz$	100			MHz

CLASSIFICATION OF $h_{FE(1)}$

RANK	L	H	J
RANGE	120-200	200-350	300-400

Ratings and Characteristic Curves

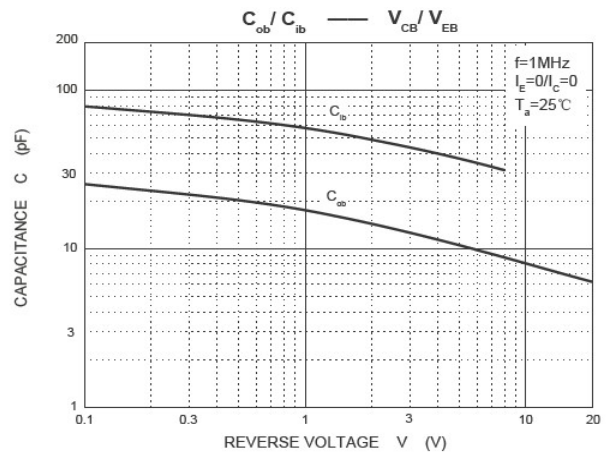
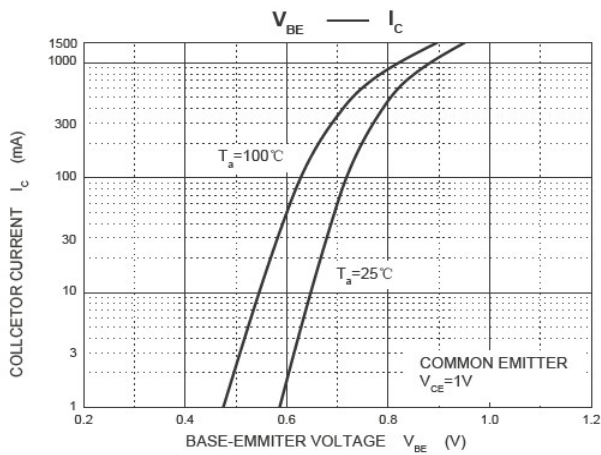
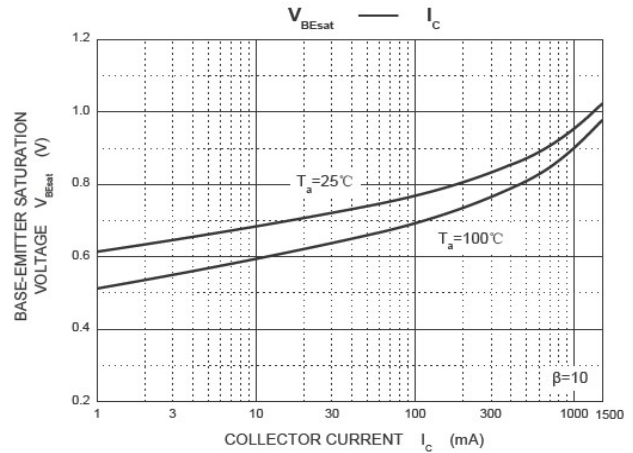
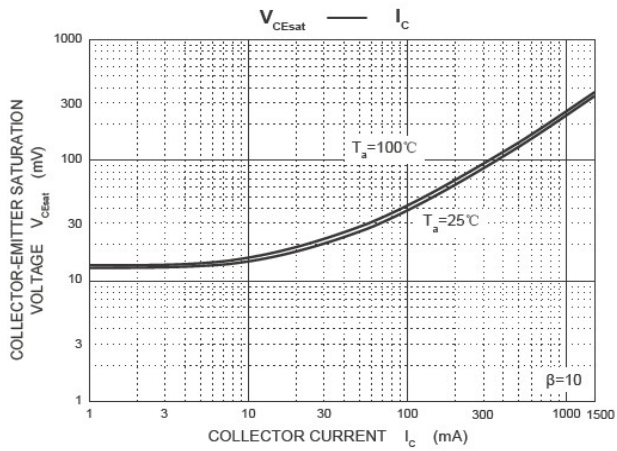
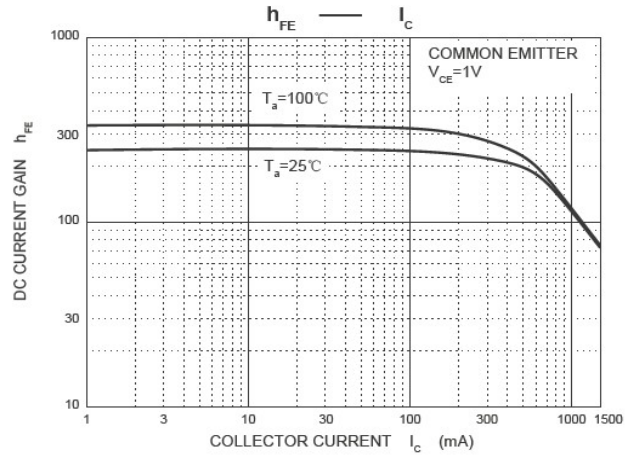
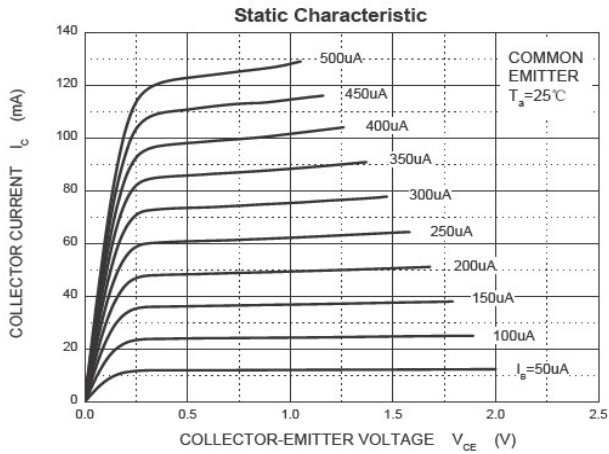

Package Outline Dimensions: SOT-23

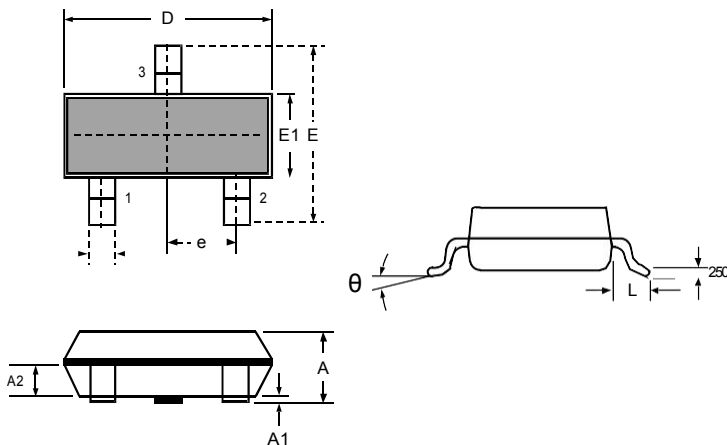

DIMENSIONS

SYMBOL	MILLIMETER		INCHES	
	MIN	MAX	MIN	MAX
A	0.900	1.150	0.035	0.045
A1	0.000	0.100	0.000	0.004
A2	0.900	1.050	0.035	0.041
D	2.800	3.000	0.110	0.118
b	0.300	0.500	0.012	0.020
E	2.250	2.550	0.089	0.100
E1	1.200	1.400	0.047	0.055
e	0.950 BSC		0.037 BSC	
L	0.300	0.500	0.012	0.020
θ	0	8°	0	8°

X-ON Electronics

Largest Supplier of Electrical and Electronic Components

Click to view similar products for [Bipolar Transistors - BJT category](#):

Click to view products by [PAKER Microelectronics manufacturer](#):

Other Similar products are found below :

[BC559C](#) [MCH4017-TL-H](#) [MMBT-2369-TR](#) [BC546/116](#) [NJVMJD148T4G](#) [NTE16](#) [NTE195A](#) [IMX9T110](#) [2N4401-A](#) [2N4403](#) [2N6728](#)
[2SA1419T-TD-H](#) [2SA2126-E](#) [2SB1204S-TL-E](#) [FMC5AT148](#) [2N2369ADCSM](#) [2N2907A](#) [2N3904-NS](#) [2N5769](#) [2SC4618TLN](#) [CPH6501-](#)
[TL-E](#) [MCH4021-TL-E](#) [Jantx2N5416](#) [US6T6TR](#) [BAX18/A52R](#) [BC556/112](#) [IMZ2AT108](#) [MMST8098T146](#) [UMX21NTR](#) [MCH6102-TL-E](#)
[TTA1452B,S4X\(S](#) [2N3879](#) [NTE13](#) [NTE282](#) [NTE323](#) [NTE350](#) [NTE81](#) [JANTX2N2920L](#) [JANTX2N3735](#) [JANSR2N2222AUB](#)
[CMLT3946EG TR](#) [SNSS40600CF8T1G](#) [CMLT3906EG TR](#) [GRP-DATA-JANS2N2907AUB](#) [GRP-DATA-JANS2N2222AUA](#)
[MMDT3946FL3-7](#) [2N4240](#) [MSB30KH-13](#) [2N2221AUB](#) [2SD1815T-TL-E](#)