

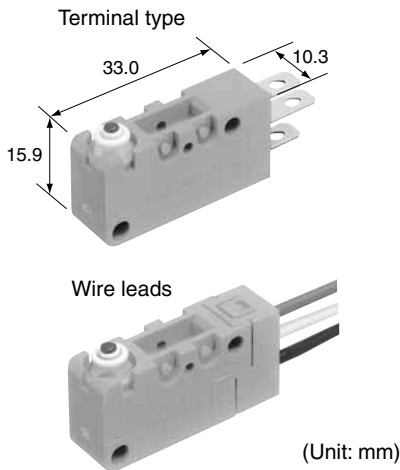

Miniature Size Sealed Switches

TURQUOISE SWITCHES ABV (BV) SWITCHES



FEATURES

- Integral construction of body and cover, sealed switches
- Long life (Mechanical life: Min. 5×10^6)
- Wide variation.

TYPICAL APPLICATIONS

- Automotive
- Agricultural machinery (Combine, Rice planting machine)
- Ice maker, etc.

RoHS compliant

ORDERING INFORMATION

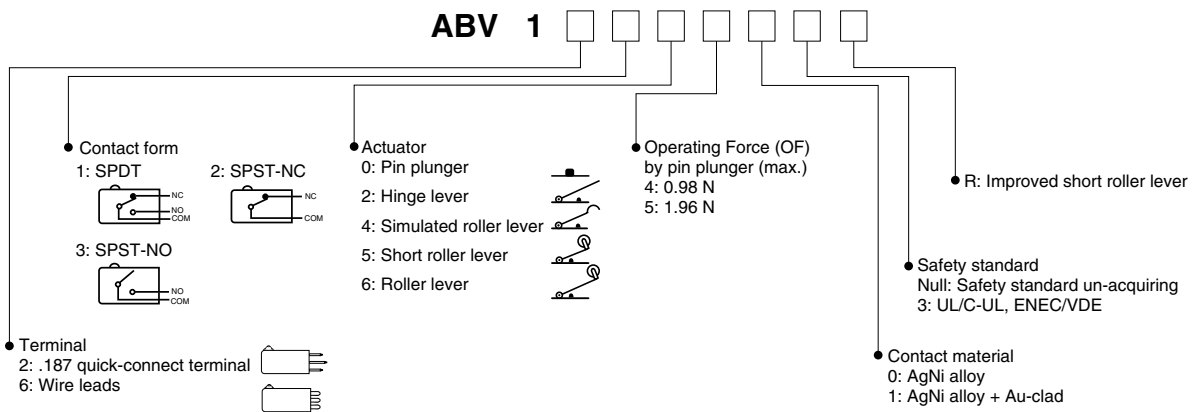

Notes: 1. Standard packing: Dust protected type 50 pcs./carton, 500 pcs./case; Immersion protected type 50 pcs./case.
2. Not every combination is available. Please refer to the following table, "PRODUCT TYPES".

CONSTRUCTION

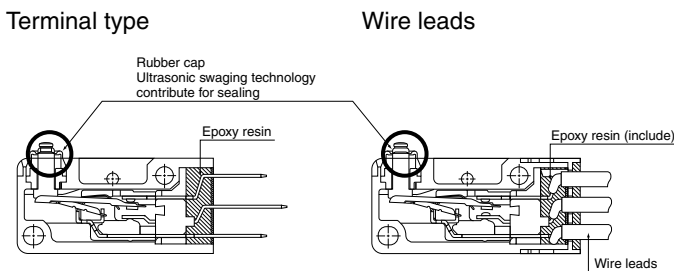

APPLICABLE CURRENT RANGE (Reference)

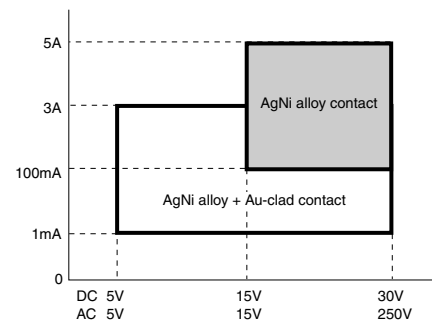

PRODUCT TYPES

■ AgNi alloy contact type

Actuator	Contact form	Operating Force OF, Max.	.187 Quick-connect terminal	
			Part number	Wire Leads Part number
Pin plunger	SPDT	0.98 N	ABV1210403	ABV1610403
		1.96 N	ABV1210503	ABV1610503
	SPST-NC	0.98 N	ABV1220403	ABV1620403
		1.96 N	ABV1220503	ABV1620503
	SPST-NO	0.98 N	ABV1230403	ABV1630403
		1.96 N	ABV1230503	ABV1630503
Hinge lever	SPDT	0.59 N	ABV1212403	ABV1612403
		1.18 N	ABV1212503	ABV1612503
	SPST-NC	0.59 N	ABV1222403	ABV1622403
		1.18 N	ABV1222503	ABV1622503
	SPST-NO	0.59 N	ABV1232403	ABV1632403
		1.18 N	ABV1232503	ABV1632503
Simulated roller lever	SPDT	0.59 N	ABV1214403	ABV1614403
		1.18 N	ABV1214503	ABV1614503
	SPST-NC	0.59 N	ABV1224403	ABV1624403
		1.18 N	ABV1224503	ABV1624503
	SPST-NO	0.59 N	ABV1234403	ABV1634403
		1.18 N	ABV1234503	ABV1634503
Short roller lever	SPDT	1.08 N	ABV1215403R	ABV1615403R
		2.16 N	ABV1215503R	ABV1615503R
	SPST-NC	1.08 N	ABV1225403R	ABV1625403R
		2.16 N	ABV1225503R	ABV1625503R
	SPST-NO	1.08 N	ABV1235403R	ABV1635403R
		2.16 N	ABV1235503R	ABV1635503R
Roller lever	SPDT	0.59 N	ABV1216403	ABV1616403
		1.18 N	ABV1216503	ABV1616503
	SPST-NC	0.59 N	ABV1226403	ABV1626403
		1.18 N	ABV1226503	ABV1626503
	SPST-NO	0.59 N	ABV1236403	ABV1636403
		1.18 N	ABV1236503	ABV1636503

■ AgNi alloy + Au-clad contact type

Actuator	Contact form	Operating Force OF, Max.	.187 Quick-connect terminal	
			Part number	Wire Leads Part number
Pin plunger	SPDT	0.98 N	ABV1210413	ABV1610413
		1.96 N	ABV1210513	ABV1610513
	SPST-NC	0.98 N	ABV1220413	ABV1620413
		1.96 N	ABV1220513	ABV1620513
	SPST-NO	0.98 N	ABV1230413	ABV1630413
		1.96 N	ABV1230513	ABV1630513
Hinge lever	SPDT	0.59 N	ABV1212413	ABV1612413
		1.18 N	ABV1212513	ABV1612513
	SPST-NC	0.59 N	ABV1222413	ABV1622413
		1.18 N	ABV1222513	ABV1622513
	SPST-NO	0.59 N	ABV1232413	ABV1632413
		1.18 N	ABV1232513	ABV1632513
Simulated roller lever	SPDT	0.59 N	ABV1214413	ABV1614413
		1.18 N	ABV1214513	ABV1614513
	SPST-NC	0.59 N	ABV1224413	ABV1624413
		1.18 N	ABV1224513	ABV1624513
	SPST-NO	0.59 N	ABV1234413	ABV1634413
		1.18 N	ABV1234513	ABV1634513
Short roller lever	SPDT	1.08 N	ABV1215413R	ABV1615413R
		2.16 N	ABV1215513R	ABV1615513R
	SPST-NC	1.08 N	ABV1225413R	ABV1625413R
		2.16 N	ABV1225513R	ABV1625513R
	SPST-NO	1.08 N	ABV1235413R	ABV1635413R
		2.16 N	ABV1235513R	ABV1635513R
Roller lever	SPDT	0.59 N	ABV1216413	ABV1616413
		1.18 N	ABV1216513	ABV1616513
	SPST-NC	0.59 N	ABV1226413	ABV1626413
		1.18 N	ABV1226513	ABV1626513
	SPST-NO	0.59 N	ABV1236413	ABV1636413
		1.18 N	ABV1236513	ABV1636513

SPECIFICATIONS

Rating

	Standard rating	Low-level rating
AgNi alloy + Au-clad contact Plunger color: Red	3 A 250 V AC (OF 1.96 N), 1 A 250 V AC (OF 0.98 N)	6 V DC 5 mA, 12 V DC 2 mA, 24 V DC 1 mA
AgNi alloy contact Plunger color: Black	5 A 250 V AC (OF 1.96 N), 3 A 250 V AC (OF 0.98 N)	—

Characteristics

Item		Specifications	
Expected life	Mechanical life (OT: Specified value)	Min. 5×10^6 (at 60 cpm)	
	Electrical life	Nominal rating (OT: Max.)	Min. 10^5 (at 20 cpm)
		Low-level rating (OT: Specified value)	Min. 10^6 (at 20 cpm) OF 0.98N type is Min 5×10^5 (at 20 com)
Insulation resistance		Min. 100 MΩ (at 500 V DC insulation resistance meter)	
Dielectric strength	Between non-continuous terminals	1,000 Vrms	
	Between each terminal and other exposed metal parts	2,000 Vrms	
	Between each terminal and ground	2,000 Vrms	
Vibration resistance		10 to 55 Hz at single amplitude of 0.75 mm (Contact opening: max. 1 msec.)	
Shock resistance		Min. 294 m/s ² (Contact opening: Max. 1 msec.)	
Contact resistance	AgNi alloy contact type	Terminal type: Max. 50 mΩ Wire leads: Max. 100 mΩ (by voltage drop 1 A 6 to 8 V DC)	
	AgNi alloy + Au-clad contact type	Terminal type: Max. 50 mΩ Wire leads: Max. 100 mΩ (by voltage drop 0.1 A 6 to 8 V DC)	
Allowable operating speed		1 to 500 mm/sec.	
Max. operating cycle rate		120 cpm	
Ambient temperature		-40°C to +85°C	
Unit weight		Approx. 7 g (Terminal type)	
Protection grade		IP67 (except exposed terminal part of terminal type)	

Note: Test conditions and judgement are complying with "NECA C4505".

Operating characteristics

Actuator	8th digit of Part No.	Operating Force OF, Max.	Release Force RF, Min.	Pretravel PT, Max.	Movement Differential MD, Max.	Overtravel OT, Min.	Operating position OP
Pin plunger	4	0.98N	0.25N	1.6 mm	0.4 mm	0.8 mm	14.7±0.6 mm
	5	1.96N	0.39N	1.6 mm	0.4 mm	0.8 mm	14.7±0.6 mm
Hinge lever	4	0.59N	0.098N	3.2 mm	1.2 mm	1.2 mm	15.3±1.2 mm
	5	1.18N	0.13N	3.2 mm	1.2 mm	1.2 mm	15.3±1.2 mm
Simulated roller lever	4	0.59N	0.098N	3.2 mm	1.2 mm	1.2 mm	18.5±1.2 mm
	5	1.18N	0.13N	3.2 mm	1.2 mm	1.2 mm	18.5±1.2 mm
Short roller lever	4	1.08N	0.20N	1.6 mm	0.5 mm	0.8 mm	20.7±0.8 mm
	5	2.16N	0.39N	1.6 mm	0.5 mm	0.8 mm	20.7±0.8 mm
Roller lever	4	0.59N	0.098N	3.2 mm	1.2 mm	1.2 mm	20.7±1.2 mm
	5	1.18N	0.13N	3.2 mm	1.2 mm	1.2 mm	20.7±1.2 mm

DIMENSIONS

(Unit: mm) General tolerance: ±0.4

The CAD data of the products with a **CAD Data** mark can be downloaded from: <http://industrial.panasonic.com/ac/e/>

.187 quick-connect terminal

Pin plunger

CAD Data



External dimensions

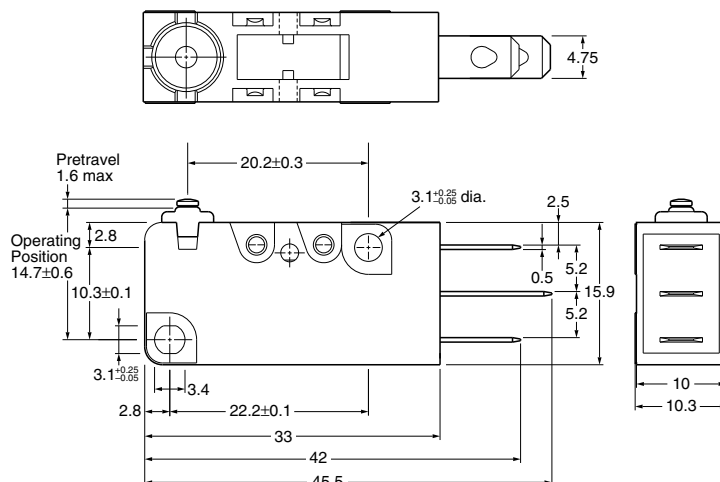

Pretravel PT, Max.	1.6mm
Movement Differential MD, Max.	0.4mm
Overtravel OT, Min.	0.8mm
Operating Position OP	14.7±0.6mm

ABV (BV) Turquoise Switches

Hinge lever

CAD Data



External dimensions

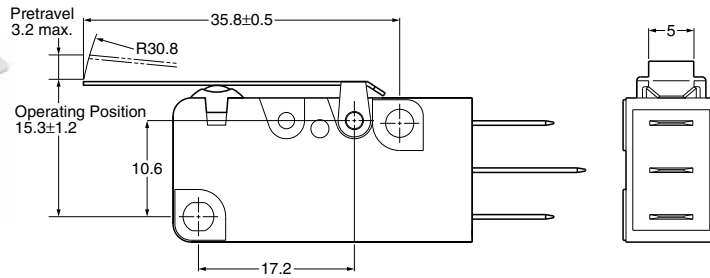

Pretravel PT, Max.	3.2mm
Movement Differential MD, Max.	1.2mm
Overtravel OT, Min.	1.2mm
Operating Position OP	15.3±1.2mm

Simulated roller lever

CAD Data



External dimensions

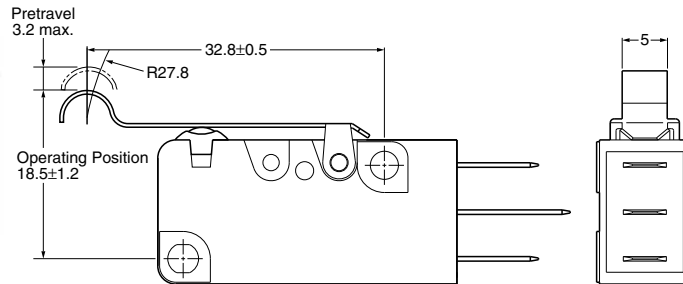

Pretravel PT, Max.	3.2mm
Movement Differential MD, Max.	1.2mm
Overtravel OT, Min.	1.2mm
Operating Position OP	18.5±1.2mm

Short roller lever

CAD Data



External dimensions

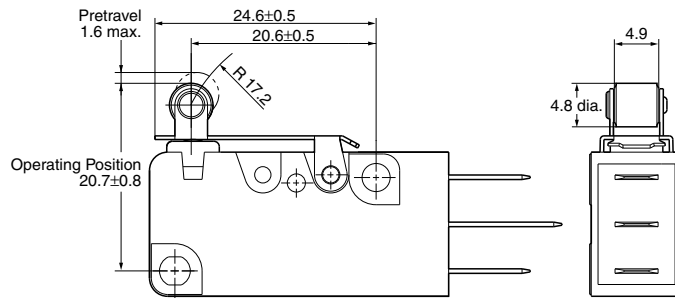

Pretravel PT, Max.	1.6mm
Movement Differential MD, Max.	0.5mm
Overtravel OT, Min.	0.8mm
Operating Position OP	20.7±0.8mm

Roller lever

CAD Data



External dimensions

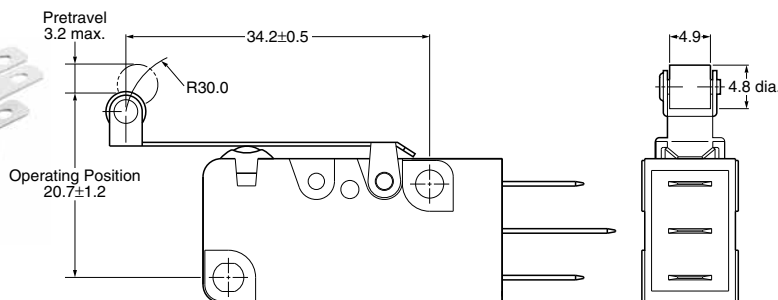

Pretravel PT, Max.	3.2mm
Movement Differential MD, Max.	1.2mm
Overtravel OT, Min.	1.2mm
Operating Position OP	20.7±1.2mm

Wire Leads

CAD Data



External dimensions

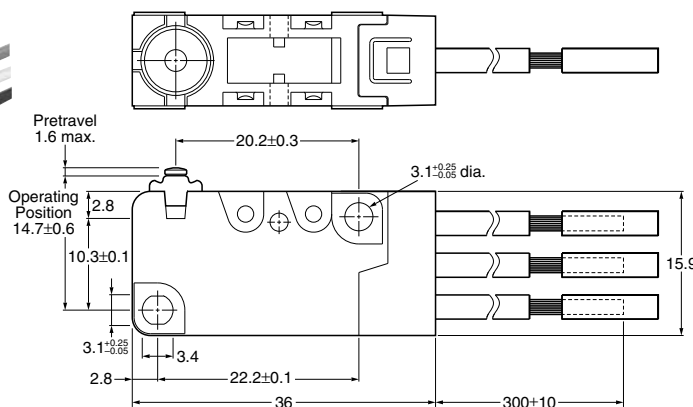

- Notes: 1. Dimensions of the actuator types are the same as those of corresponding solder and .187 quick-connect terminal types.
2. With UL and CSA approved products, lead wire is changed to UL compliant (AWG18).

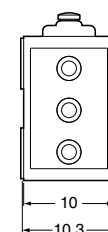

Thickness of the lead wire:
0.75mm² (Note 2)
Color of the lead wire
NCred
NOwhite
COM ...black

Notes for Turquoise Switches (BJ, BS, BV type)

CAUTIONS FOR USE (Common for BJ, BS and BV types)

■ Fastening of the switch body

1) Fasten the switch body onto a smooth surface using the correct screw as shown in the chart below and tighten it with the prescribed torque.

The switch case may deform depending on the type of screw (screw head diameter, etc.), the size of the washer, and the use or non-use of a washer. Therefore, please confirm the appropriate torque of actual conditions. Also, it is recommended that adhesive be applied to lock the screws to prevent loosening of the screws. When doing so, please be careful not let any adhesive get inside the switch.

	Screws	Tightening torque
ABJ (BJ) switches	M1.2	Not more than 0.098N·m
	M2.3	Not more than 0.29N·m
	M3.0	Not more than 0.29N·m
ABS (BS) switches	M2.3	Not more than 0.29N·m
ABV (BV) switches	M3.0	Not more than 0.49N·m

2) Fixed pin type

To secure the switch unit, thermally crimp or press-fit the mounting pins. If the pins are to be press-fitted, install a guide on the opposite surface to the mounting pins to prevent them from slipping out of position and developing play.

3) Be sure to maintain adequate insulating clearance between each terminal and ground.

4) The positioning of the switch should be such that direct force is not applied to the pushbutton or actuator in its free position. The operating force to the pushbutton should only be applied in a perpendicular direction.

5) The standard value of overtravel used should be within the range of 70% to 100% of the rated OT value.

6) When soldering the BV type turquoise switch or the immersion protected type of the BJ and BS type switches, the sealing material sometimes forms a lump or bulge at the base of the terminal or lead. Be sure to allow enough space for this when attaching the switch.

■ Soldering operations

1) Manual soldering: Perform soldering in less than 3 seconds with maximum 350°C iron. Care should be taken not to apply force to the terminals during soldering. We recommend a soldering iron with temperature adjustment in order to prevent poor quality soldering.

Please consult us if you intend to use a soldering iron of 60 W or higher.

2) Terminal portions should not be moved within 1 minute after soldering.

	Soldering time
ABJ (BJ) switches	Within 3 seconds
ABS (BS) switches	Within 3 seconds
ABV (BV) switches	Within 5 seconds

■ Selection of the switch

Allow for up to $\pm 20\%$ variation of the specified characteristics values to compensate for long term operational wear of the switch in your design.

■ Cautions regarding use

1) When switching inductive loads (relays, solenoids, buzzers, etc.), an arc absorbing circuit is recommended to protect the contacts.

2) If switching of the contact is synchronized with the phase of the AC power, reduced electrical life or welded contact may occur. Therefore, test the switch while it is operating under actual loads for this condition. If found, you may wish to take corrective action in your design.

3) In the slow or high speed operating condition, the electrical life might be greatly reduced depending upon the switching load. Please consult us before use.

4) Using lever type in do not condition, there is the concern that the flexible part may be impeded and return movement may not be possible. In this situation take the following precautions:

- Select a product of higher OF or use a leaf type lever.
- Attach a protective cover to the lever.

5) If the leaf lever type switch is excessively pushed (pushed further than the operational limit position) or switching is done at high speed or is accompanied by the impact, the lever will break. Please be careful. Also, be careful with the short roller lever type ABV (BV) switch as improper return may result from pressing too much.

■ Protection from dust, water and corrosive gas

1) The pin button and the space around the body cap Turquoise switches are sealed with elastic material, the terminal portion is integrally molded. This prevents dust entry and protects the switch against corrosive gases. Wireleaded types are recommended for applications subject to water or oil splash. However, avoid soaking these immersion protected types in oil or water, because those types are not of completely oil tight construction.

2) Switch operation or rapid temperature change while water droplets are on the switch may cause the water invasion inside the switch because of breathing action on condensation. Especially do not use switch in a bath.

If sources of silicon gas are existing in the vicinity of the switch (silicon rubber, silicon oil, silicon coating, and silicon filler, etc.), silicon gas (low molecular siloxane, etc.) will be emitted and it will get into the product due to the permeability of the plastic. If the switch is used or stored in such an environment, silicon compound might generate on the contacts, cause the and faulty contacting. Therefore, please do not use sources that can emit silicon gas in the vicinity of the switch.

Do not use in areas where flammable or explosive gases from gasoline and thinner, etc., may be present.

Notes for Turquoise Switches (BJ, BS, BV type)

• Dust protection test

Test conditions: The talcum powder used shall be able to pass through a square- meshed sieve the nominal wire diameter of 7 μm . The amount of talcum powder to be used is 2 kg per cubic metre of the test chamber volume. The duration of the test is 8 hours.

No damage observed after the test.

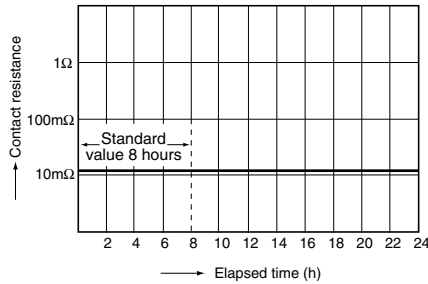

• Waterproof test

Test conditions: Immersion protected IP67 switches ...
Submerge at 1 m below the water surface for 30 minutes.

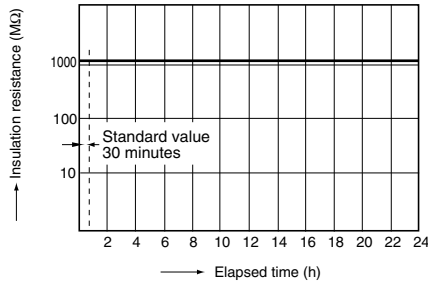

• Hydrogen sulfide exposure test

Test conditions: Concentration: 3 ppm, Temperature: 40°C
104°F, Humidity: 75% RH

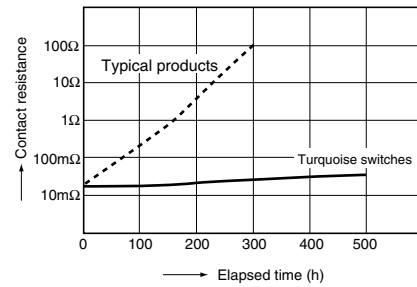

■ Oil-proof and chemical-proof characteristics

The rubber elastomer swells when exposed to oil and chemicals. The extent of swelling will vary widely depending on the type and amount of oil and chemicals.

Check with the actual oil or chemicals used.

In particular, be aware that solvents such as freon, chlorine, and toluene cannot be used.

■ Washability [ABJ (BJ) and ABS (BS)]

Do not clean the switch. Doing so can cause problems. Please contact us if cleaning is necessary.

REFERENCE

■ Dust-protected type

This type of construction prevents dust that is large enough to have an effect on operation from getting inside the unit. This construction is stipulated by protective classes against solid matter in the IEC standards (IEC60529).

The talcum powder used shall be able to pass through a square-meshed sieve the nominal wire diameter of 7 μm . The amount of talcum powder to be used is 2 kg per cubic metre of the test chamber volume. The duration of the test is 8 hours.

No damage observed after the test.

■ Immersion-protected type

This type of construction prevents any harmful effects even after the device is left underwater at a depth of 1 m for 30 minutes.

This construction is stipulated by protective classes against water in the IEC standards (IEC60529).

■ IEC's IP Codes

The IEC (International Electrotechnical Commission) has defined the IP characteristic code that represents the levels of protection described in IEC standard (IEC60529).

The two numbers that follow the IP code (the characteristics numbers) indicate the suitability of this protection for all environmental conditions.

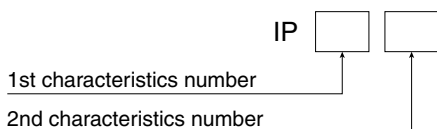

• Level of protection indicated by the 1st Characteristics number

1st Characteristics number	Protection level (IEC60529/Solid matter)
0	No protection
1	Protected against solid matter larger than 50mm
2	Protected against solid matter larger than 12mm
3	Protected against solid matter larger than 2.5mm
4	Protected against solid matter larger than 1.0mm
5	Dust-protected type Prevents dust that is large enough to have an effect on operation from getting inside the unit
6	Dust-resistant type Prevents dust from getting inside the unit

• Level of protection indicated by the 2nd Characteristics number

JIS C0920	2nd Characteristics number	Protection level (IEC60529/Liquid matter)
	0	No protection
Droplet-protected type I	1	Protected against water droplets that fall perpendicular to the unit
Droplet-protected type II	2	Protected against water droplets that fall from within 15° of perpendicular to the unit
Rain-protected type	3	Protected against water droplets that fall from within 60° of perpendicular to the unit
Splash-protected type	4	Protected against water that splashes on the unit from any direction
Spray-protected type	5	Free from adverse effects even if sprayed directly with water from any direction
Water-resistant type	6	Protected against water sprayed directly on the unit from any direction
Immersion-protected type	7	Water does not get inside of the unit when submerged in water according to the specified conditions
Underwater type	8	Unit can be used underwater

Note: Details of test conditions are the same as NECA C 0920. Please refer to them.

Technical Terminology & Cautions for Use

(Snap-action, Detection and Interlock Switches)

TECHNICAL TERMINOLOGY

■ Snap-action switches

A compact switch equipped with an enclosed micro-gap snap-action contact mechanism that makes a specified motion with a specified force to open/close a circuit, and an actuator outside the enclosure (hereinafter referred to as the switch)

■ Actuator

A part of the switch that transmits the received external force to an internal spring mechanism to move the movable contact so that the switch can be opened and closed

■ Actuator stopper

A part of the switch to limit the actuator movement in the switch operation direction

■ Rated values

Values indicating the characteristics and performance guarantee standards of the snap-action switches. The rated current and rated voltage, for instance, assume specific conditions (type of load, current, voltage, frequency, etc.).

■ Mechanical life



The service life when operated at a preset operating frequency without passing electricity through the contacts. (The life test is performed at a switching frequency of 60 times/minute and operating speed of 100 mm/second at the regular cam.)

■ Electrical life

The service life when the rated load is connected to the contact and switching operations are performed. (The life test is performed at a switching frequency of 20 times/minute and operating speed of 100 mm/second at the regular cam.)

■ Contact form

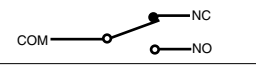
This refers to the components determining the type of application which make up the electrical input/output circuits in the contact.

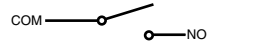
SPDT	
SPST-NC	
SPST-NO	

Terminal symbols

COM: Common terminal

NC: Normally closed terminal

NO: Normally open terminal

■ Insulation resistance

Resistance between non-continuous terminals, each terminal and other exposed metal parts and between each terminal and ground.

■ Dielectric

Threshold limit value that a high voltage can be applied to a predetermined measuring location for one minute without causing damage to the insulation.

■ Contact resistance

This indicates the electrical resistance at the contact part. Generally, this resistance includes the conductor resistance of the spring and terminal portions.

■ Vibration resistance

Malfunction vibration ... Vibration range where a closed contact does not open for longer than a specified time due to vibrations during use of the snap-action switches.

■ Shock resistance

Shock durability ... Shock range where the mechanical shocks received during snap-action switches transport and installation do not damage the parts or harm the operating characteristics. Malfunction shock ... Shock range where a closed contact does not open for longer than a specified time due to shocks during use of the snap-action switches.

OPERATING CHARACTERISTIC

Definition of operating characteristic

The main terminological illustrations and meanings which are used with snap-action switches are as follows.

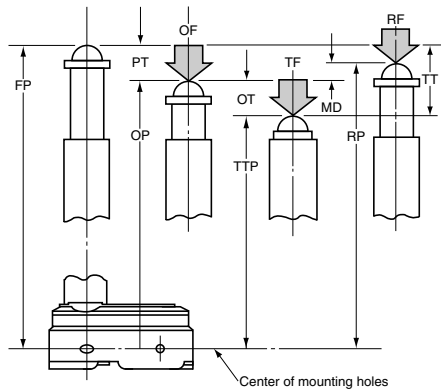

Classification	Terminology	Symbol	Unit	Varying display method	Starting current
Force	Operating Force	OF	N	Max.	The force required to cause contact snap-action. It is expressed in terms of force applied to the actuator.
	Release Force	RF	N	Min.	The force to be applied to the actuator at the moment contact snaps back from operated position to total travel position.
	Total travel Force	TF	N		Force applied to an actuator required to move from an operating position to a total travel position
Movement	Pretravel	PT	mm, degree	Max.	Distance or degree of the actuator movement from free position to operating position.
	Overtravel	OT	mm, degree	Min.	The distance or degree which the actuator is permitted to travel after actuation without any damage to the switching mechanism.
	Movement Differential	MD	mm, degree	Max.	The distance or degree from operating position to release position of the actuator.
	Total travel	TT	mm, degree		The migration length or the move angle from the free position to total travel position of actuator
Position	Free Position	FP	mm, degree		Position of the actuator when no force is applied to.
	Operating Position	OP	mm, degree	±	The position of the actuator when the traveling contacts snaps with the fixed contact.
	Release Position	RP	mm, degree		The position of the actuator when the traveling contact snaps back from operating position to its original position.
	Total travel Position	TTP	mm, degree		The stopping position of the actuator after total travel.

TECHNICAL NOTES ON MECHANICAL CHARACTERISTICS

Actuation Force and Stroke

Adequate stroke setting is the key to high reliability. It is also important that adequate contact force be maintained to ensure high reliability. For a normally closed (NC) circuit, the driving mechanism should be set so that the actuator is normally in the free position. For a normally open (NO) circuit, the actuator should be pressed to 70% to 100% of the specified stroke to absorb possible errors.

If the stroke is set too close to the operating point (OP), this may cause unstable contact, and in the worst case may cause actuator damage due to inertia of the drive mechanism. It is advisable that the stroke be adjusted with the mounting plate or driving mechanism.

The figure at right shows a typical example of activation and contact forces varying with stroke. In the vicinity of the OP and RP, the contact force is diminished, causing chatter and contact bounce immediately before or after reversal. For this reason, use the switch while giving due consideration to this. This also causes the snap action switch to be sensitive to vibration or shock.

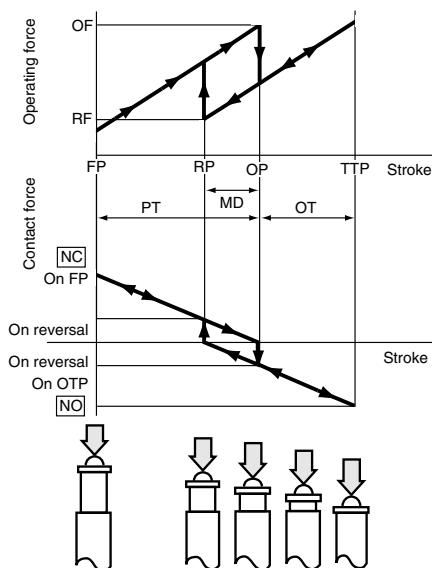

Changes in Operating Characteristics

Exercise design care so that malfunctions will not occur if the operating characteristics vary by as much as 20% from, rated values.

<Example>

In the OF max. 0.98N specification for FS snap-action switches, the allowable max. is $0.98 \text{ N} \times (100\%+20\%) = 1.18 \text{ N}$

In the RF min. 0.15 N min. specification the allowable min. $0.15 \text{ N} \times (100\%-20\%) = 0.12 \text{ N}$

Mechanical Conditions for Type Selection

Actuator type should be selected according to activation method, activation speed, activation rate, and activation frequency.

- 1) An extremely slow activation speed may cause unstable contact transfer, possibly resulting in contact failures or contact fusion.
- 2) An extremely high activation speed may cause damage to contacts or contact response failure.

Driving Mechanism

Use of a driving mechanism which will cause physical impact to the actuator should be avoided.

<Example>

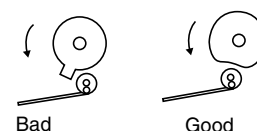

TECHNICAL NOTES ON ELECTRICAL CHARACTERISTICS

1) The snap-action switch is designed for AC operations. While it has small contact gaps and no arc absorber, it may be used for low-capacity DC operations.

Please refer to the rating of each products

2) For applications with very small switching voltage or current, choose the low-level load type (Au contact).

Small current and voltage application range (Au contact)

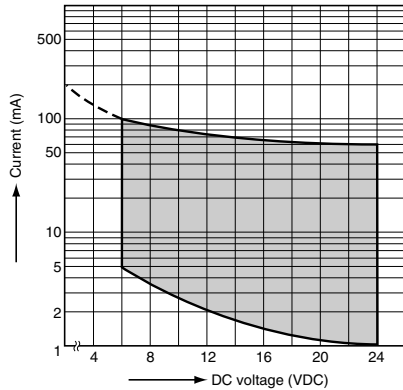

3) When selecting a contact type of a snap-action switch to be used for low-level load switching, the following should be noted. Silver contacts' surfaces are prone to be oxidized and form a sulfide film. The switch operates with no problems at the

beginning of use. However, as the contact surfaces develop films with time, the film may not be broken by the switching operation, causing a conduction failure. Therefore, please choose the Au contact type for switching a load of 0.1 A or below.

4) Application to Electronic Circuits

- The snap-action switch contacts can sustain bounce or chatter when closed. Bounce or chatter can cause noise or pulse count errors when the snap action switch is used in electronic circuits.

- If contact bounce or chatter poses problems in the vicinity of the OP and RP, use a suitable absorption network, such as a C/R network.

5) Check the surge current, normal current and surge duration.

6) Contact resistance given in performance specifications is measured with a voltage drop method using 6 to 8 V DC, 1 A (except for low-level load type). Contact resistance across COM and NC terminals is measured in the free position, while contact resistance across COM and NO terminals is measured in the total travel position.

7) Ratings are measured under the following conditions:

Inductive load: Power factor 0.6 to 0.7

Time constant: 7 ms or less (DC)

8) To prevent contact welding failure, be sure to use a serial resistance for each capacitive load.

9) If snap-action switch operation is synchronized with the AC supply phase, this may cause: shortened electrical life, contact fusion failure, contact transfer, or other reliability problems.

CAUTIONS IN A CIRCUIT

1) Contact protection is recommended when snap-action switches are used in an inductive load circuit.

Circuit diagram	Cautions for use
	(1) $r =$ more than 10Ω (2) In an AC circuit Impedance of R is to be slightly smaller than impedance of r and c.
	Can be used for both AC and DC. Impedance of r is nearly equal to impedance of R. C: $0.1 \mu\text{F}$
	(1) For DC circuits only.
	Can be used for both AC and DC.

2) Do not connect the contacts on individual switches to different type or different poles of the power supply. Examples of power supply connections (connection to different poles)

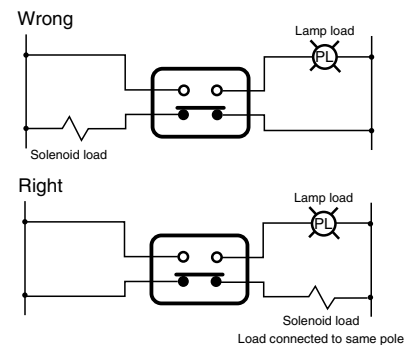

Example of wrong power supply connection (connection to different poles of power supply)
 This may lead to mixed DC and AC.

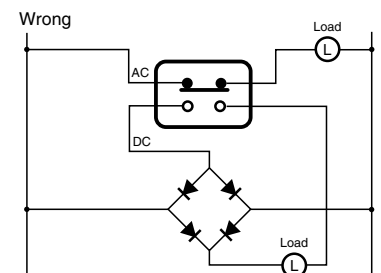

3) Avoid circuits which apply voltage between contacts. (This may lead to mixed deposition.)

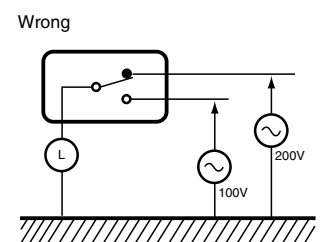

MOUNTING STATE AND ENVIRONMENT

■ Checking the insulation distance

After mounting and wiring, check the insulation distance between terminals and the ground. If the insulation distance is inadequate, mount insulating material between as required.

■ Fastening the snap-action switch body

See the Section "CAUTIONS FOR USE" for the individual switch.

■ Position adjustment with effector

- 1) The effector should be positioned so that direct force is not applied to the plunger or actuator in its free position. The operating force to the plunger should only be applied in a perpendicular direction.
- 2) Note that the use of the switch as a stopper may cause an operational problem.

■ Switch installation position

- Basically, the switch should be installed so that the object to press the switch's plunger or lever can press it down to 70 to 100% of OT of the switch. When determining the position, the tolerance of OP (Operating Position) and other factors should be taken into account.

The following describes the case where the strictest tolerance conditions are adopted.

- Example: Hinge lever type FS switch

Reference values: OP = 8.8 ± 0.8 mm
 PT = max. 2.8mm
 OT = min. 1.2mm

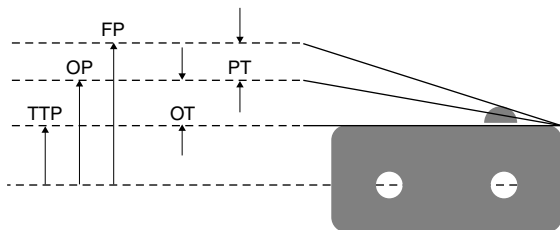

- (1) When the switch is not pressed
 The object to press the lever should not be in contact with the lever.
 For this purpose, the object should be at a distance from the switch fater than the maximum FP (Free Position) value.
 $FP \text{ max} = OP \text{ max} + PT \text{ max} = 9.6 + 2.8 = 12.4 \text{ mm max}$
 The object should be at a distance of 12.4 mm or more from the mounting hole.
- (2) Depressed position
 The plunger/lever should be pressed down to 70% or more of OT (Over Travel). Therefore, the depressed position should be calculated based on the minimum value of OP (Operating Position) and the 70 and 100% of the OT value.
 $OP \text{ min} - 70\% \text{ of OT} = 8.0 - 0.84 = 7.16 \text{ mm}$
 $OP \text{ min} - 100\% \text{ of OT} = 8.0 - 1.2 = 6.80 \text{ mm}$
 The plunger/lever should be pressed down to the position of 6.80 to 7.16 mm from the mounting hole.

■ Soldering precautions

For manual soldering, lay the terminals flat (horizontal with the ground) and quickly perform the soldering operation using a soldering iron with the appropriate heat capacity and the proper amount of solder. Take care that the flux does not flow into the switch interior by using a ventilation fan to discharge flux gas and to prevent contact of the switch body with the soldering iron tip.

Be careful not to apply force to the lead wires or the terminal portions immediately after soldering.

The temperature setting and time conditions vary depending on the product.

See the section "CAUTIONS FOR USE" for each product.

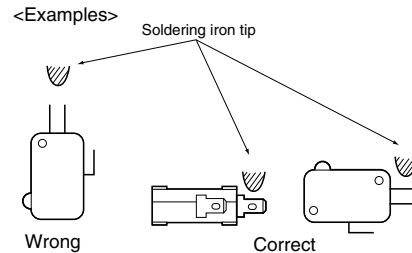

■ Avoid using in a silicon atmosphere

Avoid using organic silicon rubber, adhesives, sealing compounds, oil, grease, and wires in a silicon atmosphere.

■ Please consult us when using under the following conditions*:

- 1) Environments where hydrogen sulfide or other corrosive gases are present.
- 2) Environments where gasoline, thinner or other flammable, explosive gases are present.
- 3) Dusty environments (for non-seal type snap action switches).
- 4) The perpendicular operating speed exceeds the allowable operating speed.
- 5) Switching between different poles.
- 6) Use in environments not in the prescribed temperature or humidity range.

■ Storage precautions

To prevent discoloration due to sulfurization of the terminals (silver-plated), store the switches in a polyethylene bag or other suitable airtight container.

■ Usage, storage, and transport conditions

During usage, storage, or transportation, avoid locations subject to direct sunlight and maintain normal temperature, humidity, and pressure conditions.

The allowable specifications for environments suitable for usage, storage, and transportation are given below.

1) Temperature: The allowable temperature range differs for each switch, so refer to the switch's individual specifications. In addition, when transporting or storing switches while they are tube packaged, there are cases when the temperature may differ from the allowable range. In this situation, be sure to consult the individual specifications.

2) Humidity: 5 to 85% R.H.

3) Pressure: 86 to 106 kPa

The humidity range varies with the temperature. Use within the range indicated in the graph below.

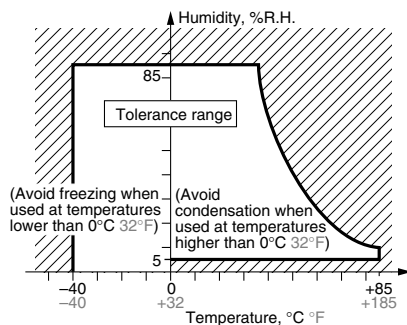

(The allowable temperature depends on the switch.)

- Condensation will occur inside the switch if there is a sudden change in ambient temperature when used in an atmosphere of high temperature and high humidity. This is particularly likely to happen when being transported by ship, so please be careful of the atmosphere when shipping. Condensation is the phenomenon whereby steam condenses to cause water droplets that adhere to the switch when an atmosphere of high temperature and humidity rapidly changes from a high to low temperature or when the switch is quickly moved from a low humidity location to one of high temperature and humidity. Please be careful because condensation can cause adverse conditions such as deterioration of insulation, coil cutoff, and rust.
- Condensation or other moisture may freeze on the switch when the temperatures is lower than 0°C 32°F. This causes problems such as sticking of movable parts or operational time lags.
- The plastic becomes brittle if the switch is exposed to a low temperature, low humidity environment for long periods of time.
- Storage for extended periods of time (including transportation periods) at high temperatures or high humidity levels or in atmospheres with organic gases or sulfide gases may cause a sulfide film or oxide film to form on the surfaces of the contacts and/or it may interfere with the functions. Check out the atmosphere in which the units are to be stored and transported.
- In terms of the packing format used, make every effort to keep the effects of moisture, organic gases and sulfide gases to the absolute minimum.

■ We reserve the right to modify without notice the materials, internal components, and other parts to improve product quality.

■ Handling precautions

When handling the switches, be careful not to drop them on the floor since this may damage them.

* Select contact sulfurization (clipping) prevention products (FS and Au-clad double layer contacts) for use with extremely small loads or an environment-resistant Turquoise switch.















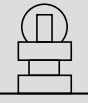

■ Others

1) Failure modes of switches include short-circuiting, open-circuiting and temperature rises. If this switch is to be used in equipment where safety is a prime consideration, examine the possible effects of these failures on the equipment concerned, and ensure safety by providing protection circuits or protection devices. In terms of the systems involved, make provision for redundancy in the design and take steps to achieve safety design.

2) The ambient operating temperature (and humidity) range quoted is the range in which the switch can be operated on a continuous basis: it does not mean that using the switch within the rating guarantees the durability performance and environment withstanding performance of the switch. For details on the performance guarantee, check the specifications of each product concerned.

Technical Terminology & Cautions for Use

■ Types of actuators

Shape	Classification	Pretravel (PT)	Overtravel (OT)	Operating Force (OF)	Vibration Shock	Features	
	Pin plunger	Small	Small	Large	Out-standing	Appropriate for linear short-stroke action. Pin plunger acts directly on snap action mechanism, enabling high-precision positioning. Amount of movement after operation is smallest among all of the actuators, however, so reliable stopper is required.	
	Spring small plunger	Small	Medium	Large	Excellent	Used in much the same way as the pin plunger, but is easier to use because the amount of movement after operation is larger.	
	Spring short plunger	Small	Medium	Large	Good	Pin plunger is short, with large plunger diameter that makes centering easier. Like small spring plunger, amount of movement after operation is large.	
	Panel attachment plunger	Small	Large	Large	Good	Secured to panel with hex or lock nut; used as manual or mechanical plunger. Amount of movement after operation is extremely large and operation point can be adjusted by changing attachment position. Can be used in combination with low-speed cam.	
	Panel attachment roller plunger	Small	Large	Large	Possible	This is the panel attachment type with a roller, and can be used with fast-moving cams and dogs..	
	Hinge lever	Large	Medium	Small	Possible	Little force required for operation. Appropriate for use with low-speed cams and dogs; has large stroke. Lever available in various shapes to fit operating unit.	
	Simulated roller lever	Large	Medium	Small	Possible	Tip of hinge lever is bent into a semi-circle, enabling use as a simple roller type.	
	Leaf lever	Large	Large	Small	Excellent	Play in lever is used to assure maximum stroke. Construction provides for space where lever is attached, for outstanding resistance to freezing.	
	Hinge roller lever	Large	Medium	Small	Possible	This is a hinge lever with a roller, and can be used with high-speed cams and dogs. The force required for pin plunger action is lighter than that of the lever, and the stroke is longer.	
	One way action hinge roller lever	Medium	Medium	Medium	Possible	This is hinge roller lever type, and can operate in relation to an operating unit from a one way direction, but the roller is bent from the opposite direction and cannot move. This can be used to prevent reverse-direction action.	
	Leaf spring	Medium	Medium	Medium	Good	This has a leaf spring with offset yield force and has a large stroke. Ideal for driving low-speed cams and cylinders. Fulcrum is fixed for high precision. To prevent leaf damage, movement after operation must be within specified value.	
	Roller leaf spring	Medium	Medium	Medium	Good	This is a leaf spring with a roller, and can be used with high-speed cams.	
	(OC reversed action groove type) Reverse-action hinge lever	Large	Small	Medium	Excellent	This is used for low-speed, low-torque cams. The lever comes in various shapes to fit the operating body.	The plunger is constantly pressed down by a coiled spring, and operating the lever induces reverse action. Because the plunger is depressed when not engaged, vibration and shock resistance are excellent. Pressing the plunger too far does not cause abnormal force to be applied to the switch mechanism, so a stable service life is assured.
	(OC reversed action groove type) Reverse-action hinge roller lever	Medium	Medium	Medium	Excellent	This is a reverse-action hinge lever with a roller and is appropriate for cam operation. Excellent resistance to vibration and impact when not engaged.	
	(OC reversed action groove type) Reverse-action hinge roller short lever	Small	Medium	Large	Excellent	This is a shorter version of the reverse-action hinge lever with a roller and has a larger action force, but is appropriate for cam operation with a short stroke. Excellent resistance to vibration and impact when not engaged.	
	Rotating-action type	Large	Large	Small	Possible	This is a rotating, light-action type that is ideal for detecting paper, coins, and similar objects.	

X-ON Electronics

Largest Supplier of Electrical and Electronic Components

Click to view similar products for [Basic / Snap Action Switches](#) category:

Click to view products by [Panasonic](#) manufacturer:

Other Similar products are found below :

[83228001](#) [01.098.1358.1](#) [602EN1-6B](#) [602EN532](#) [602EN535-RB](#) [602HE5-RB1](#) [604HE162](#) [604HE223-6B](#) [624HE17-RB](#) [6HM89](#) [6PA78-JM](#)
[6SE1](#) [6SX1-H58](#) [70500840](#) [MBD5B1](#) [MBH2731](#) [73-316-0012](#) [79211759](#) [79211923](#) [79218589](#) [7AS12](#) [ML-1155](#) [ML-1376](#) [831010C3.0](#)
[831060C3.TL](#) [831090C2.EL](#) [83131904](#) [84212012](#) [8AS239](#) [8HM73-3](#) [903VB1-PG](#) [914CE1-6G](#) [PL-100](#) [11SM1077-H4](#) [11SM1077-H58](#)
[11SM1-TN107](#) [11SM405](#) [11SM703-T](#) [11SM8423-H2](#) [11SX37-T](#) [11SX48-H58](#) [11SX55-H58](#) [11SM2442-T](#) [11SM76-T](#) [11SM77-H58](#)
[11SM77-T](#) [11SM863-T](#) [11SM866](#) [11SX47-H58](#) [A7CN-1M-1-LEFT](#)