

## Pressure Sensor PS/PF



High precision pressure sensor (without amp.)

### Features

- Compact size (PS type)
- High accuracy and liner characteristic
- Broad line-up
- RoHS compliant

### Typical Applications

- Industrial use: pressure switches and pneumatic components, compressed air pressure measuring devices and airbeds
- Medical use: blood pressure meters, oxygen generator and airbeds
- Others: pressure sensing devices for air pressure mediums

### Ordering Information

#### ADP

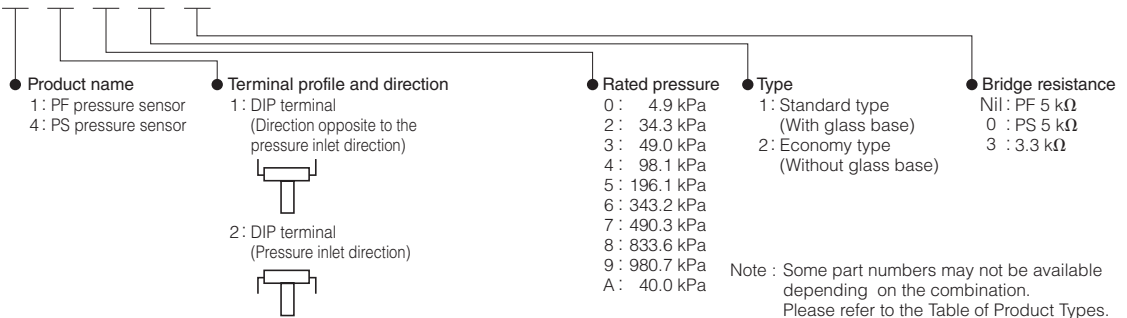

### Types

Brige resistance		Part No.										
		PS pressure sensor					PF pressure sensor					
		5 kΩ		3.3 kΩ			5 kΩ		3.3 kΩ			
Pressure	Terminal											
		DIP terminal: Direction opposite to the pressure inlet direction	DIP terminal: Pressure inlet direction	SMD terminal	DIP terminal: Direction opposite to the pressure inlet direction	DIP terminal: Pressure inlet direction	DIP terminal: Direction opposite to the pressure inlet direction	DIP terminal: Pressure inlet direction	DIP terminal: Direction opposite to the pressure inlet direction	DIP terminal: Pressure inlet direction	DIP terminal: Direction opposite to the pressure inlet direction	DIP terminal: Pressure inlet direction
Standard type (with glass base)	4.9kPa	ADP41010	ADP42010	—	—	—	ADP1101	ADP1201	—	—	—	
	34.3kPa	ADP41210	ADP42210	—	—	—	ADP1121	ADP1221	—	—	—	
	49.0kPa	ADP41310	ADP42310	—	—	—	ADP1131	ADP1231	—	—	—	
	98.1kPa	ADP41410	ADP42410	ADP4932	ADP41413	ADP42413	ADP1141	ADP1241	—	—	—	
	196.1kPa	ADP41510	ADP42510	—	—	—	ADP1151	ADP1251	—	—	—	
	343.2kPa	ADP41610	ADP42610	—	—	—	ADP1161	ADP1261	—	—	—	
	490.3kPa	ADP41710	ADP42710	—	—	—	ADP1171	ADP1271	—	—	—	
	833.6kPa	ADP41810	ADP42810	—	—	—	ADP1181	ADP1281	—	—	—	
Economy type (without glass base)	40.0kPa	ADP41910	ADP42910	ADP4933	ADP41913	ADP42913	ADP1191	ADP1291	—	—	ADP11A23	ADP12A23

Standard packing : Carton : 100 pcs.; Case : 1,000 pcs.

## Rating

Type	Standard type (With glass base)						Economy type (Without glass base)	
Type of pressure	Gauge pressure							
Pressure medium	Air *2							
Rated pressure (Unit: kPa)	4.9	34.3 to 343.2	490.3	833.6	980.7	98.1 *3	980.7 *3	40.0
Max. applied pressure	Twice of the rated pressure			1.5 times of the rated pressure		Twice of the rated pressure	1.5 times of the rated pressure	Twice of the rated pressure
Bridge resistance	5,000 Ω ±1,000 Ω					3,300 Ω ±700 Ω		3,300 Ω ±600 Ω
Ambient temperature	-20 °C to +100 °C -4 °F to +212 °F (no freezing or condensation)							-5 °C to +50 °C 23 °F to +122 °F
Storage temperature	-40 °C to +120 °C -40 °F to +248 °F (no freezing or condensation)							-20 °C to +70 °C -4 °F to +158 °F
Standard temperature	25 °C 77 °F					30 °C 86 °F		25 °C 77 °F
Temperature compensation range	0 °C to 50 °C 32 °F to +122 °F					0 °C to 60 °C 32 °F to +140 °F		5 °C to 45 °C 41 °F to +113 °F
Drive current (constant current)	1.5 mA.DC					1.0 mA.DC		1.5 mA.DC
Output span voltage	40±20 mV	100±40 mV				65±25 mV		43.5±22.5 mV
Offset voltage	±20 mV							±15 mV
Linearity	±0.7 %FS	±0.3 %FS	±0.5 %FS	±0.6 %FS		±1.0 %FS		±0.3 %FS
Pressure hysteresis	±0.6 %FS	±0.2 %FS	±0.4 %FS			±1.0 %FS		±0.7 %FS
Offset voltage-temperature characteristics *4	±15 %FS	±5.0 %FS				±3.5 %FS		±10 %FS
Sensitivity-temperature characteristics *4	±10 %FS	±2.5 %FS					±1.3 %FS	

Notes : \*1 Unless otherwise specified, measurements were taken with a drive current of ±0.01 mA.DC and humidity ranging from 25% to 85%.

\*2 Please consult us if a pressure medium other than air is to be used.

\*3 For PS pressure sensor only

\*4 This is the regulation which applies within the compensation temperature range.

\*5 Please consult us if the intended use involves a negative pressure.

## Reference Data

### [PS pressure sensor]

#### ● Characteristics data

##### 1.-(1) Output characteristics

ADP41913

Drive current : 1.0 mA.DC ; temperature : 30 °C 86 °F

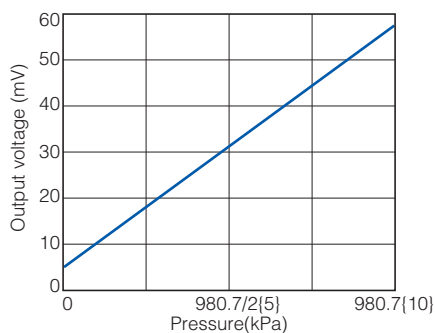

##### 1.-(2) Offset voltage - temperature characteristics

ADP41913

Drive current : 1.0 mA.DC; rating ±3.5 %FS

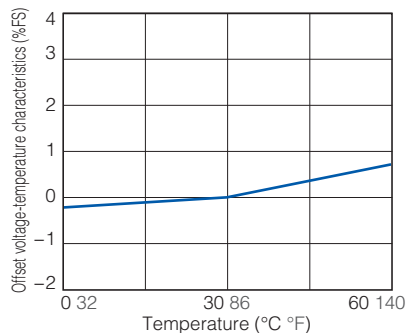

##### 1.-(3) Sensitivity -temperature characteristics

ADP41913

Drive current : 1.0 mA.DC; rating ±2.5 %FS

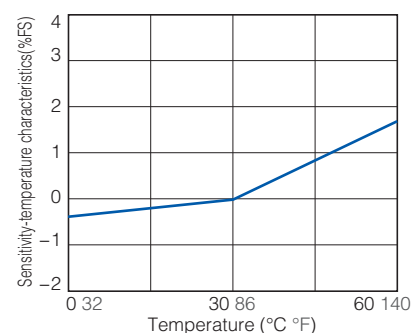

#### ● Pressure cycle range (0 to rated pressure)

Tested sample : ADP41913, temperature : 100 °C 212 °F, No. of cycle: 1×10<sup>6</sup>

Offset voltage range

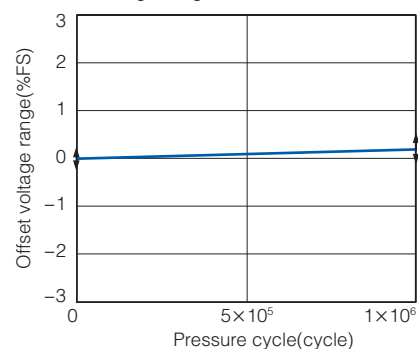

Output span voltage range

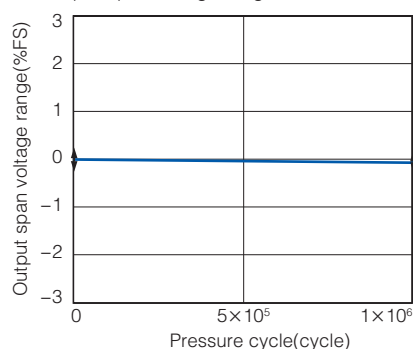

Even after testing for 1 million times, the variations in the offset voltage and output span voltage are minimal.

## [PF pressure sensor]

### ● Characteristics data

#### 1.-(1) Output characteristics

ADP1141

Drive current : 1.5 mA.DC; temperature : 30 °C 86 °F

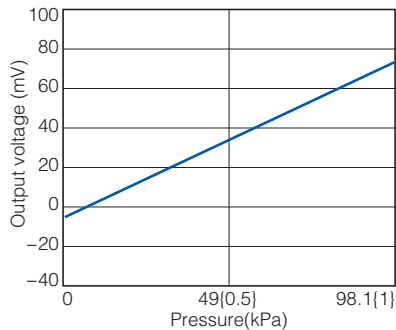

#### 1.-(2) Offset voltage - temperature characteristics

ADP1141

Drive current : 1.5 mA.DC; rating  $\pm 5$  %FS

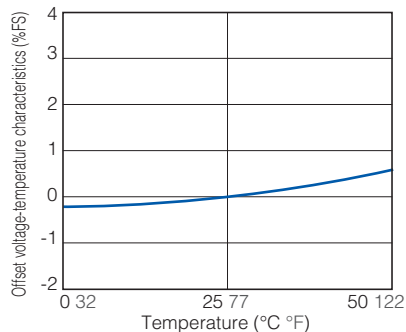

#### 1.-(2) Sensitivity - temperature characteristics

ADP1141

Drive current : 1.5 mA.DC; rating  $\pm 2.5$  %FS

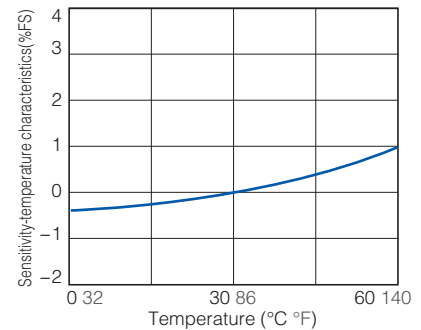

### ● Pressure cycle range (0 to rated pressure)

Tested sample : ADP1131, temperature : 25 °C 77 °F

#### Offset voltage range

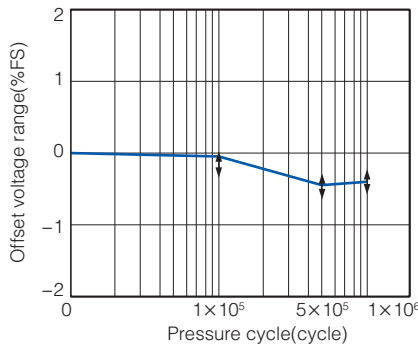

#### Output span voltage range

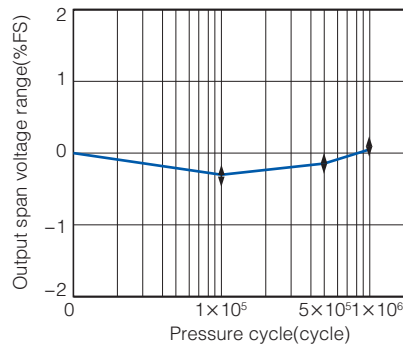

Even after testing for 1 million times, the variations in the offset voltage and output span voltage are minimal.

## Evaluation Test

Classification	Tested item	Tested condition	Result
Environmental characteristics	Storage at high temperature	Temperature : Left in a 120 °C 248 °F constant temperature bath Time : 1,000 hrs.	Passed
	Storage at low temperature	Temperature : Left in a -40 °C -40 °F constant temperature bath Time : 1,000 hrs.	Passed
	Humidity	Temperature/humidity : Left at 40 °C 104 °F, 90 % RH Time : 1,000 hrs.	Passed
	Temperature cycle	Temperature : -40 °C to 120 °C -40 °F to 248 °F 1 cycle : 30 Min. Times of cycle : 100	Passed
Endurance characteristics	High temperature/ high humidity operation	Temperature/humidity : 40°C 104 °F, 90% RH Operation times : 10 <sup>6</sup> , rated voltage applied.	Passed
Mechanical characteristics	Vibration resistance	Double amplitude : 1.5 mm 0.059 inch Vibration : 10 to 55 Hz Applied vibration direction : X, Y, Z 3 directions Times : 2 hrs each	Passed
	Dropping resistance	Dropping height : 75 cm 29.528 inch Times : 2 times	Passed
	Terminal strength	Pulling strength : 9.8 N {1 kgf}, 10 sec. Bending strength : 4.9 N {0.5 kgf}, left and right 90 ° 1 time	Passed
Soldering resistance	Soldered in DIP soldering bath	Temperature : 230 °C 446 °F Time : 5 sec.	Passed
	Temperature	Temperature : 260°C 500 °F Time : 10 sec.	Passed

Note: For details other than listed above, please consult us.

Items	Criteria
Offset voltage Output span voltage	Variation amount within $\pm 5.0$ %FS of value

## Dimensions

The CAD data of the products with a **CAD Data** mark can be downloaded from: <http://industrial.panasonic.com/>

### [PS pressure sensor]

- Terminal direction : DIP terminal Direction opposite to the pressure inlet direction ADP41□□□

#### CAD Data

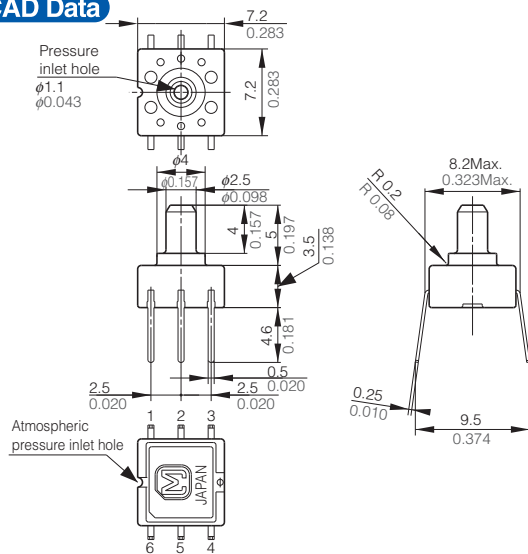

#### Recommended PC board pattern (BOTTOM VIEW)

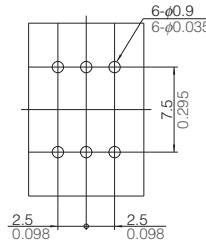

#### Terminal connection diagram

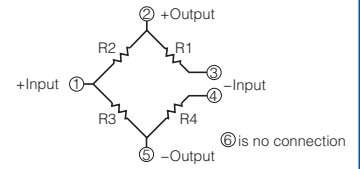

Terminal No.	Name
1	Power supply (+)
2	Output (+)
3	Power supply (-)
4	Power supply (-)
5	Output (-)
6	No connection

Note: Leave terminal 6 unconnected.

unit : mm inch  
General tolerance : ±0.3 ±0.012

- Terminal direction : DIP terminal Pressure inlet direction ADP42□□□

#### CAD Data

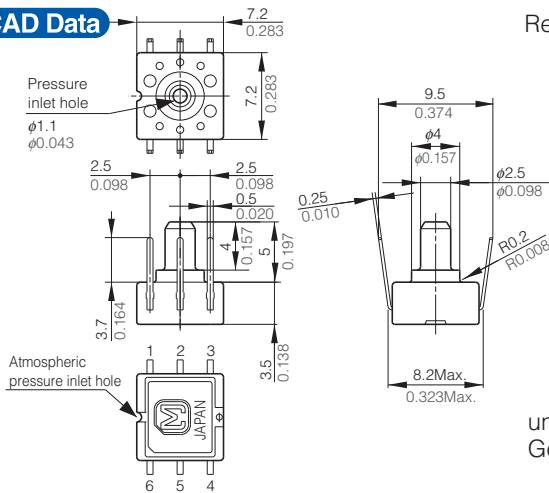

#### Recommended PC board pattern (BOTTOM VIEW)

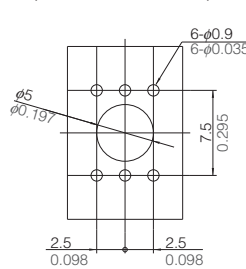

#### Terminal connection diagram

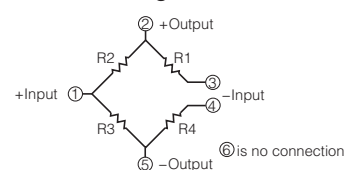

Terminal No.	Name
1	Power supply (+)
2	Output (+)
3	Power supply (-)
4	Power supply (-)
5	Output (-)
6	No connection

Note: Leave terminal 6 unconnected.

unit : mm inch  
General tolerance : ±0.3 ±0.012

- Terminal direction : SMD terminal ADP4932, ADP4933

#### CAD Data

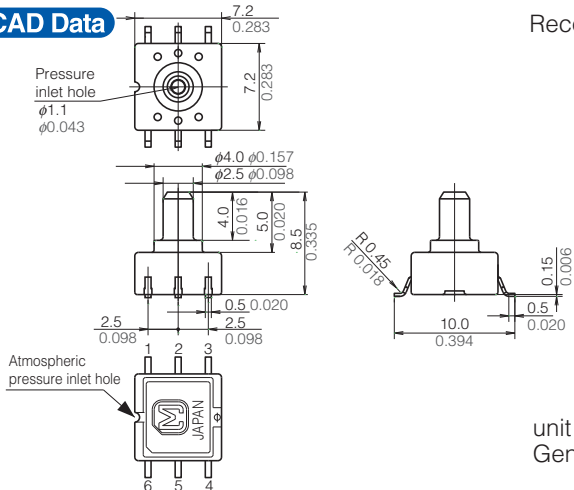

#### Recommended PC board pattern (BOTTOM VIEW)

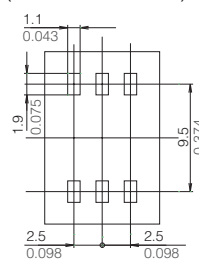

#### Terminal connection diagram

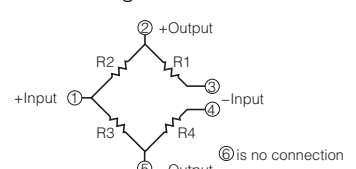

Terminal No.	Name
1	Power supply (+)
2	Output (+)
3	Power supply (-)
4	Power supply (-)
5	Output (-)
6	No connection

Note: Leave terminal 6 unconnected.

unit : mm inch  
General tolerance : ±0.3 ±0.012

## Dimensions

The CAD data of the products with a **CAD Data** mark can be downloaded from: <http://industrial.panasonic.com/>

### [PF pressure sensor]

- Terminal direction : DIP terminal Direction opposite to the pressure inlet direction ADP11□□(□)

#### CAD Data

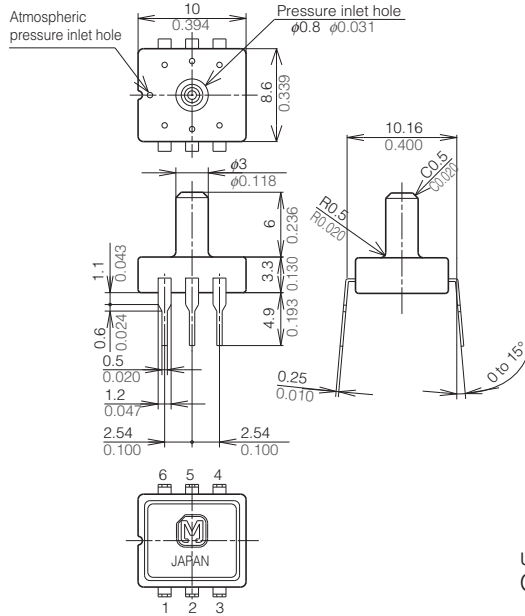

Recommended PC board pattern (BOTTOM VIEW)

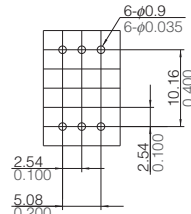

Tolerance : ±0.1

unit : mm inch  
General tolerance : ±0.3 ±0.012

Terminal connection diagram

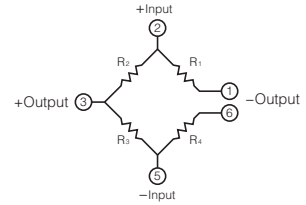

Terminal No.	Name
1	Output (-)
2	Power supply (+)
3	Output (+)
4	No connection
5	Power supply (-)
6	Output (-)

Note: Leave terminal 4 unconnected.

- Terminal direction : DIP terminal Pressure inlet direction ADP12□□(□)

#### CAD Data

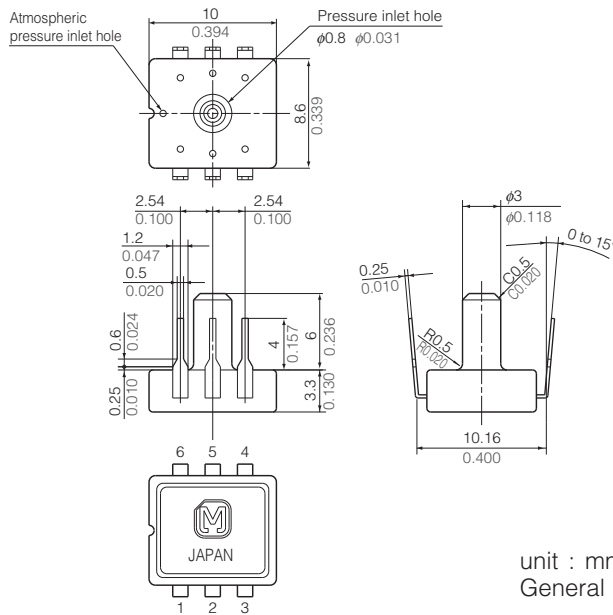

Recommended PC board pattern (BOTTOM VIEW)

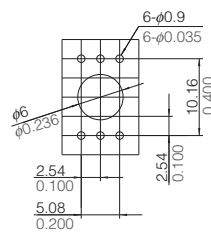

Tolerance : ±0.1

unit : mm inch  
General tolerance : ±0.3 ±0.012

Terminal connection diagram

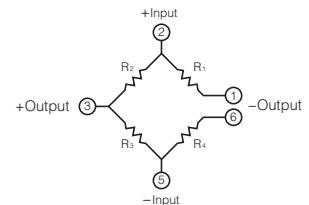

Terminal No.	Name
1	Power supply (+)
2	Output (+)
3	Power supply (-)
4	Power supply (-)
5	Output (-)
6	No connection

Note: Leave terminal 4 unconnected.

## NOTES

### ■ Mounting

Use the land of the printed-circuit board on which the sensor is securely fixed.

### ■ Soldering

Avoid the external thermal influence as the product has a limited thermal capacity due to its compact structure. Heat deformation may damage the sensor or deteriorate its performance. Use the non-corrosive rosin flux. Prevent the flux from entering into the inside of the product as the sensor is exposed to the atmosphere.

- 1) Manual soldering
  - Raise the temperature of the soldering tip between 260 and 300 °C 500 and 572 °F (30 W) and solder within 5 seconds.
  - The sensor output may vary if the load is applied on the terminal during soldering.
  - Keep the soldering tip clean.
- 2) DIP soldering (DIP Terminal)
  - Keep the temperature of the DIP solder tank below 260 °C 500 °F and solder within 5 seconds.
  - To avoid heat deformation, do not perform DIP soldering when mounting on the circuit board which has a small thermal capacity.
- 3) Reflow soldering (SMD Terminal)
  - The recommended reflow temperature profile conditions are given below.

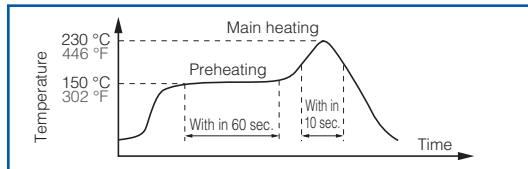

- We recommend the screen solder printing method as the method of cream.
  - Please refer to the recommended PC board specification diagram for the PC board foot pattern.
  - Self alignment may not always work as expected, therefore, please carefully the position of the terminals and pattern.
  - The temperature of the profile is assumed to be a value measured with the printed wiring board of the terminal neighborhood.
  - Please evaluate solderability under the actual mounting conditions since welding and deformation of the pressure inlet port may occur due to heat stress depending on equipments or conditions.
- 4) Rework soldering
    - Complete rework at a time.
    - Use a flattened soldering tip when performing rework on the solder bridge. Do not add the flux.
    - Keep the soldering tip below the temperature described in the specifications.
  - 5) Avoid drop and rough handling as excessive force may deform the terminal and damage soldering characteristics.
  - 6) Keep the circuit board warpage within 0.05 mm of the full width of the sensor.
  - 7) After soldering, do not apply stress on the soldered part when cutting or bending the circuit board.
  - 8) Prevent human hands or metal pieces from contacting with the sensor terminal.  
Such contact may cause anomalous outlets as the terminal is exposed to the atmosphere.

- 9) After soldering, prevent chemical agents from adhering to the sensor when applying coating to avoid insulation deterioration of the circuit board.
- 10) Please consult us concerning leadfree soldering.

### ■ Cleaning

- Prevent cleaning liquid from entering the inside of the product as the sensor is exposed to the atmosphere.
- Do not perform ultrasonic cleaning in order to prevent damages to the product.

### ■ Environment

- 1) Avoid use and storage in the corrosive gas (organic solvent, sulfurous acid and hydrogen sulfide gases) which negatively affects the product.
- 2) Avoid use in a place where these products come in contact with water as the sensor does not have a splash-proof construction.
- 3) Avoid use in an environment where these products cause dew condensation.  
When water attached to the sensor chip freezes, the sensor output may be fluctuated or damaged.
- 4) Due to the structure of the pressure sensor chip, the output varies under light.  
Do not expose the sensor chip to light when applying a voltage by using a transparent tube.
- 5) Do not apply high-frequency oscillation, such as ultrasonic waves, to the product.

### ■ Quality check under actual use conditions

These specifications are for individual components. Before use, carefully check the performance and quality under actual use conditions to enhance stability.

### ■ Other precautions

- 1) The wrong mounting method and the pressure range may invite the risk of accidents.
- 2) Only applicable pressure medium is dry air. Avoid use in the corrosive gas (organic solvent, sulfurous acid and hydrogen sulfide gases) or other mediums containing moisture or foreign substances. Such mediums may damage or break the product.
- 3) The pressure sensor chip is located inside the pressure introduction port. Do not insert foreign substances, such as wires, into the port as those substances may damage the chip and close the port. Do not block the atmosphere introduction port.
- 4) Use electric power within the rated power range. Use beyond the range may damage the product.
- 5) Follow below instructions as static electricity may damage the product:
  - (1) For Storage, short the circuit between terminals by using conductive substances or wrap the whole chip with aluminum foil. For storage and transportation, avoid plastic containers which are easily electrified.
  - (2) Before use, connect electrified materials on desk and operators to the ground in order to safely discharge static electricity.
- 6) Carefully select and fix tubes, introduction pipes and products based on the working voltage. Please contact us for any inquiries.

## APPLICATION CIRCUIT DIAGRAM (EXAMPLE)

The pressure sensor converts a voltage by constant current drive and if necessary, amplifies the voltage. The circuit on the right is a typical use example.

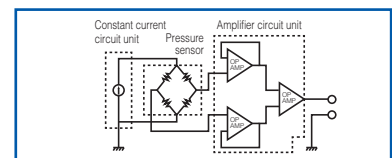

## MOUNTING METHOD

The general method of air pressure transmission varies depending on the low/high pressure condition.

### • Usage note

- (1) Select a study pressure introduction pipe to avoid pressure leak.
- (2) Securely fix the pressure introduction pipe to avoid pressure leak.
- (3) Do not block the pressure introduction pipe.

### Methods of transmitting air pressures

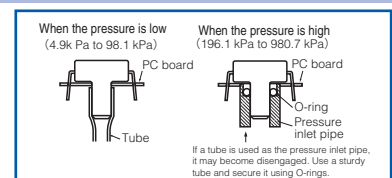

## X-ON Electronics

Largest Supplier of Electrical and Electronic Components

*Click to view similar products for [Board Mount Pressure Sensors](#) category:*

*Click to view products by [Panasonic](#) manufacturer:*

Other Similar products are found below :

[80527-25.0H2-05](#) [80541-B00000150-01](#) [80541-B00000200-05](#) [80554-00700100-05](#) [80568-00300050-01](#) [81618-B00000040-01](#) [81739-B00000900-01](#) [81807-B00000020-01](#) [81808-B00000150-14](#) [82903-B00000020-01](#) [93.631.4253.0](#) [93.731.4353.0](#) [93.932.4553.0](#) [136PC150G2](#) [136PC15A1](#) [142PC95AW71](#) [142PC05DW70](#) [MPXV2202DPT1](#) [15PSI-G-4V](#) [1805-01A-L0N-B](#) [2000317-1](#) [26PCBKT](#) [26PCCFA6D26](#) [26PCCFS2G](#) [26PCCVA6D](#) [93.632.7353.0](#) [93.731.3653.0](#) [93.931.4853.0](#) [93.932.4853.0](#) [SCDA120-XSC05DC](#) [SP370-23-156-0](#) [185PC30DH](#) [192992-0059](#) [20INCH-G-MV-MINI](#) [26PCAFJ3G](#) [26PCAFS2G54](#) [26PCCEP5G24](#) [26PCJEU5G19](#) [30INCH-D1-MV-MINI](#) [ASCX15AN-90](#) [TSCSAAN001PDUCV](#) [DCAL401DN](#) [DCAL401GN](#) [XZ202798SSC](#) [XZ203676HSC](#) [SP370-25-116-0](#) [81717-00000050-05](#) [81794-B00001200-01](#) [HSCDLNN100PGAA5](#) [81618-B00000040-05](#)