

**High Sensitivity, with 100mW nominal operating power, in a compact and space saving case**

## GN RELAYS (AGN)

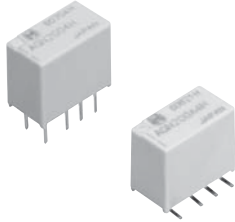

### FEATURES

- 1. Compact slim body saves space.**  
Thanks to the small surface area of 5.7 mm × 10.6 mm .224 inch × .417 inch and low height of 9.0 mm .354 inch, the packaging density can be increased to allow for much smaller designs.
- 2. High sensitivity single side stable type (Nominal operating power: 100mW) is available.**
- 3. Outstanding surge resistance**  
Surge breakdown voltage between contacts and coil:  
2,500 V 2×10 μs (Telcordia)  
Surge breakdown voltage between open contacts:  
1,500 V 10×160 μs (FCC part 68)
- 4. The use of twin crossbar contacts ensures high contact reliability.**  
AgPd contact is used because of its good sulfide resistance. Adopting low-gas molding material. Coil assembly molding technology which avoids generating volatile gas from coil.
- 5. Increased packaging density**  
Due to highly efficient magnetic circuit design, leakage flux is reduced and changes in electrical characteristics from components being mounted

close-together are minimized. This all means a packaging density higher than ever before.

- 6. Nominal operating power: 140 mW**
- 7. Outstanding vibration and shock resistance**  
Functional shock resistance: 750 m/s<sup>2</sup>  
Destructive shock resistance: 1,000 m/s<sup>2</sup>  
Functional vibration resistance: 10 to 55 Hz (at double amplitude of 3.3 mm .130 inch)  
Destructive vibration resistance: 10 to 55 Hz (at double amplitude of 5 mm .197 inch)
- 8. Sealed construction allows automatic washing.**

### TYPICAL APPLICATIONS

1. Telephone switchboard
2. Telecommunications equipment
3. Securits equipmeny
4. Test and measurement equipment
5. Electronic consumer and audio visual equipment

### ORDERING INFORMATION

|                           |   |   |  |   |  |  |  |  |
|---------------------------|---|---|--|---|--|--|--|--|
|                           | AGN   | 2 |  | 0 |  |  |  |  |
| Contact arrangement       | 2: 2 Form C   |   |  |   |  |  |  |  |
| Operating function        | 0: Single side stable<br>1: 1 coil latching<br>6: High sensitivity single side stable type  |   |  |   |  |  |  |  |
| Type of operation         | 0: Standard type (B.B.M.)   |   |  |   |  |  |  |  |
| Terminal shape            | Nil: Standard PC board terminal<br>A: Surface-mount terminal A type<br>S: Surface-mount terminal S type                                 |   |  |   |  |  |  |  |
| Nominal coil voltage (DC) | 1H: 1.5V 03: 3V 4H: 4.5V 06: 6V 09: 9V<br>12: 12V 24: 24V   |   |  |   |  |  |  |  |
| Packing style             | Nil: Tube packing<br>X: Tape and reel packing (picked from 1/2/3/4 pin side)<br>Z: Tape and reel packing (picked from 5/6/7/8 pin side) |   |  |   |  |  |  |  |

# GN (AGN)

## TYPES

### 1. Standard PC board terminal

| Nominal coil voltage | Single side stable | 1 coil latching | High sensitivity single side stable |
|----------------------|--------------------|-----------------|-------------------------------------|
|                      | Part No.           | Part No.        | Part No.                            |
| 1.5V DC              | AGN2001H           | AGN2101H        | AGN2601H                            |
| 3V DC                | AGN20003           | AGN21003        | AGN26003                            |
| 4.5V DC              | AGN2004H           | AGN2104H        | AGN2604H                            |
| 6V DC                | AGN20006           | AGN21006        | AGN26006                            |
| 9V DC                | AGN20009           | AGN21009        | AGN26009                            |
| 12V DC               | AGN20012           | AGN21012        | AGN26012                            |
| 24V DC               | AGN20024           | AGN21024        | AGN26024                            |

Standard packing: Tube: 50 pcs.; Case: 1,000 pcs.

### 2. Surface-mount terminal

#### 1) Tube packing

| Nominal coil voltage | Single side stable | 1 coil latching | High sensitivity single side stable |
|----------------------|--------------------|-----------------|-------------------------------------|
|                      | Part No.           | Part No.        | Part No.                            |
| 1.5V DC              | AGN200□1H          | AGN210□1H       | AGN260□1H                           |
| 3V DC                | AGN200□03          | AGN210□03       | AGN260□03                           |
| 4.5V DC              | AGN200□4H          | AGN210□4H       | AGN260□4H                           |
| 6V DC                | AGN200□06          | AGN210□06       | AGN260□06                           |
| 9V DC                | AGN200□09          | AGN210□09       | AGN260□09                           |
| 12V DC               | AGN200□12          | AGN210□12       | AGN260□12                           |
| 24V DC               | AGN200□24          | AGN210□24       | AGN260□24                           |

□: For each surface-mounted terminal identification, input the following letter. A type: A, S type: S

Standard packing: Tube: 50 pcs.; Case: 1,000 pcs.

#### 2) Tape and reel packing

| Nominal coil voltage | Single side stable | 1 coil latching | High sensitivity single side stable |
|----------------------|--------------------|-----------------|-------------------------------------|
|                      | Part No.           | Part No.        | Part No.                            |
| 1.5V DC              | AGN200□1HZ         | AGN210□1HZ      | AGN260□1HZ                          |
| 3V DC                | AGN200□03Z         | AGN210□03Z      | AGN260□03Z                          |
| 4.5V DC              | AGN200□4HZ         | AGN210□4HZ      | AGN260□4HZ                          |
| 6V DC                | AGN200□06Z         | AGN210□06Z      | AGN260□06Z                          |
| 9V DC                | AGN200□09Z         | AGN210□09Z      | AGN260□09Z                          |
| 12V DC               | AGN200□12Z         | AGN210□12Z      | AGN260□12Z                          |
| 24V DC               | AGN200□24Z         | AGN210□24Z      | AGN260□24Z                          |

□: For each surface-mounted terminal identification, input the following letter. A type: A, S type: S

Standard packing: Tape and reel: 500 pcs.; Case: 1,000 pcs.

Notes: 1. Tape and reel packing symbol "-Z" is not marked on the relay. "X" type tape and reel packing (picked from 1/2/3/4-pin side) is also available.

2. Please inquire if you require a relay, between 1.5 and 24 V DC, with a voltage not listed.

## RATING

### 1. Coil data

#### 1) Single side stable type

| Nominal coil voltage | Pick-up voltage (at 20°C 68°F)             | Drop-out voltage (at 20°C 68°F)            | Nominal operating current [±10%] (at 20°C 68°F) | Coil resistance [±10%] (at 20°C 68°F) | Nominal operating power | Max. applied voltage (at 20°C 68°F) |
|----------------------|--|--|---|---------------------------------------|-------------------------|-------------------------------------|
| 1.5V DC              | 75%V or less of nominal voltage* (Initial) | 10%V or more of nominal voltage* (Initial) | 93.8mA  | 16Ω                                   | 140mW                   | 150%V of nominal voltage            |
| 3V DC                |  |  | 46.7mA  | 64.2Ω                                 |                         |                                     |
| 4.5V DC              |  |  | 31mA  | 145Ω                                  |                         |                                     |
| 6V DC                |  |  | 23.3mA  | 257Ω                                  |                         |                                     |
| 9V DC                |  |  | 15.5mA  | 579Ω                                  |                         |                                     |
| 12V DC               |  |  | 11.7mA  | 1,028Ω                                |                         |                                     |
| 24V DC               |  |  | 9.6mA   | 2,504Ω                                | 230mW                   | 120%V of nominal voltage            |

#### 2) 1 coil latching type

| Nominal coil voltage | Set voltage (at 20°C 68°F)                 | Reset voltage (at 20°C 68°F)               | Nominal operating current [±10%] (at 20°C 68°F) | Coil resistance [±10%] (at 20°C 68°F) | Nominal operating power | Max. applied voltage (at 20°C 68°F) |
|----------------------|--|--|---|---------------------------------------|-------------------------|-------------------------------------|
| 1.5V DC              | 75%V or less of nominal voltage* (Initial) | 75%V or less of nominal voltage* (Initial) | 66.7mA  | 22.5Ω                                 | 100mW                   | 150%V of nominal voltage            |
| 3V DC                |  |  | 33.3mA  | 90Ω                                   |                         |                                     |
| 4.5V DC              |  |  | 22.2mA  | 202.5Ω                                |                         |                                     |
| 6V DC                |  |  | 16.7mA  | 360Ω                                  |                         |                                     |
| 9V DC                |  |  | 11.1mA  | 810Ω                                  |                         |                                     |
| 12V DC               |  |  | 8.3mA   | 1,440Ω                                |                         |                                     |
| 24V DC               |  |  | 5.0mA   | 4,800Ω                                | 120mW                   |                                     |

\*Pulse drive (JIS C 5442-1996)

### 3) High sensitivity single side stable type

| Nominal coil voltage | Set voltage (at 20°C 68°F)                 | Reset voltage (at 20°C 68°F)               | Nominal operating current [±10%] (at 20°C 68°F) | Coil resistance [±10%] (at 20°C 68°F) | Nominal operating power | Max. applied voltage (at 20°C 68°F) |
|----------------------|--|--|---|---------------------------------------|-------------------------|-------------------------------------|
| 1.5V DC              | 80%V or less of nominal voltage* (Initial) | 10%V or more of nominal voltage* (Initial) | 66.7mA  | 22.5Ω                                 | 100mW                   | 150%V of nominal voltage            |
| 3V DC                |  |  | 33.3mA  | 90Ω                                   |                         |                                     |
| 4.5V DC              |  |  | 22.2mA  | 202.5Ω                                |                         |                                     |
| 6V DC                |  |  | 16.7mA  | 360Ω                                  |                         |                                     |
| 9V DC                |  |  | 11.1mA  | 810Ω                                  |                         |                                     |
| 12V DC               |  |  | 8.3mA   | 1,440Ω                                |                         |                                     |
| 24V DC               |  |  | 5.0mA   | 4,800Ω                                | 120mW                   | 120%V of nominal voltage            |

\*Pulse drive (JIS C 5442-1996)

## 2. Specifications

| Characteristics                          | Item   | Specifications   |   |
|--|--|--|---|
| Contact                                  | Arrangement  | 2 Form C   |   |
|  | Initial contact resistance, max.   | Max. 100 mΩ (By voltage drop 6 V DC 1A)  |   |
|  | Contact material   | Stationary contact: AgPd+Au clad Movable contact: AgPd   |   |
| Rating                                   | Nominal switching capacity   | 1 A 30 V DC, 0.3 A 125 V AC (resistive load)   |   |
|  | Max. switching power   | 30 W (DC), 37.5 V A (AC) (resistive load)  |   |
|  | Max. switching voltage   | 110 V DC, 125 V AC   |   |
|  | Max. switching current   | 1 A  |   |
|  | Min. switching capacity (Reference value)*1  | 10μA 10 mV DC  |   |
|  | Nominal operating power  | Single side stable   | 140mW (1.5 to 12 V DC), 230mW (24 V DC)   |
|  |  | High sensitivity single side stable type   | 100mW (1.5 to 12 V DC), 120mW (24 V DC)   |
| 1 coil latching                          |  |  |   |
| Electrical characteristics               | Insulation resistance (Initial)  | Min. 1,000MΩ (at 500V DC)<br>Measurement at same location as "Initial breakdown voltage" section.  |   |
|  | Breakdown voltage (Initial)  | Between open contacts  | 750 Vrms for 1min. (Detection current: 10mA)  |
|  |  | Between contact and coil   | 1,500 Vrms for 1min. (Detection current: 10mA)  |
|  |  | Between contact sets   | 1,000 Vrms for 1min. (Detection current: 10mA)  |
|  | Surge breakdown voltage (Initial)  | Between open contacts  | 1,500 V (10×160μs) (FCC Part 68)  |
|  |  | Between contacts and coil  | 2,500 V (2×10μs) (Telcordia)  |
|  | Temperature rise (at 20°C 68°F)  | Max. 50°C<br>(By resistive method, nominal coil voltage applied to the coil; contact carrying current: 1A.)  |   |
| Operate time [Set time] (at 20°C 68°F)   | Max. 4 ms [Max. 4 ms] (Nominal coil voltage applied to the coil, excluding contact bounce time.)                 |  |   |
| Release time [Reset time] (at 20°C 68°F) | Max. 4 ms [Max. 4 ms] (Nominal coil voltage applied to the coil, excluding contact bounce time.) (without diode) |  |   |
| Mechanical characteristics               | Shock resistance   | Functional   | Min. 750 m/s <sup>2</sup> (Half-wave pulse of sine wave: 6 ms; detection time: 10μs.) |
|  |  | Destructive  | Min. 1,000 m/s <sup>2</sup> (Half-wave pulse of sine wave: 6 ms.)                     |
|  | Vibration resistance   | Functional   | 10 to 55 Hz at double amplitude of 3.3 mm (Detection time: 10μs.)                     |
|  |  | Destructive  | 10 to 55 Hz at double amplitude of 5 mm   |
| Expected life                            | Mechanical   | Min. 5 × 10 <sup>7</sup> (at 180 cpm)  |   |
|  | Electrical   | Min. 10 <sup>5</sup> (1 A 30 V DC resistive), 10 <sup>5</sup> (0.3 A 125 V AC resistive) (at 20 cpm)   |   |
| Conditions                               | Conditions for operation, transport and storage*2  | Ambient temperature:<br>(Single side stable, 1 coil latching type) -40°C to +85°C -40°F to +185°F<br>(High sensitivity single side stable type) -40°C to +70°C -40°F to +158°F<br>Humidity: 5 to 85% R.H. (Not freezing and condensing at low temperature) |   |
|  | Max. operating speed (at rated load)   | 20 cpm   |   |
| Unit weight                              |  | Approx. 1 g .035 oz  |   |

Notes:

\*1 This value can change due to the switching frequency, environmental conditions, and desired reliability level, therefore it is recommended to check this with the actual load.

\*2 Refer to "6. Usage, Storage and Transport Conditions" in [AMBIENT ENVIRONMENT](#) section in [Relay Technical Information](#).

### REFERENCE DATA

#### 1. Max. switching capacity

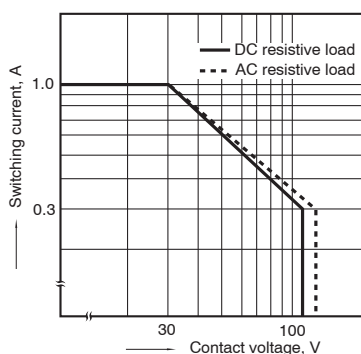

#### 2. Life curve

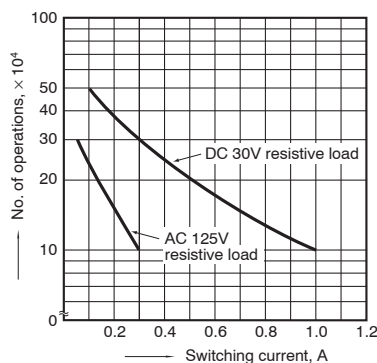

#### 3. Mechanical life

Tested sample: AGN2004H, 15 pcs.; Operating speed: 180 cpm

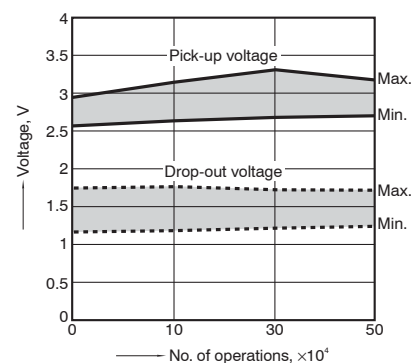

# GN (AGN)

## 4. Electrical life (1A 30V DC resistive load)

Tested sample: AGN2004H, 6 pcs.

Operating speed: 20 cpm

Change of pick-up and drop-out voltage

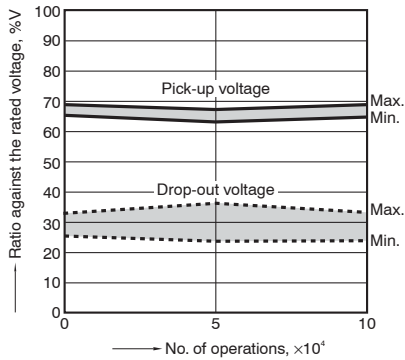

Change of contact resistance

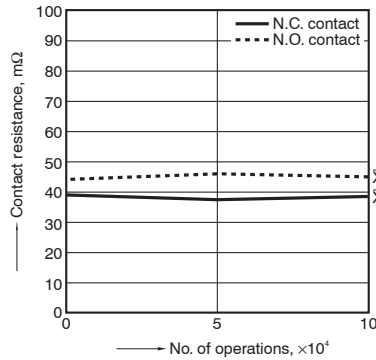

## 5. Coil temperature rise

Tested sample: AGN2004H, AGN20024, 6 pcs.

Point measured: Inside the coil

Ambient temperature: Room temperature

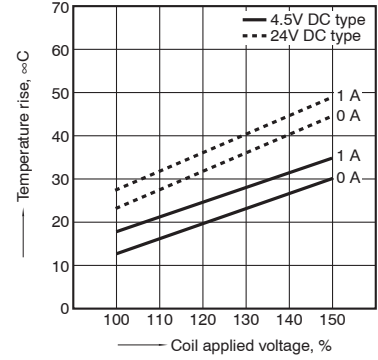

## 6-(1). Operate and release time (without diode)

Tested sample: AGN2004H, 6 pcs.

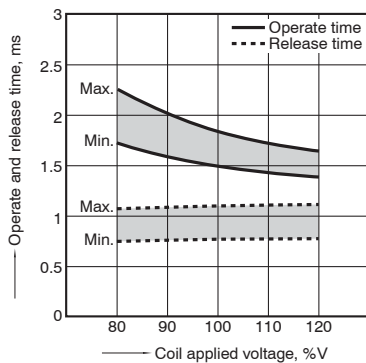

## 6-(2). Operate and release time (with diode)

Tested sample: AGN2004H, 6 pcs.

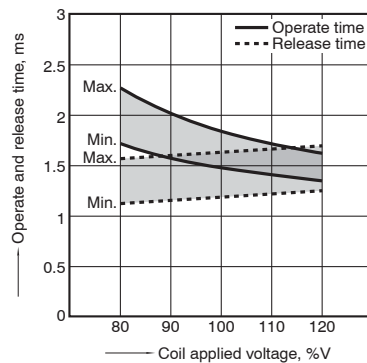

## 7. Ambient temperature characteristics

Tested sample: AGN2004H, 6 pcs.

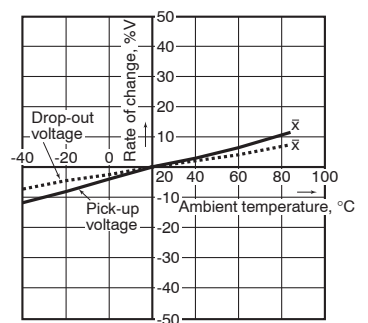

## 8. Malfunctional shock

Tested sample: AGN2004H

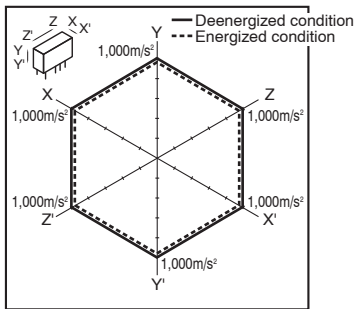

## 9-(1). Influence of adjacent mounting

Tested sample: AGN20012, 6 pcs.

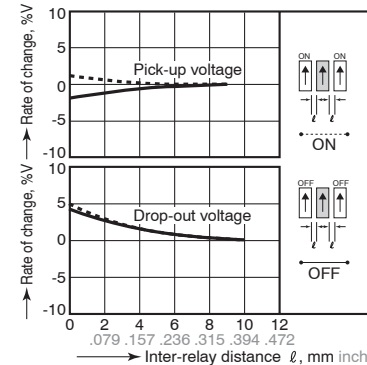

## 9-(2). Influence of adjacent mounting

Tested sample: AGN20012, 6 pcs.

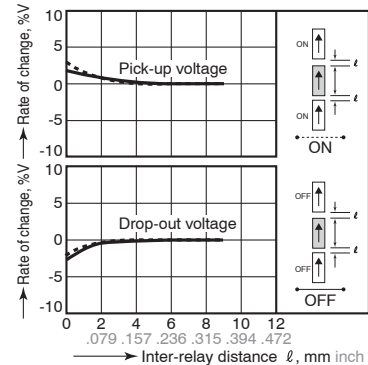

# DIMENSIONS (mm inch)

## 1. PC board terminal

[CAD Data](#)

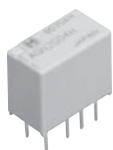

External dimensions  
Standard type

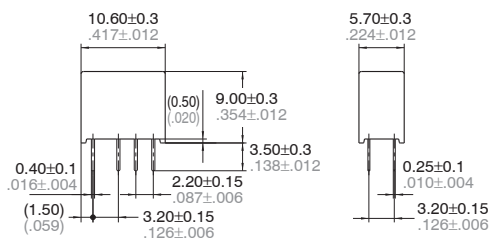

PC board pattern

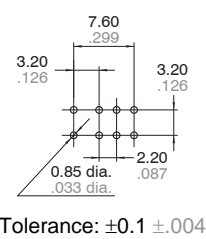

Schematic (Bottom view)

Single side stable  
High sensitivity  
single side stable

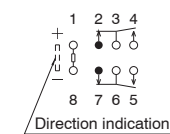

(Deenergized condition)

1 coil latching

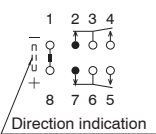

(Reset condition)

2. Surface-mount terminal

CAD Data



| Type   | External dimensions  |  | Suggested mounting pad (Tolerance: $\pm 0.1 \pm .004$ )                |  |
|--------|--|--|--|--|
|        | Single side stable/1 coil latching/High sensitivity single side stable |  | Single side stable/1 coil latching/High sensitivity single side stable |  |
| A type |  |  |  |  |
| S type |  |  |  |  |

Schematic (Top view)

Single side stable  
High sensitivity single side stable

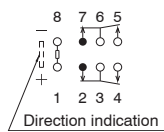

(Deenergized condition)

1 coil latching

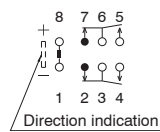

(Reset condition)

NOTES

1. Packing style

1) The relay is packed in a tube with the relay orientation mark on the left side, as shown in the figure below.

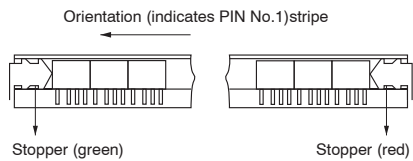

2) Tape and reel packing

(A type)

(1)-1 Tape dimensions

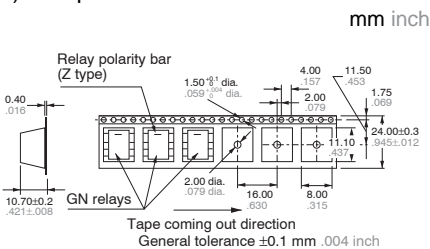

(S type)

(1)-2 Tape dimensions

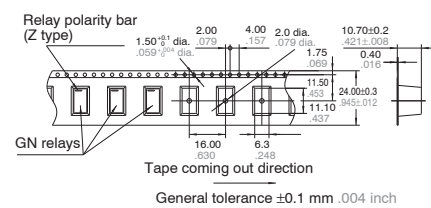

(2) Dimensions of plastic peel

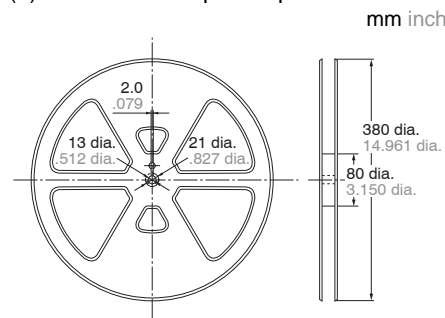

2. Automatic insertion

To maintain the internal function of the relay, the chucking pressure should not exceed the values below.

- Chucking pressure in the direction A: 4.9 N {500gf} or less
- Chucking pressure in the direction B: 9.8 N {1 kgf} or less
- Chucking pressure in the direction C: 9.8 N {1 kgf} or less

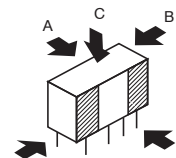

Please chuck the portion. Avoid chucking the center of the relay. In addition, excessive chucking pressure to the pinpoint of the relay should be avoided.

For Cautions for Use, see [Relay Technical Information](#).

## X-ON Electronics

Largest Supplier of Electrical and Electronic Components

*Click to view similar products for [Low Signal Relays - PCB category](#):*

*Click to view products by [Panasonic manufacturer](#):*

Other Similar products are found below :

[LZN4-US-DC12](#) [LZNQ4-US-DC24](#) [LZNQ4-US-DC48](#) [6-1393813-4](#) [6-1462039-0](#) [6-1617347-5](#) [6-1617353-3](#) [6-1617529-6](#) [617-12](#)  
[M39016/20-054M](#) [M39016/27-030M](#) [67RPCX-3](#) [MAHC-5494](#) [D3493L](#) [7-1393809-0](#) [7-1393813-3](#) [741B8](#) [7556072001](#) [MF-11AM-24](#)  
[MF1201N12](#) [MF-17A-24](#) [FBR244D012/02CP](#) [FBR244D024/02CS](#) [80.010.4522.1](#) [FL-4036](#) [FLH-11D-6](#) [831A7](#) [MMS124](#) [FTR-B4GA006Z](#)  
[FW1102S06](#) [FW1201S39](#) [FW1210S02](#) [FW1521S01](#) [FW5A1201S14](#) [9-1393813-6](#) [9-1617582-5](#) [G6AK-2-H-DC5](#) [G6E-184P-ST-US-DC48](#)  
[G6G234CDC24](#) [A07A939BZ1-0388](#) [A150-0005](#) [PZ-2A2420](#) [HB1-DC6V](#) [HB1-DC9V](#) [R10-14A10-240](#) [R10-14D10-12](#) [R10-5A10-120F](#)  
[R10-E1L8-S200](#) [R10-E2468-1](#) [R10-E4Z2-V700](#)