

Model : AM-1456CA

1. Outside dimensions 外形寸法

Light Receiving Side (受光面)

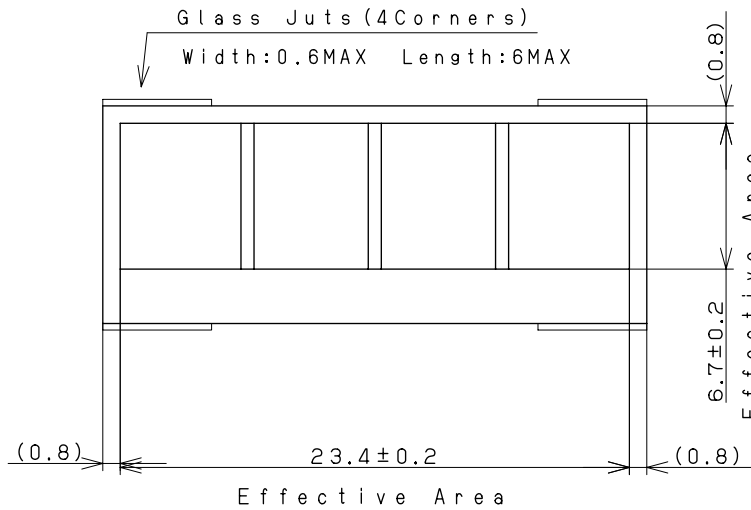

Overcoat Side (オーバーコート面)

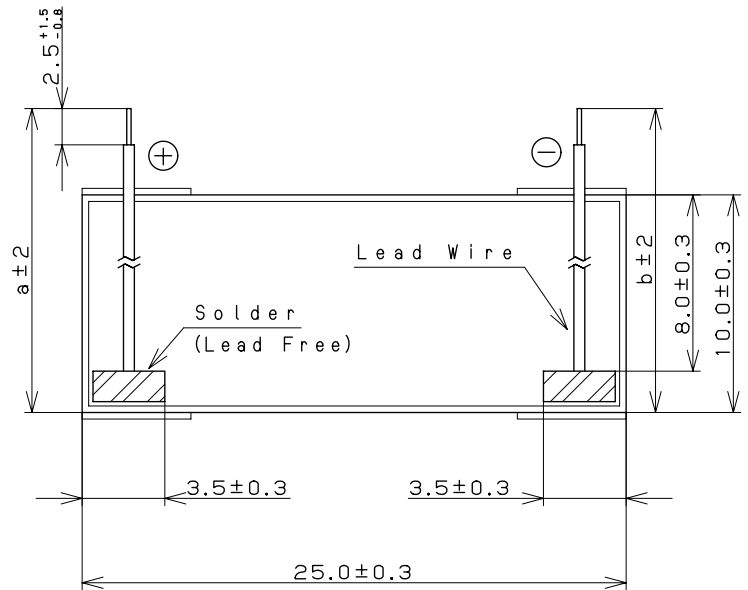

(dimension: mm)

Lead Wires : AWG30	
a: 51	b: 51

Note

Glass Substrate Thickness (ガラス基板厚) : $1.1 \text{ mm} \pm 0.1$ Module Thickness (モジュール厚) : 1.3 mm MAX Wire-Overcoat thickness: 2.5 mm MAX (including Module)
(リード線補正コート厚)

2. Rated Specifications (at 25°C)

Item	Specifications (Initial)		
2.1 Open circuit voltage: Voc 開放電圧	Typical	2.4V	at 200Lx FL
2.2 Short circuit Current: Isc 短絡電流	Typical	6.0 μ A	at 200Lx FL
2.3 Operating Voltage & Operating Current: Vope-lope 動作特性	Typical	1.4V - 1.3 μ A	at 50Lx FL
	Minimum	1.5V - 4.0 μ A	at 200Lx FL
	Typical	1.5V - 5.3 μ A	at 200Lx FL
2.5 Working temperature range: Topr 動作温度範囲	-10 to 60°C		
2.6 Storage temperature range: Tstg 保存温度範囲	-20 to 70°C		
2.7 Working illuminance range 使用照度範囲	~1000Lx		

FL: White Fluorescent Light

I - V Characteristics

REFERENCE

1.Model : AM-1456

2.Outside Dimension : 25.0mm × 10.0mm

FL:White Fluorescent Light

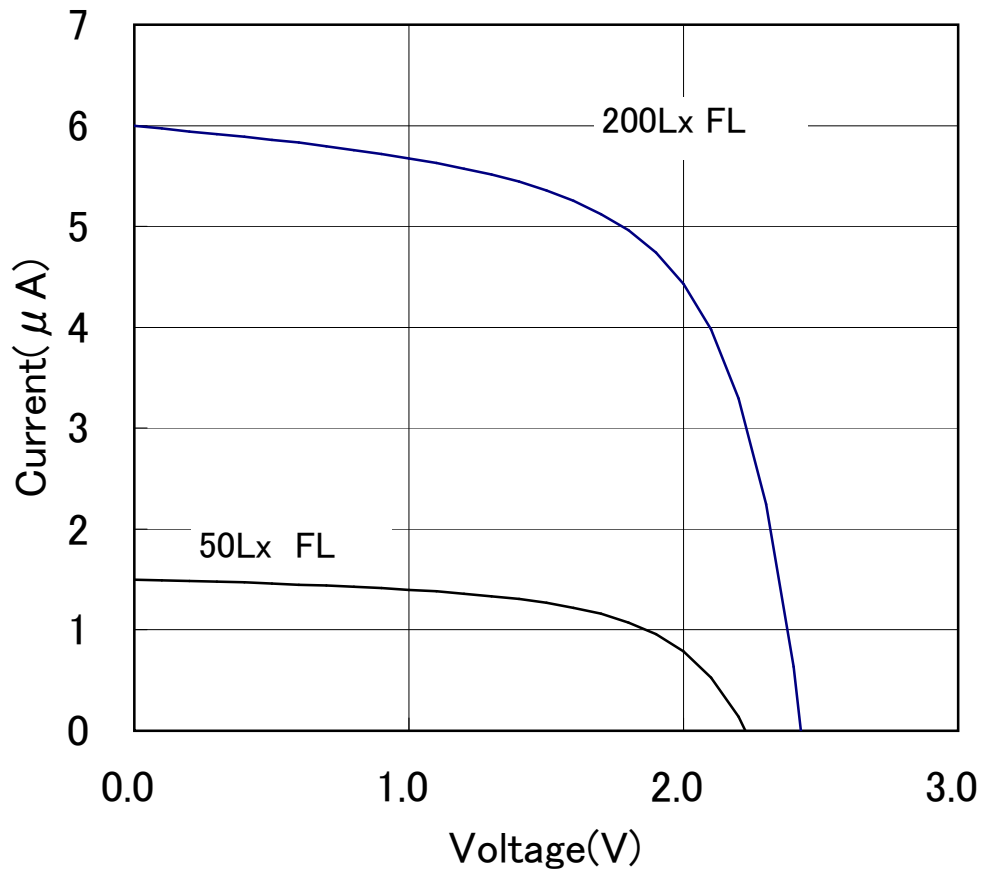

*このデータは標準的な出力特性を示すものであり、特性を保証するものではありません。

*The data are meant to show standard electric characteristics only , not intended to guarantee the characteristics.

Panasonic Eco Solutions Amorton Co.,Ltd.

2014/1/10

出力の照度依存特性

REFERENCE

Dependence of Output on Illumination

1.Model : AM-1456

2.Outside Dimension : 25.0mm × 10.0mm

FL:White Fluorescent Light

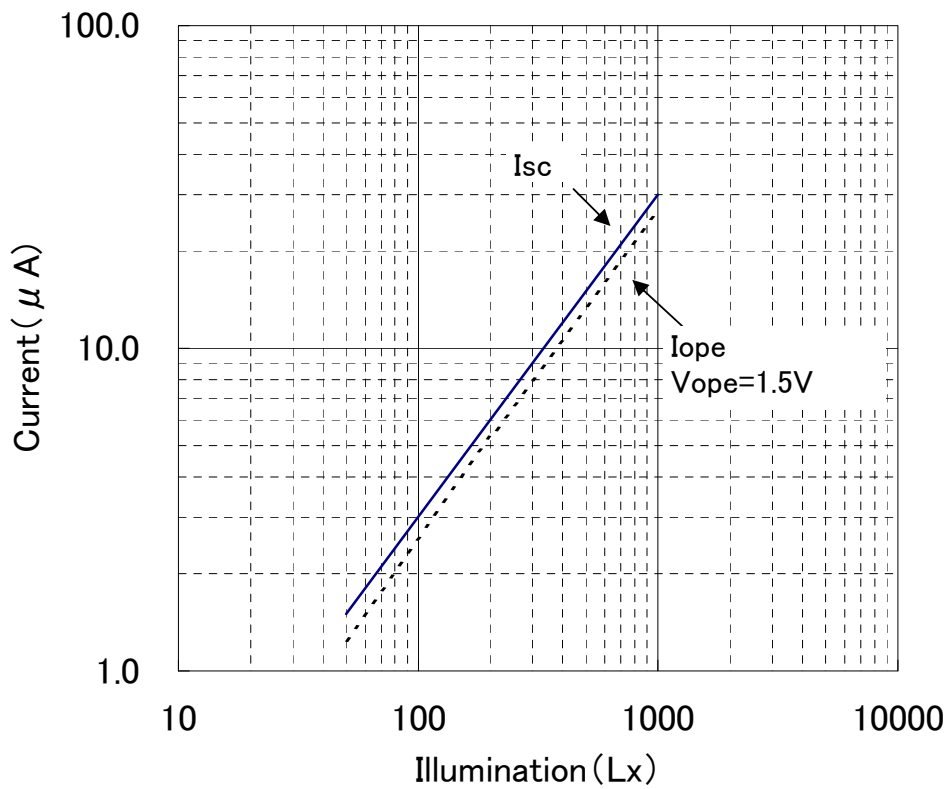
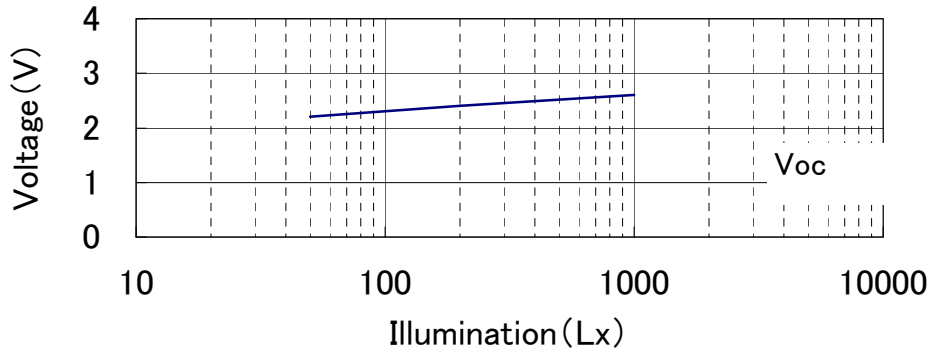

*このデータは標準的な出力特性を示すものであり、特性を保証するものではありません。

*The data are meant to show standard electric characteristics only , not intended to guarantee the characteristics.

出力の温度依存特性

REFERENCE

Dependence of Output on Temperature

1.Model : AM-1456

2.Outside Dimension : 25.0mm × 10.0mm

at 200Lx White Fluorescent Light

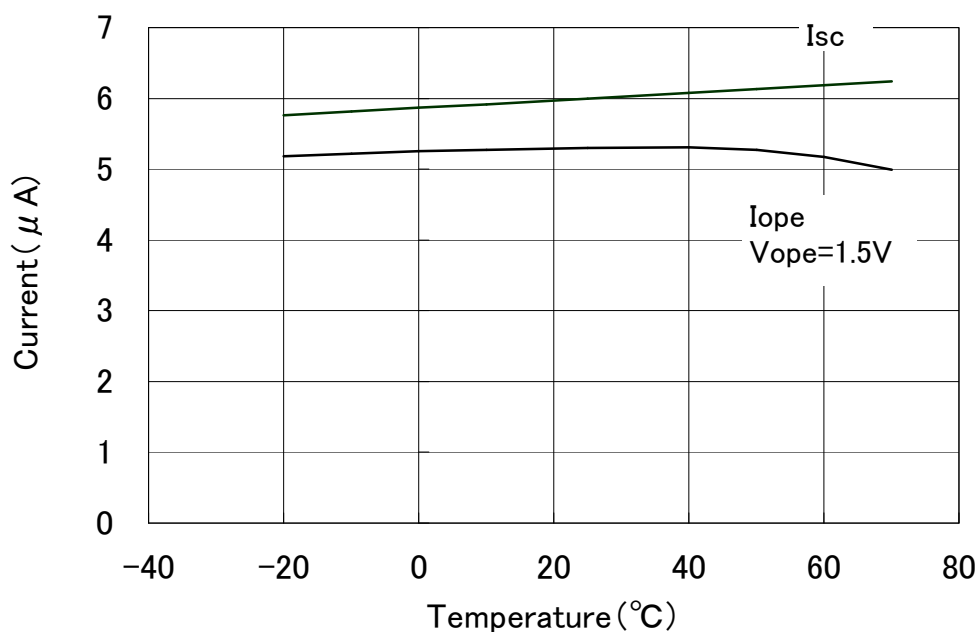
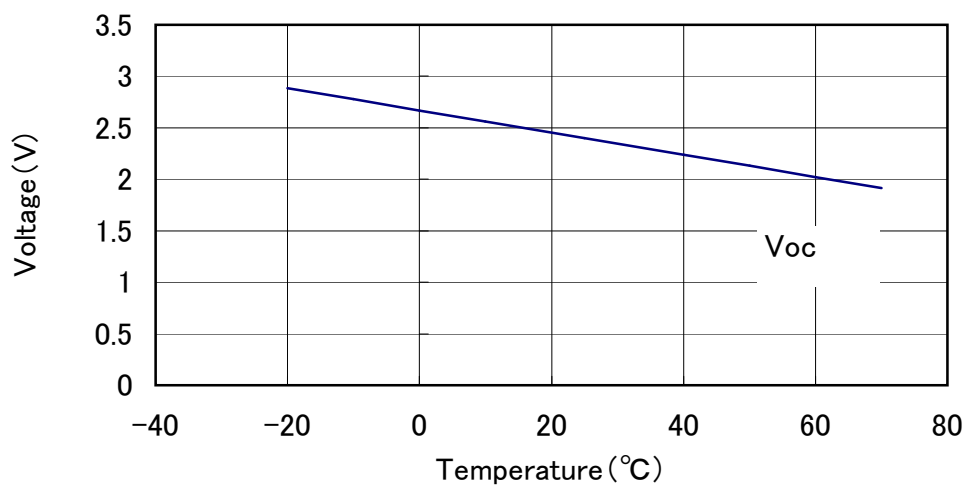

*このデータは標準的な出力特性を示すものであり、特性を保証するものではありません。

*The data are meant to show standard electric characteristics only, not intended to guarantee the characteristics.

X-ON Electronics

Largest Supplier of Electrical and Electronic Components

Click to view similar products for [Solar Panels & Solar Cells](#) category:

Click to view products by [Panasonic](#) manufacturer:

Other Similar products are found below :

[AM-1606C-MEL](#) [200](#) [2747](#) [SC10050](#) [SC20072](#) [SC20050](#) [SC20036](#) [SC10036](#) [AM-1513CA](#) [AM-1719CA](#) [AM-1805CA](#) [AM-1820CA](#) [500](#)
[1525](#) [3809](#) [MIKROE-651](#) [AM-1417CA](#) [AM-1454CA](#) [AM-1456CA](#) [AM-1801CA](#) [AM-1815CA](#) [AM-1816CA](#) [AM-1819CA](#) [AM-5608CAR](#)
[AM-5610CAR](#) [AM-5706CAR](#) [AM-5902CAR](#) [AM-5904CAR](#) [AM-8702CAR](#) [AT-7665A](#) [LL200-2.4-75](#) [LL200-3-37](#) [LL200-3.6-75](#) [LL200-](#)
[4.8-37](#) [MP3-25](#) [MP3-37](#) [MP7.2-150F](#) [MP7.2-75F](#) [MPT15-150](#) [MPT15-75](#) [MPT3.6-150](#) [MPT3.6-75](#) [MPT4.8-150](#) [MPT4.8-75](#) [MPT6-150](#)
[MPT6-75](#) [P7.2-150F](#) [P7.2-75F](#) [PT15-150](#) [PT15-300](#)