

# Amorphous Silicon Solar Cells Amorphous Photosensors

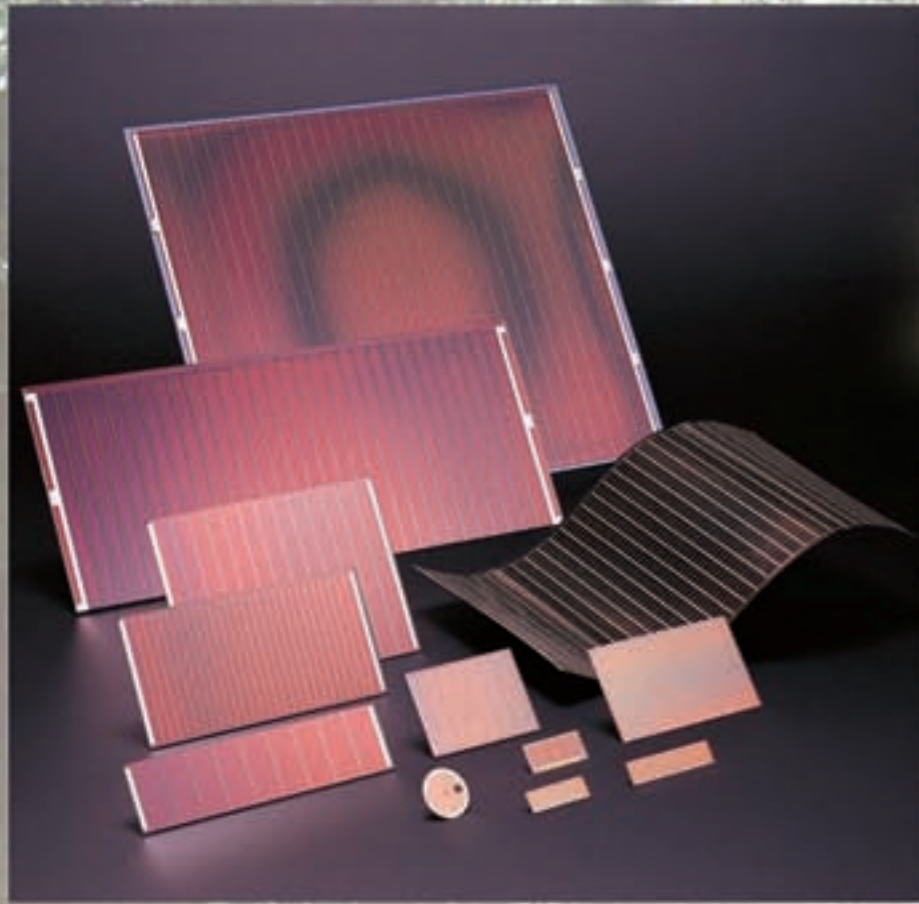



*The development of the solar cell is progressing with rapid speed. As a new energy tool which can effectively harness the amazing power of sunlight, solar cells have the potential to replace fossil fuels as our main means of power generation. Solar energy is both a clean and inexhaustible resource, and it can be used to produce electricity wherever and whenever sunlight is available. Of these technologies, amorphous silicon solar cells have many strengths that surpass those of the earlier crystalline silicon solar cells. In addition, they require little energy to manufacture and use less raw materials, and thus are truly environmentally friendly devices. This technology also allows larger area cells to be manufactured and can take advantage of the flexibility of thin film materials, and they have already been used in a wide range of applications. SANYO was one of the first companies to focus on amorphous silicon solar cells, and developed and is now mass producing the Amorton integrated type amorphous silicon solar cells that feature a new device structure.*

# Amorton

## The Concept Behind Solar Cell Power Generation

Solar cell power is generated using the photovoltaic effect of semiconductors. When a semiconductor is exposed to a light source of suitable intensity, a large number of pairs of an electron and a positive hole are generated as a result of the reciprocal action between photons and silicon atoms.

At a p/n junction between two different semiconductor materials, the electrons are diffused in the n-type material and the positive holes are scattered in the p-type material. They are then collected at both electrodes respectively, resulting in a voltage difference between the electrodes.

When an external load is connected, electricity flows through the load. In this way, an a-Si solar cell converts light energy into electricity and supplies power to external loads.

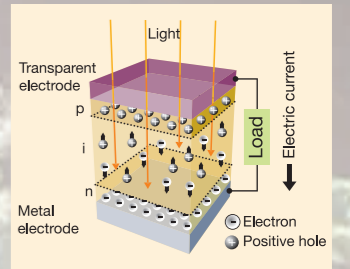

## Amorphous Silicon Solar Cells

Solar cells are classified according to the material employed, i.e., crystal silicon, amorphous silicon, and compound semiconductor solar cells. "Amorphous" refers to objects having no definite shape and is defined as non-crystal material.

Unlike crystal silicon, in which atomic arrangements are regular, amorphous silicon features irregular atomic arrangements as shown in the figures below.

As a result, the reciprocal action between photons and silicon atoms occurs more frequently in amorphous silicon than in crystal silicon, allowing much more light to be absorbed. Thus, an ultra-thin amorphous silicon film of less than  $1\mu\text{m}$  can be produced and used for power generation. Also, by utilizing metal or plastics for the substrate, flexible solar cells can be produced.





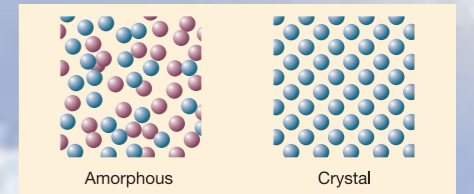

Amorton is an integrated amorphous silicon solar cell which has been developed by SANYO.

Amorton uses silane ( $\text{SiH}_4$ ) as its source gas and is fabricated using a plasma CVD method.

Three amorphous silicon layers æ p-layer, i-layer, and n-layer æ are formed consecutively on a glass substrate. This p-i-n junction corresponds to the p/n junction of a crystal silicon solar cell. In the process of this junction formation, a number of cells are connected in series on a substrate at one time. This allows any desired voltage to be obtained for a variety of equipment operation.



Features of Amorton

Place used	Substrate	Feature	Reference
Indoors	Glass 	Low price (basic substrate)	Page 5
	Stainless steel 	Thin, light weight, unbreakable, can easily be formed in arbitrary shapes, highly precise dimensions	Contact your SANYO representative.
	Film 	Thin, light weight, unbreakable, bendable, can easily be formed in arbitrary shapes	Contact your SANYO representative.
Outdoors	Glass 	Low price (basic substrate)	Page 5
	Stainless steel 	Thin, light weight, unbreakable, can easily be formed in arbitrary shapes, highly precise dimensions	Contact your SANYO representative.
	Film 	Thin, light weight, unbreakable, bendable, can easily be formed in arbitrary shapes	Page 6
Visible light sensor	—	Support designs with arbitrary sizes and patterns as required by the application	Page 9

Contact: The person in charge of Amorton products TEL. +81-3-4574-6345

n Relationship between illumination level and output

The figure shows the relationship between illumination level and output. There is an enormous difference between the illumination levels indoors and outdoors. SANYO provides two types of products, indoor products for use in the low illumination levels common in indoor environments and outdoor products for the high illumination levels common outdoors.

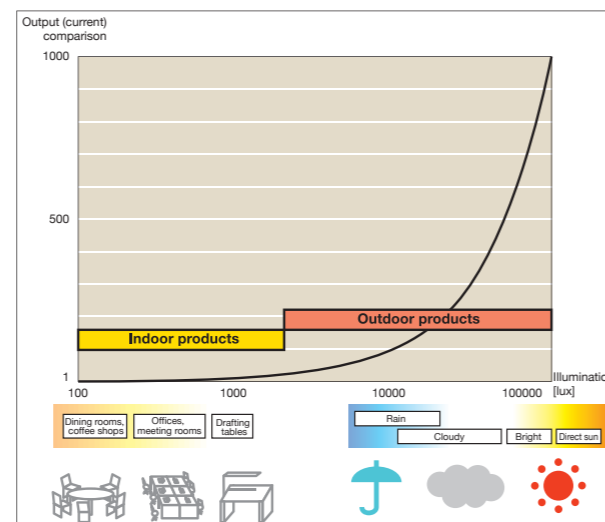

n Relationships between number of rows of the cell and cell area (Illumination level is constant.)

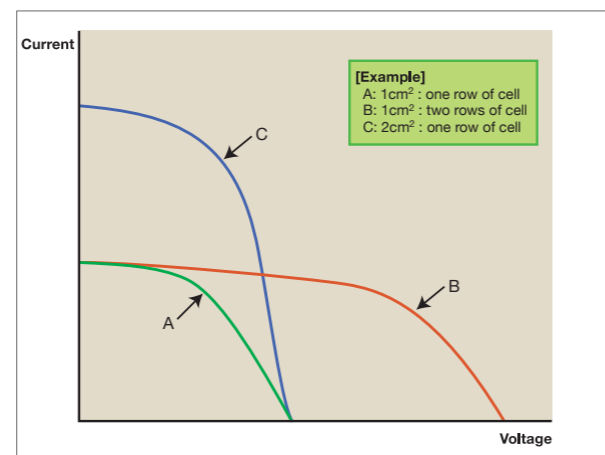

n Solar cells with a variety of voltages can be created

Since, unlike the fabrication technique used with crystalline solar cells in which cells cut apart and then connected, multiple cells can be connected in series at the same time as the cells are formed, it is easy to create batteries with a variety of voltages. (This series connection idea is the same as that used with regular batteries.)

n Solar cells with a variety of shapes can be created

The methods used to form amorphous films have special features that allow other substrates, such as stainless steel or plastic films, to be used in place of the usual glass substrate. This means that previously unknown solar cells, solar cells that are round, square, or any complex shape, or solar cells that can be bent, can be created. It is also possible to create areas in these solar cells that consist of just transparent glass by etching.

n High sensitivity in the visible light region

The human eye is sensitive to light with wavelengths from about 400 nm to 700 nm. Since amorphous silicon solar cells are sensitive to light with essentially the same wavelengths, in addition to solar cells, they can also be used as visible light sensors.

Application Examples

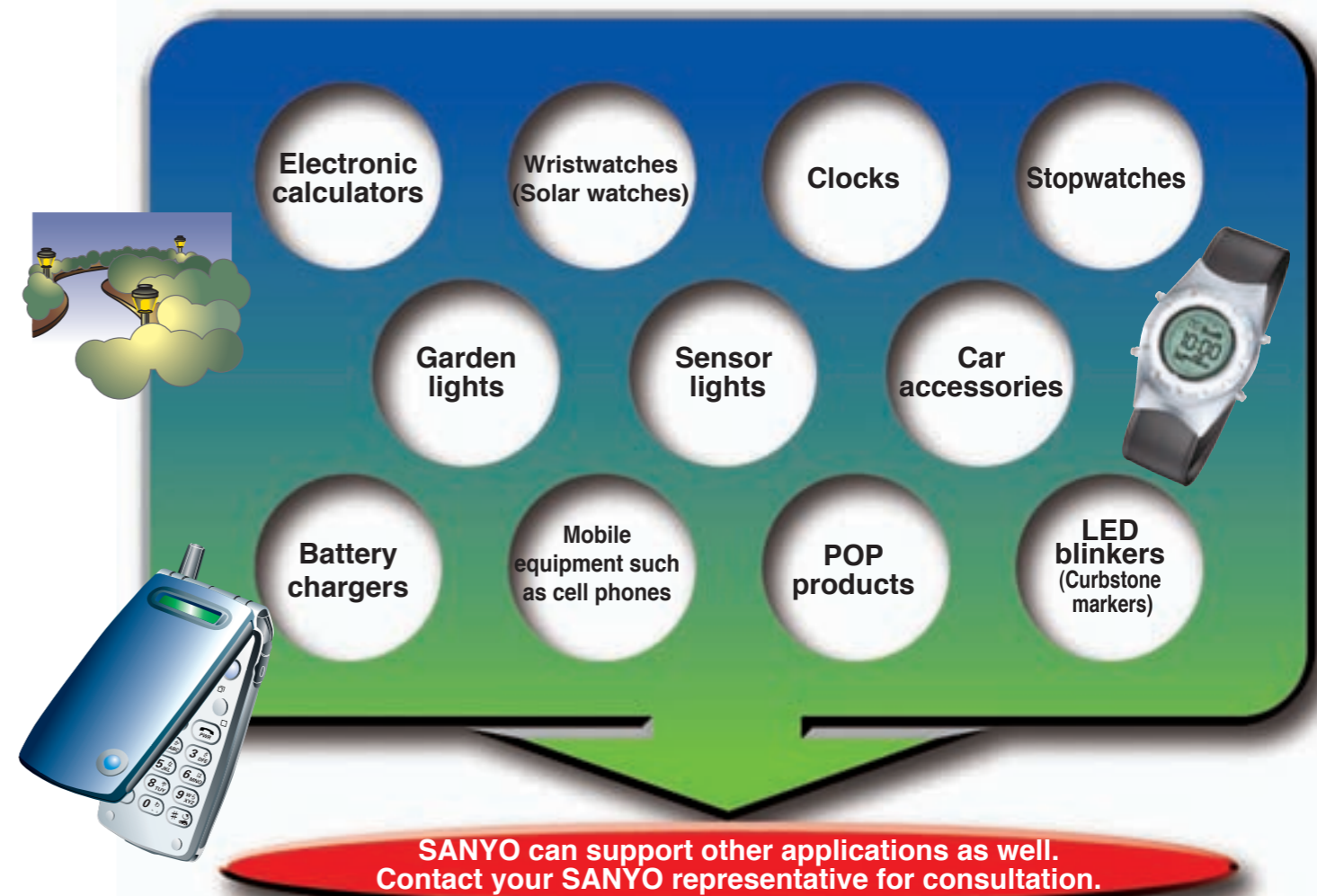

SANYO can support other applications as well. Contact your SANYO representative for consultation.



## Features of Amorton

The features of Amorton are shown by the current-voltage curve in the figure.  
The curve changes depending on the incident light intensity and the surrounding temperature.

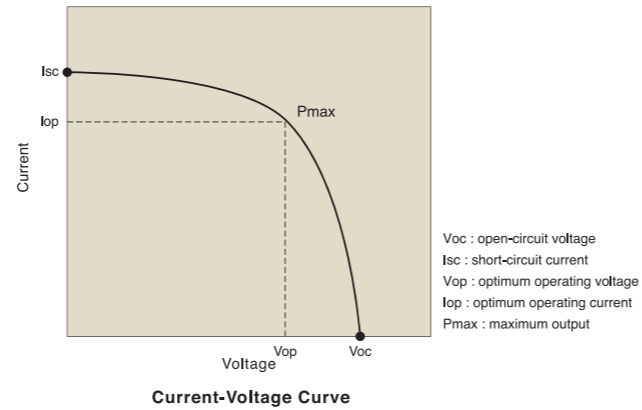

## Output Characteristics

### Output Characteristics of Indoor use Amorton

Artificial light, such as fluorescent and incandescent light, is used indoors. The illuminance of these light sources ranges from 20 lux to 1,000 lux. Indoors, therefore, Amorton is most suitable for small equipment such as electronic calculators. Please use under 1,000 lux.

Typical Cell Characteristics (25°C)

Open-circuit voltage	Short-circuit current	Maximum output	Light source
0.63 V/cell	17.0 $\mu$ A/cm <sup>2</sup>	7.0 $\mu$ W/cm <sup>2</sup>	FL200lux

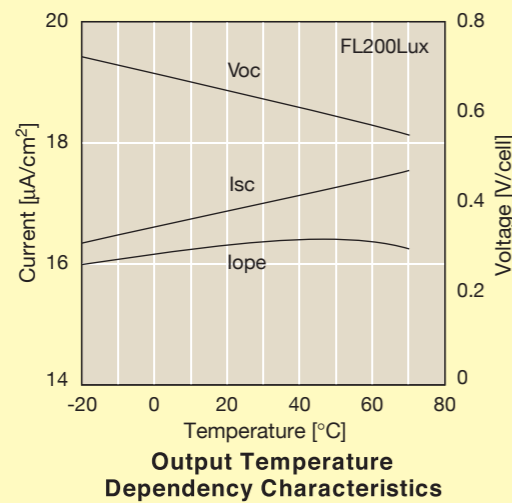
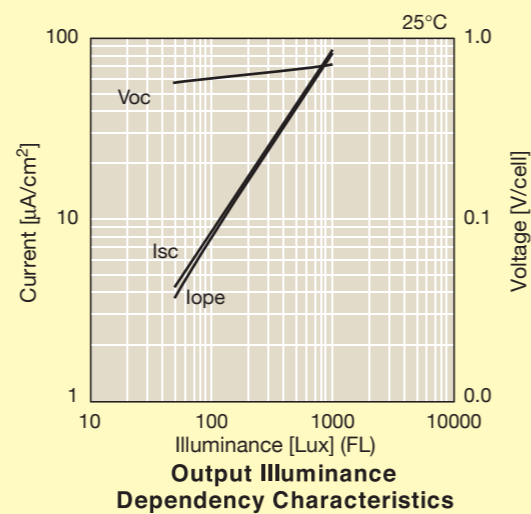
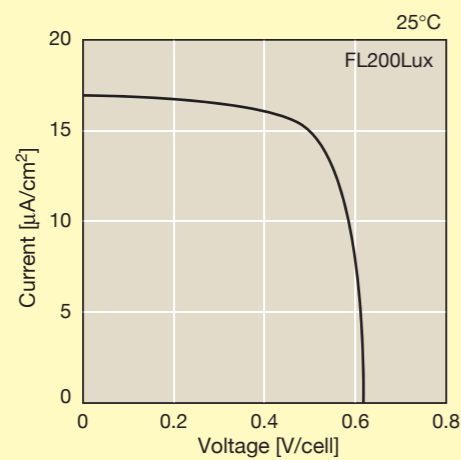

FL: fluorescent light  
Voc: open-circuit voltage  
Isc: short-circuit current  
Iope: operating current

Temperature coefficient  
Voc: -0.3%/°C  
Isc: +0.08%/°C  
Pmax: -0.2%/°C

### Output Characteristics of outdoor use Amorton

Natural light ranges in illuminance from 10,000 lux to 100,000 lux (AM-1.5, 100mW/cm<sup>2</sup>) or more. Amorton is suitable outdoors for compact equipment such as chargers.

Typical Cell Characteristics (25°C)

Open-circuit voltage	Short-circuit current	Maximum output	Light source
0.89V/cell	14.8mA/cm <sup>2</sup>	7.89mW/cm <sup>2</sup>	AM-1.5, 100mW/cm <sup>2</sup>

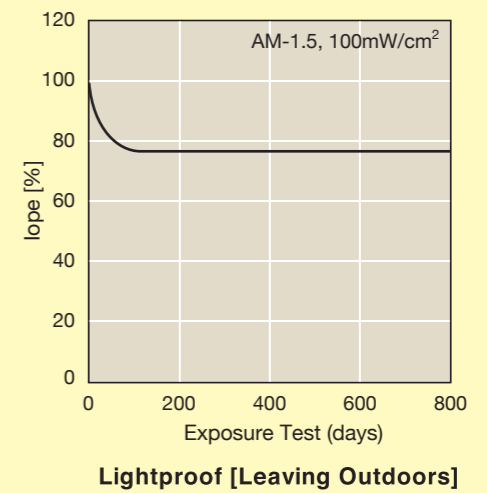
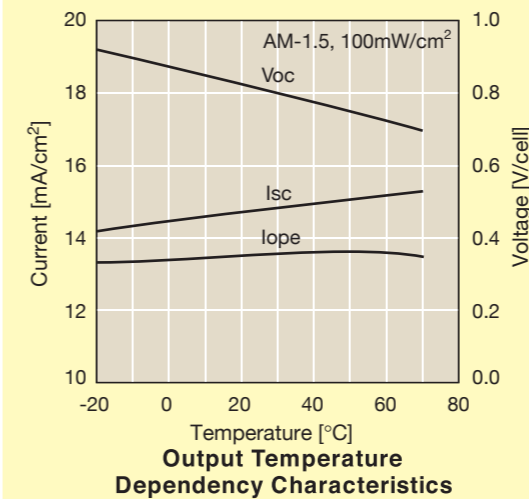
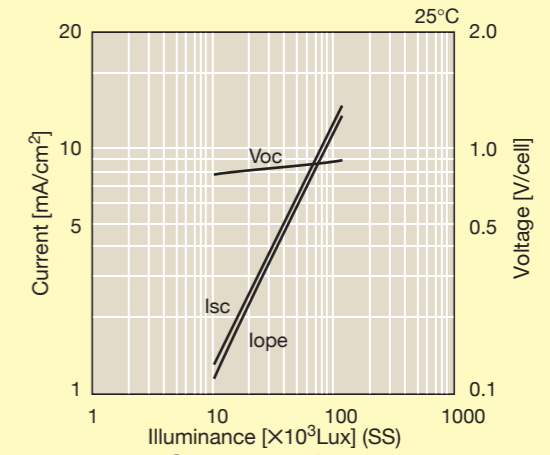
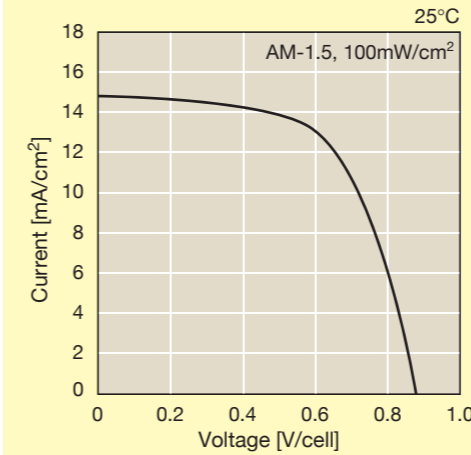

SS: solar simulator  
(false solar light source)  
Voc: open-circuit voltage  
Isc: short-circuit current  
Iope: operating current

Temperature coefficient  
Voc: -0.3%/°C  
Isc: +0.08%/°C  
Pmax: -0.2%/°C

## Terminal Configurations

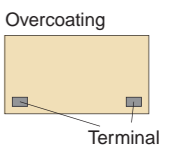

Indoors				Outdoors
B type	C type	CS type	CA type	CAR type C type also possible
Cannot be soldered. A heat seal is usable.	Lead wire can be attached with regular solder.	Temporary solder is attached to a C type device.	C type terminal with lead wire.	The pins are protected with a resin coating after the leads are attached

## Amorton Photosensors List

Model		Number of elements	External dimensions (mm)	Short-circuit current TYP.	Dark current (V= 50mV) MAX.
AM-30-11	C, CS, CA	1	14.0 × 13.0 (Glass 1.1t)	17.7μA*1	—
AM-30-15	C	2	5.05 × 3.05 (Glass 0.7t)	Center area: 80nA*2 Around area: 2.8μA*2	Center area: 100pA Around area: 100pA
AM-30-16	C	3	5.05 × 3.05 (Glass 0.7t)	Center area: 50nA*2 Around area (Inside): 0.4μA*2 Around area (Outside): 1.3μA*2	Center area: 100pA Around area (Inside): 100pA Around area (Outside): 100pA
AM-30-28	CS	1	5.0 × 3.0 (Glass 0.7t)	7.5μA*2	10pA
AM-30-31	C	1	2.1 × 2.0 (Glass 0.4t)	1.2μA*2	10pA
AM-30-33	C	1	5.0 × 3.0 (Glass 0.7t)	7.5μA*2	10pA

\*1: At 200lux, white fluorescent light  
\*2: At 1000lux, fluorescent light for color illuminator  
\* For terminal configurations, refer to page 8.

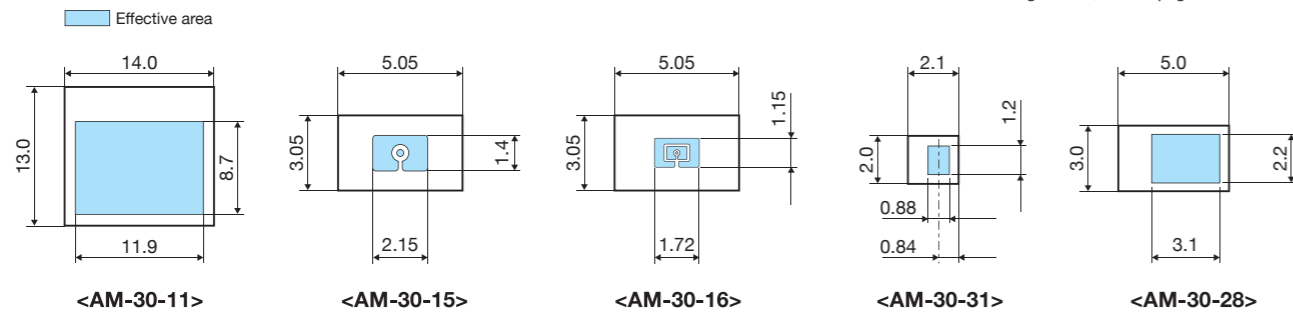

SANYO can also provide custom products.

## Features of Amorton Photosensors

Amorphous Photosensor is a kind of Photo Diode, and can detect light and its intensity.

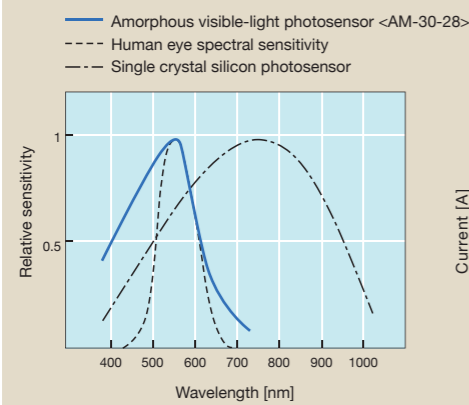

Spectral Sensitivity of Amorphous Photosensor

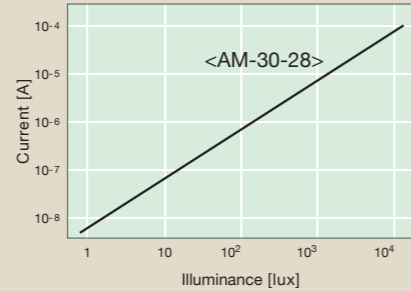

Dependence of Isc Characteristics on Illumination

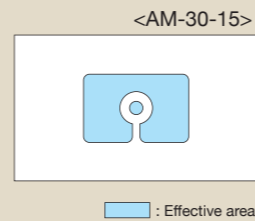
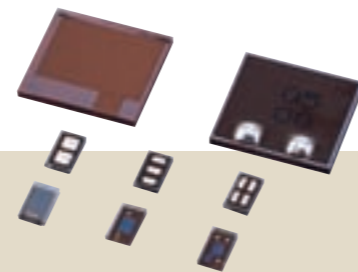

Amorphous Photosensor Pattern Shape Example

### High Sensitivity detection within the visible-light spectrum

Human eyes are sensitive to the light wavelength ranging from approximately 400nm to 700nm. Amorphous photosensors have sensitivity in the same range and provide light sensing capability similar to human eyes.

### Output current is proportional to illumination

Accurate light detection is possible because output current increases proportionally to the illuminance.

### Flexibility in pattern shaping or sizing

Amorphous photosensors provide flexible designing in size and shape to fit your needs.

## Amorton Photosensors Circuit Diagram Example

OP amplifier detects photosensor output current and convert to voltage. The signal is linearly amplified.

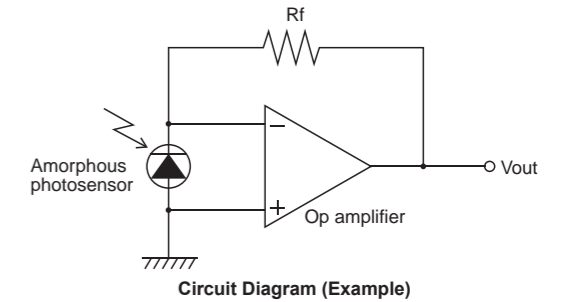

## Amorton Photosensors Application Example

The following shows typical applications of amorphous photosensors

Adjusting Luminosity LCD Back Light

- Cellular Phone
- Mobile Products
- Car Navigation

Exposure Control in Camera

System Lighting Control

- Street Light
- Garden Light

SANYO can support other applications as well. Contact your SANYO representative for consultation.

# Solar Cell Output and Light Sources

The output of solar cells differ depending on the categories of light sources to which they are exposed. This is because photoelectric conversion efficiency changes with respect to the wavelength and intensity of the light.

## 1. Categories of light sources

The general light source for solar cells is sunlight out of doors, and fluorescent or incandescent light indoors. The following outline describes the various categories:

Light source			
Sunlight		Artificial light	
AM-0	Outer space (solar light at global average revolution orbit)	Incandescent light	General-use incandescent light, halogen lamp
AM-1	When the sun is directly overhead (0m above sea level at the equator, vertical sunlight at meridian passage)	Fluorescent light	Daylight, white, and warm white colors
AM-1.5	When zenithal angle (Sunlight angle 0° when sun is directly overhead) is 48.2°.	Electric discharge lamp	Mercury-vapor lamp, sodium-vapor lamp, xenon lamp
Other	AM-2 (when zenithal angle is 60°), etc.		

## 2. Brightness

When sunlight and fluorescent light are compared in terms of brightness, the results are shown as follows:

[Light Source]	Sunlight	Fluorescent light	
Condition	Illuminance (lux)	Condition	Illuminance (lux)
Direct sun	100,000 to 120,000	Design stand (partially illuminated)	Around 1,000
Bright	50,000 to 100,000	Office/conference room	300 to 600
Cloudy	10,000 to 50,000	Restaurants/coffee shops	Below 200
Rain	5,000 to 20,000		



## 3. Radiant spectrum of light source and spectral sensitivity of solar cells

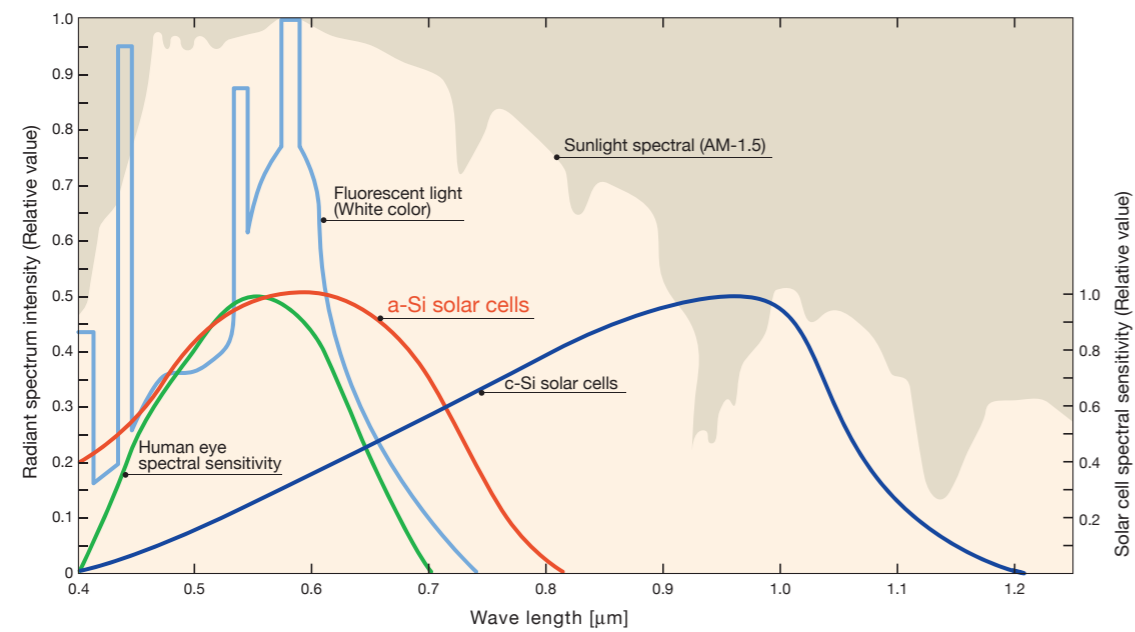

## Precautions in Handling Amorton and Amorphous Photosensors



Do not scratch the rear surface with a hard object because it could damage amorphous silicon (1 $\mu$ m thick active layer) and causes electrical malfunction even though the surface is protected by resin coating.



Be careful not to get injured with the sharp edges of the substrate material (glass or stainless steel).



Employ robust and airtight encapsulation when the cell is expected to receive mechanical shocks by falling objects or exposed to harsh weather conditions. Note shattered glass pieces can cause injury and humid environment can damage the cell.



Avoid touching the cell in the daytime because you may get burned with heat particularly when the insolation is strong.



Do not touch the light-receiving side with bare hands because it stains the surface and affect electrical output.



Static electricity can damage the cell. As it deemed necessary, consider a proper method to remove static electricity.



Store in cool, low-humid environment without corrosive gas to avoid possible damages to the cell.



Consider fail-safe or proximity in your product design.

- Any and all SANYO Semiconductor Co.,Ltd. products described or contained herein are, with regard to "standard application", intended for the use as general electronics equipment (home appliances, AV equipment, communication device, office equipment, industrial equipment etc.). The products mentioned herein shall not be intended for use for any "special application" (medical equipment whose purpose is to sustain life, aerospace instrument, nuclear control device, burning appliances, transportation machine, traffic signal system, safety equipment etc.) that shall require extremely high level of reliability and can directly threaten human lives in case of failure or malfunction of the product or may cause harm to human bodies, nor shall they grant any guarantee thereof. If you should intend to use our products for applications outside the standard applications of our customer who is considering such use and/or outside the scope of our intended standard applications, please consult with us prior to the intended use. If there is no consultation or inquiry before the intended use, our customer shall be solely responsible for the use.
- Specifications of any and all SANYO Semiconductor Co.,Ltd. products described or contained herein stipulate the performance, characteristics, and functions of the described products in the independent state, and are not guarantees of the performance, characteristics, and functions of the described products as mounted in the customer's products or equipment. To verify symptoms and states that cannot be evaluated in an independent device, the customer should always evaluate and test devices mounted in the customer's products or equipment.
- SANYO Semiconductor Co.,Ltd. assumes no responsibility for equipment failures that result from using products at values that exceed, even momentarily, rated values (such as maximum ratings, operating condition ranges, or other parameters) listed in products specifications of any and all SANYO Semiconductor Co.,Ltd. products described or contained herein.
- SANYO Semiconductor Co.,Ltd. strives to supply high-quality high-reliability products, however, any and all semiconductor products fail or malfunction with some probability. It is possible that these probabilistic failures or malfunction could give rise to accidents or events that could endanger human lives, trouble that could give rise to smoke or fire, or accidents that could cause damage to other property. When designing equipment, adopt safety measures so that these kinds of accidents or events cannot occur. Such measures include but are not limited to protective circuits and error prevention circuits for safe design, redundant design, and structural design.
- In the event that any or all SANYO Semiconductor Co.,Ltd. products described or contained herein are controlled under any of applicable local export control laws and regulations, such products may require the export license from the authorities concerned in accordance with the above law.
- No part of this publication may be reproduced or transmitted in any form or by any means, electronic or mechanical, including photocopying and recording, or any information storage or retrieval system, or otherwise, without the prior written consent of SANYO Semiconductor Co.,Ltd.
- Any and all information described or contained herein are subject to change without notice due to product/technology improvement, etc. When designing equipment, refer to the "Delivery Specification" for the SANYO Semiconductor Co.,Ltd. product that you intend to use.
- Information (including circuit diagrams and circuit parameters) herein is for example only; it is not guaranteed for volume production.
- Upon using the technical information or products described herein, neither warranty nor license shall be granted with regard to intellectual property rights or any other rights of SANYO Semiconductor Co.,Ltd. or any third party. SANYO Semiconductor Co.,Ltd. shall not be liable for any claim or suits with regard to a third party's intellectual property rights which has resulted from the use of the technical information and products mentioned above.



## X-ON Electronics

Largest Supplier of Electrical and Electronic Components

*Click to view similar products for [Solar Panels & Solar Cells](#) category:*

*Click to view products by [Panasonic](#) manufacturer:*

Other Similar products are found below :

[AM-1606C-MEL](#) [200](#) [2747](#) [SC10050](#) [FIT0601](#) [SC20072](#) [SC20050](#) [FIT0333](#) [SC20036](#) [SC10036](#) [AM-1513CA](#) [AM-1719CA](#) [AM-1805CA](#)  
[AM-1820CA](#) [500](#) [1525](#) [3809](#) [MIKROE-651](#) [AM-1417CA](#) [AM-1454CA](#) [AM-1456CA](#) [AM-1801CA](#) [AM-1815CA](#) [AM-1816CA](#) [AM-](#)  
[1819CA](#) [AM-5608CAR](#) [AM-5610CAR](#) [AM-5706CAR](#) [AM-5902CAR](#) [AM-5904CAR](#) [AM-8702CAR](#) [AT-7665A](#) [LL200-2.4-75](#) [LL200-3-](#)  
[37](#) [LL200-3.6-75](#) [LL200-4.8-37](#) [MP3-25](#) [MP3-37](#) [MP7.2-150F](#) [MP7.2-75F](#) [MPT15-150](#) [MPT15-75](#) [MPT3.6-150](#) [MPT3.6-75](#) [MPT4.8-150](#)  
[MPT4.8-75](#) [MPT6-150](#) [MPT6-75](#) [P7.2-150F](#) [P7.2-75F](#)