

Model : AM-5610CAR

1. Outside dimensions 外形寸法

Light Receiving Side (受光面)

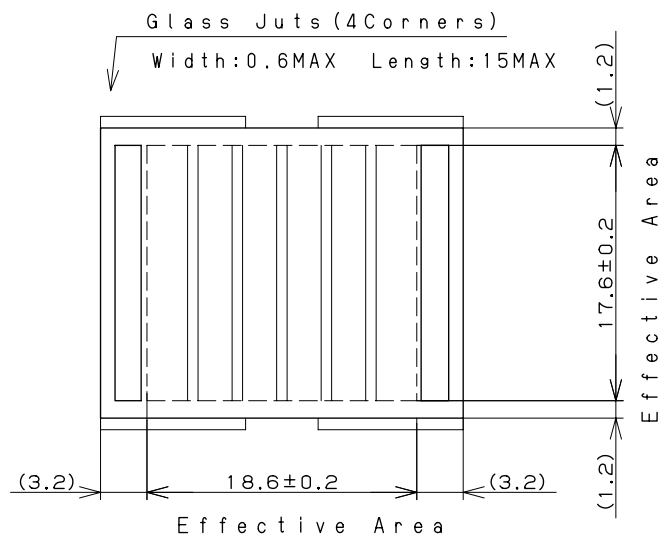

Overcoat Side (オーバーコート面)

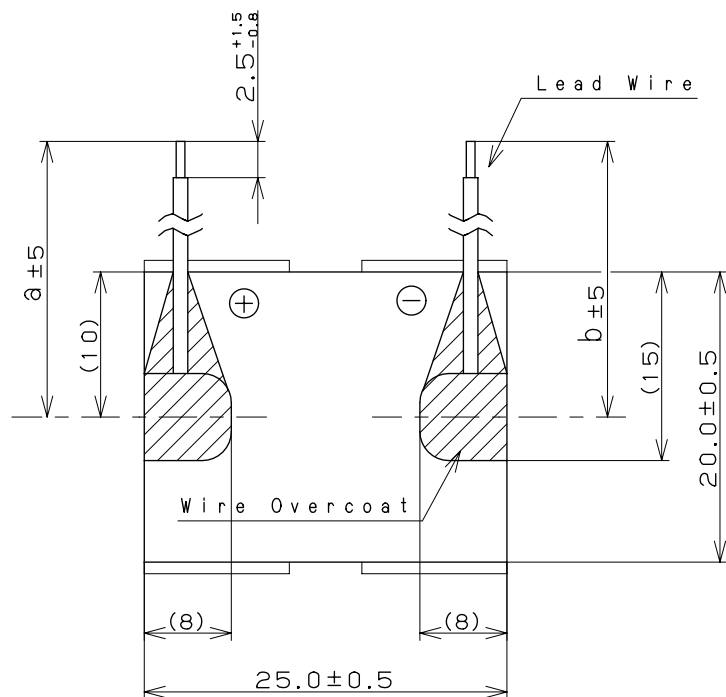

(dimension:mm)

Lead Wires : AWG30	
a : 70	b : 70

Note

Glass Substrate Thickness (ガラス基板厚) : 1.8mm±0.2
 Module Thickness (モジュール厚) : 2.2mmMAX
 Wire-Overcoat Thickness : 3.3mmMAX (including Module)
 (リード線補正コート厚)

2. Rated Specifications (at 25°C)

Item	Specifications (Initial)		
2.1 Open circuit voltage: Voc 開放電圧	Typical	5.1V	at 50kLx SS
2.2 Short circuit Current: Isc 短絡電流	Typical	2.4mA	at 50kLx SS
2.3 Operating Voltage & Operating Current: Vope-Iope 動作特性	Minimum	3.0V - 1.7mA	at 50kLx SS
	Typical	3.3V - 2.3mA	at 50kLx SS
	Typical	3.3V - 5.1mA	at AM-1.5 100mW/cm ²
2.4 Maximum output: Pmax & optimum operating Volt: Vop optimum operating Current: Iop 最大出力	(reference)	8mW	Vop=3.9V Iop=2.2mA at 50kLx SS
	(reference)	18mW	Vop=3.9V Iop=4.6mA at AM-1.5 100mW/cm ²
2.5 Working temperature range: Topr 動作温度範囲	-10 to 60°C		
2.6 Storage temperature range: Tstg 保存温度範囲	-20 to 70°C		

SS: Solar Simulator

I - V Characteristics

REFERENCE

1.Model : AM-5610

2.Outside Dimension : 25.0mm × 20.0mm

SS:Solar Simulator

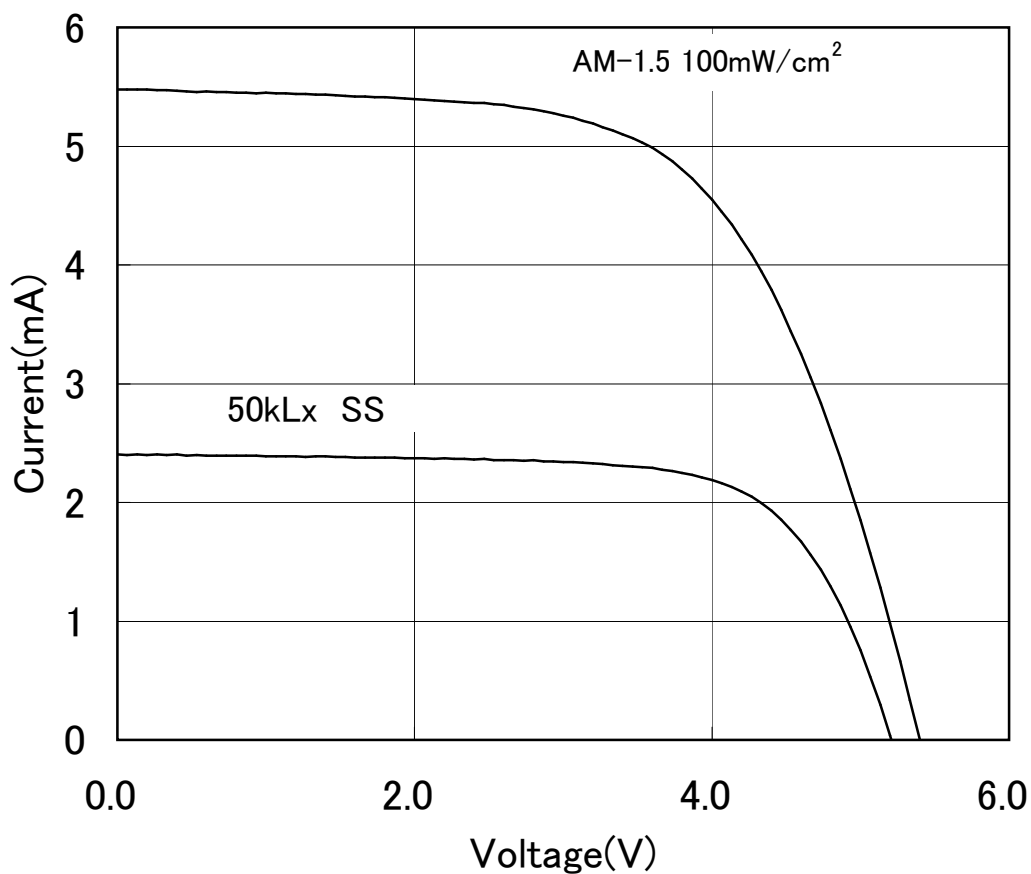

*このデータは標準的な出力特性を示すものであり、特性を保証するものではありません。

*The data are meant to show standard electric characteristics only , not intended to guarantee the characteristics.

Panasonic Eco Solutions Amorton Co.,Ltd.

2014/1/10

出力の照度依存特性

REFERENCE

Dependence of Output on Illumination

1.Model : AM-5610

2.Outside Dimension : 25.0mm × 20.0mm

SS:Solar Simulator

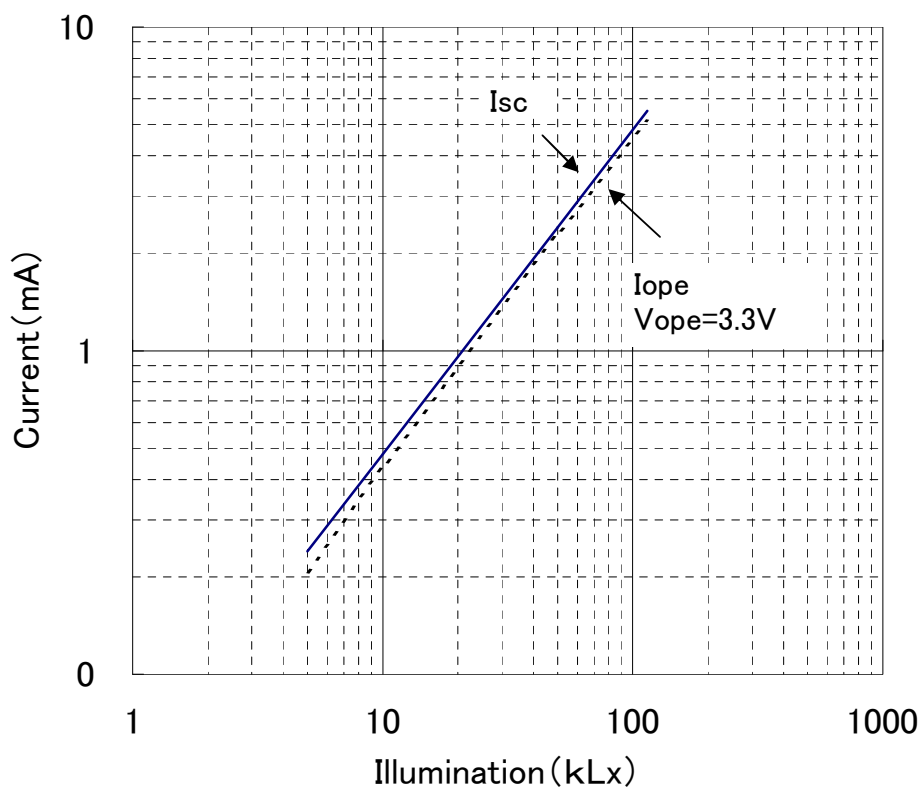
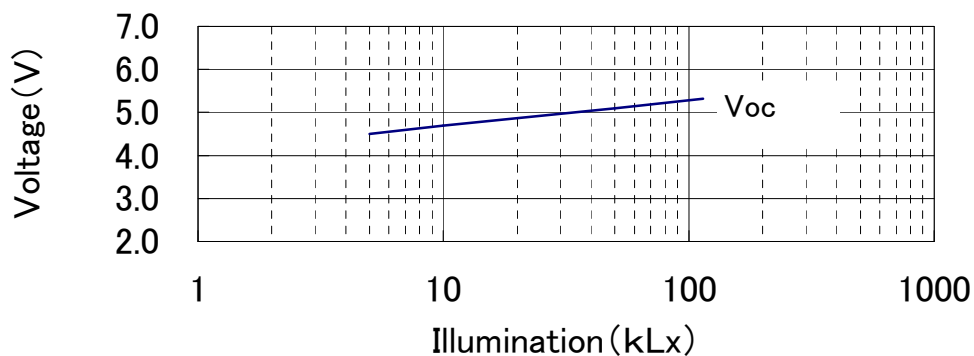

*このデータは標準的な出力特性を示すものであり、特性を保証するものではありません。

*The data are meant to show standard electric characteristics only , not intended to guarantee the characteristics.

出力の温度依存特性

REFERENCE

Dependence of Output on Temperature

1.Model : AM-5610

2.Outside Dimension : 25.0mm × 20.0mm

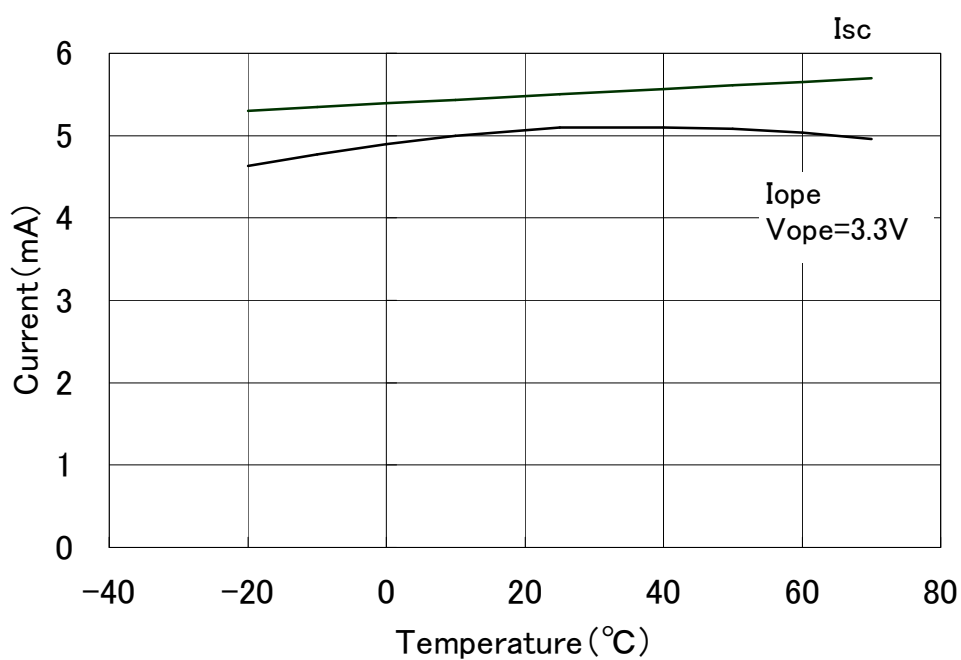
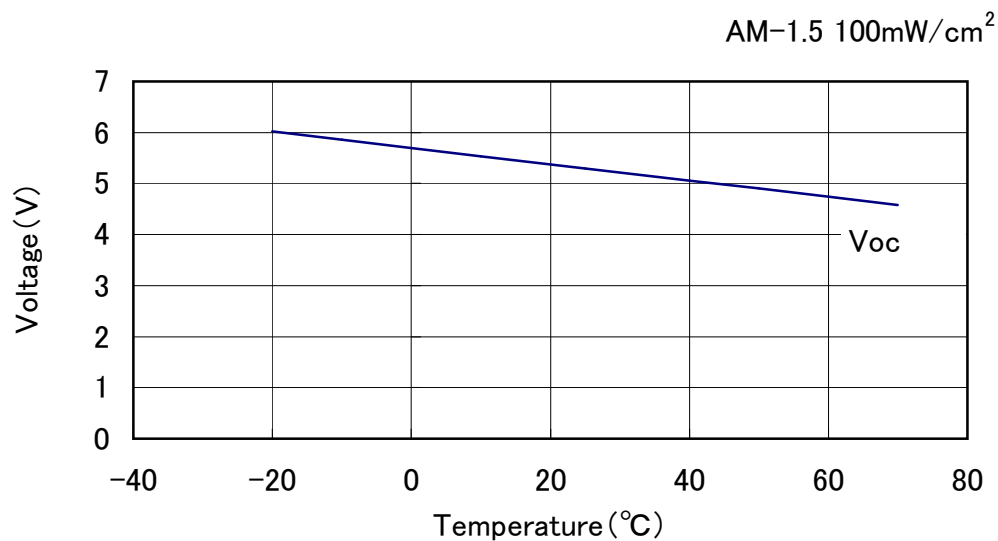

*このデータは標準的な出力特性を示すものであり、特性を保証するものではありません。

*The data are meant to show standard electric characteristics only , not intended to guarantee the characteristics.

X-ON Electronics

Largest Supplier of Electrical and Electronic Components

Click to view similar products for [Solar Panels & Solar Cells](#) category:

Click to view products by [Panasonic](#) manufacturer:

Other Similar products are found below :

[AM-1606C-MEL](#) [200](#) [2747](#) [SC10050](#) [FIT0601](#) [SC20072](#) [SC20050](#) [FIT0333](#) [SC20036](#) [SC10036](#) [AM-1513CA](#) [AM-1719CA](#) [AM-1805CA](#)
[AM-1820CA](#) [500](#) [1525](#) [3809](#) [MIKROE-651](#) [AM-1417CA](#) [AM-1454CA](#) [AM-1456CA](#) [AM-1801CA](#) [AM-1815CA](#) [AM-1816CA](#) [AM-](#)
[1819CA](#) [AM-5608CAR](#) [AM-5610CAR](#) [AM-5706CAR](#) [AM-5902CAR](#) [AM-5904CAR](#) [AM-8702CAR](#) [AT-7665A](#) [LL200-2.4-75](#) [LL200-3-](#)
[37](#) [LL200-3.6-75](#) [LL200-4.8-37](#) [MP3-25](#) [MP3-37](#) [MP7.2-150F](#) [MP7.2-75F](#) [MPT15-150](#) [MPT15-75](#) [MPT3.6-150](#) [MPT3.6-75](#) [MPT4.8-150](#)
[MPT4.8-75](#) [MPT6-150](#) [MPT6-75](#) [P7.2-150F](#) [P7.2-75F](#)