

# DATA SHEET

Part No.	AN77L09
Package Code No.	SSIP003-P-0000S (Exclusive use for AN77Lxx)

## Contents

■ Overview .....	3
■ Features .....	3
■ Applications .....	3
■ Package .....	3
■ Type .....	3
■ Block Diagram .....	4
■ Pin Descriptions .....	5
■ Absolute Maximum Ratings .....	6
■ Operating supply voltage range .....	6
■ Electrical Characteristics .....	7
■ Electrical Characteristics (Reference values for design) .....	8
■ Technical Data .....	9
■ Package Dimensions .....	10
■ Usage Notes .....	11

# AN77L09

## 3-pin, positive output, low dropout voltage regulator (100 mA type)

### ■ Overview

The AN77Lxx series are 3-pin, fixed positive output type monolithic voltage regulators. The AN77L09 is the 9 V output voltage type in these series. They can be used widely in power supply circuits with current capacity of up to 100 mA. It is suitable for the low-voltage equipment using batteries and consumer/industrial equipment with great fluctuation of the supply voltage.

Stabilized fixed output voltage is obtained from unstable DC input voltage with using a 10  $\mu$ F output capacitor.

11 types of fixed output voltage are available; 3 V, 3.5 V, 4 V, 4.5 V, 5 V, 6 V, 7 V, 8 V, 9 V, 10 V and 12 V.

### ■ Features

- Minimum input/output voltage difference: 0.28 V typ.
- Built-in over current limit circuit
- Built-in rush current prevention circuit at input voltage rise
- Built-in overheat protection circuit
- Built-in input short-circuit protection circuit

### ■ Applications

- 3-pin positive output voltage regulator (100 mA type)

### ■ Package

- 3-pin plastic shrink single inline package (SSIP type)

### ■ Type

- Silicon monolithic bipolar IC

■ Block Diagram

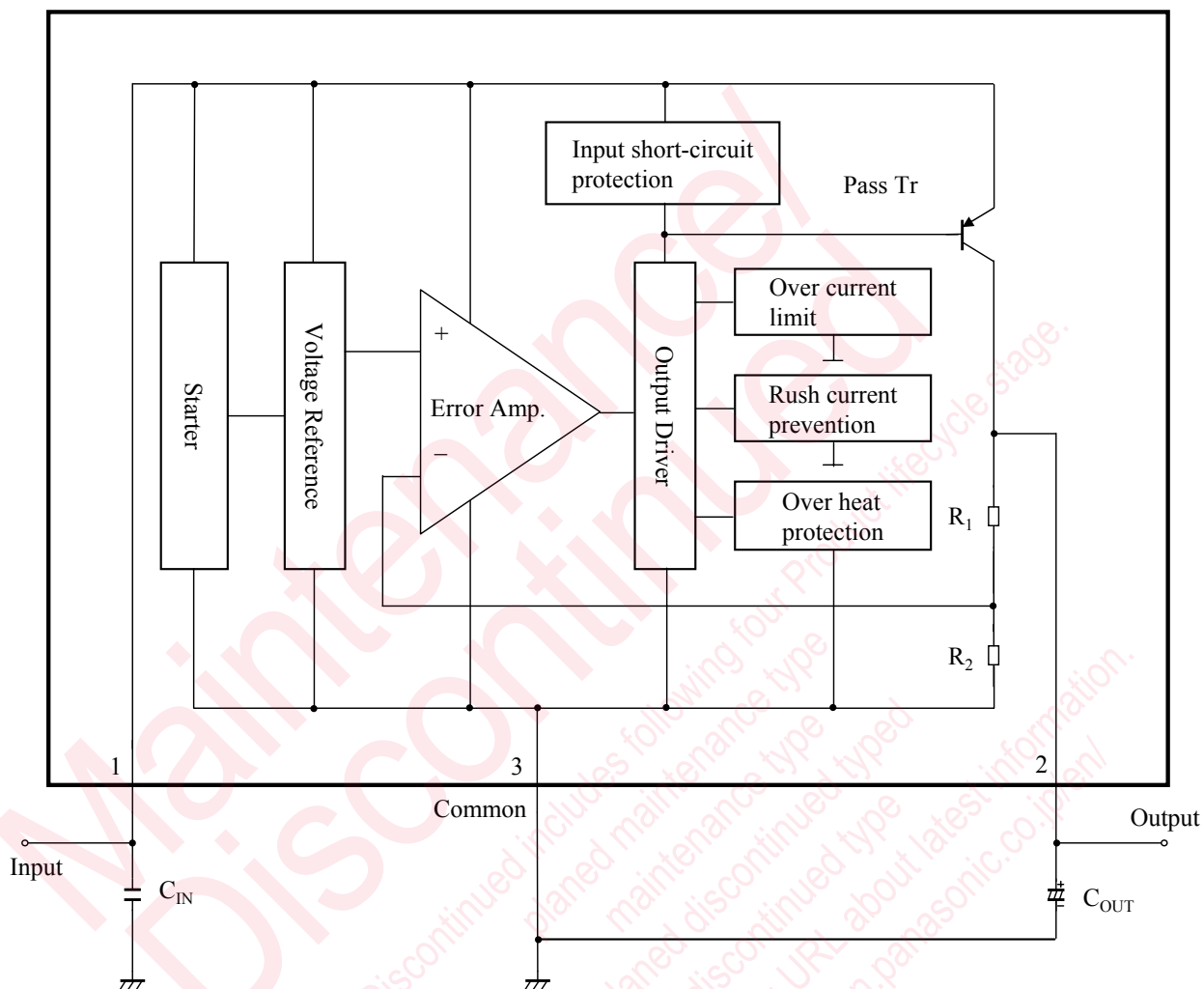

$C_{IN}$  : 0.33  $\mu$ F

$C_{OUT}$  : 10  $\mu$ F

$R_1$  : 31 k $\Omega$

$R_2$  : 5 k $\Omega$

## ■ Pin Descriptions

Pin No.	Pin name	Type	Description
1	Input	Input	Input voltage
2	Output	Output	Output voltage
3	Common	GND	Ground.

Maintenance/Discontinued

Maintenance/Discontinued includes four Product lifecycle stage.  
planned maintenance type  
maintenance type  
planned discontinued type  
discontinued type

Please visit following URL about latest information.  
<http://www.semicon.panasonic.co.jp/en/>

### ■ Absolute Maximum Ratings

A No.	Parameter	Symbol	Rating	Unit	Note
1	Input voltage	$V_{IN}$	30	V	*1
2	Supply current	$I_{CC}$	200	mA	—
3	Power dissipation	$P_D$	342	mW	*2
4	Operating ambient temperature	$T_{opr}$	-30 to +85	°C	*3
5	Storage temperature	$T_{stg}$	-55 to +150	°C	*3

Note) \*1: The values under the condition not exceeding the above absolute maximum ratings and the power dissipation.

\*2: The power dissipation shown is the value at  $T_a = 85^\circ\text{C}$ .

When using this IC, refer to the •  $P_D$ - $T_a$  diagram in the ■ Technical Data and use under the condition not exceeding the allowable value.

When  $T_j$  exceeds  $150^\circ\text{C}$ , the internal circuit cuts off the output.

\*3: Except for the power dissipation, operating ambient temperature, and storage temperature, all ratings are for  $T_a = 25^\circ\text{C}$ .

### ■ Operating supply voltage range

Parameter	Symbol	Range	Unit	Note
Supply voltage range	$V_{CC}$	( $V_{OUT} 0.53\text{ V}$ ) to 19.86	V	—

Note) The values under the condition not exceeding the above absolute maximum ratings and the power dissipation.

### ■ Electrical Characteristics

Note) Unless otherwise specified,  $T_a = 25^\circ\text{C} \pm 2^\circ\text{C}$ ,  $V_{\text{IN}} = 9\text{ V}$ ,  $I_{\text{OUT}} = 50\text{ mA}$ ,  $C_{\text{IN}} = 0.33\text{ }\mu\text{F}$  and  $C_{\text{OUT}} = 10\text{ }\mu\text{F}$ .

B No.	Parameter	Symbol	Conditions	Limits			Unit	Note
				Min	Typ	Max		
1	Output voltage	$V_{\text{OUT}}$	—	8.64	9.0	9.36	V	—
2	Line regulation	$\text{REG}_{\text{IN}}$	$V_{\text{IN}} = 9.86\text{ V to } 19.86\text{ V}$	—	6.0	90	mV	—
3	Load regulation	$\text{REG}_{\text{L}}$	$I_{\text{OUT}} = 0\text{ mA to } 100\text{ mA}$	—	13	90	mV	—
4	Minimum input/output voltage difference 1	$V_{\text{DIF}(\text{min})1}$	$V_{\text{IN}} = 8.1\text{ V}, I_{\text{OUT}} = 50\text{ mA}$	—	0.13	0.25	V	—
5	Minimum input/output voltage difference 2	$V_{\text{DIF}(\text{min})2}$	$V_{\text{IN}} = 8.1\text{ V}, I_{\text{OUT}} = 100\text{ mA}$	—	0.28	0.53	V	—
6	Bias current before regulation start	$I_{\text{rush}}$	$V_{\text{IN}} = 8.1\text{ V}, I_{\text{OUT}} = 0\text{ mA}$	—	1.5	5	mA	—
7	Bias current	$I_{\text{Bias}}$	$I_{\text{OUT}} = 0\text{ mA}$	—	1.2	1.7	mA	—
8	Bias current fluctuation to load	$\Delta I_{\text{Bias(L)}}$	$I_{\text{OUT}} = 0\text{ mA to } 100\text{ mA}$	—	3.0	5	mA	—
9	Ripple rejection ratio	RR	$V_{\text{IN}} = 9.86\text{ V to } 11.86\text{ V},$ $f = 120\text{ Hz}$	52	62	—	dB	—

### ■ Electrical Characteristics (Reference values for design)

Note) Unless otherwise specified,  $T_a = 25^\circ\text{C} \pm 2^\circ\text{C}$ ,  $C_{IN} = 0.33 \mu\text{F}$  and  $C_{OUT} = 10 \mu\text{F}$ .

The characteristics listed below are reference values for design of the IC and are not guaranteed by inspection.

If a problem does occur related to these characteristics, Panasonic will respond in good faith to user concerns.

B No.	Parameter	Symbol	Conditions	Reference values			Unit	Note
				Min	Typ	Max		
1	Output noise voltage	$V_{no}$	$V_{IN} = 10 \text{ V}$ , $I_{OUT} = 50 \text{ mA}$ $f = 10 \text{ Hz to } 100 \text{ kHz}$	—	150	—	$\mu\text{V}$	—
2	Over heat protection temperature start	$T_{j(TH)}$	$V_{IN} = 10 \text{ V}$	—	150	—	$^\circ\text{C}$	—
3	Output voltage temperature coefficient	$\frac{\Delta V_{OUT}}{T_a}$	$V_{IN} = 10 \text{ V}$ $T_j = -30^\circ\text{C to } 125^\circ\text{C}$	—	0.60	—	$\text{mV}/^\circ\text{C}$	—



- Technical Data
- $P_D - T_a$  diagram

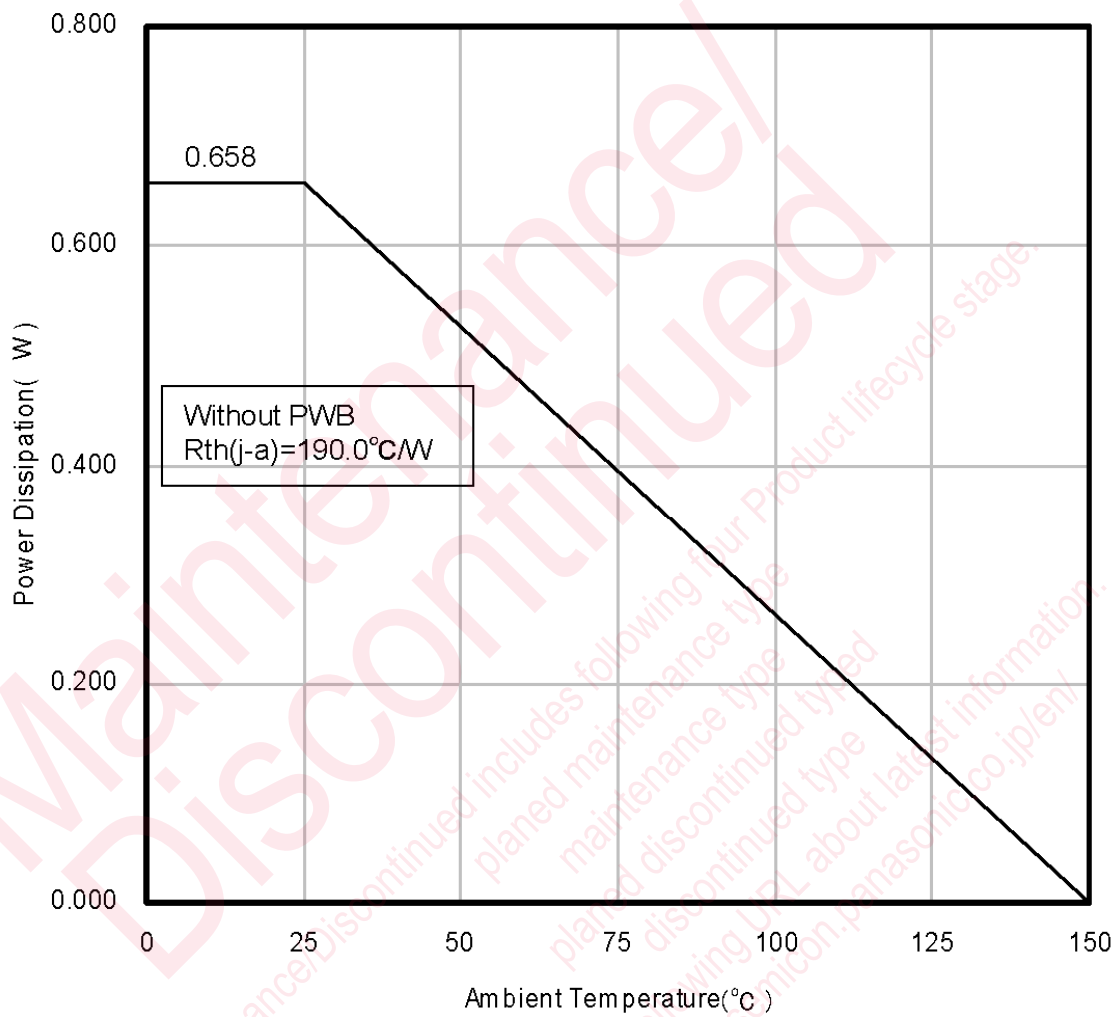

## ■ Package Dimensions (Unit: mm)

- SSIP003-P-0000S (Exclusive use for AN77Lxx)

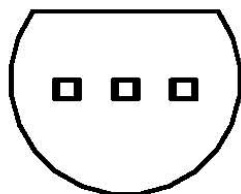
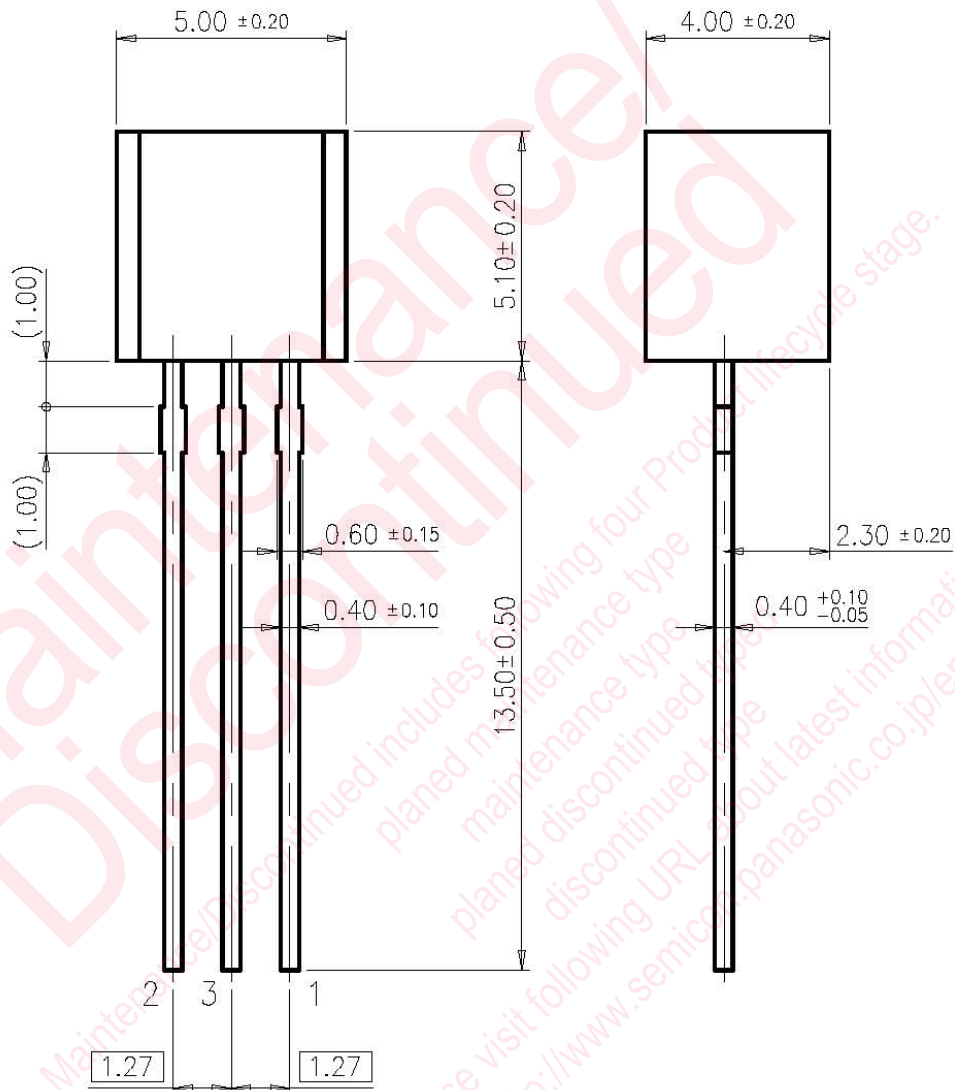

## ■ Usage Notes

### 1. Input short-circuit protection circuit

For the conventional Panasonic 3-pin regulators (such as of the AN80xx series), when DC input pin (pin 1) is short-circuited with GND pin (pin 3) in the normal operation condition, the potential of output pin (pin 2) becomes higher than that of DC input pin and the electric charges which is charged in output capacitor  $C_{OUT}$  flows in the input side, having resulted in the breakage of elements.

In the above case, the common silicon diode is connected as shown in the following figure (the dotted line).

However, for the AN77Lxx/AN77LxxM series, since the protection circuit, which protects the elements from the discharging current, is incorporated in the internal circuit, the protection diode is not required.

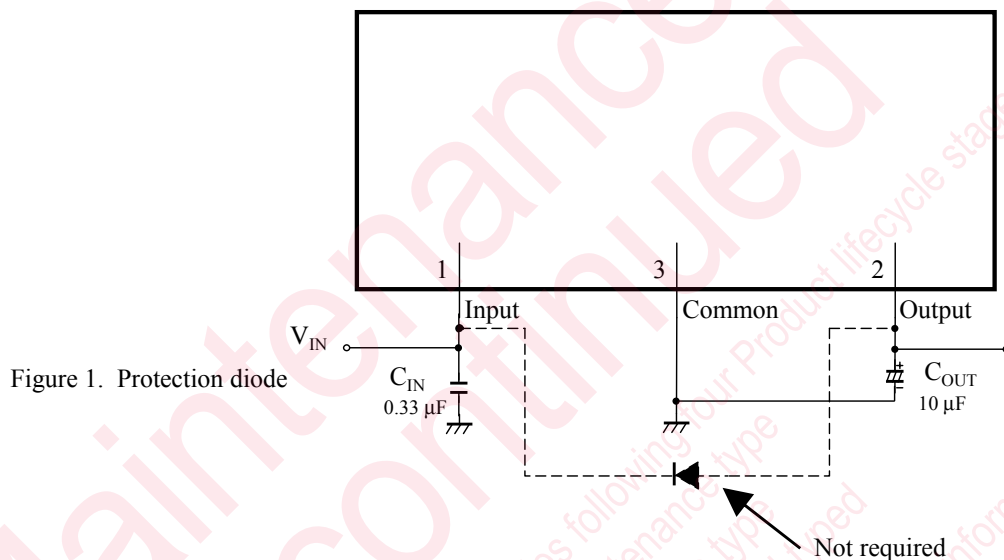

Figure 1. Protection diode

### 2. Short-circuit between the output pin and the GND pin

Because there is no in-built protection circuit in the AN77Lxx/AN77LxxM series, they have the drooping characteristics as shown in "Figure 3". When your use under a high voltage happens to cause any short-circuit between the output pin (pin 2) and the GND pin (pin 3), the IC is likely to be broken.

### 3. Capacitor for external compensation

In order to secure the stability, the capacitor of 10  $\mu\text{F}$  is required in the output side and it should be added as near to output pin (pin 2) and GND pin (pin 3) as possible. When it is used under low temperature, oscillation may occur due to the decrease of the aluminum electrolytic capacitor's capacitance and an increase of ESR. For the AN77Lxx series, it is recommended that the tantalum capacitor or aluminum electrolytic capacitor whose equivalent serial resistance with temperature characteristics within the recommended range specified in "Figure 2" should be used.

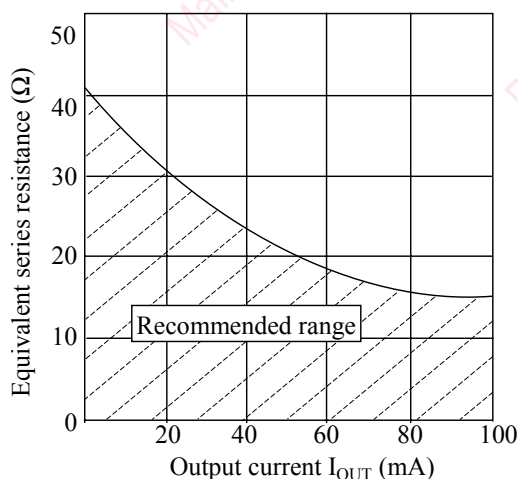

Figure 2. ESR recommended range

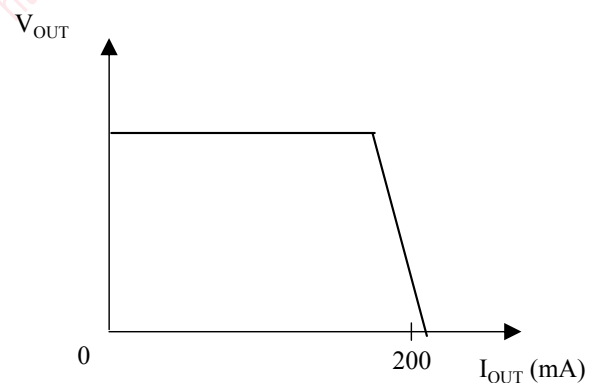

Figure 3. Over current limit control

## Request for your special attention and precautions in using the technical information and semiconductors described in this book

- (1) If any of the products or technical information described in this book is to be exported or provided to non-residents, the laws and regulations of the exporting country, especially, those with regard to security export control, must be observed.
- (2) The technical information described in this book is intended only to show the main characteristics and application circuit examples of the products. No license is granted in and to any intellectual property right or other right owned by Panasonic Corporation or any other company. Therefore, no responsibility is assumed by our company as to the infringement upon any such right owned by any other company which may arise as a result of the use of technical information described in this book.
- (3) The products described in this book are intended to be used for standard applications or general electronic equipment (such as office equipment, communications equipment, measuring instruments and household appliances).  
Consult our sales staff in advance for information on the following applications:
  - Special applications (such as for airplanes, aerospace, automobiles, traffic control equipment, combustion equipment, life support systems and safety devices) in which exceptional quality and reliability are required, or if the failure or malfunction of the products may directly jeopardize life or harm the human body.
  - Any applications other than the standard applications intended.
- (4) The products and product specifications described in this book are subject to change without notice for modification and/or improvement. At the final stage of your design, purchasing, or use of the products, therefore, ask for the most up-to-date Product Standards in advance to make sure that the latest specifications satisfy your requirements.
- (5) When designing your equipment, comply with the range of absolute maximum rating and the guaranteed operating conditions (operating power supply voltage and operating environment etc.). Especially, please be careful not to exceed the range of absolute maximum rating on the transient state, such as power-on, power-off and mode-switching. Otherwise, we will not be liable for any defect which may arise later in your equipment.
  - Even when the products are used within the guaranteed values, take into the consideration of incidence of break down and failure mode, possible to occur to semiconductor products. Measures on the systems such as redundant design, arresting the spread of fire or preventing glitch are recommended in order to prevent physical injury, fire, social damages, for example, by using the products.
- (6) Comply with the instructions for use in order to prevent breakdown and characteristics change due to external factors (ESD, EOS, thermal stress and mechanical stress) at the time of handling, mounting or at customer's process. When using products for which damp-proof packing is required, satisfy the conditions, such as shelf life and the elapsed time since first opening the packages.
- (7) This book may be not reprinted or reproduced whether wholly or partially, without the prior written permission of our company.

## X-ON Electronics

Largest Supplier of Electrical and Electronic Components

*Click to view similar products for [panasonic](#) manufacturer:*

Other Similar products are found below :

[ECE-A1HKAR47](#) [ELC-09D151F](#) [HC2-H-DC48V-F](#) [HL2-HP-AC120V-F](#) [HL2-H-DC12V-F](#) [HL2-HP-DC12V-F](#) [HL2-HP-DC6V-F](#) [HL2-HP-DC24V-F](#) [HL2-H-DC110V-F](#) [HC4-H-DC24V](#) [HL2-HTM-DC24V-F](#) [HL2-HTM-AC24V-F](#) [HC4-H-AC24V](#) [HC4-H-AC120V](#) [HC4-H-DC12V](#) [AZH2031](#) [RP-SDMF64DA1](#) [EVM-F6SA00B55](#) [RP-SMLE08DA1](#) [ERZ-V20R391](#) [ELL-ATV681M](#) [ERZ-V05V680CB](#) [LT4H-DC24V](#) [LT4HL8-AC24V](#) [LT4HW-AC24V](#) [LT4HWT8-AC240V](#) [LT4HWT-AC240VS](#) [CY-122A-P](#) [ETQ-P5M470YFM](#) [EVAL\\_PAN1555](#) [EVQ-PAE04M](#) [EX-14B](#) [EX-22B-PN](#) [EX-31A-C5](#) [EXB-24N121JX](#) [EX-F72-PN](#) [EX-L211](#) [EYG-A121803V](#) [FCR-M50-AC208V](#) [FC-SFBH-20](#) [FC-SFBH-24](#) [FD-F8Y](#) [MHMA102A1C](#) [MHMD022S1S](#) [MHMD041S1S](#) [MHMD042G1T](#) [MHMD082G1T](#) [FD-S9](#) [FP0-LDR](#) [FP2-AD8X](#)