

**Super miniature  
TSON package,  
Capacitor Coupled  
isolation**

**PhotoMOS®  
CC TSON C×R  
(AQY2C○○○P)**

**New**

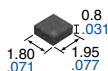

mm inch

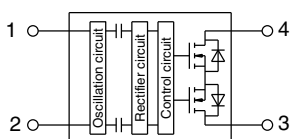

**RoHS compliant**

## FEATURES

1. Super miniature TSON package contributes to space savings and high density mounting. 3.5 mm<sup>2</sup> mounting area achieved. Approx. 46 % less than previous product (SON type).

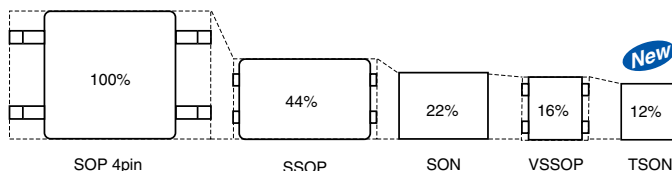

2. Low current consumption (input current: Max. 0.2 mA)
3. Guaranteed performance at high temperature (Max. 105°C 221°F)
4. Voltage driving type (3 V to 5 V)
5. Low on resistance and low output capacitance available
6. Input current of CC type is less than half of previous products, contributing energy saving of device and increases drivability

Comparison with previous products

		CC type (AQY2C1R2P)	HS type (AQY232S)	GU type (AQY212S)
Input current/ LED current	Minimum	–	2 mA*2	5 mA*2
	Typical	0.09 mA*1	–	
	Maximum	0.2 mA*1	30 mA*2	

Notes: \*1.  $V_{IN} = 5 V$

\*2. Recommend operating condition.

## TYPICAL APPLICATIONS

1. Measuring equipment: IC tester, probe cards, board tester and other testing equipment
2. Telecommunication equipment
3. Security, voltage operating equipment application for requiring low electricity consumption.
  - Security equipment: Security camera, intruder detection
  - Disaster-preventing equipment: Fire alarm, smoke, heat and fire detectors
  - Industrial equipment: Electric measuring equipment, Industrial measuring equipment
  - Electric meter, Gas meter and other meters.

\*Does not support automotive application.

## TYPES

Type		Output rating*1		Part No. (Tape and reel packing style)*2		Packing quantity in the tape and reel
		Load voltage	Load current	Picked from the 1 and 2-pin side	Picked from the 3 and 4-pin side	
AC/DC dual use	Low on resistance	30 V	0.75 A	<b>AQY2C1R6PX</b>	<b>AQY2C1R6PZ</b>	3,500 pcs.
		40 V	0.3 A	<b>AQY2C1R2PX</b>	<b>AQY2C1R2PZ</b>	
		<b>New</b> 60 V	0.3 A	<b>AQY2C2R2PX</b>	<b>AQY2C2R2PZ</b>	
	Low output capacitance	<b>New</b> 40 V	0.1 A	<b>AQY2C1R3PX</b>	<b>AQY2C1R3PZ</b>	
		<b>New</b> 100 V	0.12 A	<b>AQY2C5R3PX</b>	<b>AQY2C5R3PZ</b>	

Notes: \*1. Indicate the peak AC and DC values.

\*2. Only tape and reel package is available.

For space reasons, only "1R6", "1R2", "2R2", "1R3" or "5R3" is marked on the product as the part number.

## RATING

### 1. Absolute maximum ratings (Ambient temperature: 25°C 77°F)

Item	Symbol	Low on resistance			Low output capacitance		Remarks	
		AQY2C1R6P	AQY2C1R2P	AQY2C2R2P	AQY2C1R3P	AQY2C5R3P		
Input side	Input voltage	$V_{IN}$	5.5 V					
	Input reverse voltage	$V_{RIN}$	0.2 V					
	Power dissipation	$P_{in}$	1.2 mW					
Output side	Load voltage (peak AC)	$V_L$	30 V	40 V	60 V	40 V	100 V	
	Continuous load current	$I_L$	0.75 A	0.3 A	0.3 A	0.1 A	0.12 A	Peak AC, DC
	Peak load current	$I_{peak}$	1.5 A	0.75 A	0.9 A	0.3 A	0.3 A	100 ms (1shot), $V_L = DC$
	Power dissipation	$P_{out}$	250 mW					
Total power dissipation	$P_T$	250 mW						
I/O isolation voltage	$V_{iso}$	200 Vrms						
Ambient temperature	Operating	$T_{opr}$	-40 to +105°C -40 to +221°F				(Non-icing at low temperatures)	
	Storage	$T_{stg}$	-40 to +125°C -40 to +257°F					

### 2. Electrical characteristics (Ambient temperature: 25°C 77°F)

Item	Symbol	Low on resistance			Low output capacitance		Condition			
		AQY2C1R6P	AQY2C1R2P	AQY2C2R2P	AQY2C1R3P	AQY2C5R3P				
Input	Operate voltage	Typ.	1.7 V	1.8 V	1.7 V	2.2 V	2.0 V	$\Delta V_{IN} / \Delta t \geq 100$ mV/ms AQY2C1R6P: $I_L = 100$ mA AQY2C1R2P: $I_L = 300$ mA AQY2C2R2P: $I_L = 300$ mA AQY2C1R3P: $I_L = 80$ mA AQY2C5R3P: $I_L = 80$ mA		
		Max.	2.5 V							
	Turn off voltage	Min.	0.5 V							
		Typ.	1.5 V	1.4 V		1.5 V				
Input current	Typ.	$I_{IN}$	0.04 mA				$V_{IN} = 3.3$ V			
			0.1 mA							
	Max.		0.09 mA				$V_{IN} = 5$ V			
			0.2 mA							
Output	On resistance	$R_{on}$	Typ.	0.22 $\Omega$	0.9 $\Omega$	1 $\Omega$	12.5 $\Omega$	9.5 $\Omega$	AQY2C1R6P: $V_{IN} = 3.3$ V, $I_L = 750$ mA AQY2C1R2P: $V_{IN} = 3.3$ V, $I_L = 300$ mA AQY2C2R2P: $V_{IN} = 3.3$ V, $I_L = 300$ mA AQY2C1R3P: $V_{IN} = 3.3$ V, $I_L = 80$ mA AQY2C5R3P: $V_{IN} = 3.3$ V, $I_L = 80$ mA Within 1 s on time	
			Max.	—	—	—	—	—		
			Typ.	0.2 $\Omega$	0.8 $\Omega$	0.9 $\Omega$	10.5 $\Omega$	9 $\Omega$		
			Max.	0.4 $\Omega$	1.5 $\Omega$		15 $\Omega$	14 $\Omega$		
Output capacitance	Typ.	$C_{out}$	40 pF	14.5 pF	27 pF	1.2 pF	5.8 pF	$V_{IN} = 0$ V, $f = 1$ MHz, $V_B = 0$ V		
	Max.		100 pF	18 pF	40 pF	2 pF	8 pF			
Off state leakage current	Max.	$I_{Leak}$	10 nA				$V_{IN} = 0$ V, $V_L = Max.$			
Transfer characteristics	Turn on time*	$T_{on}$	Typ.	0.25 ms	0.15 ms	0.18 ms	0.02 ms	0.06 ms	AQY2C1R6P: $V_{IN} = 3.3$ V, $V_L = 10$ V, $R_L = 100$ $\Omega$ AQY2C1R2P: $V_{IN} = 3.3$ V, $V_L = 10$ V, $R_L = 100$ $\Omega$ AQY2C2R2P: $V_{IN} = 3.3$ V, $V_L = 10$ V, $R_L = 100$ $\Omega$ AQY2C1R3P: $V_{IN} = 3.3$ V, $V_L = 10$ V, $R_L = 125$ $\Omega$ AQY2C5R3P: $V_{IN} = 3.3$ V, $V_L = 10$ V, $R_L = 125$ $\Omega$	
			Max.	1 ms				0.2 ms		0.5 ms
			Typ.	0.12 ms	0.06 ms	0.08 ms	0.01 ms	0.03 ms		
			Max.	0.5 ms				0.1 ms		0.2 ms
	Turn off time*	$T_{off}$	Typ.	0.06 ms	0.04 ms	0.06 ms	0.01 ms	0.02 ms	AQY2C1R6P: $V_{IN} = 3.3$ V, $V_L = 10$ V, $R_L = 100$ $\Omega$ AQY2C1R2P: $V_{IN} = 3.3$ V, $V_L = 10$ V, $R_L = 100$ $\Omega$ AQY2C2R2P: $V_{IN} = 3.3$ V, $V_L = 10$ V, $R_L = 100$ $\Omega$ AQY2C1R3P: $V_{IN} = 3.3$ V, $V_L = 10$ V, $R_L = 125$ $\Omega$ AQY2C5R3P: $V_{IN} = 3.3$ V, $V_L = 10$ V, $R_L = 125$ $\Omega$	
			Max.	0.2 ms				0.1 ms		0.2 ms
			Typ.	0.1 ms	0.06 ms	0.1 ms	0.02 ms	0.04 ms		
			Max.	0.5 ms				0.2 ms		0.5 ms
I/O capacitance	Typ.	$C_{iso}$	1.2 pF				$f = 1$ MHz, $V_B = 0$ V			
	Max.		3 pF							

\*Turn on/Turn off time

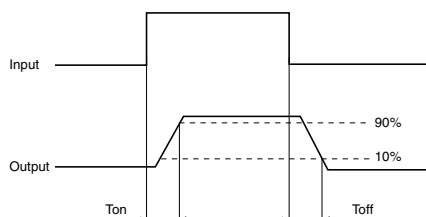

**3. Recommended operating conditions** (Ambient temperature: 25°C 77°F)

Please use under recommended operating conditions to obtain expected characteristics.

Item	Symbol	Min.	Max.	Unit	
Input voltage	$V_{IN}$	3	5	V	
AQY2C1R6P	Load voltage (Peak AC)	$V_L$	—	15	V
	Continuous load current	$I_L$	—	0.75	A
AQY2C1R2P	Load voltage (Peak AC)	$V_L$	—	15	V
	Continuous load current	$I_L$	—	0.3	A
AQY2C2R2P	Load voltage (Peak AC)	$V_L$	—	30	V
	Continuous load current	$I_L$	—	0.3	A
AQY2C1R3P	Load voltage (Peak AC)	$V_L$	—	15	V
	Continuous load current	$I_L$	—	0.1	A
AQY2C5R3P	Load voltage (Peak AC)	$V_L$	—	50	V
	Continuous load current	$I_L$	—	0.12	A

■ These products are not designed for automotive use.

If you are considering to use these products for automotive applications, please contact your local Panasonic Corporation technical representative.

**REFERENCE DATA**

1. Load current vs. ambient temperature characteristics

Allowable ambient temperature: -40 to +105°C  
-40 to +221°F

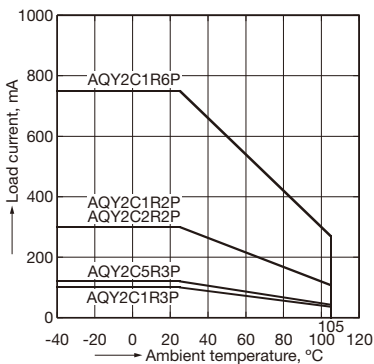

2-(1). On resistance vs. ambient temperature characteristics

Measured portion: between terminals 3 and 4,  
Input voltage: 5V  
Load voltage: 10V (DC)  
Continuous load current:  
750mA (DC) AQY2C1R6P  
300mA (DC) AQY2C1R2P, AQY2C2R2P

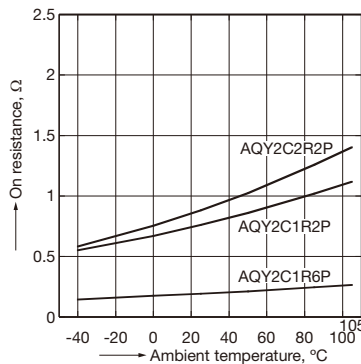

2-(2). On resistance vs. ambient temperature characteristics

Measured portion: between terminals 3 and 4,  
Input voltage: 5V  
Load voltage: 10V (DC)  
Continuous load current:  
80mA (DC) AQY2C1R3P, AQY2C5R3P

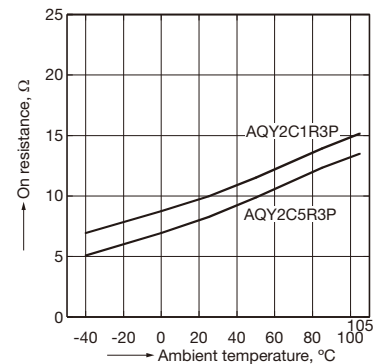

3-(1). Turn on time vs. ambient temperature characteristics

Measured portion: between terminals 3 and 4,  
Input voltage: 5V  
Load voltage: 10V (DC)  
Continuous load current: 100mA

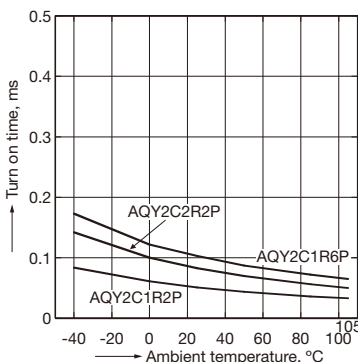

3-(2). Turn on time vs. ambient temperature characteristics

Measured portion: between terminals 3 and 4,  
Input voltage: 5V  
Load voltage: 10V (DC)  
Continuous load current: 80mA

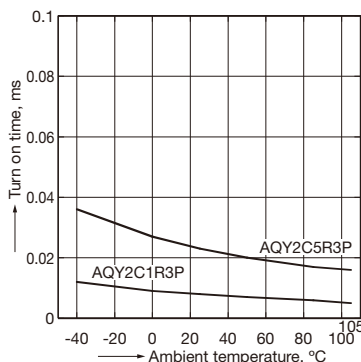

4-(1). Turn off time vs. ambient temperature characteristics

Measured portion: between terminals 3 and 4,  
Input voltage: 5V  
Load voltage: 10V (DC)  
Continuous load current: 100mA

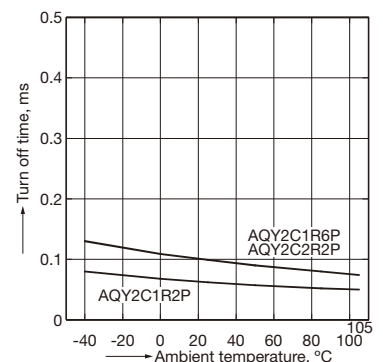

## 4-(2). Turn off time vs. ambient temperature characteristics

Measured portion: between terminals 3 and 4,  
 Input voltage: 5V  
 Load voltage: 10V (DC)  
 Continuous load current: 80mA

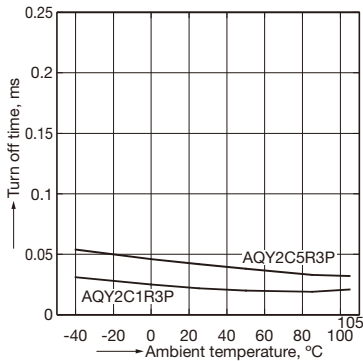

## 5. Operate voltage vs. ambient temperature characteristics

Measured portion: between terminals 3 and 4  
 Load voltage: 10V (DC)  
 Continuous load current:  
 100mA (DC) AQY2C1R6P  
 300mA (DC) AQY2C1R2P, AQY2C2R2P  
 80mA (DC) AQY2C1R3P, AQY2C5R3P

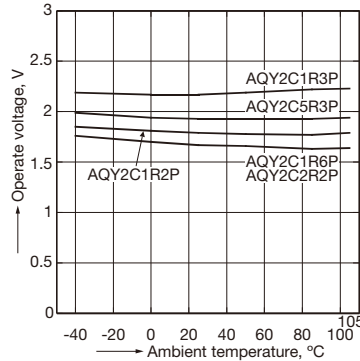

## 6. Turn off voltage vs. ambient temperature characteristics

Measured portion: between terminals 3 and 4  
 Load voltage: 10V (DC)  
 Continuous load current:  
 100mA (DC) AQY2C1R6P  
 300mA (DC) AQY2C1R2P, AQY2C2R2P  
 80mA (DC) AQY2C1R3P, AQY2C5R3P

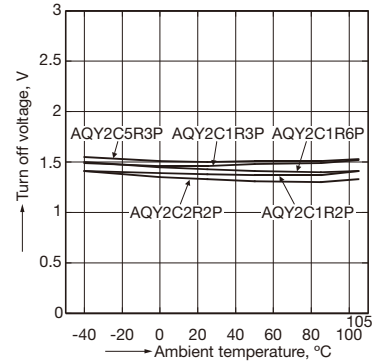

## 7. Input current vs. ambient temperature characteristics

Sample: All types  
 Input voltage: 3.3V, 5V

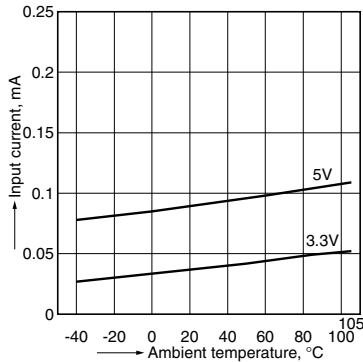

## 8-(1). Current vs. voltage characteristics of output at MOS portion

Measured portion: between terminals 3 and 4  
 Input voltage: 5V  
 Ambient temperature: 25°C 77°F

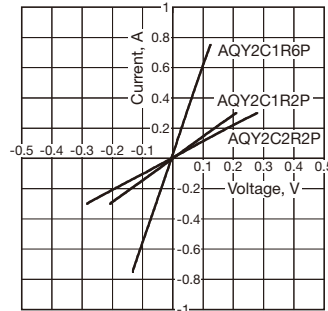

## 8-(2). Current vs. voltage characteristics of output at MOS portion

Measured portion: between terminals 3 and 4  
 Input voltage: 5V  
 Ambient temperature: 25°C 77°F

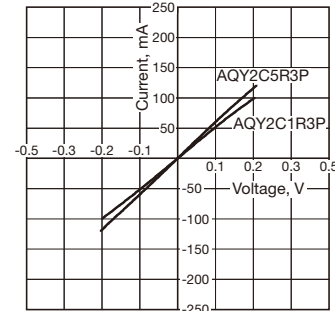

## 9. Input current vs. input voltage characteristics

Sample: All types  
 Ambient temperature: 25°C 77°F  
 (Recommended input voltage: 3 to 5 V)

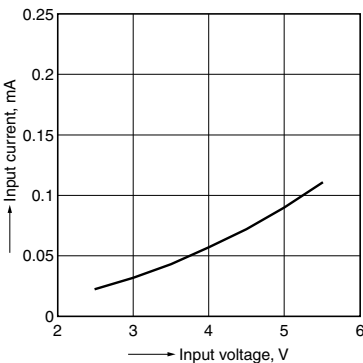

## 10-(1). Off state leakage current vs. load voltage characteristics

Measured portion: between terminals 3 and 4  
 Ambient temperature: 25°C 77°F

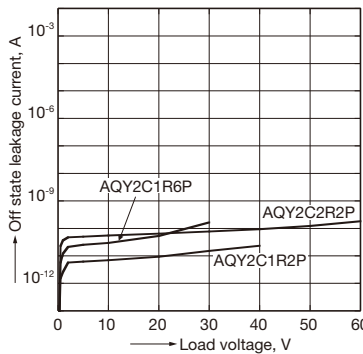

## 10-(2). Off state leakage current vs. load voltage characteristics

Measured portion: between terminals 3 and 4  
 Ambient temperature: 25°C 77°F

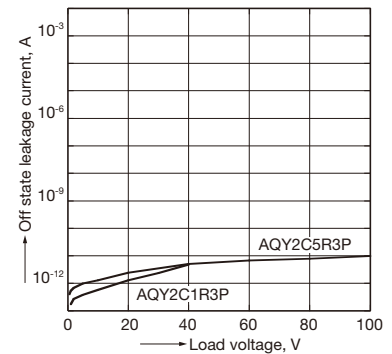

11-(1). Turn on time vs. input voltage characteristics

Measured portion: between terminals 3 and 4,  
Load voltage: 10V (DC)  
Continuous load current: 100mA (DC)  
Ambient temperature: 25°C 77°F

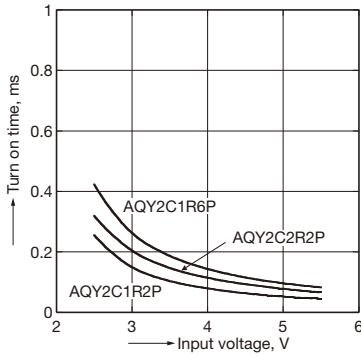

11-(2). Turn on time vs. input voltage characteristics

Measured portion: between terminals 3 and 4,  
Load voltage: 10V (DC)  
Continuous load current: 80mA (DC)  
Ambient temperature: 25°C 77°F

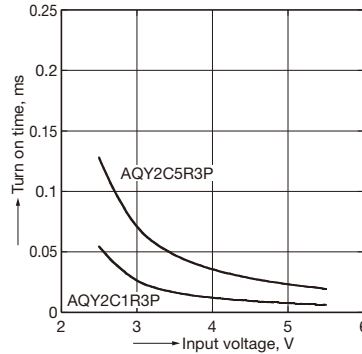

12-(1). Turn off time vs. input voltage characteristics

Measured portion: between terminals 3 and 4,  
Load voltage: 10V (DC)  
Continuous load current: 100mA (DC)  
Ambient temperature: 25°C 77°F

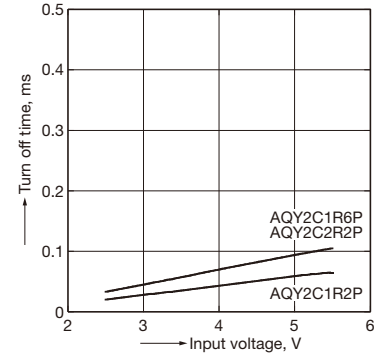

12-(2). Turn off time vs. input voltage characteristics

Measured portion: between terminals 3 and 4,  
Load voltage: 10V (DC)  
Continuous load current: 80mA (DC)  
Ambient temperature: 25°C 77°F

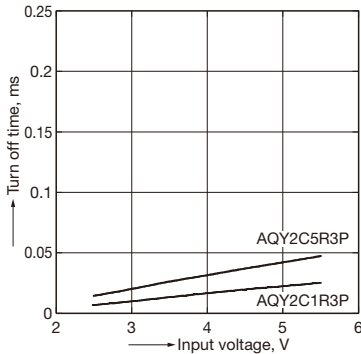

13-(1). Output capacitance vs. applied voltage characteristics

Measured portion: between terminals 3 and 4  
Frequency: 1MHz (30mVrms),  
Ambient temperature: 25°C 77°F

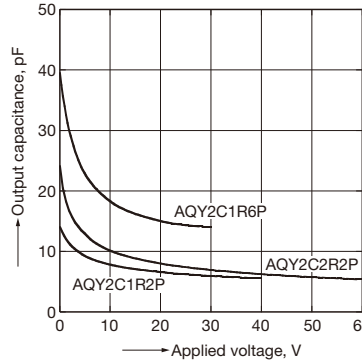

13-(2). Output capacitance vs. applied voltage characteristics

Measured portion: between terminals 3 and 4  
Frequency: 1MHz (30mVrms),  
Ambient temperature: 25°C 77°F

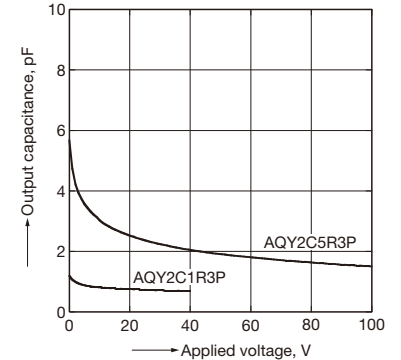

14. Isolation vs. frequency characteristic (50Ω impedance)

Measured portion: between terminals 3 and 4  
Ambient temperature: 25°C 77°F

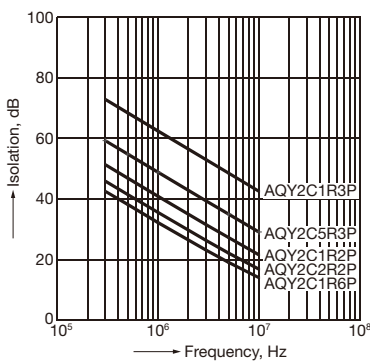

15. Insertion loss vs. frequency characteristic (50Ω impedance)

Measured portion: between terminals 3 and 4,  
Input voltage: 5V  
Ambient temperature: 25°C 77°F

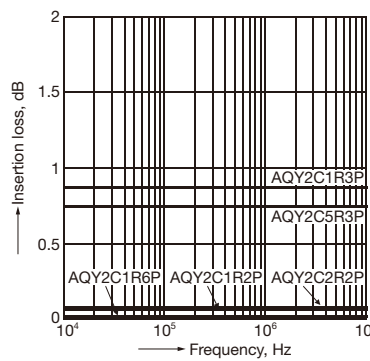

16-(1) On resistance distribution

Sample: AQY2C1R6P,  
Measured portion: between terminals 3 and 4  
Input voltage: 5V,  
Continuous load current: 750mA (DC)  
n: 50 pcs., Ambient temperature: 25°C 77°F

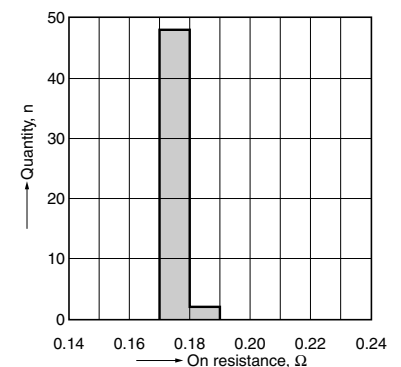

## 16.-(2) On resistance distribution

Sample: AQY2C1R2P,  
 Measured portion: between terminals 3 and 4  
 Input voltage: 5V,  
 Continuous load current: 300mA (DC)  
 n: 50 pcs., Ambient temperature: 25°C 77°F

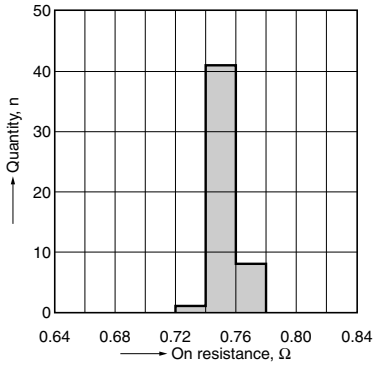

## 16.-(3) On resistance distribution

Sample: AQY2C2R2P,  
 Measured portion: between terminals 3 and 4  
 Input voltage: 5V,  
 Continuous load current: 300mA (DC)  
 n: 50 pcs., Ambient temperature: 25°C 77°F

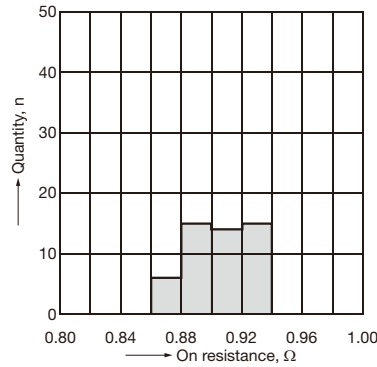

## 16.-(4) On resistance distribution

Sample: AQY2C1R3P,  
 Measured portion: between terminals 3 and 4  
 Input voltage: 5V,  
 Continuous load current: 80mA (DC)  
 n: 50 pcs., Ambient temperature: 25°C 77°F

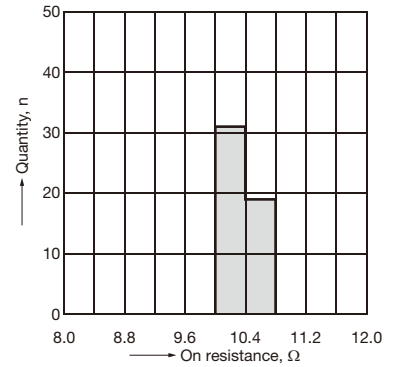

## 16.-(5) On resistance distribution

Sample: AQY2C5R3P,  
 Measured portion: between terminals 3 and 4  
 Input voltage: 5V,  
 Continuous load current: 80mA (DC)  
 n: 50 pcs., Ambient temperature: 25°C 77°F

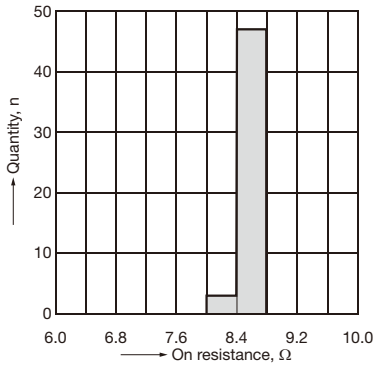

## 17.-(1) Turn on time distribution

Sample: AQY2C1R6P, Input voltage: 5V  
 Load voltage: 10V (DC),  
 Continuous load current: 100mA (DC)  
 n: 50 pcs., Ambient temperature: 25°C 77°F

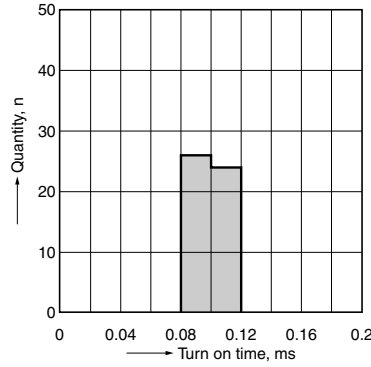

## 17.-(2) Turn on time distribution

Sample: AQY2C1R2P, Input voltage: 5V  
 Load voltage: 10V (DC),  
 Continuous load current: 100mA (DC)  
 n: 50 pcs., Ambient temperature: 25°C 77°F

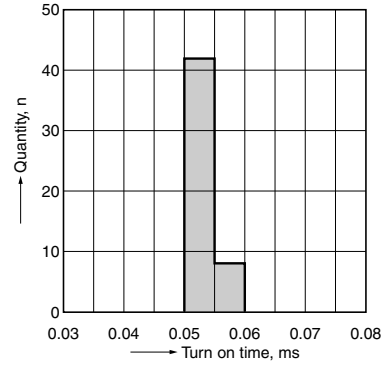

## 17.-(3) Turn on time distribution

Sample: AQY2C2R2P, Input voltage: 5V  
 Load voltage: 10V (DC),  
 Continuous load current: 100mA (DC)  
 n: 50 pcs., Ambient temperature: 25°C 77°F

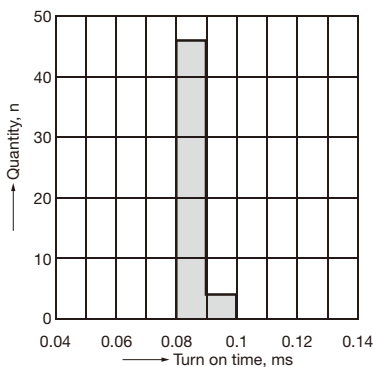

## 17.-(4) Turn on time distribution

Sample: AQY2C1R3P, Input voltage: 5V  
 Load voltage: 10V (DC),  
 Continuous load current: 80mA (DC)  
 n: 50 pcs., Ambient temperature: 25°C 77°F

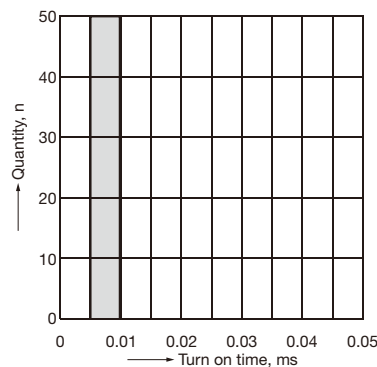

## 17.-(5) Turn on time distribution

Sample: AQY2C5R3P, Input voltage: 5V  
 Load voltage: 10V (DC),  
 Continuous load current: 80mA (DC)  
 n: 50 pcs., Ambient temperature: 25°C 77°F

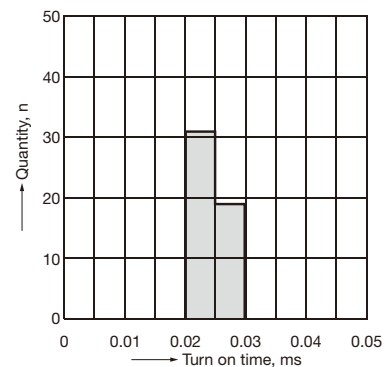

18.-(1) Turn off time distribution

Sample: AQY2C1R6P, Input voltage: 5V  
 Load voltage: 10V (DC),  
 Continuous load current: 100mA (DC)  
 n: 50 pcs., Ambient temperature: 25°C 77°F

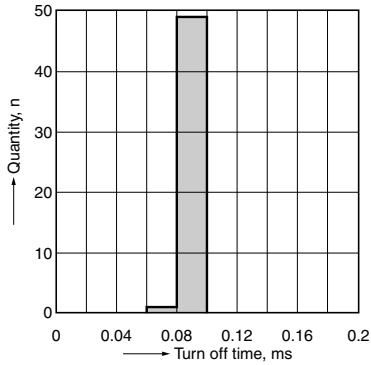

18.-(2) Turn off time distribution

Sample: AQY2C1R2P, Input voltage: 5V  
 Load voltage: 10V (DC),  
 Continuous load current: 100mA (DC)  
 n: 50 pcs., Ambient temperature: 25°C 77°F

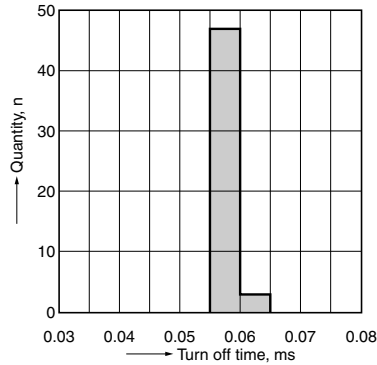

18.-(3) Turn off time distribution

Sample: AQY2C2R2P, Input voltage: 5V  
 Load voltage: 10V (DC),  
 Continuous load current: 100mA (DC)  
 n: 50 pcs., Ambient temperature: 25°C 77°F

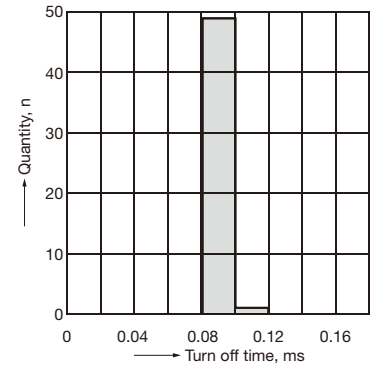

18.-(4) Turn off time distribution

Sample: AQY2C1R3P, Input voltage: 5V  
 Load voltage: 10V (DC),  
 Continuous load current: 80mA (DC)  
 n: 50 pcs., Ambient temperature: 25°C 77°F

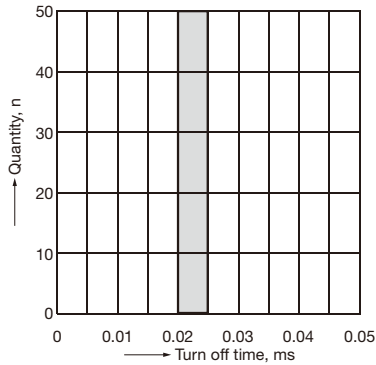

18.-(5) Turn off time distribution

Sample: AQY2C5R3P, Input voltage: 5V  
 Load voltage: 10V (DC),  
 Continuous load current: 80mA (DC)  
 n: 50 pcs., Ambient temperature: 25°C 77°F

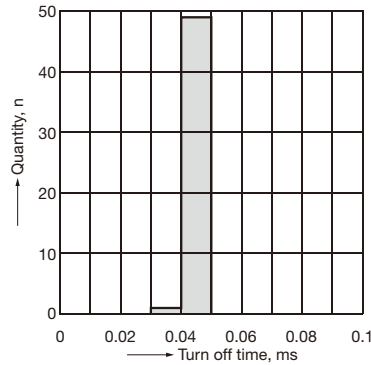

19.-(1) Operate voltage distribution

Sample: AQY2C1R6P, Load voltage: 10V (DC)  
 Continuous load current: 100mA (DC)  
 n: 50 pcs., Ambient temperature: 25°C 77°F

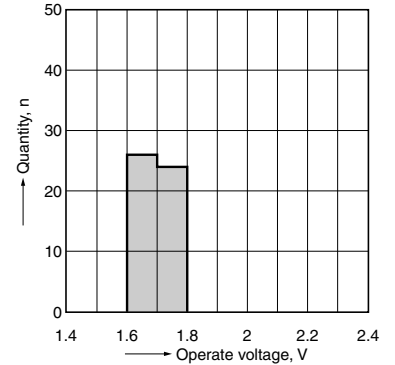

19.-(2) Operate voltage distribution

Sample: AQY2C1R2P, Load voltage: 10V (DC)  
 Continuous load current: 300mA (DC)  
 n: 50 pcs., Ambient temperature: 25°C 77°F

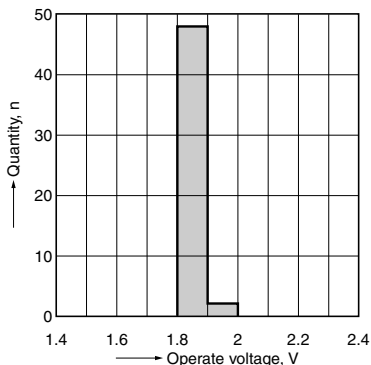

19.-(3) Operate voltage distribution

Sample: AQY2C2R2P, Load voltage: 10V (DC)  
 Continuous load current: 300mA (DC)  
 n: 50 pcs., Ambient temperature: 25°C 77°F

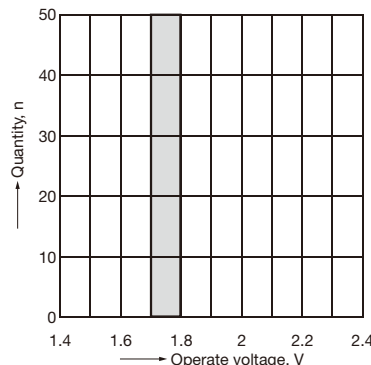

19.-(4) Operate voltage distribution

Sample: AQY2C1R3P, Load voltage: 10V (DC)  
 Continuous load current: 80mA (DC)  
 n: 50 pcs., Ambient temperature: 25°C 77°F

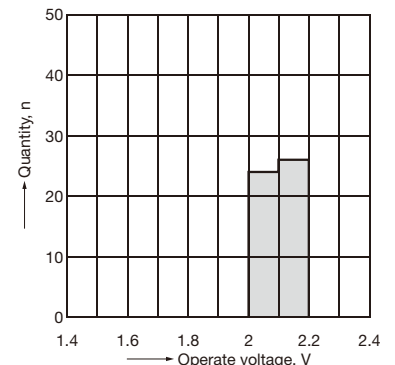

# CC TSON C×R (AQY2C○○○P)

## 19.-(5) Operate voltage distribution

Sample: AQY2C5R3P, Load voltage: 10V (DC)

Continuous load current: 80mA (DC)

n: 50 pcs., Ambient temperature: 25°C 77°F

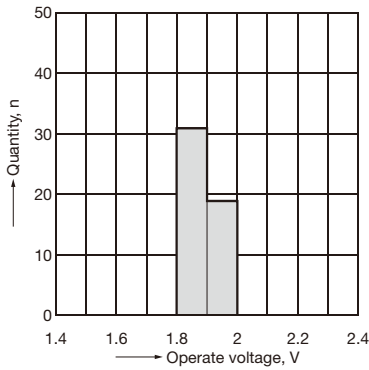

## DIMENSIONS (mm inch)

The CAD data of the products with a **CAD** mark can be downloaded from: <http://industrial.panasonic.com/ac/e/>

**CAD**

### External dimensions

### Recommended mounting pad (Top view)

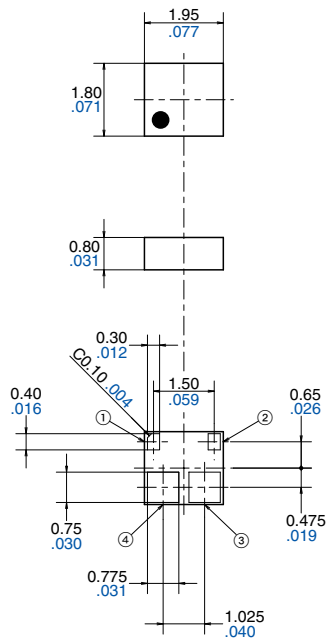

- ① Input: DC+
- ② Input: DC-
- ③ Output: AC/DC
- ④ Output: AC/DC

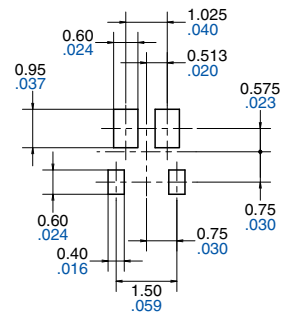

Tolerance:  $\pm 0.1 \pm .004$

General tolerance:  $\pm 0.2 \pm .008$

## SCHEMATIC AND WIRING DIAGRAMS

$V_{IN}$ : Input voltage,  $I_{IN}$ : Input current,  $V_L$ : Load voltage,  $I_L$ : Load current

Schematic	Output configuration	Load type	Connection	Wiring diagram
	1a	AC/DC	—	



## Cautions for Use

For cautions for general use, please read “PhotoMOS® cautions for Use” at Automation Control WEB site (as described in footer of catalog).

### CC TSON C×R Cautions for Use

#### 1. Derating design

Derating is a significant factor for reliable design and product life. Even if the conditions of use (temperature, current, voltage, etc.) of the product are within the absolute maximum ratings, reliability may be lowered remarkably when continuously used in high load conditions (high temperature, high humidity, high current, high voltage, etc.) Therefore, please derate sufficiently below the absolute maximum ratings and evaluate the device in the actual condition.

Moreover, regardless of the application, if malfunctioning can be expected to pose high risk to human life or to property, or if products are used in equipment otherwise requiring high operational safety, in addition to designing double circuits, that is, incorporating features such as a protection circuit or a redundant circuit, safety testing should also be carried out.

#### 2. Applying stress that exceeds the absolute maximum rating

If the voltage or current value for any of the terminals exceeds the absolute maximum rating, internal elements will deteriorate because of the overvoltage or overcurrent. In extreme cases, wiring may melt, or silicon P/N junctions may be destroyed. Therefore, the circuit should be designed in such a way that the load never exceed the absolute maximum ratings, even momentarily.

#### 3. Input voltage

For rising and dropping ratio of input voltage(dv/dt), maintain min. 100mV/ms.

#### 4. Oscillation circuit and control circuit

The oscillation circuit and control circuit of product may be destroyed by external noise, surge, static electricity and so on. For noise effect to peripheral circuits when oscillation circuit operates, please implement safety measures on the system before use by verifying operation under the actual design.

#### 5. Deterioration and destruction caused by discharge of static electricity

This phenomenon is generally called static electricity destruction, and occurs when static electricity generated by various factors is discharged while the PhotoMOS® terminals are in contact, producing internal destruction of the element. To prevent problems from static electricity, the following precautions and measures should be taken when using your device.

- (1) Employees handling PhotoMOS® should wear anti-static clothing and should be grounded through protective resistance of 500kΩ to 1MΩ.
- (2) A conductive metal sheet should be placed over the worktable. Measuring instruments and jigs should be grounded.
- (3) When using soldering irons, either use irons with low leakage current, or ground the tip of the soldering iron.  
(Use of low-voltage soldering irons is also recommended.)
- (4) Devices and equipment used in assembly should also be grounded.
- (5) When packing printed circuit boards and equipment, avoid using high-polymer materials such as foam styrene, plastic, and other materials which carry an electrostatic charge.

(6) When storing or transporting PhotoMOS®, the environment should not be conducive to generating static electricity (for instance, the humidity should be between 45% and 60%), and PhotoMOS® should be protected using conductive packing materials.

#### 6. Short across terminals

Do not short circuit between terminals when device is energized, since there is possibility of breaking of the internal IC.

#### 7. Recommended operating conditions

Design in accordance with the recommended operating conditions for each product.

Since these conditions are affected by the operating environment, ensure conformance with all relevant specifications.

#### 8. Ripple in the input power supply

If ripple is present in the input power supply, observe the following:

- 1) Please maintain the input voltage at least 3V for  $E_{min}$ .
- 2) Please make sure the input voltage for  $E_{max}$  is no higher than 5.5V.
- 3) Please keep amplitude voltage of ripple within  $\pm 0.5V$ .

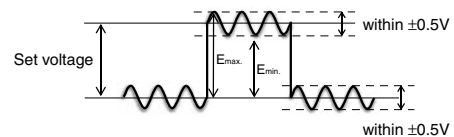

#### 9. Output spike voltages

1) If an inductive load generates spike voltages which exceed the absolute maximum rating, the spike voltage shall be limited. Representative circuit examples of AC/DC dual use type are shown below. It is the same with DC only type.

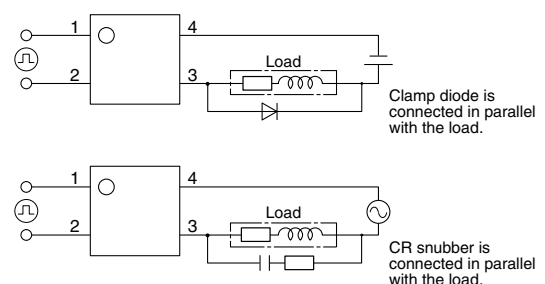

2) When Clamp diode or CR Snubber is used in the circuit, the spike voltages from the load are limited. But the longer wire may become the inductance and cause the spike voltage. Keep the wire as short as possible.

## 10. Reverse voltages at the input

If reverse voltages are present at the input terminals, for example, connect a schottky barrier diode in reverse parallel across the input terminals and keep the reverse voltages below the reverse breakdown voltage. Typical circuit is shown below.

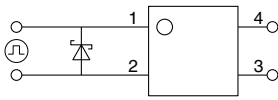

## 11. Connection between input and output

If you wish to use the product with a connection between input and output, you may not obtain performance. Therefore, please be sure to evaluate the device in the actual usage before use. A circuit example is shown below that may negatively affect PhotoMOS® characteristics.

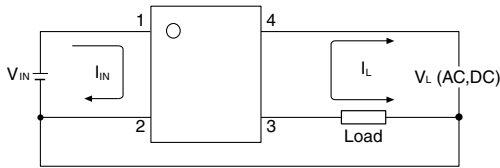

## 12. Cleaning solvents compatibility

Cleaning the solder flux should use the immersion washing with an organic solvent. If you have to use ultrasonic cleaning, please adopt the following conditions and check that there are no problems in the actual usage.

- Frequency: 27 to 29kHz
- Ultrasonic output: No greater than 0.25W/cm<sup>2\*</sup>
- Cleaning time: 30s or less
- Cleanser used: Asahiklin AK-225
- Others:  
Float PCB and the device in the cleaning solvent to prevent from contacting the ultrasonic vibrator.

\*Note: Applies to unit area ultrasonic output for ultrasonic baths

## 13. Notes for mounting

- 1) When different kinds of packages are mounted on PCB, temperature rise at soldering lead is highly dependent on package size. Therefore, please set the lower temperature soldering condition than the conditions of item "14. Soldering", and confirm the temperature condition of actual usage before soldering.
- 2) When soldering condition exceeds our recommendation, the PhotoMOS® characteristics may be adversely affected. It may occur package crack or bonding wire breaking because of thermal expansion unconformity and resin strength reduction. Please contact us about the propriety of the condition.
- 3) Please confirm the heat stress by using actual board because it may be changed by board condition or manufacturing process condition
- 4) Solder creepage, wettability, or soldering strength will be affected by the soldering condition or used soldering type. Please check them under the actual production condition in detail.
- 5) Please apply coating when the device returns to a room temperature.

## 14. Soldering

(1) IR (Infrared reflow) soldering method

In case of automatic soldering, following conditions should be observed.

(recommended condition reflow: Max. 2 times, measurement point: soldering lead)

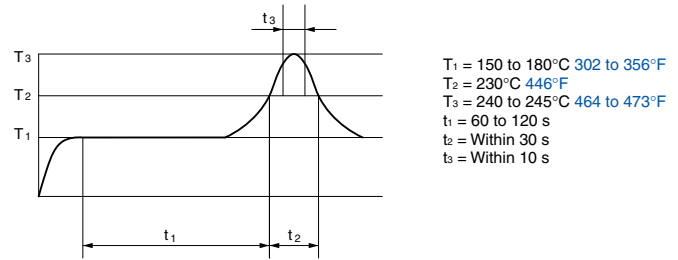

(2) Other soldering methods

Other soldering methods (VPS, hot-air, hot plate, laser heating, pulse heater, etc.) affect the PhotoMOS® characteristics differently, please evaluate the device under the actual usage.

(3) Manual soldering method

Temperature: 350 to 400°C 662 to 752°F, electrical power 30 to 60W, within 3s

- We recommend one with an alloy composition of Sn3.0Ag0.5Cu.

## 15. Transportation and storage

1) Extreme vibration during transport may deform the lead or damage the PhotoMOS® characteristics. Please handle the outer and inner boxes with care.

2) Inadequate storage condition may degrade soldering, appearance, and characteristics. The following storage conditions are recommended:

- Temperature: 0 to 45°C 32 to 113°F
- Humidity: Max. 70%RH
- Atmosphere: No harmful gasses such as sulfurous acid gas, minimal dust.

3) Storage before TSON processing

In case the heat stress of soldering is applied to the PhotoMOS® which absorbs moisture inside of its package, the evaporation of the moisture increases the pressure inside the package and it may cause the package blister or crack. This device is sensitive to moisture and it is packed in the sealed moisture-proof package. Please make sure the following condition after unsealing.

- Please use the device immediately after unsealing. (Within 30 days at 0 to 30°C 32 to 86°F and Max. 70%RH)
- If the device will be kept for a long time after unsealing, please store in the another moisture-proof package containing silica gel. (Please use within 90 days.)

## 16. Water condensation

Water condensation occurs when the ambient temperature changes suddenly from a high temperature to low temperature at high humidity, or the device is suddenly transferred from a low ambient temperature to a high temperature and humidity. Condensation causes the failures such as insulation deterioration. Panasonic Corporation does not guarantee the failures caused by water condensation. The heat conduction by the equipment the PhotoMOS® is mounted may accelerate the water condensation. Please confirm that there is no condensation in the worst condition of the actual usage. (Special attention should be paid when high temperature heating parts are close to the PhotoMOS®.)

**Packaging format**

1) Tape and reel (Unit: mm inch)

Tape dimensions	Dimensions of tape reel
<p>(1) When picked from 1/2-pin side: Part No. AQY2C○ROPX (Shown above)                  (2) When picked from 3/4-pin side: Part No. AQY2C○ROPZ</p>	

"PhotoMOS®", "PhotoMOS" and "PHOTOMOS" are registered trademarks of Panasonic Corporation.

\*Recognized in Japan, the United States, all member states of European Union and other countries.

Please contact .....

**Panasonic Corporation**

Electromechanical Control Business Division

■ 1006, Oaza Kadoma, Kadoma-shi, Osaka 571-8506, Japan  
[industrial.panasonic.com/ac/e/](http://industrial.panasonic.com/ac/e/)

**Panasonic®**

©Panasonic Corporation 2018

## X-ON Electronics

Largest Supplier of Electrical and Electronic Components

*Click to view similar products for [Solid State Relays - PCB Mount](#) category:*

*Click to view products by [Panasonic](#) manufacturer:*

Other Similar products are found below :

[M86F-2W](#) [M90F-2Y](#) [G2-1A07-ST](#) [G2-1A07-TT](#) [G2-1B02-TT](#) [G2-DA06-ST](#) [923812OCAS](#) [PLA134S](#) [DS11-1005](#) [AQV212J](#)  
[AQY412EHAJ](#) [EFR1200480A150](#) [901-7](#) [LCA220](#) [LCB110S](#) [1618400-5](#) [SR75-1ST](#) [AQH2213AJ](#) [AQV112KLJ](#) [AQV212AJ](#) [AQV212SXJ](#)  
[AQV238AD01](#) [AQW414TS](#) [AQY221N2SYD01](#) [AQY221R2VJ](#) [AQY275AXJ](#) [AQY414SXE01](#) [G2-1A02-ST](#) [G2-1A03-ST](#) [G2-1A03-TT](#)  
[G2-1A05-ST](#) [G2-1A06-TT](#) [G2-1A23-TT](#) [G2-1B01-ST](#) [G2-1B01-TT](#) [G2-1B02-ST](#) [G2-DA03-ST](#) [G2-DA03-TT](#) [G2-DA06-TT](#) [CPC1333GR](#)  
[3-1617776-2](#) [CTA2425](#) [TLP3131\(F\)](#) [LBA110S](#) [LBB110S](#) [LCA110LSTR](#) [LCB126S](#) [WPPM-0626D](#) [WPPM-3526D](#) [WPPM-3588D](#)