

NEW SUBMINIATURE SWITCHES WITH HIGH PRECISION

AV (FS•FS-T) SWITCHES



FS



FS-T

RoHS compliant

FEATURES

- Consistent quality and high precision through sophisticated automatic fabrication system —O.P.: 8.4 ± 0.3 mm (O.P. of conventional subminiature switches: 8.4 ± 0.5)
- Flux-resistant construction with integrally molded terminals
- Solder terminal; Self-standing, internationally common pitch, right angle, left angle terminals for PC board; Quick connect .110 terminals for easy mounting
- Insulation guard available for safety mounting

- 2 lever pivot positions available for applications where low operating force is required

TYPICAL APPLICATIONS

- Communication equipment
- Vending machines
- Security systems
- Data systems
- Medical equipment
- VCR



CONSTRUCTION (Example: AV3/AVM3 type)

Standard version



Long life version



CONTACT ARRANGEMENT



Remark: As for FS-T switches, the terminals are the different shape.

ORDERING INFORMATION

1.FS switches

Ex. AV 3 2 0 2 [] [] 3

| Type of switch | Version | Terminals | Actuators | Operating force by pin plunger, max. | Lever position | Contacts | International standard |
|----------------|-------------|--|---|--|-----------------------------|--|------------------------|
| AV3(FS) switch | 3: Standard | 1: Solder terminal with guard 2: Solder terminal without guard 3: Solder terminal with opposite side guard 4: Self-standing PC terminal 5: Internationally common pitch PC terminal 6: Right angle terminal 7: Left angle terminal 8: .110 Quick-connect terminal | 0: Pin plunger 1: Short hinge lever 2: Hinge lever 3: Long hinge lever 4: Simulated roller lever 5: Roller lever | 0: 0.25 N (Gold-clad contact only) 2: 0.49 N 4: 0.98 N | Nil: Standard [11: forward] | Nil: AgNi alloy 61: Gold-clad triple layer* | 3: UL/CSA/VDE/SEMKO |

Ex. AV M3 2 0 2 [] [] 3

| Type of switch | Version | Terminals | Actuators | Operating force by pin plunger, max. | Lever position | Contacts | International standard |
|--------------------------------|---------------|--|---|--------------------------------------|-----------------------------|--|------------------------|
| AV3 (FS long life ver.) switch | M3: Long life | 1: Solder terminal with guard 2: Solder terminal without guard 3: Solder terminal with opposite side guard 4: Self-standing PC terminal 5: Internationally common pitch PC terminal 6: Right angle terminal 7: Left angle terminal 8: .110 Quick-connect terminal | 0: Pin plunger 1: Short hinge lever 2: Hinge lever 3: Long hinge lever 4: Simulated roller lever 5: Roller lever | 5: 1.47 N | Nil: Standard [11: forward] | Nil: AgNi alloy 61: Gold-clad triple layer* | 3: UL/CSA/VDE/SEMKO |

2.FS-T switches

Ex. AV T3 2 0 2 [] [] 3

| Type of switch | Version | Terminals | Actuators | Operating force by pin plunger, max. | Lever position | Contacts | Agency standard |
|--------------------|--------------|--|---|--|-----------------------------|--|---------------------|
| AVT3 (FS-T) switch | T3: Standard | 2: Solder terminal 4: PC terminal 8: .110 Quick-connect terminal | 0: Pin plunger 1: Short hinge lever 2: Hinge lever 3: Long hinge lever 4: Simulated roller lever 5: Roller lever | 0: 0.25 N (Gold-clad contact only) 2: 0.49 N 4: 0.98 N | Nil: Standard [11: forward] | Nil: AgNi alloy (Not applicable to 0.25 N type) 61: Gold-clad triple layer* | 3: UL/CSA/VDE/SEMKO |

Ex. AV L3 2 0 2 [] [] 3

| Type of switch | Version | Terminals | Actuators | Operating force by pin plunger, max. | Lever position | Contacts | Agency standard |
|-----------------------------------|---------------|--|---|--------------------------------------|-----------------------------|--|---------------------|
| AVL3 (FS-T long life ver.) switch | L3: Long life | 2: Solder terminal 4: PC terminal 8: .110 Quick-connect terminal | 0: Pin plunger 1: Short hinge lever 2: Hinge lever 3: Long hinge lever 4: Simulated roller lever 5: Roller lever | 5: 1.47 N | Nil: Standard [11: forward] | Nil: AgNi alloy (Not applicable to 0.25 N type) 61: Gold-clad triple layer* | 3: UL/CSA/VDE/SEMKO |

* Gold-clad triple layer contact

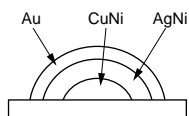

AV3,AVM3/AVT3,AVL3

APPLICABLE CURRENT RANGE

| Type | Contact | Rating | | | | O.F. | | | |
|-------------------|-------------------------------------|--------|-------|----|----|--------|--------|--------|--------|
| | | 1mA | 100mA | 3A | 5A | 0.25 N | 0.49 N | 0.98 N | 1.47 N |
| Standard version | Silver alloy contact | | | | | | ● | ● | |
| | Gold-clad triple layer contact type | | | | | ● | ● | ● | |
| Long life version | Silver alloy contact | | | | | | | | ● |
| | Gold-clad triple layer contact type | | | | | | | | ● |

Remark: For high capacity contact rating up to 10.1 A, please refer to PS (AVM3□□□P) switches catalog.

PRODUCT TYPES

1. FS switches (In-line terminal type)

Standard type

| | Actuator | Operating force, Max. | Part No. | | | | |
|-------------------------------------|------------------------|-----------------------|-------------------------------|------------|--------------------------|---------------------------|--|
| | | | Self-standing solder terminal | | | Self-standing PC terminal | Internationally common pitch PC terminal |
| | | | Without guard | With guard | With opposite side guard | | |
| AgNi alloy contact type | Pin plunger | 0.49N | AV32023 | AV31023 | AV33023 | AV34023 | AV35023 |
| | | 0.98N | AV32043 | AV31043 | AV33043 | AV34043 | AV35043 |
| | Short hinge lever | 0.20N | AV32123 | AV31123 | AV33123 | AV34123 | AV35123 |
| | | 0.39N | AV32143 | AV31143 | AV33143 | AV34143 | AV35143 |
| | Hinge lever | 0.16N | AV32223 | AV31223 | AV33223 | AV34223 | AV35223 |
| | | 0.34N | AV32243 | AV31243 | AV33243 | AV34243 | AV35243 |
| | Long hinge lever | 0.12N | AV32323 | AV31323 | AV33323 | AV34323 | AV35323 |
| | | 0.25N | AV32343 | AV31343 | AV33343 | AV34343 | AV35343 |
| | Simulated roller lever | 0.16N | AV32423 | AV31423 | AV33423 | AV34423 | AV35423 |
| | | 0.34N | AV32443 | AV31443 | AV33443 | AV34443 | AV35443 |
| | Roller lever | 0.20N | AV32523 | AV31523 | AV33523 | AV34523 | AV35523 |
| | | 0.39N | AV32543 | AV31543 | AV33543 | AV34543 | AV35543 |
| Gold-clad triple layer contact type | Pin plunger | 0.25N | AV3200613 | AV3100613 | AV3300613 | AV3400613 | AV3500613 |
| | | 0.49N | AV3202613 | AV3102613 | AV3302613 | AV3402613 | AV3502613 |
| | | 0.98N | AV3204613 | AV3104613 | AV3304613 | AV3404613 | AV3504613 |
| | Short hinge lever | 0.098N | AV3210613 | AV3110613 | AV3310613 | AV3410613 | AV3510613 |
| | | 0.20N | AV3212613 | AV3112613 | AV3312613 | AV3412613 | AV3512613 |
| | | 0.39N | AV3214613 | AV3114613 | AV3314613 | AV3414613 | AV3514613 |
| | Hinge lever | 0.078N | AV3220613 | AV3120613 | AV3320613 | AV3420613 | AV3520613 |
| | | 0.16N | AV3222613 | AV3122613 | AV3322613 | AV3422613 | AV3522613 |
| | | 0.34N | AV3224613 | AV3124613 | AV3324613 | AV3424613 | AV3524613 |
| | Long hinge lever | 0.12N | AV3232613 | AV3132613 | AV3332613 | AV3432613 | AV3532613 |
| | | 0.25N | AV3234613 | AV3134613 | AV3334613 | AV3434613 | AV3534613 |
| | Simulated roller lever | 0.16N | AV3242613 | AV3142613 | AV3342613 | AV3442613 | AV3542613 |
| | | 0.34N | AV3244613 | AV3144613 | AV3344613 | AV3444613 | AV3544613 |
| | Roller lever | 0.20N | AV3252613 | AV3152613 | AV3352613 | AV3452613 | AV3552613 |
| | | 0.39N | AV3254613 | AV3154613 | AV3354613 | AV3454613 | AV3554613 |

| | Actuator | Operating force, Max. | Part No. | | | |
|-------------------------|-------------------------------------|--------------------------|----------------------|---------------------|--------------------|-----------|
| | | | Right angle terminal | Left angle terminal | .110 Quick-connect | |
| AgNi alloy contact type | Pin plunger | 0.49N | AV36023 | AV37023 | AV38023 | |
| | | 0.98N | AV36043 | AV37043 | AV38043 | |
| | Short hinge lever | 0.20N | AV36123 | AV37123 | AV38123 | |
| | | 0.39N | AV36143 | AV37143 | AV38143 | |
| | Hinge lever | 0.16N | AV36223 | AV37223 | AV38223 | |
| | | 0.34N | AV36243 | AV37243 | AV38243 | |
| | Long hinge lever | 0.12N | AV36323 | AV37323 | AV38323 | |
| | | 0.25N | AV36343 | AV37343 | AV38343 | |
| | Simulated roller lever | 0.16N | AV36423 | AV37423 | AV38423 | |
| | | 0.34N | AV36443 | AV37443 | AV38443 | |
| | Roller lever | 0.20N | AV36523 | AV37523 | AV38523 | |
| | | 0.39N | AV36543 | AV37543 | AV38543 | |
| | Gold-clad triple layer contact type | Pin plunger | 0.25N | AV3600613 | AV3700613 | AV3800613 |
| | | | 0.49N | AV3602613 | AV3702613 | AV3802613 |
| 0.98N | | | AV3604613 | AV3704613 | AV3804613 | |
| Short hinge lever | | 0.098N | AV3610613 | AV3710613 | AV3810613 | |
| | | 0.20N | AV3612613 | AV3712613 | AV3812613 | |
| | | 0.39N | AV3614613 | AV3714613 | AV3814613 | |
| Hinge lever | | 0.078N | AV3620613 | AV3720613 | AV3820613 | |
| | | 0.16N | AV3622613 | AV3722613 | AV3822613 | |
| | | 0.34N | AV3624613 | AV3724613 | AV3824613 | |
| Long hinge lever | | 0.12N | AV3632613 | AV3732613 | AV3832613 | |
| | | 0.25N | AV3634613 | AV3734613 | AV3834613 | |
| Simulated roller lever | | 0.16N | AV3642613 | AV3742613 | AV3842613 | |
| | | 0.34N | AV3644613 | AV3744613 | AV3844613 | |
| Roller lever | | 0.20N | AV3652613 | AV3752613 | AV3852613 | |
| | 0.39N | AV3654613 | AV3754613 | AV3854613 | | |

Remark: When ordering, please refer to "Remarks" of ordering information.

AV3,AVM3/AVT3,AVL3

2. FS-T switches (Cross-line terminal type)

Standard type

| | Actuator | Operating force, Max. | Part No. | | | |
|----------------------------|--|--------------------------|----------------------------------|-------------|--------------------------------|------------|
| | | | Solder terminal without guard | PC terminal | .110 Quick-connect terminal | |
| AgNi alloy contact type | Pin plunger | 0.49N | AVT32023 | AVT34023 | AVT38023 | |
| | | 0.98N | AVT32043 | AVT34043 | AVT38043 | |
| | Short hinge lever | 0.20N | AVT32123 | AVT34123 | AVT38123 | |
| | | 0.39N | AVT32143 | AVT34143 | AVT38143 | |
| | Hinge lever | 0.16N | AVT32223 | AVT34223 | AVT38223 | |
| | | 0.34N | AVT32243 | AVT34243 | AVT38243 | |
| | Long hinge lever | 0.12N | AVT32323 | AVT34323 | AVT38323 | |
| | | 0.25N | AVT32343 | AVT34343 | AVT38343 | |
| | Simulated roller lever | 0.16N | AVT32423 | AVT34423 | AVT38423 | |
| | | 0.34N | AVT32443 | AVT34443 | AVT38443 | |
| | Roller lever | 0.20N | AVT32523 | AVT34523 | AVT38523 | |
| | | 0.39N | AVT32543 | AVT34543 | AVT38543 | |
| | Gold-clad triple layer contact type | Pin plunger | 0.25N | AVT3200613 | AVT3400613 | AVT3800613 |
| | | | 0.49N | AVT3202613 | AVT3402613 | AVT3802613 |
| 0.98N | | | AVT3204613 | AVT3404613 | AVT3804613 | |
| Short hinge lever | | 0.098N | AVT3210613 | AVT3410613 | AVT3810613 | |
| | | 0.20N | AVT3212613 | AVT3412613 | AVT3812613 | |
| | | 0.39N | AVT3214613 | AVT3414613 | AVT3814613 | |
| Hinge lever | | 0.078N | AVT3220613 | AVT3420613 | AVT3820613 | |
| | | 0.16N | AVT3222613 | AVT3422613 | AVT3822613 | |
| | | 0.34N | AVT3224613 | AVT3424613 | AVT3824613 | |
| Long hinge lever | | 0.12N | AVT3232613 | AVT3432613 | AVT3832613 | |
| | | 0.25N | AVT3234613 | AVT3434613 | AVT3834613 | |
| Simulated roller lever | | 0.16N | AVT3242613 | AVT3442613 | AVT3842613 | |
| | | 0.34N | AVT3244613 | AVT3444613 | AVT3844613 | |
| Roller lever | | 0.20N | AVT3252613 | AVT3452613 | AVT3852613 | |
| | | 0.39N | AVT3254613 | AVT3454613 | AVT3854613 | |

3. FS switches (In-line terminal type)

Long life version

| | Actuator | Operating force, Max. | Part No. | | | | |
|-------------------------------------|------------------------|-----------------------|-------------------------------|------------|--------------------------|---------------------------|--|
| | | | Self-standing solder terminal | | | Self-standing PC terminal | Internationally common pitch PC terminal |
| | | | Without guard | With guard | With opposite side guard | | |
| AgNi alloy contact type | Pin plunger | 1.47N | AVM32053 | AVM31053 | AVM33053 | AVM34053 | AVM35053 |
| | Short hinge lever | 0.59N | AVM32153 | AVM31153 | AVM33153 | AVM34153 | AVM35153 |
| | Hinge lever | 0.54N | AVM32253 | AVM31253 | AVM33253 | AVM34253 | AVM35253 |
| | Long hinge lever | 0.44N | AVM32353 | AVM31353 | AVM33353 | AVM34353 | AVM35353 |
| | Simulated roller lever | 0.54N | AVM32453 | AVM31453 | AVM33453 | AVM34453 | AVM35453 |
| | Roller lever | 0.59N | AVM32553 | AVM31553 | AVM33553 | AVM34553 | AVM35553 |
| Gold-clad triple layer contact type | Pin plunger | 1.47N | AVM3205613 | AVM3105613 | AVM3305613 | AVM3405613 | AVM3505613 |
| | Short hinge lever | 0.59N | AVM3215613 | AVM3115613 | AVM3315613 | AVM3415613 | AVM3515613 |
| | Hinge lever | 0.54N | AVM3225613 | AVM3125613 | AVM3325613 | AVM3425613 | AVM3525613 |
| | Long hinge lever | 0.44N | AVM3235613 | AVM3135613 | AVM3335613 | AVM3435613 | AVM3535613 |
| | Simulated roller lever | 0.54N | AVM3245613 | AVM3145613 | AVM3345613 | AVM3445613 | AVM3545613 |
| | Roller lever | 0.59N | AVM3255613 | AVM3155613 | AVM3355613 | AVM3455613 | AVM3555613 |

| | Actuator | Operating force, Max. | Part No. | | |
|-------------------------------------|------------------------|-----------------------|----------------------|---------------------|--------------------------|
| | | | Right angle terminal | Left angle terminal | .110 Quick-connect |
| | | | Without guard | With guard | With opposite side guard |
| AgNi alloy contact type | Pin plunger | 1.47N | AVM36053 | AVM37053 | AVM38053 |
| | Short hinge lever | 0.59N | AVM36153 | AVM37153 | AVM38153 |
| | Hinge lever | 0.54N | AVM36253 | AVM37253 | AVM38253 |
| | Long hinge lever | 0.44N | AVM36353 | AVM37353 | AVM38353 |
| | Simulated roller lever | 0.54N | AVM36453 | AVM37453 | AVM38453 |
| | Roller lever | 0.59N | AVM36553 | AVM37553 | AVM38553 |
| Gold-clad triple layer contact type | Pin plunger | 1.47N | AVM3605613 | AVM3705613 | AVM3805613 |
| | Short hinge lever | 0.59N | AVM3615613 | AVM3715613 | AVM3815613 |
| | Hinge lever | 0.54N | AVM3625613 | AVM3725613 | AVM3825613 |
| | Long hinge lever | 0.44N | AVM3635613 | AVM3735613 | AVM3835613 |
| | Simulated roller lever | 0.54N | AVM3645613 | AVM3745613 | AVM3845613 |
| | Roller lever | 0.59N | AVM3655613 | AVM3755613 | AVM3855613 |

Remark: When ordering, please refer to "Remarks" of ordering information.

4. FS-T switches (Cross-line terminal type)

Long life version

| | Actuator | Operating force, Max. | Part No. | | |
|-------------------------------------|------------------------|-----------------------|-------------------------------|-------------|-----------------------------|
| | | | Solder terminal Without guard | PC terminal | .110 Quick-connect terminal |
| AgNi alloy contact type | Pin plunger | 1.47N | AVL32053 | AVL34053 | AVL38053 |
| | Short hinge lever | 0.59N | AVL32153 | AVL34153 | AVL38153 |
| | Hinge lever | 0.54N | AVL32253 | AVL34253 | AVL38253 |
| | Long hinge lever | 0.44N | AVL32353 | AVL34353 | AVL38353 |
| | Simulated roller lever | 0.54N | AVL32453 | AVL34453 | AVL38453 |
| | Roller lever | 0.59N | AVL32553 | AVL34553 | AVL38553 |
| Gold-clad triple layer contact type | Pin plunger | 1.47N | AVL3205613 | AVL3405613 | AVL3805613 |
| | Short hinge lever | 0.59N | AVL3215613 | AVL3415613 | AVL3815613 |
| | Hinge lever | 0.54N | AVL3225613 | AVL3425613 | AVL3825613 |
| | Long hinge lever | 0.44N | AVL3235613 | AVL3435613 | AVL3835613 |
| | Simulated roller lever | 0.54N | AVL3245613 | AVL3445613 | AVL3845613 |
| | Roller lever | 0.59N | AVL3255613 | AVL3455613 | AVL3855613 |

Remark: When ordering, please refer to "Remarks" of ordering information.

AV3,AVM3/AVT3,AVL3

SPECIFICATIONS

1.Contact rating

| Voltage | Standard version | | | Long life version | | |
|---------|--|--|------------------------|--|--|------------------------|
| | AgNi alloy contact type | | Gold-clad contact type | AgNi alloy contact type | | Gold-clad contact type |
| | Resistive load ($\cos\phi \approx 1$) | Inductive load ($\cos\phi \approx 0.6-0.7$) | Triple layer | Resistive load ($\cos\phi \approx 1$) | Inductive load ($\cos\phi \approx 0.6-0.7$) | Triple layer |
| 125V AC | 3A | 2A | 0.1A | 5A | 3A | 0.1A |
| 250V AC | 3A | 2A | 0.1A | 5A | 3A | 0.1A |
| 30V DC | 3A | 2A | 0.1A | 5A | 3A | 0.1A |
| 125V DC | 0.4A | 0.05A | — | 0.4A | 0.05A | — |

Remark: Time constant shall be less than 7 msec. for DC inductive loads.

2.Characteristics

| | Standard version | | Long life version | |
|---|--|---|--|---------------------------|
| | AgNi alloy contact type | Gold-clad contact type | AgNi alloy contact type | Gold-clad contact type |
| Electrical life at rated load (O.T.max.) | 5×10^4 at 20 cpm | 2×10^5 at 20 cpm | 5×10^4 at 20 cpm | 2×10^5 at 20 cpm |
| Mechanical life | 5×10^5 at 60 cpm (O.T.max.) | | 3×10^7 (O.T.: Specified value) 10^7 (O.T.max.) at 60 cpm | |
| Insulation resistance | Min.100M Ω at 500V DC | | | |
| Dielectric strength | 1,000 Vrms | | | |
| Between non-continuous terminals | 1,500 Vrms | | | |
| Between each terminal and other exposed metal parts | 1,500 Vrms | | | |
| Between each terminal and ground | 1,500 Vrms | | | |
| Vibration resistance (Pin plunger type) | 10 to 55 Hz at single amplitude of 1.5mm (Contact opening: max.1 msec.) | | | |
| Shock resistance (Pin plunger type) (Contact opening: less than 1 msec.) | 294 m/s ² min. (O.F. 0.98 N) 147 m/s ² min. (O.F. 0.49 N) | 294 m/s ² min. (O.F. 0.98 N) 147 m/s ² min. (O.F. 0.49 N) 49 m/s ² min. (O.F. 0.25 N) | 294 m/s ² min. | |
| Contact resistance (Initial) | 50 m Ω max. (by voltage drop 1 A 6 to 8V DC) | 100 m Ω max. (by voltage drop 0.1 A 6 to 8V DC) | Au: 50 m Ω max. (by voltage drop 0.1 A 6 to 8V DC) Ag: 50 m Ω max. (by voltage drop 1 A 6 to 8V DC) | |
| Allowable operating speed | 0.1 to 1,000 mm/sec. | | | |
| Max.operating cycle rate | 300 cpm | | | |
| Ambient temperature | -25°C to +85°C (no freezing below 0°C) | | | |
| Unit weight | Approx.2g | | | |

3.Operating characteristics

1) Pin plunger

| 4th digit number of Part No. | O.F.max. | R.F.min. | P.T.max. | M.D.max. | O.T.max. | O.P. |
|------------------------------|----------|----------|----------|----------|----------|---|
| 0 | 0.25N | 0.020N | 0.6mm | 0.1mm | 0.4mm | Distance from mounting holes: 8.4±0.3mm Distance from stand-off: FS 11.8±0.4mm FS-T 11.7±0.4mm |
| 2 | 0.49N | 0.074N | | | | |
| 4 | 0.98N | 0.15N | | | | |
| 5 | 1.47N | 0.20N | | | | |

2) Short hinge lever

| 4th digit number of Part No. | O.F.max. | R.F.min. | P.T.max. | M.D.max. | O.T.max. | O.P. |
|------------------------------|----------|----------|----------|----------|----------|---|
| 0 | 0.098N | 0.004N | 2.5mm | 0.5mm | 0.8mm | Distance from mounting holes: 8.8±0.8mm Distance from stand-off: FS 12.2±0.9mm FS-T 12.1±0.9mm |
| 2 | 0.20N | 0.017N | | | | |
| 4 | 0.39N | 0.034N | | | | |
| 5 | 0.59N | 0.039N | | | | |

3) Hinge lever

| 4th digit number of Part No. | O.F.max. | R.F.min. | P.T.max. | M.D.max. | O.T.max. | O.P. |
|------------------------------|----------|----------|----------|----------|----------|---|
| 0 | 0.078N | 0.003N | 2.8mm | 0.8mm | 1.2mm | Distance from mounting holes: 8.8±0.8mm Distance from stand-off: FS 12.2±0.9mm FS-T 12.1±0.9mm |
| 2 | 0.16N | 0.015N | | | | |
| 4 | 0.34N | 0.029N | | | | |
| 5 | 0.54N | 0.034N | | | | |

4) Long hinge lever

| 4th digit number of Part No. | O.F.max. | R.F.min. | P.T.max. | M.D.max. | O.T.max. | O.P. |
|------------------------------|----------|----------|----------|----------|----------|---|
| 0 | — | — | 3.5mm | 1.0mm | 1.6mm | Distance from mounting holes: 8.8±1.2mm Distance from stand-off: FS 12.2±1.3mm FS-T 12.1±1.3mm |
| 2 | 0.12N | 0.012N | | | | |
| 4 | 0.25N | 0.025N | | | | |
| 5 | 0.44N | 0.029N | | | | |

5) Simulated roller lever

| 4th digit number of Part No. | O.F.max. | R.F.min. | P.T.max. | M.D.max. | O.T.max. | O.P. |
|------------------------------|----------|----------|----------|----------|----------|---|
| 0 | — | — | 2.8mm | 0.8mm | 1.2mm | Distance from mounting holes: 11.65±0.8mm Distance from stand-off: FS 15.05±0.9mm FS-T 14.95±0.9mm |
| 2 | 0.16N | 0.015N | | | | |
| 4 | 0.34N | 0.029N | | | | |
| 5 | 0.54N | 0.034N | | | | |

6) Roller lever

| 4th digit number of Part No. | O.F.max. | R.F.min. | P.T.max. | M.D.max. | O.T.max. | O.P. |
|------------------------------|----------|----------|----------|----------|----------|--|
| 0 | — | — | 2.5mm | 0.5mm | 0.8mm | Distance from mounting holes: 14.5±0.8mm Distance from stand-off: FS 17.9±0.9mm FS-T 17.8±0.9mm |
| 2 | 0.20N | 0.017N | | | | |
| 4 | 0.39N | 0.034N | | | | |
| 5 | 0.59N | 0.039N | | | | |

DIMENSIONS

The CAD data of the products with a **CAD Data** mark can be downloaded from: <http://industrial.panasonic.com/ac/e>

1. FS switches (In-line terminal type)

mm General tolerance: ±0.25

1-(1) Solder terminal (without guard)

CAD Data



Dimensions other than drawn above is same as self-standing PC board terminal.

AV3,AVM3/AVT3,AVL3

1-(2) Solder terminal (with guard)

mm General tolerance: ± 0.25

CAD Data



Dimensions other than drawn above is same as guardless type.

1-(3) Solder terminal (with opposite side guard)

CAD Data



Dimensions other than drawn above is same as guardless type.

1-(4) Self-standing PC terminal

Pin plunger

CAD Data



PC board pattern

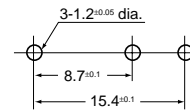

| | | |
|--------------------------------|---------------------------------|----------|
| Pretravel, Max. mm | 0.6 | |
| Movement differential, Max. mm | 0.1 | |
| Overtravel, Min. mm | 0.4 | |
| Operating position | Distance from mounting hole, mm | 8.4±0.3 |
| | Distance from standoff, mm | 11.8±0.4 |

Short hinge lever

CAD Data



| | | |
|--------------------------------|---------------------------------|----------|
| Pretravel, Max. mm | 2.5 | |
| Movement differential, Max. mm | 0.5 | |
| Overtravel, Min. mm | 0.8 | |
| Operating position | Distance from mounting hole, mm | 8.8±0.8 |
| | Distance from standoff, mm | 12.2±0.9 |

Hinge lever

CAD Data

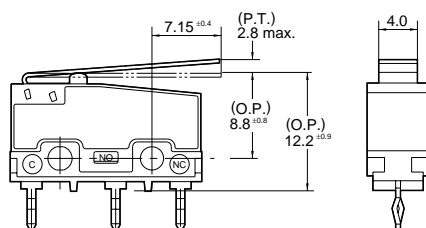

| | | |
|--------------------------------|---------------------------------|----------|
| Pretravel, Max. mm | 2.8 | |
| Movement differential, Max. mm | 0.8 | |
| Overtravel, Min. mm | 1.2 | |
| Operating position | Distance from mounting hole, mm | 8.8±0.8 |
| | Distance from standoff, mm | 12.2±0.9 |

AV3,AVM3/AVT3,AVL3

mm General tolerance: ±0.25

Long hinge lever

CAD Data



| | | |
|--------------------------------|---------------------------------|----------|
| Pretravel, Max. mm | 3.5 | |
| Movement differential, Max. mm | 1.0 | |
| Overtravel, Min. mm | 1.6 | |
| Operating position | Distance from mounting hole, mm | 8.8±1.2 |
| | Distance from standoff, mm | 12.2±1.3 |

Simulated roller lever

CAD Data



| | | |
|--------------------------------|---------------------------------|-----------|
| Pretravel, Max. mm | 2.8 | |
| Movement differential, Max. mm | 0.8 | |
| Overtravel, Min. mm | 1.2 | |
| Operating position | Distance from mounting hole, mm | 11.65±0.8 |
| | Distance from standoff, mm | 15.05±0.9 |

Roller lever

CAD Data

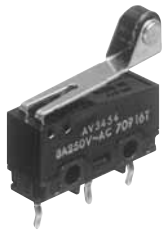

| | | |
|--------------------------------|---------------------------------|----------|
| Pretravel, Max. mm | 2.5 | |
| Movement differential, Max. mm | 0.5 | |
| Overtravel, Min. mm | 0.8 | |
| Operating position | Distance from mounting hole, mm | 14.5±0.8 |
| | Distance from standoff, mm | 17.9±0.9 |

1-(5) Internationally common pitch PC terminal

CAD Data



PC board pattern

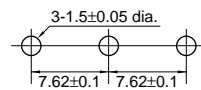

1-(6) Right angle terminal

CAD Data

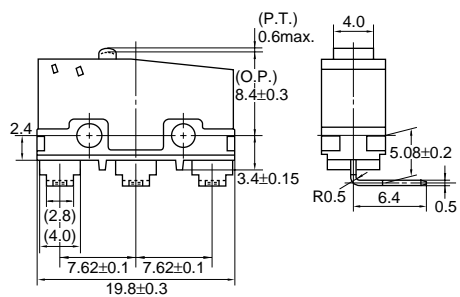

PC board pattern

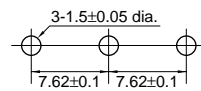

AV3,AVM3/AVT3,AVL3

1-(7) Left angle terminal

mm General tolerance: ± 0.25

CAD Data

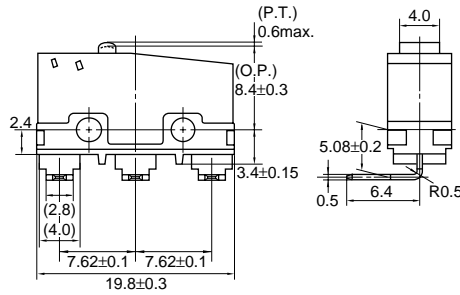

PC board pattern



1-(8) .110 Quick-connect terminal

CAD Data



Dimensions other than drawn above is same as self-standing PC board terminal.

2.FS-T switches (Cross-line terminal type)

2-(1) PC board terminal

Pin plunger

CAD Data

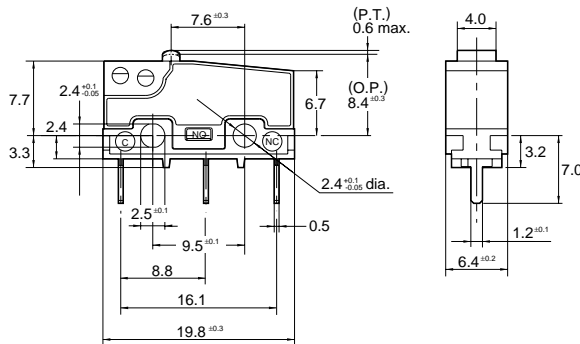

PC board pattern



| | | |
|--------------------------------|---------------------------------|----------|
| Pretravel, Max. mm | 0.6 | |
| Movement differential, Max. mm | 0.1 | |
| Overtravel, Min. mm | 0.4 | |
| Operating position | Distance from mounting hole, mm | 8.4±0.3 |
| | Distance from standoff, mm | 11.7±0.4 |

Short hinge lever

CAD Data



| | | |
|--------------------------------|---------------------------------|----------|
| Pretravel, Max. mm | 2.5 | |
| Movement differential, Max. mm | 0.5 | |
| Overtravel, Min. mm | 0.8 | |
| Operating position | Distance from mounting hole, mm | 8.8±0.8 |
| | Distance from standoff, mm | 12.1±0.9 |

AV3,AVM3/AVT3,AVL3

mm General tolerance: ±0.25

Hinge lever

CAD Data



| | | |
|--------------------------------|---------------------------------|----------|
| Pretravel, Max. mm | | 2.8 |
| Movement differential, Max. mm | | 0.8 |
| Overtravel, Min. mm | | 1.2 |
| Operating position | Distance from mounting hole, mm | 8.8±0.8 |
| | Distance from standoff, mm | 12.1±0.9 |

Long hinge lever

CAD Data



| | | |
|--------------------------------|---------------------------------|----------|
| Pretravel, Max. mm | | 3.5 |
| Movement differential, Max. mm | | 1.0 |
| Overtravel, Min. mm | | 1.6 |
| Operating position | Distance from mounting hole, mm | 8.8±1.2 |
| | Distance from standoff, mm | 12.1±1.3 |

Simulated roller lever

CAD Data

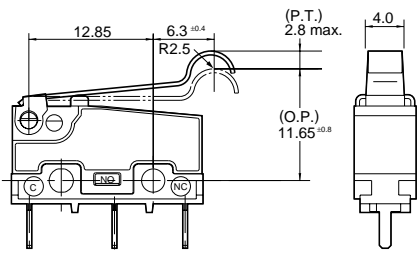
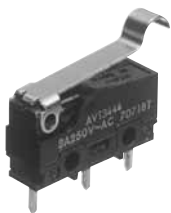

| | | |
|--------------------------------|---------------------------------|-----------|
| Pretravel, Max. mm | | 2.8 |
| Movement differential, Max. mm | | 0.8 |
| Overtravel, Min. mm | | 1.2 |
| Operating position | Distance from mounting hole, mm | 11.65±0.8 |
| | Distance from standoff, mm | 14.95±0.9 |

Roller lever

CAD Data



| | | |
|--------------------------------|---------------------------------|----------|
| Pretravel, Max. mm | | 2.5 |
| Movement differential, Max. mm | | 0.5 |
| Overtravel, Min. mm | | 0.8 |
| Operating position | Distance from mounting hole, mm | 14.5±0.8 |
| | Distance from standoff, mm | 17.8±0.9 |

2-(2) Solder terminal

CAD Data



As for the dimensions of lever types, dimensions other than terminals are same as self-standing solder terminal.

AV3,AVM3/AVT3,AVL3

2-(3) .110 Quick-connect terminal

mm General tolerance: ± 0.25

CAD Data

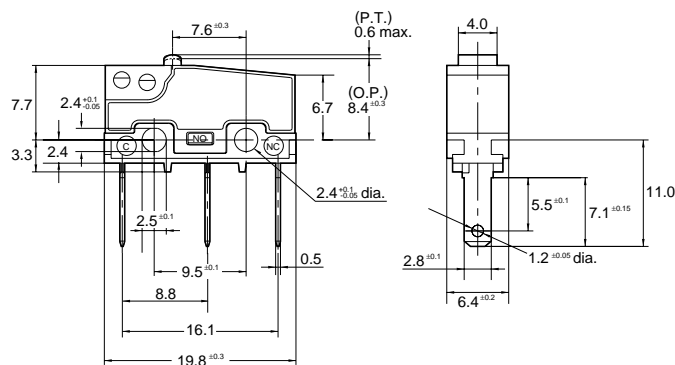

As for the dimensions of lever types, dimensions other than terminals are same as self-standing solder terminal.

NOTES

1.Regarding fastening of switch body

In fastening the switch body, use flat filister head M2.3 screws, with tightening torque of not more than 0.29N·m. To prevent loosening of the screws, it is recommended that spring washers be used with the screws and adhesive be applied to lock the screws. After mounting the switch and making wiring connections, the insulation distance between ground and each terminal should be confirmed as sufficient.

The positioning of the switch should be such that the pushbutton or actuator for the switch should not directly apply force to the operating section in the free condition. For a pushbutton, the force from the pushbutton should be applied in a perpendicular direction.

In setting the movement after operation, the over-travel should be set not less than 70% as a standard. Setting the movement at less than 70% of O.T. may cause troubles such as mis-contact and welding due to small contact force of the switch.

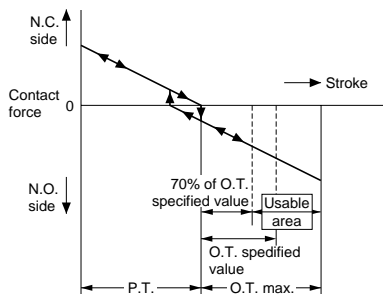

2.Soldering operation

Manual soldering should be accomplished within 3 seconds with max. 350°C iron.

Care should be taken not to apply force to the terminals during soldering. Terminal portions must not be moved in min. 1 minute after soldering. Also no tensile strength of lead wires should be applied to terminals.

3.Regarding connector connections (.110 quick connect terminals)

For making connections, a dedicated receptacle for .110 quick connect terminals should be used, and the terminals should be inserted parallel to the receptacle. Consideration should be given to mounting so that no tensile load is applied to the lead wires.

4.In making the switch selection

Consideration should be given to provide for no interference up to +20% variation of the standard characteristics values.

5.Environment

Locations where corrosive gases having a bad influence on contacts are present, and locations where there is an excessive amount of siliceous or other abrasive dust should be avoided.

6.Cautions regarding use

This subminiature switch has been designed as a dedicated switch for AC use, but it can be used for low capacity DC circuits.

Please select gold-clad contact types when loads are in the low-level area of 1mA up to 100mA and 5V up to 30V.

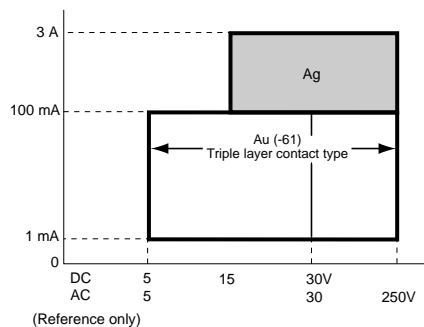

For switching of inductive loads (relays, solenoids, buzzers, etc.), in order to prevent damage to contacts due to the occurrence of arcing, an arc absorbing circuit should be applied.

7.Quality check under Actual Loading Condition

To assure reliability, check the switch under actual loading conditions. Avoid any situation that may adversely affect switching performance.

8.When using lever type switch, care should be taken not to apply undue force on the body from the opposite side or side ways to its operating direction.

X-ON Electronics

Largest Supplier of Electrical and Electronic Components

Click to view similar products for [Basic / Snap Action Switches](#) category:

Click to view products by [Panasonic](#) manufacturer:

Other Similar products are found below :

[5SM901-S12](#) [5SM9-S12N195](#) [602EN532](#) [602EN535-RB](#) [602HE5-RB1](#) [604HE162](#) [604HE223-6B](#) [624HE17-RB](#) [6HM82](#) [6HM89](#) [6SE1](#)
[6SX1-H58](#) [70500216](#) [70599106](#) [MBD5B1](#) [MBH2731](#) [73-316-0012](#) [EXD-AR20](#) [79211923](#) [79218589](#) [7AS12](#)
[MIL30126AB6BBMD4A12XAU](#) [ML-1155](#) [ML-1376](#) [831010C3.0](#) [831090C2.EL](#) [83131904](#) [84212012](#) [8AS239](#) [8HM73-3](#) [8SX26-H33](#)
[914CE1-6G](#) [PL-100](#) [11SM1077-H4](#) [11SM1077-H58](#) [11SM1-TN107](#) [11SM405](#) [11SM8423-H2](#) [11SX37-T](#) [11SX48-H58](#) [11SM2442-T](#)
[11SM76-T](#) [11SM77-H58](#) [11SM77-T](#) [11SM863-T](#) [11SM866](#) [A7CN-1M-1-LEFT](#) [A831700C7.0](#) [121EN187-R](#) [121EN188-R](#)