

For board-to-board | For board-to-FPC

**Narrow pitch connectors
(0.4mm pitch)**

P4S Series

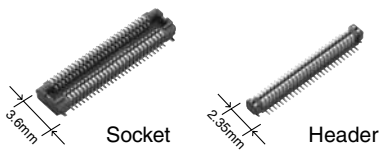

RoHS compliant

FEATURES

1. Space-saving (3.6 mm widthwise)
Smaller compared to P4 with soldering terminals (30 pin contacts):

Socket — 38% smaller,
Header — 34% smaller

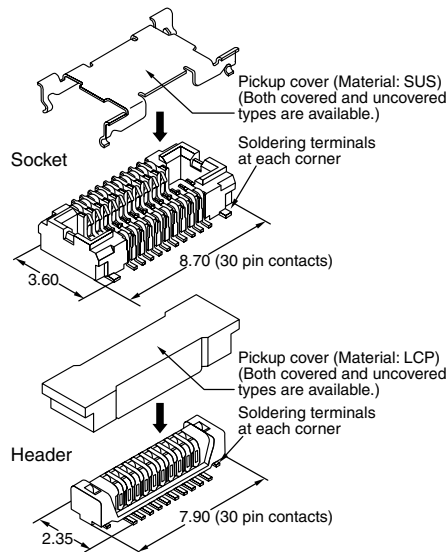

2. Strong resistance to adverse environments! Utilizes “TOUGH CONTACT” construction for high contact reliability.

3. Greater flexibility in connector placement.

Pattern wiring to the connector bottom is made possible with a molded covering on the undersurface of the connector.

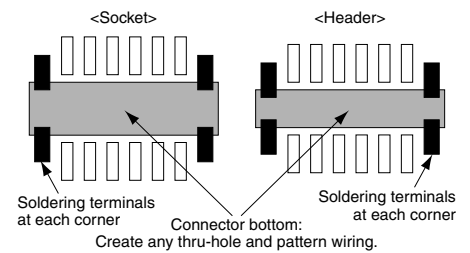

4. Connectors for inspection available
5. Shield socket is also available.

APPLICATIONS

Mobile devices, such as tablet PC, note PC, digital still cameras (DSC) and digital video cameras (DVC).

ORDERING INFORMATION

AXT [] [] [] [] [] **4**

3: Narrow Pitch Connector P4S (0.4 mm pitch) Socket
4: Narrow Pitch Connector P4S (0.4 mm pitch) Header

Number of pins (2 digits)

Mated height

<Socket>

1: For mated height 1.5 mm and 2.0 mm

2: For mated height 2.5 mm and 3.0 mm

<Header>

1: For mated height 1.5 mm and 2.5 mm

2: For mated height 2.0 mm

3: For mated height 3.0 mm

Functions

<Socket/Header>

2: Without pickup cover, without positioning bosses

6: With pickup cover, without positioning bosses

Surface treatment (Contact portion / Terminal portion)

<Socket> 4: Ni plating on base, Au plating on surface (for Ni barrier available)

<Header> 4: Ni plating on base, Au plating on surface

PRODUCT TYPES 

Mated height	Number of pins	Part number		Packing	
		Socket	Header	Inner carton	Outer carton
1.5mm	10	AXT310124	AXT410124	3,000 pieces	6,000 pieces
	16	AXT316124	AXT416124		
	20	AXT320124	AXT420124		
	22	AXT322124	AXT422124		
	24	AXT324124	AXT424124		
	26	AXT326124	AXT426124		
	30	AXT330124	AXT430124		
	32	AXT332124	AXT432124		
	34	AXT334124	AXT434124		
	36	AXT336124	AXT436124		
	38	AXT338124	AXT438124		
	40	AXT340124	AXT440124		
	44	AXT344124	AXT444124		
	46	AXT346124	AXT446124		
	50	AXT350124*	AXT450124		
	54	AXT354124	AXT454124		
	60	AXT360124	AXT460124		
	64	AXT364124	AXT464124		
	2.0mm	30	AXT330124		
40		AXT340124	AXT440224		
90		AXT390124	AXT490224		
100		AXT300124	AXT400224		
2.5mm	20	AXT320224	AXT420124	3,000 pieces	6,000 pieces
	30	AXT330224	AXT430124		
	40	AXT340224	AXT440124		
	60	AXT360224	AXT460124		
	100	AXT300224	AXT400124		
3.0mm	20	AXT320224	AXT420324	3,000 pieces	6,000 pieces
	30	AXT330224	AXT430324		
	60	AXT360224	AXT460324		
	80	AXT380224	AXT480324		
	100	AXT300224	AXT400324		

- Notes: 1. Regarding ordering units; During production: Please make orders in 1-reel units.
 Samples for mounting confirmation: Available in units of 50 pieces. Please contact our sales office.
 Samples: Small lot orders are possible. Please consult us.
2. If you require the pickup cover, change the eighth digit of the part number from "2" to "6" in your order. Note that the pickup cover is not available for some types depending on the number of pins. Check the latest product specifications.
3. The above part numbers are for connectors without positioning bosses, which are standard. When ordering connectors with positioning bosses, please contact our sales office.

* The product is compatible with a shield if you select "AXT3501F4" as the socket side part number. Please see the web catalog for more information about shield compatible products.

SPECIFICATIONS

1. Characteristics

Item		Specifications	Conditions		
Electrical characteristics	Rated current	0.3A/pin contact (Max. 5 A at total pin contacts)	—		
	Rated voltage	60V AC/DC	—		
	Breakdown voltage	150V AC for 1 min.	Rated voltage is applied for one minute and check for short circuit or damage with a detection current of 1mA.		
	Insulation resistance	Min. 1,000MΩ (initial)	Using 250V DC megger (applied for 1 min.)		
	Contact resistance	Max. 90mΩ	Based on the contact resistance measurement method specified by JIS C 5402.		
Mechanical characteristics	Composite insertion force	Max. 0.981N/pin contacts × pin contacts (initial)			
	Composite removal force	Min. 0.0588N/pin contacts × pin contacts			
Environmental characteristics	Contact holding force (Socket contact)	Min. 0.981N/pin contacts	Measuring the maximum force. As the contact is axially pull out.		
	Ambient temperature	−55°C to +85°C	No freezing at low temperatures		
	Soldering heat resistance	Max. peak temperature of 260°C (on the surface of the PC board around the connector terminals) 300°C within 5 sec. or 350°C within 3 sec.	Infrared reflow soldering		
			Soldering iron		
	Storage temperature	−55°C to +85°C (product only) −40°C to +50°C (emboss packing)	No freezing at low temperatures		
	Thermal shock resistance (header and socket mated)	5 cycles, insulation resistance min. 100MΩ, contact resistance max. 90mΩ	Conformed to MIL-STD-202F, method 107G		
			Order	Temperature (°C)	Time (minutes)
			1	−55 $\frac{0}{-3}$	30
2			∩	Max. 5	
3	85 $\frac{+3}{0}$	30			
4	∩	Max. 5			
−55 $\frac{0}{-3}$					
Humidity resistance (header and socket mated)	120 hours, insulation resistance min. 100MΩ, contact resistance max. 90mΩ	Temperature 40±2°C, humidity 90 to 95% R.H.			
Saltwater spray resistance (header and socket mated)	24 hours, insulation resistance min. 100MΩ, contact resistance max. 90mΩ	Temperature 35±2°C, saltwater concentration 5±1%			
H ₂ S resistance (header and socket mated)	48 hours, contact resistance max. 90mΩ	Temperature 40±2°C, gas concentration 3±1 ppm, humidity 75 to 80% R.H.			
Lifetime characteristics	Insertion and removal life	50 times	Repeated insertion and removal speed of max. 200 times/hours		
Unit weight	Mated height 1.5mm, 20 pin contact type: Socket: 0.04 g Header: 0.02 g				

2. Material and surface treatment

Part name	Material	Surface treatment
Molded portion	LCP resin (UL94V-0)	—
Contact and Post	Copper alloy	Contact portion: Ni plating on base, Au plating on surface Terminal portion: Ni plating on base, Au plating on surface (Except for front edge of terminal) However, the area adjacent to the socket terminal is exposed to Ni on base. Soldering terminals portion; Socket: Ni plating on base, Pd + Au flash plating on surface (Expect for front edge of terminal) Header: Ni plating on base, Au plating on surface (Expect for front edge of terminal)

Narrow pitch connectors P4S (0.4mm pitch)

DIMENSIONS (Unit: mm)

The CAD data of the products with a **CAD Data** mark can be downloaded from: <http://industrial.panasonic.com/ac/e/>

1. Socket (Mated height: 1.5mm, 2.0mm, 2.5mm, 3.0mm)

- Without pickup cover

CAD Data

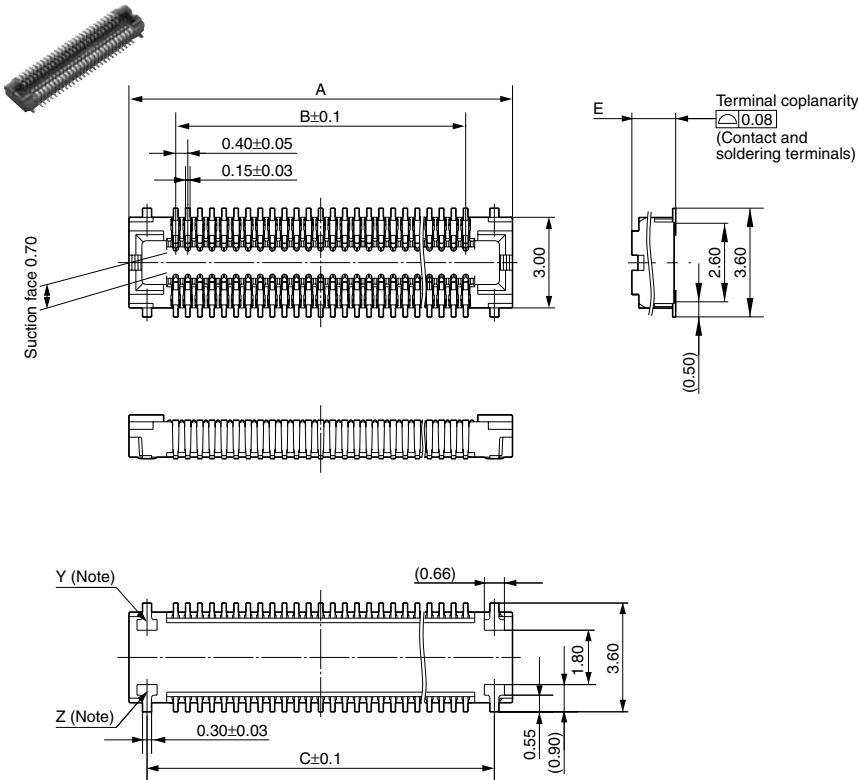

General tolerance: ± 0.2

Dimension table (mm)

Number of pins/ dimension	A	B	C
10	4.70	1.60	3.50
16	5.90	2.80	4.70
20	6.70	3.60	5.50
22	7.10	4.00	5.90
24	7.50	4.40	6.30
26	7.90	4.80	6.70
30	8.70	5.60	7.50
32	9.10	6.00	7.90
34	9.50	6.40	8.30
36	9.90	6.80	8.70
38	10.30	7.20	9.10
40	10.70	7.60	9.50
44	11.50	8.40	10.30
46	11.90	8.80	10.70
50	12.70	9.60	11.50
54	13.50	10.40	12.30
60	14.70	11.60	13.50
64	15.50	12.40	14.30
70	16.70	13.60	15.50
80	18.70	15.60	17.50
90	20.70	17.60	19.50
100	22.70	19.60	21.50

Mated height/ dimension	E
1.5mm	1.45
2.0mm	1.45
2.5mm	2.45
3.0mm	2.45

- With pickup cover

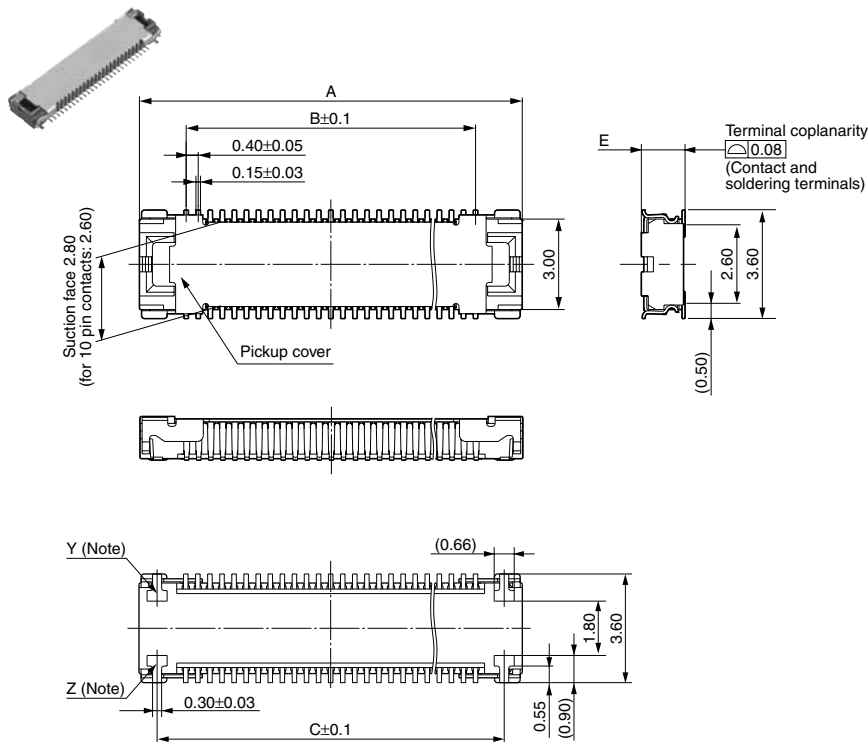

General tolerance: ± 0.2

Note: Since soldering terminals are built into the body, the Y and Z parts are connected electrically.

2. Header (Mated height: 1.5mm, 2.5mm)

- Without pickup cover

CAD Data

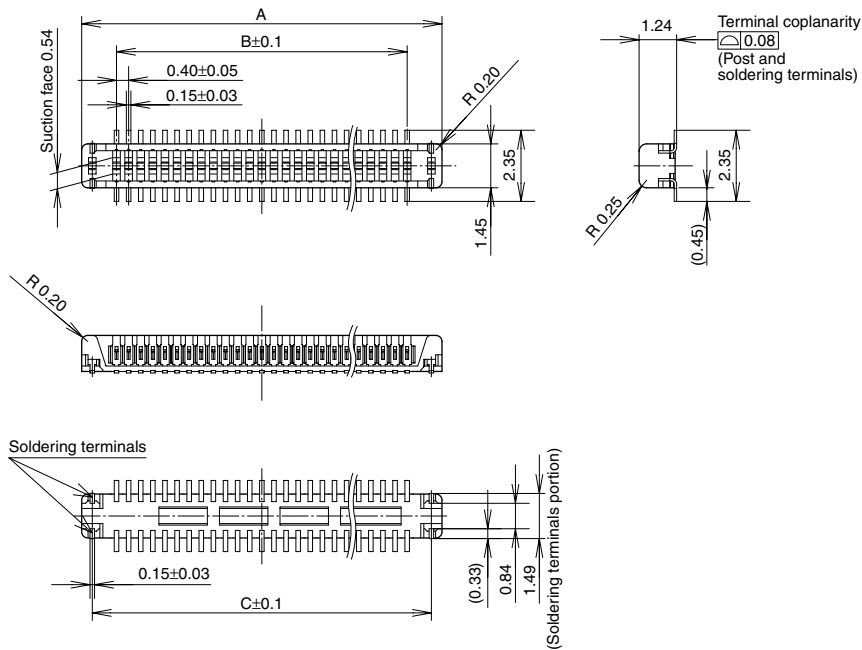

Dimension table (mm)

Number of pins/ dimension	A	B	C	D
10	3.90	1.60	3.20	5.40
16	5.10	2.80	4.40	6.60
20	5.90	3.60	5.20	7.40
22	6.30	4.00	5.60	7.80
24	6.70	4.40	6.00	8.20
26	7.10	4.80	6.40	8.60
30	7.90	5.60	7.20	9.40
32	8.30	6.00	7.60	9.80
34	8.70	6.40	8.00	10.20
36	9.10	6.80	8.40	10.60
38	9.50	7.20	8.80	11.00
40	9.90	7.60	9.20	11.40
44	10.70	8.40	10.00	12.20
46	11.10	8.80	10.40	12.60
50	11.90	9.60	11.20	13.40
54	12.70	10.40	12.00	14.20
60	13.90	11.60	13.20	15.40
64	14.70	12.40	14.00	—
70	15.90	13.60	15.20	17.40
80	17.90	15.60	17.20	19.40
90	19.90	17.60	19.20	21.40
100	21.90	19.60	21.20	23.40

General tolerance: ±0.2

- With pickup cover

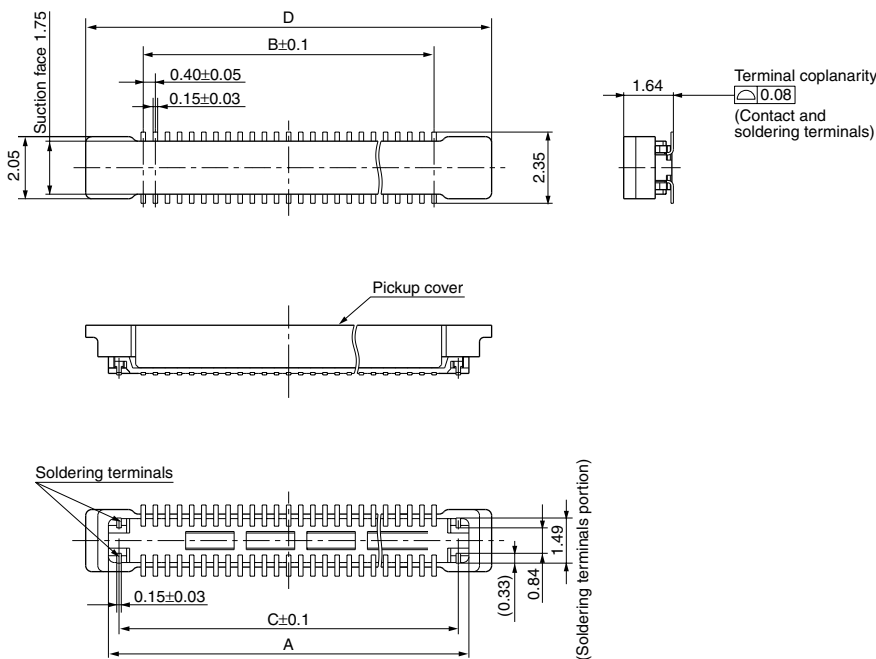

General tolerance: ±0.2

Note: The soldering terminal dimensions of headers with mated heights of 1.5mm/2.5mm and 2.0mm/3.0mm are different.

Narrow pitch connectors P4S (0.4mm pitch)

3. Header (Mated height: 2.0mm)

- Without pickup cover

CAD Data

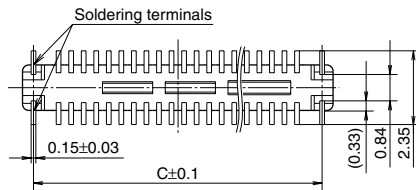
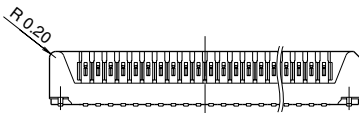
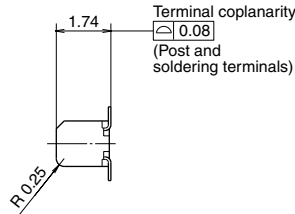
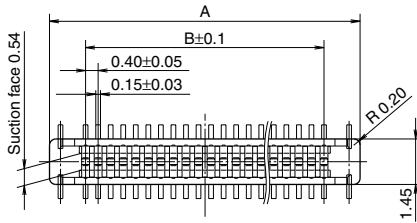

Dimension table (mm)

Number of pins/ dimension	A	B	C	D
30	7.90	5.60	7.20	—
40	9.90	7.60	9.20	11.40
90	19.90	17.60	19.20	21.40
100	21.90	19.60	21.20	—

General tolerance: ±0.2

- With pickup cover

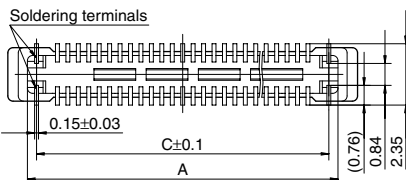
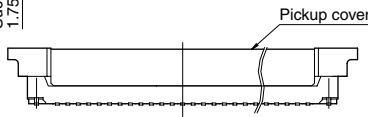
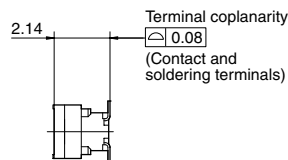
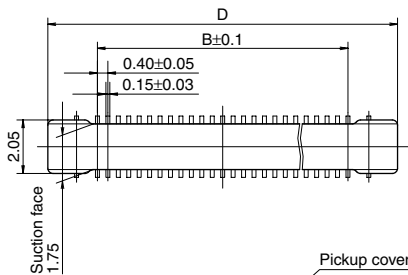

General tolerance: ±0.2

Note: The soldering terminals dimensions of headers with mated heights of 1.5mm/2.5mm and 2.0mm/3.0mm are different.

4. Header (Mated height: 3.0mm)

- Without pickup cover

CAD Data

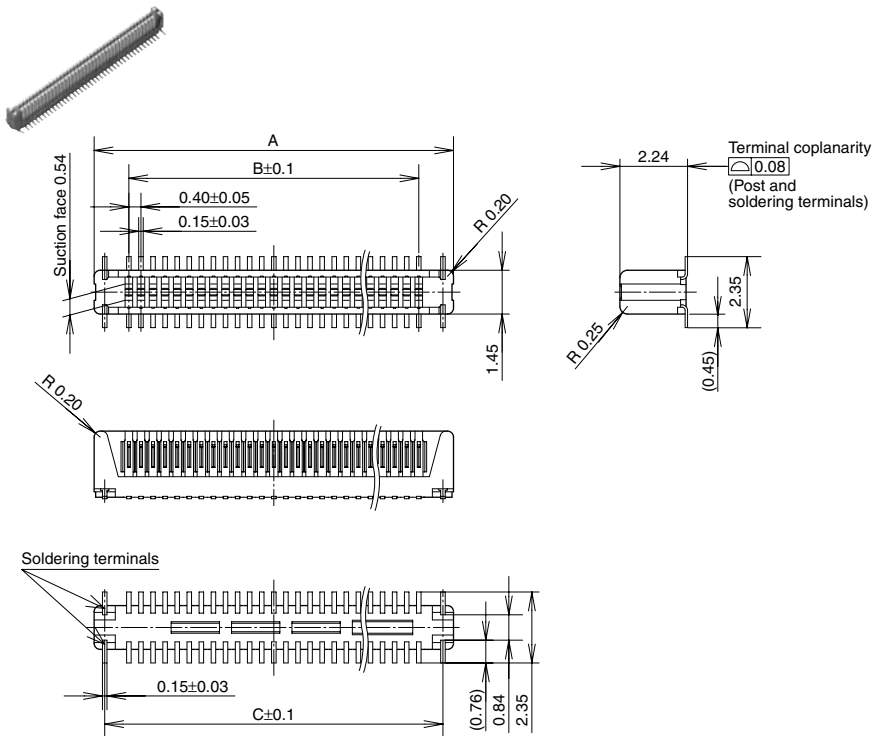

Dimension table (mm)

Number of pins/ dimension	A	B	C	D
20	5.90	3.60	5.20	—
30	7.90	5.60	7.20	9.40
60	13.90	11.60	13.20	—
80	17.90	15.60	17.20	19.40
100	21.90	19.60	21.20	—

General tolerance: ±0.2

- With pickup cover

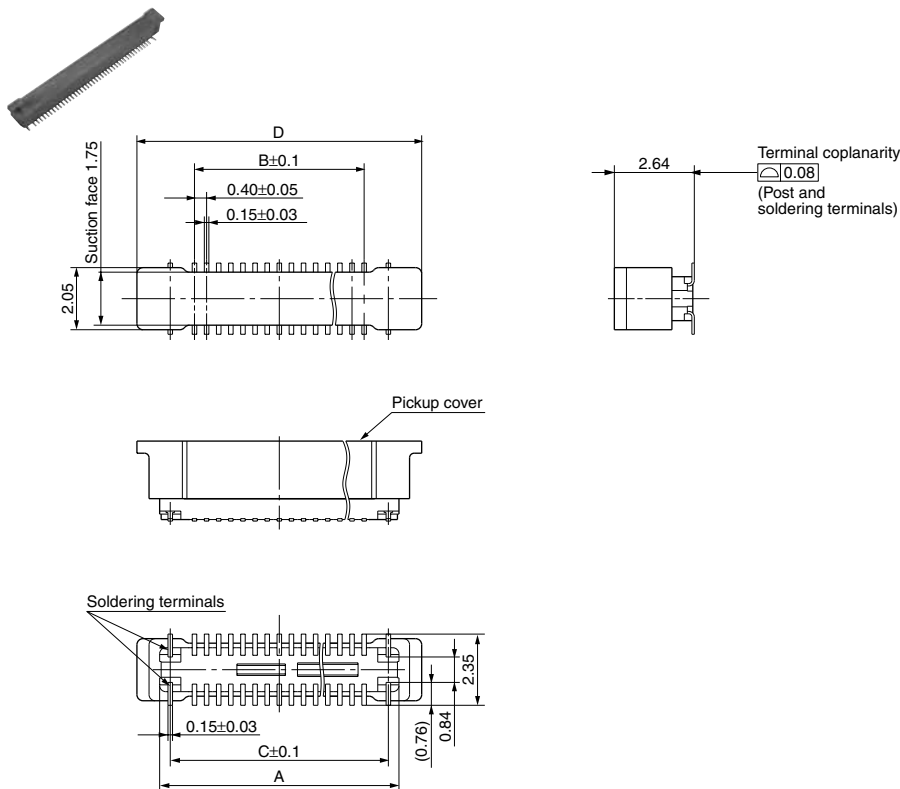

General tolerance: ±0.2

Note: The soldering terminals dimensions of headers with mated heights of 1.5mm/2.5mm and 2.0mm/3.0mm are different.

Narrow pitch connectors P4S (0.4mm pitch)

Socket and Header are mated

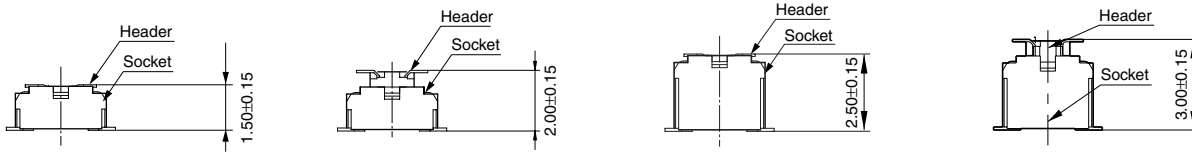

EMBOSSED TAPE DIMENSIONS (unit: mm, Common for respective contact type, socket and header)

• Tape dimensions (Conforming to JIS C 0806:1990.

• Plastic reel dimensions (Conforming to EIAJ ET-7200B)

However, some tapes have mounting hole pitches that do not comply with the standard.)

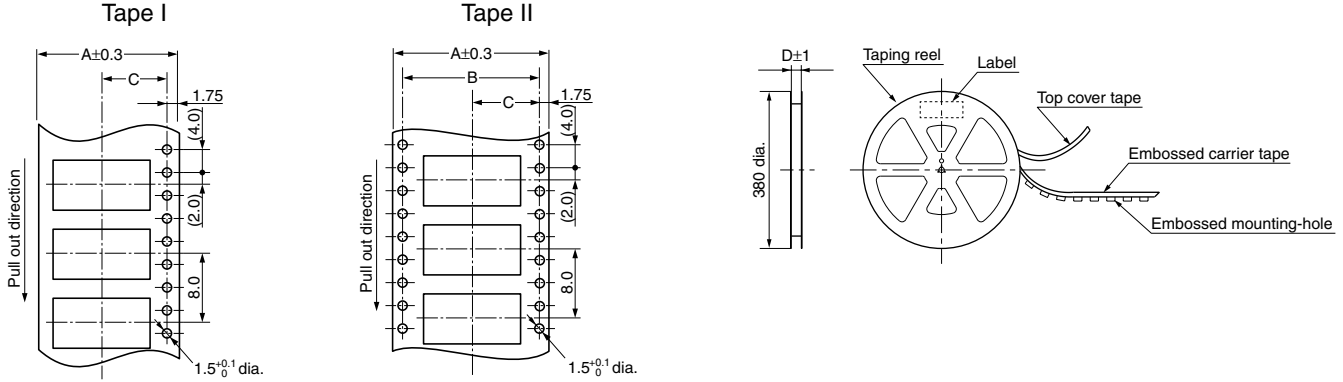

Dimension table (mm)

Mated height	Number of pins		Type of taping	A	B	C	D	Quantity per reel
	Socket (with/without pickup cover)	Header (with pickup cover)						
Common for socket and header: 1.5mm, 2.0mm, 2.5mm and 3.0mm	Max. 24	Max. 24	Tape I	16.0	—	7.5	17.5	3,000
	26 to 70	26 to 64	Tape I	24.0	—	11.5	25.5	3,000
	72 to 100	66 to 90	Tape II	32.0	28.4	14.2	33.5	3,000
	—	100	Tape II	44.0	40.4	20.2	45.5	3,000

Connector orientation with respect to direction of progress of embossed tape

Direction of tape progress	Type	Common for P4S	
	Socket	Header	
↓			

Note: There is no indication on this product regarding top-bottom or left-right orientation.

For board-to-board | For board-to-FPC

Connectors for inspection usage (0.4mm pitch)

P4S Series

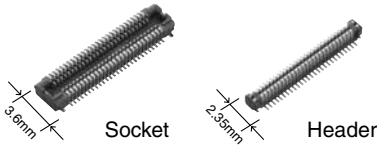

RoHS compliant

FEATURES

- 1. 3,000 mating and unmating cycles
- 2. Same external dimensions and foot pattern as standard type.
- 3. Improved mating

Insertion and removal easy due to a reduction in mating retention force. This is made possible by a simple locking structure design.

Note: Mating retention force cannot be warranted.

APPLICATIONS

Ideal for module unit inspection and equipment assembly inspection

TABLE OF PRODUCT TYPES

☆: Available for sale

Product name	Number of pins																			
P4S for inspection	10	16	20	22	24	26	30	32	34	36	38	40	44	50	54	60	70	80	90	100
	☆	☆	☆	☆	☆	☆	☆	☆	☆	☆	☆	☆	☆	☆	☆	☆	☆	☆	☆	☆

- Notes: 1. You can use with each mated height in common.
 2. The pickup surface shape of the inspection sockets is different from that of the standard sockets. (For details, refer to the product specification diagram.)
 3. Please inquire about number of pins other than those shown above.
 4. Please inquire with us regarding availability.
 5. Please keep the minimum order quantities no less than 50 pieces per lot.
 6. Please inquire if further information is needed.

PRODUCT TYPES

Specifications			Part No.	Specifications			Part No.
Socket	With pickup cover	Without positioning bosses	AXT3E**66	Header	With pickup cover	Without positioning bosses	AXT4E**66
	No pickup cover	Without positioning bosses	AXT3E**26		No pickup cover	Without positioning bosses	AXT4E**26

- Notes: 1. When placing an order, substitute the "*" (asterisk) in the above part number with the number of pins for the specific connector.
 2. The above part numbers are for connectors without positioning bosses, which are standard. When ordering connectors with positioning bosses, please contact our sales office.

NOTES

1. As shown below, excess force during insertion may result in damage to the connector or removal of the solder. Also, to prevent connector damage please confirm the correct position before mating connectors.

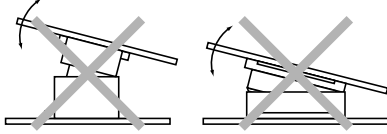

2. Keep the PC board warp no more than 0.03mm in relation to the overall length of the connector.

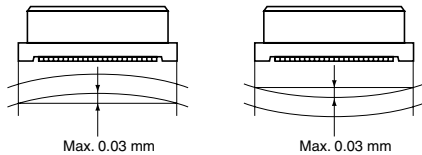

3. If extra resistance to shock caused by dropping is required, we recommend using P4 Series.

4. Recommended PC board and metal mask patterns

Connectors are mounted with high pitch density, intervals of 0.35 mm, 0.4 mm or 0.5 mm.

In order to reduce solder and flux rise, solder bridges and other issues make sure the proper levels of solder is used.

The figures to the right are recommended metal mask patterns. Please use them as a reference.

• **Socket (Mated height: 1.5mm, 2.0mm, 2.5mm and 3.0mm)**
Recommended PC board pattern (TOP VIEW)

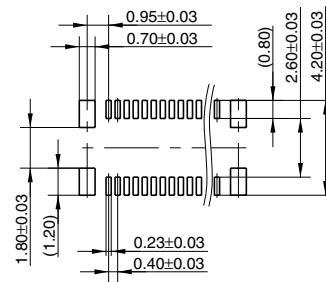

• **Shield socket (Mated height: 1.5 mm)**
Recommended PC board pattern (TOP VIEW)

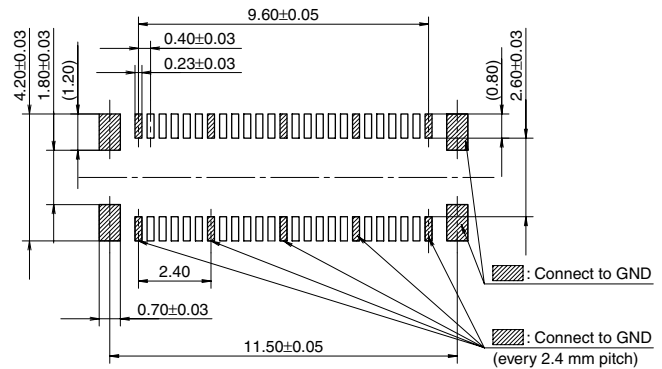

Recommended metal mask pattern (Shield socket can also be used)

Metal mask thickness: When 150 μm
(Terminal portion opening area ratio: 48%)
(Metal portion opening area ratio: 100%)

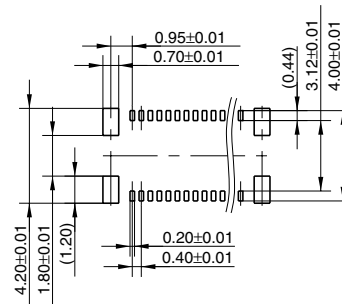

Recommended metal mask pattern (Shield socket can also be used)

Metal mask thickness: When 120 μm
(Terminal portion opening area ratio: 60%)
(Metal portion opening area ratio: 100%)

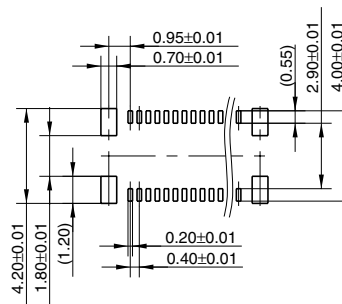

• Header (Mated height: 1.5mm and 2.5mm)
Recommended PC board pattern (TOP VIEW)

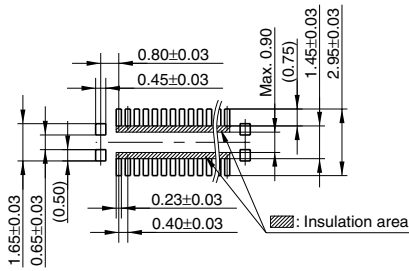

• Header (Mated height: 2.0mm, 3.0mm)
Recommended PC board pattern (TOP VIEW)

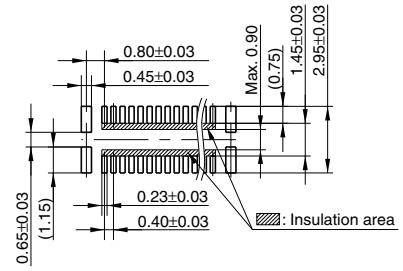

• Shield compatible header (Mated height: 1.5 mm)
Recommended PC board pattern (TOP VIEW)

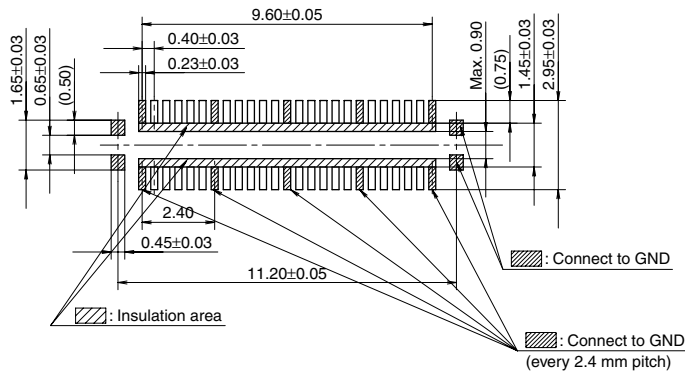

Recommended metal mask pattern
Metal mask thickness: When 150 μm
(Terminal portion opening area ratio: 49%)
(Metal portion opening area ratio: 100%)

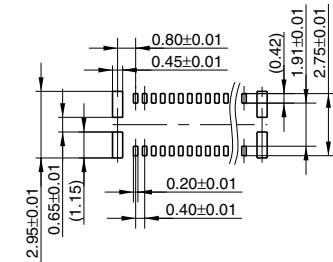

Recommended metal mask pattern
Metal mask thickness: When 120 μm
(Terminal portion opening area ratio: 60%)
(Metal portion opening area ratio: 100%)

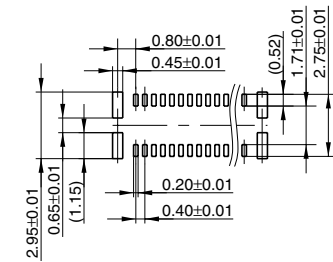

Recommended metal mask pattern (Shield socket can also be used)

Metal mask thickness: When 150 μm
(Terminal portion opening area ratio: 49%)
(Metal portion opening area ratio: 100%)

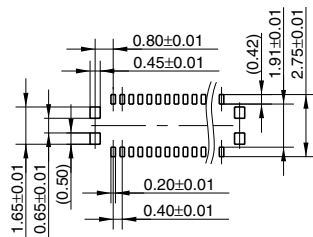

Recommended metal mask pattern (Shield socket can also be used)

Metal mask thickness: When 120 μm
(Terminal portion opening area ratio: 60%)
(Metal portion opening area ratio: 100%)

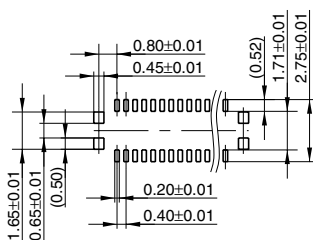

Note: The recommended PC board pattern diagrams and metal mask pattern diagrams for headers with mated heights of 1.5 mm/ 2.5 mm and 2.0 mm/3.0 mm are different.

Please see the web catalog for more information about shield compatible products.

Please refer to the latest product specifications when designing your product.

Notes on Using Narrow pitch Connectors

Regarding the design of devices and PC board patterns

1) When connecting several connectors together by stacking, make sure to maintain proper accuracy in the design of structure and mounting equipment so that the connectors are not subjected to twisting and torsional forces.

2) With mounting equipment, there may be up to a ± 0.2 to 0.3-mm error in positioning. Be sure to design PC boards and patterns while taking into consideration the performance and abilities of the required equipment.

3) Some connectors have tabs embossed on the body to aid in positioning. When using these connectors, make sure that the PC board is designed with positioning holes to match these tabs.

4) To ensure the required mechanical strength when soldering the connector terminals, make sure the PC board meets recommended PC board pattern design dimensions given.

5) For all connectors of the narrow pitch series, to prevent the PC board from coming off during vibrations or impacts, and to prevent loads from falling directly on the soldered portions, be sure to design some means to fix the PC board in place.

Example) Secure in place with screws

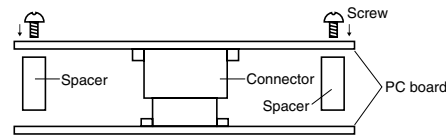

When connecting PC boards, take appropriate measures to prevent the connector from coming off.

6) Notes when using a FPC.

(1) When the connector is soldered to an FPC board, during its insertion and removal procedures, forces may be applied to the terminals and cause the soldering to come off. It is recommended to use a reinforcement board on the

backside of the FPC board to which the connector is being connected. Please make the reinforcement board dimensions bigger than the outer limits of the recommended PC board pattern (should be approximately 1 mm greater than the outer limit).

Material should be glass epoxy or polyimide, and the thickness should be between 0.2 and 0.3 mm.

(2) Collisions, impacts, or turning of FPC boards, may apply forces on the connector and cause it to come loose.

Therefore, make to design retaining plates or screws that will fix the connector in place.

7) The narrow pitch connector series is designed to be compact and thin.

Although ease of handling has been taken into account, take care when mating the connectors, as displacement or angled mating could damage or deform the connector.

Regarding the selection of the connector placement machine and the mounting procedures

1) Select the placement machine taking into consideration the connector height, required positioning accuracy, and packaging conditions.

2) Be aware that if the catching force of the placement machine is too great, it may deform the shape of the connector body or connector terminals.

3) Be aware that during mounting, external forces may be applied to the connector contact surfaces and terminals and cause deformations.

4) Depending on the size of the connector being used, self alignment may not be possible. In such cases, be sure to carefully position the terminal with the PC board pattern.

5) The positioning bosses give an approximate alignment for positioning on the PC board. For accurate positioning of the connector when mounting it to the PC board, we recommend using an automatic positioning machine.

6) Excessive mouter chucking force may deform the molded or metal part of the connector. Consult us in advance if chucking is to be applied.

Regarding soldering

1. Reflow soldering

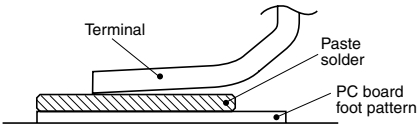
- 1) Measure the recommended profile temperature for reflow soldering by placing a sensor on the PC board near the connector surface or terminals. (The setting for the sensor will differ depending on the sensor used, so be sure to carefully read the instructions that comes with it.)
 - 2) As for cream solder printing, screen printing is recommended.
 - 3) To determine the relationship between the screen opening area and the PC-board foot pattern area, refer to the diagrams in the recommended patterns for PC boards and metal masks. Make sure to use the terminal tip as a reference position when setting. Avoid an excessive amount of solder from being applied, otherwise, interference by the solder will cause an imperfect contact.
- 
- 4) Consult us when using a screen-printing thickness other than that recommended.
 - 5) When mounting on both sides of the PC board and the connector is mounting on the underside, use adhesives or other means to ensure the connector is properly fixed to the PC board. (Double reflow soldering on the same side is possible.)
 - 6) N₂ reflow, conducting reflow soldering in a nitrogen atmosphere, increases the solder flow too greatly, enabling wicking to occur. Make sure that the solder feed rate and temperature profile are appropriate.

Soldering conditions

Please use the reflow temperature profile conditions recommended below for reflow soldering. Please contact us before using a temperature profile other than that described below (e.g. lead-free solder).

- Narrow pitch connectors (except P8 type)

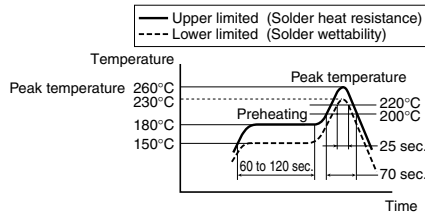

- Narrow pitch connector (P8)

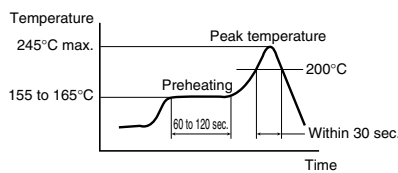

For products other than the ones above, please refer to the latest product specifications.

- 7) The temperatures are measured at the surface of the PC board near the connector terminals. (The setting for the sensor will differ depending on the sensor used, so be sure to carefully read the instructions that comes with it.)
- 8) The temperature profiles given in this catalog are values measured when using the connector on a resin-based PC board. When performed reflow soldering on a metal board (iron, aluminum, etc.) or a metal table to mount on a FPC, make sure there is no deformation or discoloration of the connector beforehand and then begin mounting.
- 9) Consult us when using a screen-printing thickness other than that recommended.
- 10) Some solder and flux types may cause serious solder or flux creeping. Solder and flux characteristics should be taken into consideration when setting the reflow soldering conditions.

2. Hand soldering

- 1) Set the soldering iron so that the tip temperature is less than that given in the table below.

Table A

Product name	Soldering iron temperature
SMD type connectors	300°C within 5 sec. 350°C within 3 sec.

- 2) Do not allow flux to spread onto the connector leads or PC board. This may lead to flux rising up to the connector inside.
- 3) Touch the soldering iron to the foot pattern. After the foot pattern and connector terminal are heated, apply the solder wire so it melts at the end of the connector terminals.

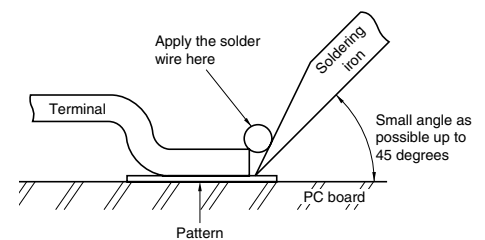

- 4) Be aware that soldering while applying a load on the connector terminals may cause improper operation of the connector.
- 5) Thoroughly clean the soldering iron.
- 6) Flux from the solder wire may get on the contact surfaces during soldering operations. After soldering, carefully check the contact surfaces and clean off any solder before use.
- 7) For soldering of prototype devices during product development, you can perform soldering at the necessary locations by heating with a hot-air gun by applying cream solder to the foot pattern beforehand. However, at this time, make sure that the air pressure does not move connectors by carefully holding them down with tweezers or other similar tool. Also, be careful not to go too close to the connectors and melt any of the molded components.
- 8) If an excessive amount of solder is applied during manual soldering, the solder may creep up near the contact points, or solder interference may cause imperfect contact.

3. Solder reworking

- 1) Finish reworking in one operation.
- 2) For reworking of the solder bridge, use a soldering iron with a flat tip. To prevent flux from climbing up to the contact surfaces, do not add more flux.
- 3) Keep the soldering iron tip temperature below the temperature given in Table A.

Handling Single Components

- 1) Make sure not to drop or allow parts to fall from work bench
- 2) Excessive force applied to the terminals could cause warping, come out, or weaken the adhesive strength of the solder. Handle with care.
- 3) Repeated bending of the terminals may cause terminals to break.

- 4) Do not insert or remove the connector when it is not soldered. Forcibly applied external pressure on the terminals can weaken the adherence of the terminals to the molded part or cause the terminals to lose their evenness.
- 5) Excessive prying-force applied to one end may cause product breakage and separation of the solder joints at the terminal.

Excessive force applied for insertion in a pivot action as shown may also cause product breakage. Align the header and socket positions before connecting them.

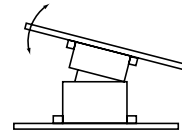

Cleaning flux from PC board

- 1) To increase the cleanliness of the cleaning fluid and cleaning operations, prepare equipment for cleaning process beginning with boil cleaning, ultrasonic cleaning, and then vapor cleaning.
- 2) Carefully oversee the cleanliness of the cleaning fluids to make sure that the contact surfaces do not become dirty from the cleaning fluid itself.

- 3) Since some powerful cleaning solutions may dissolve molded components of the connector and wipe off or discolor printed letters, we recommend aqua pura electronic parts cleaners. Please consult us if you wish to use other types of cleaning fluids.
- 4) Please note that the surfaces of molded parts may whiten when cleaned with alcohol.

Handling the PC board

• Handling the PC board after mounting the connector

When cutting or bending the PC board after mounting the connector, be careful that the soldered sections are subjected to excessive force.

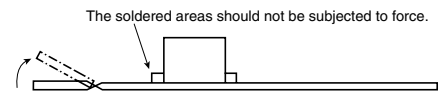

Storage of connectors

- 1) To prevent problems from voids or air pockets due to heat of reflow soldering, avoid storing the connectors in areas of high humidity. When storing the connectors for more than six months, be sure to consider storage area where the humidity is properly controlled.
- 2) Depending on the connector type, the color of the connector may vary from connector to connector depending on when it is produced.

- Some connectors may change color slightly if subjected to ultraviolet rays during storage. This is normal and will not affect the operation of the connector.
- 3) When storing the connectors with the PC boards assembled and components already set, be careful not to stack them up so the connectors are subjected to excessive forces.

- 4) Avoid storing the connectors in locations with excessive dust. The dust may accumulate and cause improper connections at the contact surfaces.

Other Notes

- 1) These products are made for the design of compact and lightweight devices and therefore the thickness of the molded components has been made very thin. Therefore, be careful during insertion and removal operations for excessive forces applied may damage the products.
- 2) Dropping of the products or rough mishandling may bend or damage the terminals and possibly hinder proper reflow soldering.

- 3) Before soldering, try not to insert or remove the connector more than absolutely necessary.
- 4) When coating the PC board after soldering the connector to prevent the deterioration of insulation, perform the coating in such a way so that the coating does not get on the connector.
- 5) There may be variations in the colors of products from different production lots. This is normal.

- 6) The connectors are not meant to be used for switching.
- 7) Be sure not to allow external pressure to act on connectors when assembling PCBs or moving in block assemblies.

Regarding sample orders to confirm proper mounting

When ordering samples to confirm proper mounting with the placement machine, connectors are delivered in 50-piece units in the condition given right. Consult a sale representative for ordering sample units.

Condition when delivered from manufacturing



Embossed tape amount required for the mounting

Required number of products for sample production (Unit 50 pcs.)

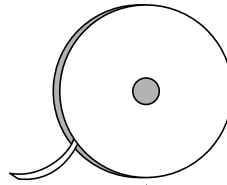

Reel

(Delivery can also be made on a reel by customer request.)

Please refer to the latest product specifications when designing your product.

X-ON Electronics

Largest Supplier of Electrical and Electronic Components

Click to view similar products for [Board to Board & Mezzanine Connectors](#) category:

Click to view products by [Panasonic](#) manufacturer:

Other Similar products are found below :

[589158040000018](#) [MDF7C-18P-2.54DSA\(55\)](#) [FCN-230C068-11](#) [FCN-268F012-G/BD](#) [FCN-268F036-G/BD](#) [FCN-268M012-G/0D](#) [FCN-268M024-G/1D](#) [FCN-723J004/1](#) [MIS-048-01-F-D-DP-K](#) [832-10-034-10-001000](#) [FX4C-80S-1.27DSA](#) [FCN-214Q030-G/0](#) [FCN-234P048-G/0](#) [FCN-235D050-G/C](#) [210-93-314-41-105000](#) [2-22603-0](#) [MDF7-40DP-2.54DSA\(55\)](#) [AXG720047](#) [5031084030](#) [MIT-114-03-F-D-K](#) [55323-1519](#) [DF33-2P-3.3DSA\(24\)](#) [YFT-20-05-H-03-SB-K](#) [503308-3040](#) [026-6203-PDB](#) [027-6203-PDB](#) [069159702701000](#) [10123981-102LF](#) [101A10019X](#) [55650-0588-C](#) [68682-310LF](#) [68684-306](#) [75140-7012](#) [87471-650](#) [194261-1](#) [FCN-268F024-G0D](#) [10124054-515LF](#) [68685-603](#) [8-1616154-3](#) [MIS-019-01-F-D](#) [FCN-268M024-G/3D](#) [FCN-268M036-G/BD](#) [20021832-06016C1LF](#) [KX15-20KLDL-E1000E](#) [AXE810124](#) [FCN-214J100-G/0](#) [FCN-230C068-E/S](#) [AXE812124](#) [AXE816124](#) [AXE720127](#)