



Compliant with European standards 1a/2a/1a1b 10A/8A polarized power relays

DE RELAYS



RoHS compliant

Protective construction: Sealed type

FEATURES

- 1. Conforms to European safety standard (VDE0700 and VDE0631)**
Insulating distance between coil and contacts:
Clearance Min. 8mm .315 inch
Creepage Min. 8mm .315 inch
- 2. Low operating power**
Nominal operating power at 200 mW (Single side stable, 2 coil latching)
- 3. Compact body saves space**
Size: 12.5(W) × 25(L) × 12.5(H) mm
.492(W) × .984(L) × .492(H) inch
- 4. Conforms to the various safety standards**
UL, C-UL and VDE approved

TYPICAL APPLICATIONS

1. Temperature controller
2. Automatic meter reading
3. OA equipment
4. FA equipment

ORDERING INFORMATION

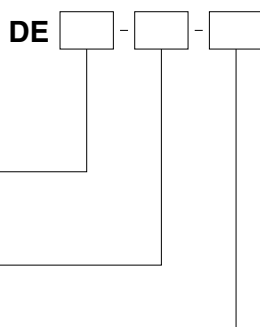

Contact arrangement
1a: 1 Form A
2a: 2 Form A
1a1b: 1 Form A 1 Form B

Operating function
Nil: Single side stable
L2: 2 coil latching

Nominal coil voltage (DC)
5, 12, 24V

Note: This product is manufactured by lot after an order is received.

TYPES

Contact arrangement	Nominal coil voltage	Part No.	
		Single side stable type	2 coil latching type
1 Form A	5V DC	DE1a-5V	DE1a-L2-5V
	12V DC	DE1a-12V	DE1a-L2-12V
	24V DC	DE1a-24V	DE1a-L2-24V
1 Form A 1 Form B	5V DC	DE1a1b-5V	DE1a1b-L2-5V
	12V DC	DE1a1b-12V	DE1a1b-L2-12V
	24V DC	DE1a1b-24V	DE1a1b-L2-24V
2 Form A	5V DC	DE2a-5V	DE2a-L2-5V
	12V DC	DE2a-12V	DE2a-L2-12V
	24V DC	DE2a-24V	DE2a-L2-24V

Standard packing: Tube package: 20 pcs.; Case: 500 pcs.
Note: This product is manufactured by lot after an order is received.

RATING

1. Coil data

1) Single side stable type

Nominal coil voltage	Pick-up voltage (at 20°C 68°F)	Drop-out voltage (at 20°C 68°F)	Nominal operating current [$\pm 10\%$] (at 20°C 68°F)	Coil resistance [$\pm 10\%$] (at 20°C 68°F)	Nominal operating power	Max. applied voltage (at 20°C 68°F)
5V DC	70%V or less of nominal voltage (Initial)	10%V or more of nominal voltage (Initial)	40 mA	125 Ω	200mW	130%V of nominal voltage
12V DC			16.6mA	720 Ω		
24V DC			8.3mA	2,880 Ω		

2) 2 coil latching type

Nominal coil voltage	Set voltage (at 20°C 68°F)	Reset voltage (at 20°C 68°F)	Nominal operating current [$\pm 10\%$] (at 20°C 68°F)		Coil resistance [$\pm 10\%$] (at 20°C 68°F)		Nominal operating power		Max. applied voltage (at 20°C 68°F)
			Set coil	Reset coil	Set coil	Reset coil	Set coil	Reset coil	
5V DC	70%V or less of nominal voltage (Initial)	70%V or less of nominal voltage (Initial)	40 mA	40 mA	125 Ω	125 Ω	200mW	200mW	130%V of nominal voltage
12V DC			16.6mA	16.6mA	720 Ω	720 Ω			
24V DC			8.3mA	8.3mA	2,880 Ω	2,880 Ω			

2. Specifications

Characteristics	Item	Specifications			
		1 Form A	1 Form A 1 Form B	2 Form A	
Contact	Arrangement				
	Contact resistance (Initial)	Max. 30 m Ω (By voltage drop 6 V DC 1A)			
	Contact material	AgSnO ₂ type			
Rating	Nominal switching capacity (resistive load)	10A 250V AC, 10A 30V DC	8A 250V AC, 8A 30V DC		
	Max. switching power (resistive load)	2,500VA, 300W	2,000VA, 240W		
	Max. switching voltage	250V AC, 30V DC	250V AC, 30V DC		
	Max. switching current	10A	8A		
	Min. switching capacity*1	100mA 5V DC			
Electrical characteristics	Insulation resistance (Initial)	Min. 1,000M Ω (at 500V DC) Measurement at same location as "Breakdown voltage" section.			
	Breakdown voltage (Initial)	Between open contacts	1,000 Vrms for 1 min. (Detection current: 10 mA)		
		Between contact sets	—	4,000 Vrms for 1 min. (Detection current: 10 mA)	
		Between contact and coil	5,000 Vrms for 1 min. (Detection current: 10 mA)		
	Surge breakdown voltage*2 (Between contact and coil)	12,000 V (Initial)			
	Operate time [Set time] (at 20°C 68°F)	Max. 10 ms [Max. 10 ms] (Nominal coil voltage applied to the coil, excluding contact bounce time.)			
Release time [Reset time] (at 20°C 68°F)		Max. 5 ms [Max. 10 ms] (Nominal coil voltage applied to the coil, excluding contact bounce time.) (without diode)			
	Mechanical characteristics	Shock resistance	Functional	Min. 196 m/s ² (Half-wave pulse of sine wave: 11 ms; detection time: 10 μ s.)	
Destructive			Min. 980 m/s ² (Half-wave pulse of sine wave: 6 ms.)		
Vibration resistance		Functional	10 to 55 Hz at double amplitude of 2 mm (Detection time: 10 μ s.)		
		Destructive	10 to 55 Hz at double amplitude of 3 mm		
Expected life	Mechanical	Min. 10 ⁷ (at 300 times/min.)			
Conditions	Conditions for operation, transport and storage*3 *4	Ambient temperature: -40°C to +70°C -40°F to +158°F; Humidity: 5 to 85% R.H. (Not freezing and condensing at low temperature)			
Unit weight		Approx. 7 g .25 oz			

Notes: *1. This value can change due to the switching frequency, environmental conditions, and desired reliability level, therefore it is recommended to check this with the actual load.

*2. Wave is standard shock voltage of $\pm 1.2 \times 50\mu$ s according to JEC-212-1981

*3. The upper limit of the ambient temperature is the maximum temperature that can satisfy the coil temperature rise value. Refer to Usage, transport and storage conditions in NOTES.

*4. Allowable temperature range with our package form: -40°C to +60°C -40°F to +140°F.

3. Electrical life

Condition: Resistive load, at 20 times/min.

Type	Switching capacity	No. of operations
1 Form A	10A 250V AC 10A 30V DC	min. 1 $\times 10^5$
1 Form A 1 Form B	8A 250V AC 8A 30V DC	min. 1 $\times 10^5$
2 Form A	8A 250V AC 8A 30V DC	min. 1 $\times 10^5$ min. 5 $\times 10^4$

REFERENCE DATA

1.-(1) Maximum switching power (1 Form A)

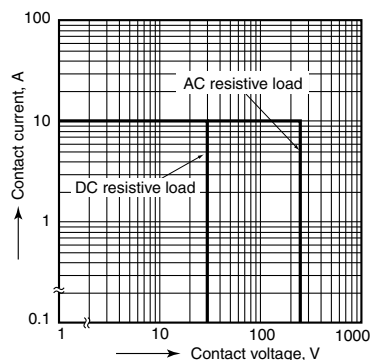

1.-(2) Maximum switching power (1 Form A 1 Form B, 2 Form A)

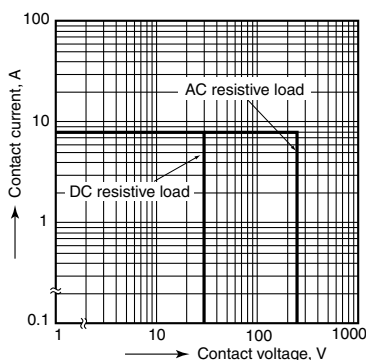

2.-(1) Life curve (1 Form A)

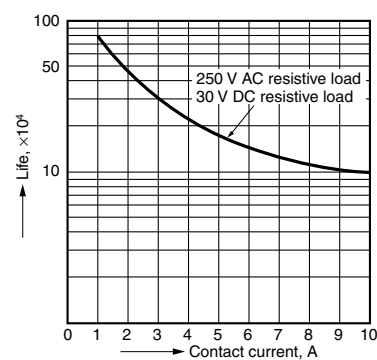

2.-(2) Life curve (1 Form A 1 Form B)

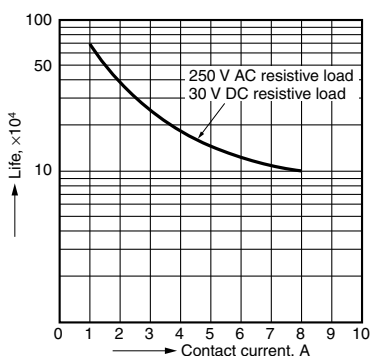

2.-(3) Life curve (2 Form A)

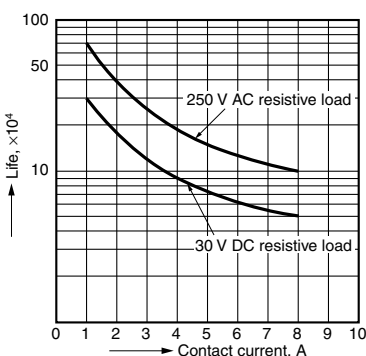

3.-(1) Coil temperature rise (1 Form A)

Tested sample: DE1a-5V
Quantity: n=6
Ambient temperature: 25°C to 70°C 77°F to 158°F

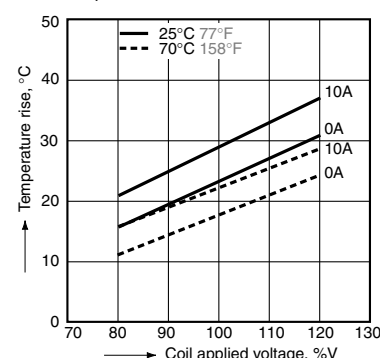

3.-(2) Coil temperature rise (1 Form A 1 Form B)

Tested sample: DE1a1b-5V
Quantity: n=6
Ambient temperature: 25°C to 70°C 77°F to 158°F

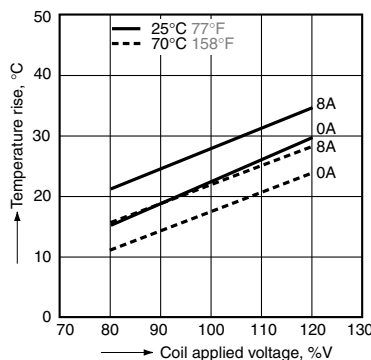

3.-(3) Coil temperature rise (2 Form A)

Tested sample: DE2a-5V
Quantity: n=6
Ambient temperature: 25°C to 70°C 77°F to 158°F

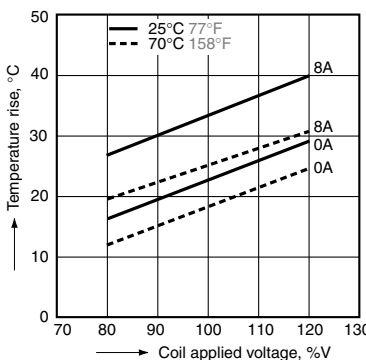

4.-(1) Operate/release time (1 Form A)

Tested sample: DE1a-5V
Quantity: n=5

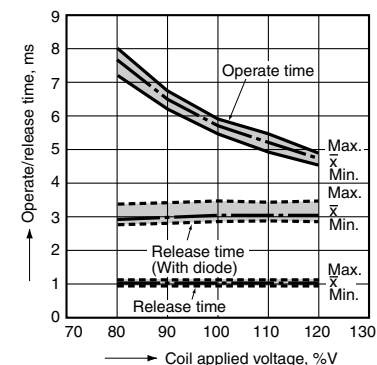

4.-(2) Operate/release time (1 Form A 1 Form B)

Tested sample: DE1a1b-5V, Quantity: n=5

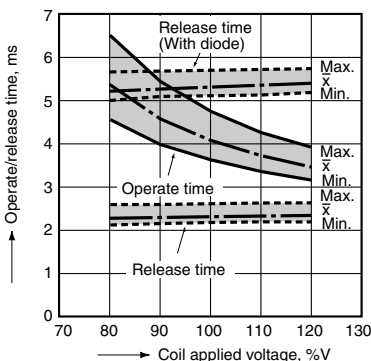

4.-(3) Operate/release time (2 Form A)

Tested sample: DE2a-5V, Quantity: n=5

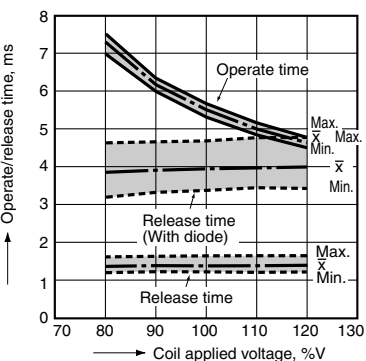

5.-(1) Ambient temperature characteristics (1 Form A)

Tested sample: DE1a-5V, Ambient temperature: -40°C to 80°C -40°F to 176°F, Quantity: n=6

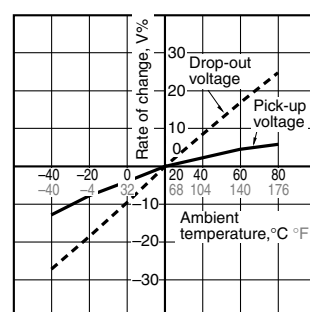

5.-(2) Ambient temperature characteristics
(1 Form A 1 Form B)

Tested sample: DE1a1b-5V, Ambient temperature:
-40°C to 80°C -40°F to 176°F, Quantity: n=6

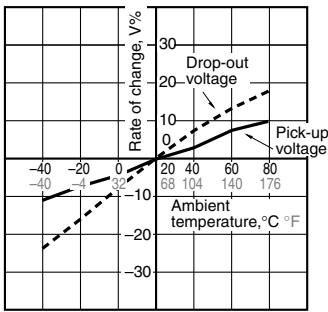

5.-(3) Ambient temperature characteristics
(2 Form A)

Tested sample: DE2a-5V, Ambient temperature:
-40°C to 80°C -40°F to 176°F, Quantity: n=6

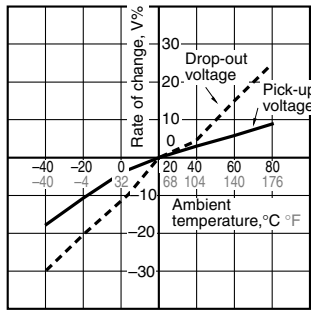

DIMENSIONS (mm inch)

The CAD data of the products with a **CAD Data** mark can be downloaded from: <http://industrial.panasonic.com/ac/e/>

CAD Data



External dimensions
Single side stable type

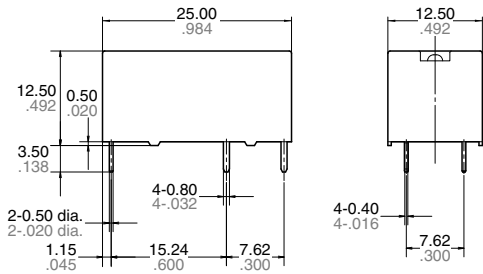

2 coil latching type

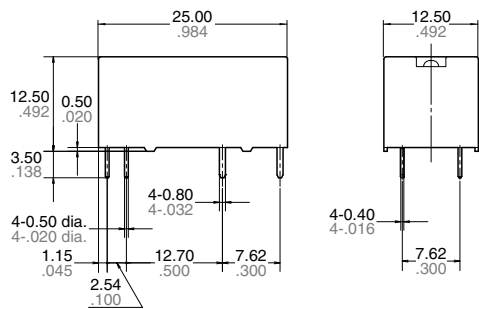

Tolerance: $\pm 0.3 \pm .012$

PC board pattern (Bottom view)
Single side stable type 2 coil latching type

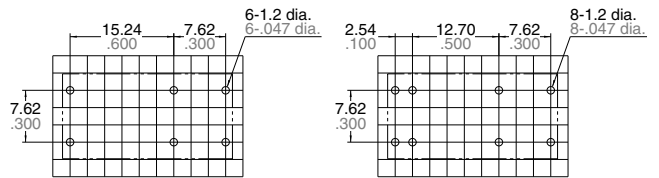

Tolerance : $\pm 0.1 \pm .004$

Schematic (Bottom view)

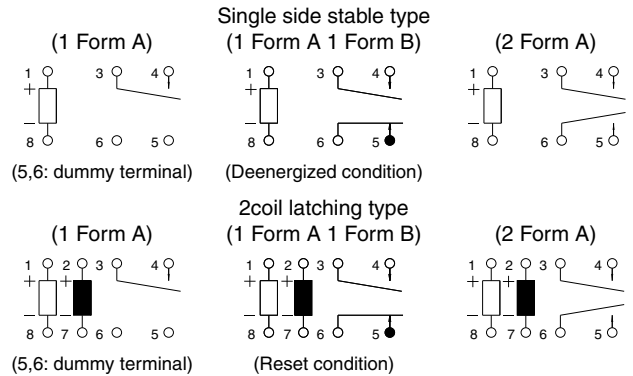

SAFETY STANDARDS

Types	UL/C-UL (Recognized)			VDE (Certified)			
	File No.	Contact rating	Cycles	File No.	Contact rating	Temperature	Cycles
1 Form A	E120782	8A 120V AC Lamp Load	3×10^4	115944	8A 250V AC ($\cos\phi=1.0$)	70°C 158°F	15×10^4
		12A 120V AC General use	3×10^4		16A 250V AC ($\cos\phi=1.0$)	70°C 158°F	6×10^3
		8A 277V AC General use	–		–	–	–
		10A 277V AC Ballast	–		–	–	–
		2A 480V AC Resistive	10^5		–	–	–
		1HP 277V AC	–		–	–	–
		6A 347V AC General use	3×10^4		–	–	–
		PILOT DUTY B300,R300	–		–	–	–
1 Form A 1 Form B	E120782	6A 120V AC Lamp Load	3×10^4	115944	8A 250V AC ($\cos\phi=1.0$)	70°C 158°F	15×10^4
		8.5A 120V AC General use	3×10^4		16A 250V AC ($\cos\phi=1.0$)	70°C 158°F	5×10^3
		6A 277V AC General use	3×10^4		–	–	–
		2A 480V AC Resistive	10^5		–	–	–
		0.7HP 277V AC	–		–	–	–
		4.5A 347V AC General use	3×10^4		–	–	–
		PILOT DUTY B300,R300	–		–	–	–
2 Form A	E120782	8A 120V AC Lamp Load	3×10^4	115944	8A 250V AC ($\cos\phi=1.0$)	70°C 158°F	–
		12A 120V AC General use	3×10^4		–	–	–
		8A 277V AC General use	–		–	–	–
		10A 277V AC Ballast	–		–	–	–
		2A 480V AC Resistive	10^5		–	–	–
		1HP 277V AC	–		–	–	–
		6A 347V AC General use	3×10^4		–	–	–
		PILOT DUTY B300,R300	–		–	–	–

* CSA standard: Certified by C-UL

EN/IEC VDE Certified INSULATION CHARACTERISTICS (IEC61810-1)

Item	Characteristics
Clearance/Creepage distance (IEC61810-1)	Min. 8.0/8.0mm
Category of protection (IEC61810-1)	RT III
Tracking resistance (IEC60112)	PTI 175
Insulation material group	III a
Over voltage category	III
Rated voltage	250V
Pollution degree	3
Type of insulation (Between contact and coil)	Reinforced insulation
Type of insulation (Between open contacts)	Micro disconnection

NOTES

1. For cautions for use, please read “GENERAL APPLICATION GUIDELINES”.

Please contact

Panasonic Corporation

Electromechanical Control Business Division

■ 1006, Oaza Kadoma, Kadoma-shi, Osaka 571-8506, Japan
industrial.panasonic.com/ac/e/

Panasonic[®]

©Panasonic Corporation 2016

X-ON Electronics

Largest Supplier of Electrical and Electronic Components

Click to view similar products for [General Purpose Relays](#) category:

Click to view products by [Panasonic](#) manufacturer:

Other Similar products are found below :

[PCN-105D3MH,000](#) [59641F200](#) [LY1SAC110120](#) [5X827E](#) [5X837F](#) [5X840F](#) [5X842F](#) [5X848E](#) [LY2N-AC120](#) [LY2S-AC220/240](#) [LY2-US-AC120](#) [LY3-US-AC120](#) [LY4F-UA-DC12](#) [LY4F-UA-DC24](#) [LY4F-US-AC120](#) [LY4F-US-AC240](#) [LY4F-US-DC24](#) [LY4F-VD-AC110](#) [LYQ20DC12](#) [M115C60](#) [M115N010](#) [M115N0150](#) [6031007G](#) [603-12D](#) [61211T0B4](#) [61212T400](#) [61222Q400](#) [61243B600](#) [61243C500](#) [61243Q400](#) [61311BOA2](#) [61311BOA6](#) [61311BOA8](#) [61311C0A2](#) [61311COA1](#) [61311COA6](#) [61311F0A2](#) [61311QOA1](#) [61311QOA4](#) [61311T0D6](#) [61311TOA6](#) [61311TOA7](#) [61311TOB3](#) [61311TOB4](#) [61311U0A6](#) [61312Q600](#) [61312T400](#) [61312T600](#) [61313U200](#) [61313U400](#)