



FEATURES

- 1. Compact with high capacity**
High capacity switching in a small package: 1 Form A, 10 A 250 V AC; 1 Form A 1 Form B and 2 Form A, 8 A 250 V AC.
- 2. High sensitivity: 200 mW nominal operating power**
- 3. High breakdown voltage**
Independent coil and the contact structure improves breakdown voltage.

Between contact and coil	Between open contacts
4,000 Vrms for 1 min. 10,000 V surge breakdown voltage	1,000 Vrms for 1 min. 1,500 V surge breakdown voltage

Conforms with FCC Part 68

- 4. Latching types available**
- 5. Sealed construction allows automatic washing.**
- 6. High insulation resistance**
Creepage distance and clearances between contact and coil: Min. 8 mm
DK2a-L2: 6.8 mm
DK1a1b-L2: 6.8 mm
- 7. Sockets are available**
- 8. Complies with safety standards**
Complies with Japan Electrical Appliance and Material Safety Law requirements for operating 200 V power supply circuits, and complies with UL, CSA, and TÜV safety standards.

TYPICAL APPLICATIONS

- 1. Switching power supply**
- 2. Power switching for various OA equipment**
- 3. Control or driving relays for industrial machines (robotics, numerical control machines, etc.)**
- 4. Output relays for programmable logic controllers, temperature controllers, timers and so on.**
- 5. Home appliances**

About Cd-free contacts

We have introduced Cadmium free type products to reduce Environmental Hazardous Substances. (The suffix "F" should be added to the part number)
(Note: The Suffix "F" is required only for 1 Form A contact type. The 2 Form A and 1 Form A 1 Form B contact type is originally Cadmium free, the suffix "F" is not required.)
Please replace parts containing Cadmium with Cadmium-free products and evaluate them with your actual application before use because the life of a relay depends on the contact material and load.

ORDERING INFORMATION

DK - - -

Contact arrangement

- 1a: 1 Form A
- 2a: 2 Form A
- 1a1b: 1 Form A 1 Form B

Operating function

- Nil: Single side stable
- L: 1 coil latching
- L2: 2 coil latching

Coil voltage (DC)

- 3, 5, 6, 9, 12, 24V

Contact material

- F: 1 Form A (AgSnO₂ type)
- Nil: 2 Form A, 1 Form A 1 Form B (Au-flashed AgNi type)

- Notes: 1. UL/CSA, TÜV approved type is standard.
2. VDE approved type is available.

TYPES

Contact arrangement	Nominal coil voltage	Single side stable	1 coil latching	2 coil latching
		Part No.	Part No.	Part No.
1 Form A	3V DC	DK1a-3V-F	DK1a-L-3V-F	DK1a-L2-3V-F
	5V DC	DK1a-5V-F	DK1a-L-5V-F	DK1a-L2-5V-F
	6V DC	DK1a-6V-F	DK1a-L-6V-F	DK1a-L2-6V-F
	9V DC	DK1a-9V-F	DK1a-L-9V-F	DK1a-L2-9V-F
	12V DC	DK1a-12V-F	DK1a-L-12V-F	DK1a-L2-12V-F
	24V DC	DK1a-24V-F	DK1a-L-24V-F	DK1a-L2-24V-F
1 Form A 1 Form B	3V DC	DK1a1b-3V	DK1a1b-L-3V	DK1a1b-L2-3V
	5V DC	DK1a1b-5V	DK1a1b-L-5V	DK1a1b-L2-5V
	6V DC	DK1a1b-6V	DK1a1b-L-6V	DK1a1b-L2-6V
	9V DC	DK1a1b-9V	DK1a1b-L-9V	DK1a1b-L2-9V
	12V DC	DK1a1b-12V	DK1a1b-L-12V	DK1a1b-L2-12V
	24V DC	DK1a1b-24V	DK1a1b-L-24V	DK1a1b-L2-24V
2 Form A	3V DC	DK2a-3V	DK2a-L-3V	DK2a-L2-3V
	5V DC	DK2a-5V	DK2a-L-5V	DK2a-L2-5V
	6V DC	DK2a-6V	DK2a-L-6V	DK2a-L2-6V
	9V DC	DK2a-9V	DK2a-L-9V	DK2a-L2-9V
	12V DC	DK2a-12V	DK2a-L-12V	DK2a-L2-12V
	24V DC	DK2a-24V	DK2a-L-24V	DK2a-L2-24V

Standard packing: Carton: 50 pcs.; Case: 500 pcs.

* For sockets, see page 8.

RATING

1. Coil data

1) Single side stable

Nominal coil voltage	Pick-up voltage (at 20°C 68°F)	Drop-out voltage (at 20°C 68°F)	Nominal operating current [±10%] (at 20°C 68°F)	Coil resistance [±10%] (at 20°C 68°F)	Nominal operating power	Max. applied voltage (at 20°C 68°F)
3V DC	70%V or less of nominal voltage (Initial)	10%V or more of nominal voltage (Initial)	66.6mA	45Ω	200mW	130%V of nominal voltage
5V DC			40mA	125Ω		
6V DC			33.3mA	180Ω		
9V DC			22.2mA	405Ω		
12V DC			16.6mA	720Ω		
24V DC			8.3mA	2,880Ω		

2) 1 coil latching

Nominal coil voltage	Set voltage (at 20°C 68°F)	Reset voltage (at 20°C 68°F)	Nominal operating current [±10%] (at 20°C 68°F)	Coil resistance [±10%] (at 20°C 68°F)	Nominal operating power	Max. applied voltage (at 20°C 68°F)
3V DC	70%V or less of nominal voltage (Initial)	10%V or more of nominal voltage (Initial)	33.3mA	90Ω	100mW	130%V of nominal voltage
5V DC			20mA	250Ω		
6V DC			16.6mA	360Ω		
9V DC			11.1mA	810Ω		
12V DC			8.3mA	1,440Ω		
24V DC			4.1mA	5,760Ω		

3) 2 coil latching

Nominal coil voltage	Set voltage (at 20°C 68°F)	Reset voltage (at 20°C 68°F)	Nominal operating current [±10%] (at 20°C 68°F)		Coil resistance [±10%] (at 20°C 68°F)		Nominal operating power		Max. applied voltage (at 20°C 68°F)
			Set coil	Reset coil	Set coil	Reset coil	Set coil	Reset coil	
3V DC	70%V or less of nominal voltage (Initial)	70%V or less of nominal voltage (Initial)	66.6mA	66.6mA	45Ω	45Ω	200mW	200mW	130%V of nominal voltage
5V DC			40mA	40mA	125Ω	125Ω			
6V DC			33.3mA	33.3mA	180Ω	180Ω			
9V DC			22.2mA	22.2mA	405Ω	405Ω			
12V DC			16.6mA	16.6mA	720Ω	720Ω			
24V DC			8.3mA	8.3mA	2,880Ω	2,880Ω			

2. Specifications

Characteristics	Item	Specifications		
		1 Form A	1 Form A 1 Form B	2 Form A
Contact	Arrangement	1 Form A	1 Form A 1 Form B	2 Form A
	Contact resistance (Initial)	Max. 30 mΩ (By voltage drop 6 V DC 1A)		
	Contact material	Au-flashed AgSnO ₂ type	Au-flashed AgNi type	
Rating	Nominal switching capacity (resistive load)	10 A 250 V AC, 10 A 30 V DC	8 A 250 V AC, 8 A 30 V DC	8 A 250 V AC, 8 A 30 V DC
	Max. switching power (resistive load)	2,500VA, 300 W	2,000 VA, 240 W	2,000 VA, 240 W
	Max. switching voltage	250 V AC, 125 V DC	250 V AC, 125 V DC	250 V AC, 125 V DC
	Max. switching current	10 A	8 A	8 A
	Nominal operating power	200 mW		
	Min. switching capacity (Reference value)*1	10m A 5 V DC		
Electrical characteristics	Insulation resistance (Initial)	Min. 1,000MΩ (at 500V DC) Measurement at same location as "Breakdown voltage" section.		
	Breakdown voltage (Initial)	Between open contacts	1,000 Vrms for 1min. (Detection current: 10mA.)	
		Between contact and coil	4,000 Vrms for 1min. (Detection current: 10mA.)	
	Surge breakdown voltage*2 (Initial)	between contacts and coil	10,000 V	
	Temperature rise (coil) (at 65°C 149°F)	Max. 40°C (By resistive method, nominal voltage applied to the coil; max. switching current)		
	Operate time [Set time] (at 20°C 68°F)	Max. 10 ms (Approx. 5 ms) [10 ms (Approx. 5 ms)] (Nominal coil voltage applied to the coil, excluding contact bounce time.)		
Release time [Reset time] (at 20°C 68°F)	Max. 8 ms (Approx. 3 ms) [10 ms (Approx. 3 ms)] (Nominal coil voltage applied to the coil, excluding contact bounce time.) (without diode)			
Mechanical characteristics	Shock resistance	Functional	Min. 98 m/s ² (Half-wave pulse of sine wave: 11 ms; detection time: 10μs.)	
		Destructive	Min. 980 m/s ² (Half-wave pulse of sine wave: 6 ms.)	
	Vibration resistance	Functional	10 to 55 Hz at double amplitude of 1.5 mm (Detection time: 10μs.)	
		Destructive	10 to 55 Hz at double amplitude of 3 mm	
Expected life	Mechanical	Min. 5×10 ⁷ (at 300 times/min.)		
	Electrical	Min. 10 ⁵ (resistive load, at 20 times/min., at rated capacity)		
Conditions	Conditions for operation, transport and storage*3	Ambient temperature: -40°C to +65°C -40°F to +149°F, Humidity: 5 to 85% R.H. (Not freezing and condensing at low temperature)		
	Max. operating speed (at rated load)	20 times/min.		
Unit weight		Approx. 5 g .18 oz	Approx. 6 g .21 oz	Approx. 6 g .21 oz

Notes:

*1. This value can change due to the switching frequency, environmental conditions, and desired reliability level, therefore it is recommended to check this with the actual load.

*2. Wave is standard shock voltage of ±1.2×50μs according to JEC-212-1981

*3. The upper limit of the ambient temperature is the maximum temperature that can satisfy the coil temperature rise value. Refer to "6. Usage, Storage and Transport Conditions" in [AMBIENT ENVIRONMENT section in Relay Technical Information](#).

REFERENCE DATA

1-(1). Maximum operating power (1 Form A)

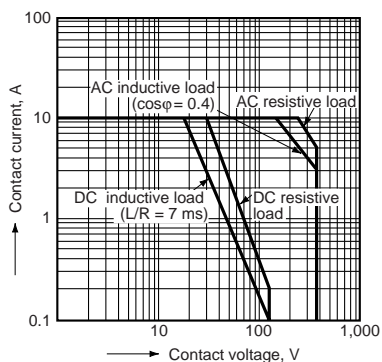

1-(2). Maximum operating power (1 Form A 1 Form B, 2 Form A)

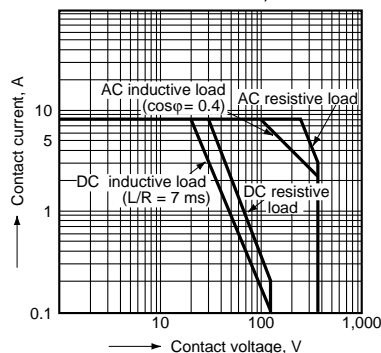

2-(1). Life curve (1 Form A)

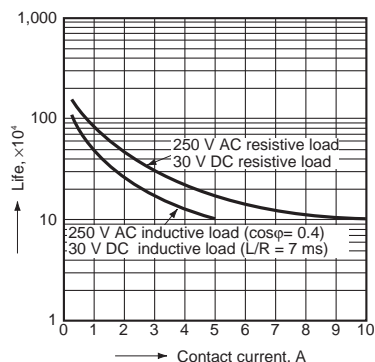

2-(2). Life curve (1 Form A 1 Form B, 2 Form A)

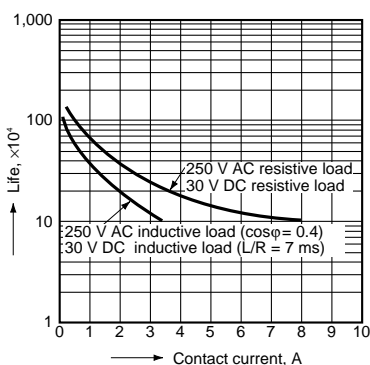

3-(1). Operate/Release time (1 Form A)
Tested sample: DK1a-24V, 5 pcs.

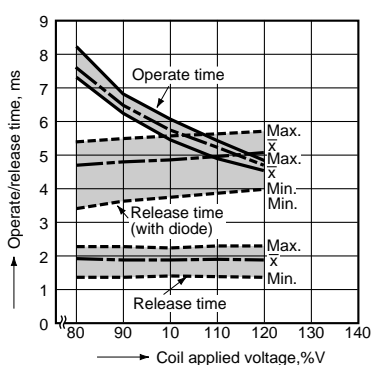

3-(2). Operate/Release time (1 Form A 1 Form B, 2 Form A)
Tested sample: DK1a1b-12V, 5 pcs.

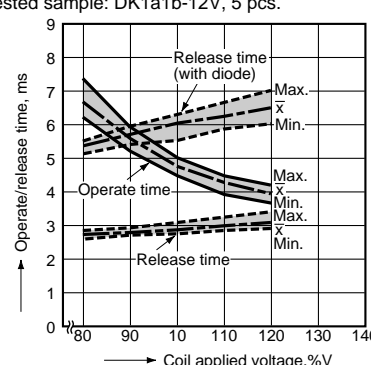

4-(1). Coil temperature rise (1 Form A)
Tested sample: DK1a-12V, 5 pcs.
Ambient temperature: 30°C 86°F

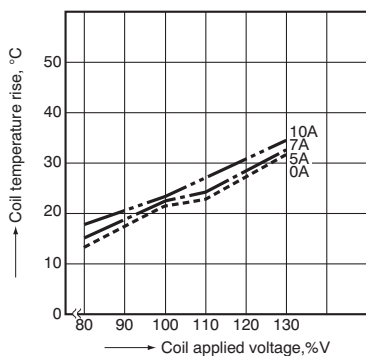

4-(2). Coil temperature rise (1 Form A 1 Form B, 2 Form A)
Tested sample: DK1a1b-12V, 5 pcs.
Ambient temperature: 20°C 68°F

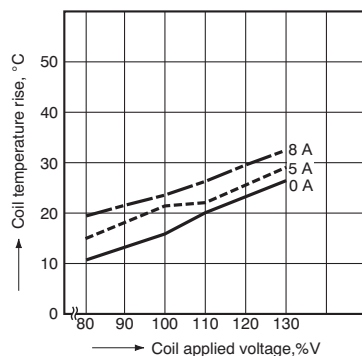

5-(1). Ambient temperature characteristics (1 Form A)
Tested sample: DK1a-24V, 6 pcs
Ambient temperature: -40°C to +80°C
-40°F to +176°F

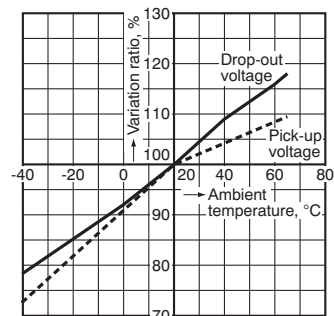

5-(2). Ambient temperature characteristics (1 Form A 1 Form B, 2 Form A)

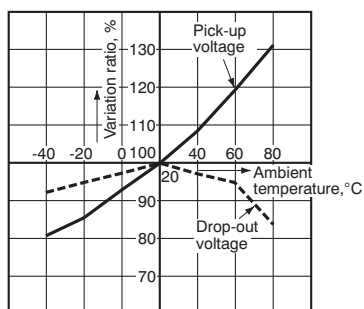

1. 1 Form A type

[CAD Data](#)



External dimensions

Single side stable type

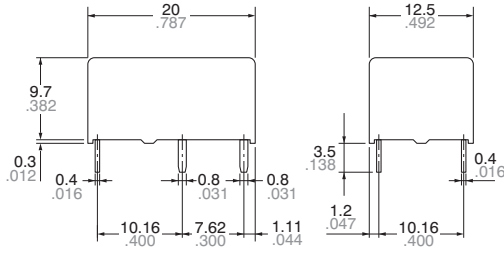

2 coil latching type

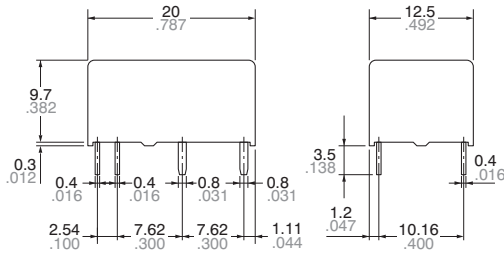

General tolerance: $\pm 0.3 \pm 0.012$

PC board pattern (Bottom view)

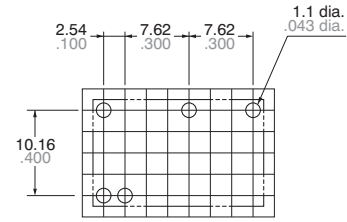
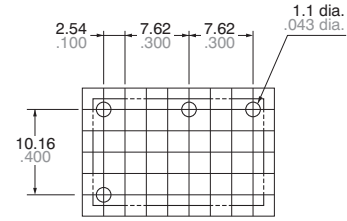

Tolerance: $\pm 0.1 \pm 0.004$

Schematic (Bottom view)

Single side stable

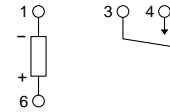

(Deenergized condition)

1 coil latching

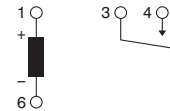

(Reset condition)

2 coil latching

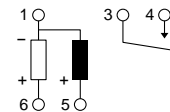

(Reset condition)

Since this is a polarized relay, the connection to the coil should be done according to the above schematic.

2. 1 Form A 1 Form B type, 2 Form A type

CAD Data

External dimensions

PC board pattern (Bottom view)



Single side stable type

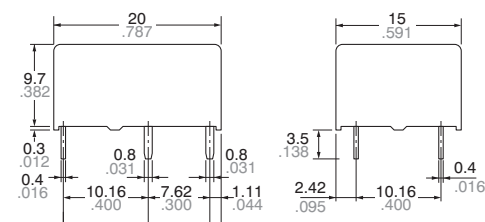

2 coil latching type

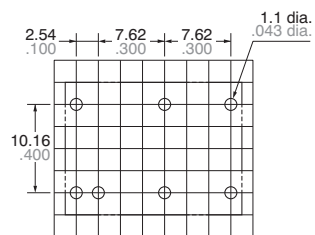
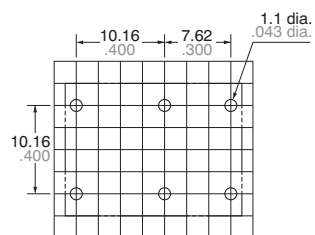
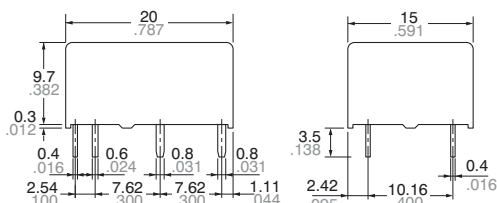

General tolerance: $\pm 0.3 \pm 0.12$

Tolerance: $\pm 0.1 \pm 0.04$

Schematic (Bottom view)

<1 Form A 1 Form B type>
Single side stable

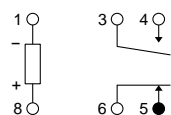

(Deenergized condition)

1 coil latching

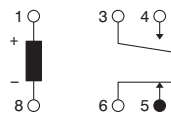

(Reset condition)

2 coil latching

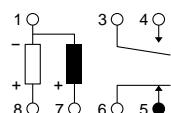

(Reset condition)

Schematic (Bottom view)

<2 Form A>
Single side stable

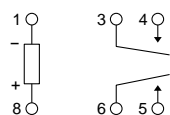

(Deenergized condition)

1 coil latching

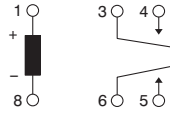

(Reset condition)

2 coil latching

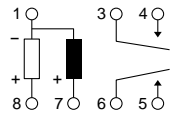

(Reset condition)

Since this is a polarized relay, the connection to the coil should be done according to the above schematic.

SAFETY STANDARDS

Item	UL/C-UL (Recognized)		CSA (Certified)		VDE (Certified)		TÜV (Certified)	
	File No.	Contact rating	File No.	Contact rating	File No.	Contact rating	File No.	Rating
1 Form A	E43028	10A 250V AC 1/3HP 125, 250V AC 10A 30V DC	LR26550 etc.	10A 250V AC 1/3HP 125, 250V AC 10A 30V DC	006099UG	AC 250V 10A (cos φ=1.0) AC 250V 5A (cos φ=0.4) DC 30V 10A (0ms)	8705 1645 520	10A 250V AC (cos φ=1.0) 5A 250V AC (cos φ=0.4) 10A 30V DC
1 Form A 1 Form B, 2 Form A	E43028	8A 250V AC 1/4HP 125, 250V AC 8A 30V DC	LR26550 etc.	8A 250V AC 1/4HP 125, 250V AC 8A 30V DC	006099UG	1 Form A 1 Form B: AC 250V 8A (cos φ=1.0) 2 Form A: AC 250V 8A (cos φ=1.0) AC 250V 4A (cos φ=0.4)	8705 1645 520 (1 Form A 1 Form B) 9407 13461 097 (2 Form A)	8A 250V AC (cos φ=1.0) 4A 250V AC (cos φ=0.4) 8A 30V DC

NOTES

1. Soldering should be done under the following conditions:

250°C 482°F within 10s

300°C 572°F within 5s

350°C 662°F within 3s

Soldering depth: 2/3 terminal pitch

2. External magnetic field

Since DK relays are highly sensitive polarized relays, their characteristics will be affected by a strong external magnetic field. Avoid using the relay under that condition.

3. When using, please be aware that the a contact and b contact sides of 1 Form A and 1 Form B types may go on simultaneously at operate time and release time.

For Cautions for Use, see [Relay Technical Information](#).



FEATURES

DK relay sockets that can be used also for DY relay.

TYPES

Type		Part No.
1 Form A	Single side stable	DK1a-PS
	2 coil latching	DK1a-PSL2
1 Form A 1 Form B, 2 Form A*	Single side stable	DK2a-PS
	2 coil latching	DK2a-PSL2

Standard packing: Carton: 50 pcs.; Case: 500 pcs
Note: * 2 Form A type is DK relays only.

RELAY COMPATIBILITY

Relay	Socket	1 Form A		1 Form A 1 Form B, 2 Form A	
		Single side stable type	2 coil latching type	Single side stable type	2 coil latching type
1 Form A	Single side stable type	●	●	—	—
	2 coil latching type	—	●	—	—
1 Form A 1 Form B 2 Form A	Single side stable type	—	—	●	●
	2 coil latching type	—	—	—	●

SPECIFICATIONS

Item	Specifications
Breakdown voltage	4,000 Vrms (Detection current: 10 mA) (Except the portion between coil terminals)
Insulation resistance	Min. 1,000 mΩ (at 500 V DC)
Heat resistance	150°C (for 1 hour)
Max. continuous current	10 A (DK1a-PS, DK1a-PSL2), 8 A (DK2a-PS, DK2a-PSL2)

DIMENSIONS (mm inch)

External dimensions

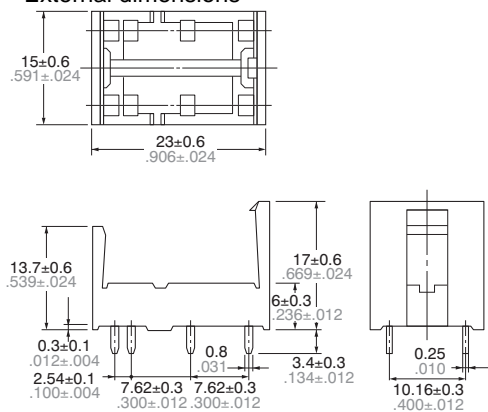

PC board pattern (Bottom view)

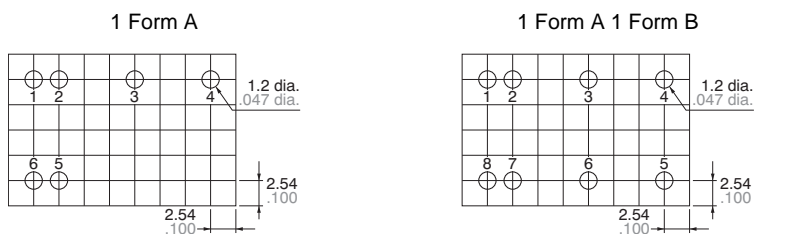

The above shows 2 coil latching type. No.2 and 5 terminal are eliminated on single side stable type.

The above shows 2 coil latching type. No.2 and 7 terminal are eliminated on single side stable type.

FIXING AND REMOVAL METHOD

1. Match the direction of relay and socket.

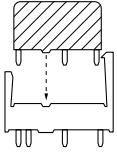

2. Both ends of the relay are to be secured firmly so that the socket hooks on the top surface of the relay.

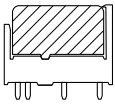

GOOD

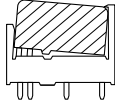

NO GOOD

3. Remove the relay, applying force in the direction shown below.

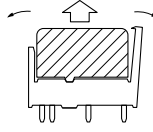

4. In case there is not enough space to grasp the relay with fingers, use screwdrivers in the way shown in the illustration.

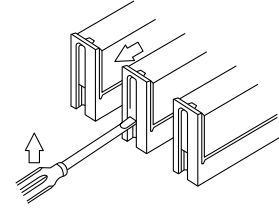

Notes: 1. Exercise care when removing relays. If greater than necessary force is applied at the socket hooks, deformation may alter the dimensions so that the hook will no longer catch, and other damage may also occur.
2. It is hazardous to use IC chip sockets.

X-ON Electronics

Largest Supplier of Electrical and Electronic Components

Click to view similar products for [General Purpose Relays](#) category:

Click to view products by [Panasonic](#) manufacturer:

Other Similar products are found below :

[APF30318](#) [JVN1AF-4.5V-F](#) [PCN-105D3MHZ](#) [5JO-10000S-SIL](#) [5JO-1000CD-SIL](#) [5JO-400CD-SIL](#) [LY2S-AC220/240](#) [LYQ20DC12](#)
[6031007G](#) [6131406HQ](#) [6-1393099-3](#) [6-1393099-8](#) [6-1393122-4](#) [6-1393123-2](#) [6-1393767-1](#) [6-1393843-7](#) [6-1415012-1](#) [6-1419102-2](#) [6-](#)
[1423698-4](#) [6-1608051-6](#) [6-1608067-0](#) [6-1616170-6](#) [6-1616248-2](#) [6-1616282-3](#) [6-1616348-2](#) [6-1616350-1](#) [6-1616350-8](#) [6-1616358-7](#) [6-](#)
[1616359-9](#) [6-1616360-9](#) [6-1616931-6](#) [6-1617039-1](#) [6-1617052-1](#) [6-1617090-2](#) [6-1617090-5](#) [6-1617347-5](#) [6-1617353-3](#) [6-1617801-8](#) [6-](#)
[1617802-2](#) [6-1618107-9](#) [6-1618248-4](#) [M83536/1-027M](#) [CX-4014](#) [MAHC-5494](#) [MAVCD-5419-6](#) [703XCX-120A](#) [7-1393100-5](#) [7-1393111-7](#)
[7-1393144-5](#) [7-1393767-8](#)