

NEW

IO-Link Compatible, High-level Self-diagnosis Self-Monitoring Sensor

Digital Fiber Sensor

FX-550L SERIES

Dual Display Digital Pressure Sensor

DP-100L SERIES

CMOS Type Micro Laser Distance Sensor

HG-C1000L SERIES



FX-550L SERIES



DP-100L SERIES



HG-C1000L SERIES

Capable of diagnosing own state
and reporting to the host device

Reduction of the data analysis burden -

IO-Link compatible

Collecting sensor level data

Field data collected and accumulated for “preventive maintenance” and “operation monitoring”. An analysis of such field data requires high-level know-how and time, causing a burden to people responsible for the production site management.

The **Self-Monitoring Sensor** manufactured by Panasonic is capable of reporting sensor data and its own state to the host device through the I/O Link master.

With the Self-Monitoring Sensor, you can immediately judge the state of the sensor and easily identify the cause of failure. Thus, this sensor contributes to the **reduction of the burden experienced by the client in collecting and analyzing data.**

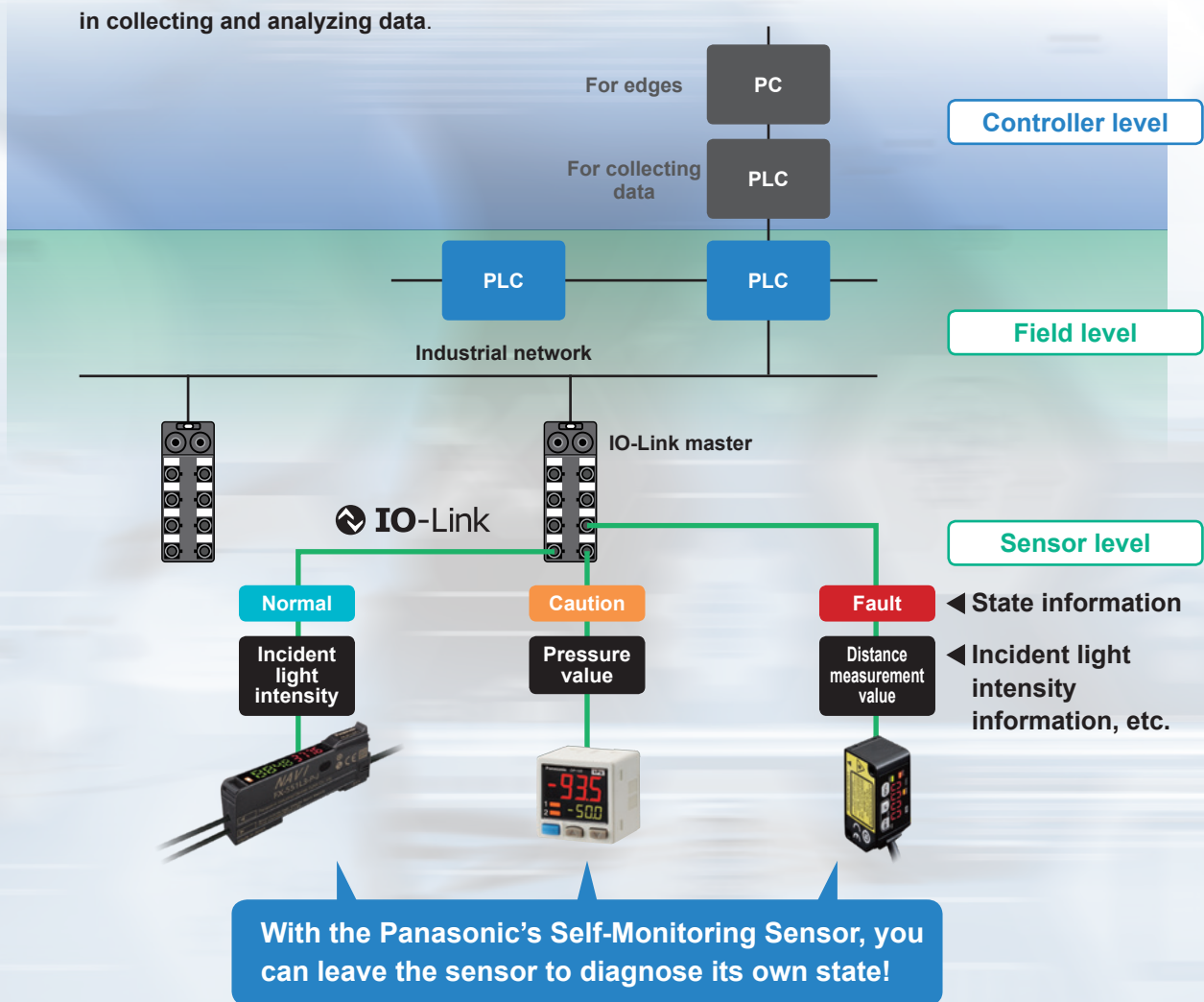

What is “IO-Link”?



IO-Link is an open communication technology according to IEC 61131-9 for the 1:1 bidirectional communication between the IO-Link device (sensor or actuator) and the IO-Link master.

Self-Monitoring Sensor

Digital Fiber Sensor

FX-550L SERIES

Dual Display Digital Pressure Sensor

DP-100L SERIES

CMOS Type Micro Laser Distance Sensor

HG-C1000L SERIES

one small step towards IoT.

Incorporated high-level self-diagnosis function

With the Panasonic's Self-Monitoring Sensor, you can get high-level solutions!

The introduction of IoT requires collection of the incident light intensity data and presents the following problems.

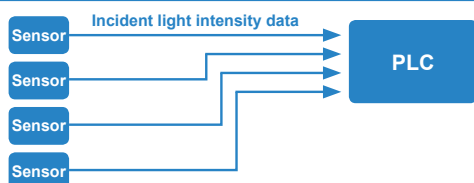

Previously only ON/OFF data was required. But, due to an addition of the incident light intensity data, the PLC processing burden has increased.

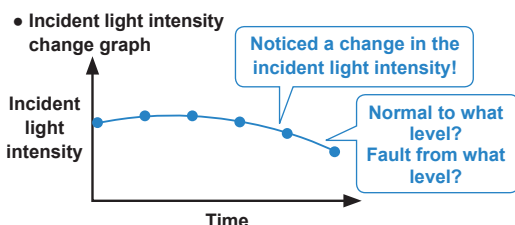

We noticed a change in the incident light intensity. However, because there is no judgment criteria, we cannot tell whether the incident light status is normal or not.

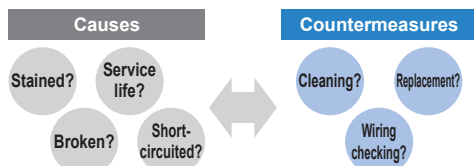

Unless we identify the cause of changes in the incident light intensity, we cannot optimize countermeasures targeting the sensors.

Problems are solved by the high-level self-diagnosis.

		Judgement of the state	
Normal	Notification	Operation is normal.	
		Check the settings. Detected state is faulty.	* Recover to the normal state through checking installation and settings. Reduction in the incident light intensity.
Caution		Getting close to the end of service life. Reached the state where the device should be replaced.	* Limitation in the writing frequency into the memory or in the operation hours, etc.
Fault		Short-circuited or broken. Reached the state where it is impossible to control as a device.	* Short-circuited output, damaged EEPROM, etc.

Easy use of IoT

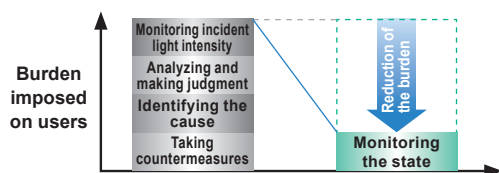

“Predictive maintenance” can be easily achieved through monitoring the state of the Self-Monitoring Sensor.

IoT Examples at FA Sites

Before the introduction of Self-Monitoring Sensors

Preventive maintenance

- We want to avoid production line stoppage that might occur due to unexpected sensor failure.

Line stoppage hours × (manufacturing unit cost / hour) = Loss

- We want to minimize the production line down time to almost zero.

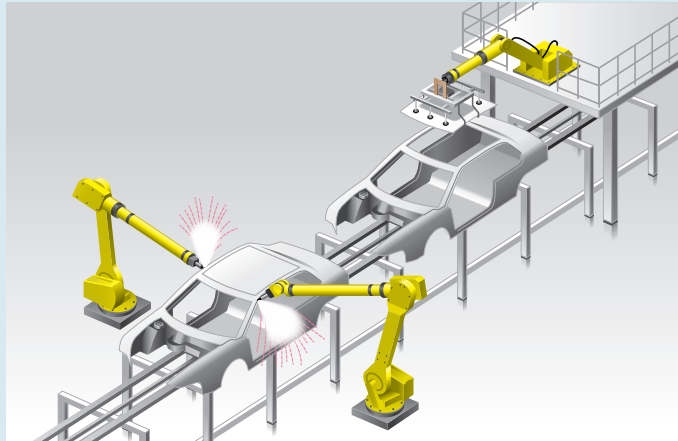

Problems

- ◆ The amount of data to be collected is large and this may lower the PLC processing capacity.
- ◆ The burden of data analysis is large. ◆ Resetting the replaced sensors is troublesome.

Remote controlling and batch settings

- We want to place sensors close to sensing points as much as possible. However, it is often difficult to make settings, particularly when there are many sensors to install.
- We want to send predetermined parameter values in a batch file for a repeater, etc.
- We want to confirm that required sensors are properly connected at the startup of the system.

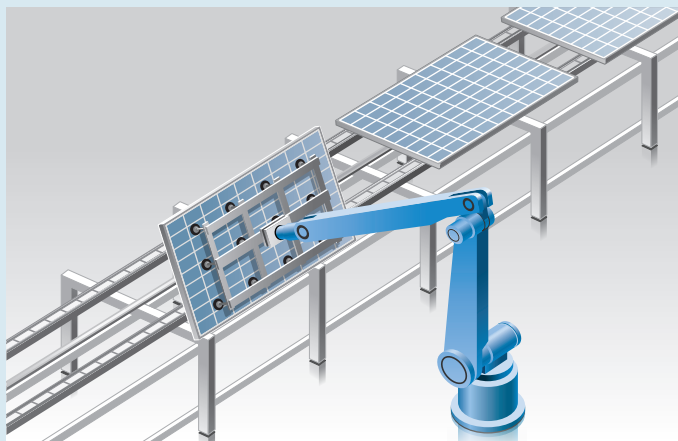

Problems

- ◆ It takes time to set sensors.
- ◆ We want to avoid mistakes in setting sensors or wiring.

Self-Monitoring Sensor

Digital Fiber Sensor

FX-550L SERIES

Dual Display Digital Pressure Sensor

DP-100L SERIES

CMOS Type Micro Laser Distance Sensor

HG-C1000L SERIES

After the introduction of Self-Monitoring Sensors

From preventive maintenance
to predictive maintenance

Leave the sensor diagnosis to the sensor itself.

- All you need to do is to monitor the sensor state.
- PLC can be used exclusively for controlling devices.
- Possible to check detail information at a desired timing.

Leave the resetting for replaced sensors to the higher-level master

- Automatically written from the connected master.
- Possible not only to save time but also to prevent human errors.

Fully utilize the advantages of the IO-Link output.

- Possible to read or write set values through external interface.
- Possible to set multiple sensors in a batch process.
- Possible to save the set parameters in an external medium.
- Possible to recognize and discriminate individual information.

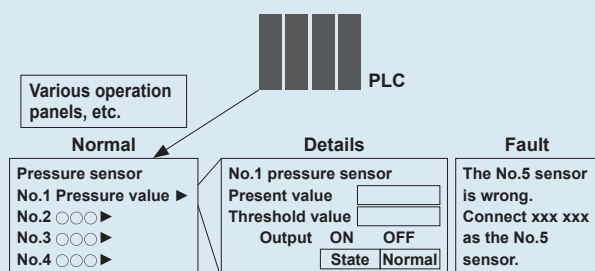

What is “IO-Link”?



FAST & SMART

Depending on the I/O-Link device, communication is performed at one of the three baud rates: COM1 (= 4.8 kbps), COM2 (= 38.4 kbps), and COM3 (= 230.4 kbps). The I/O-Link master reads the baud rate of the connected device and sets it automatically.

Various parameters set in the device are automatically saved in the IO-Link master. When the device is replaced with a new one of the same model, the saved parameters are automatically written into the new device.

EASY & GLOBAL

Each IO-Link device has an IODD (IO Device Description) file that contains individual information such as the manufacturer's name and model name. Since the IODD file is globally common, by reading the IODD file, the IO-Link device can be easily set and can be used regardless of the manufacturer of the IO-Link master.

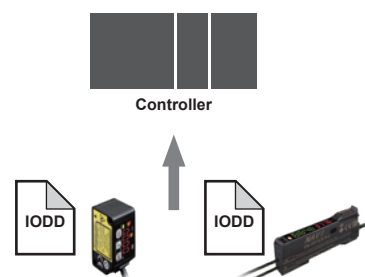

* An IODD file of the Self-Monitoring Sensor can be downloaded from our website.

High-level Self-diagnosis by the Sensor Itself

Self-Monitoring Sensor



Emission power: 3 times the conventional ratio, Sensing range: 1.6 times max.!



Digital Fiber Sensor

FX-550L SERIES

Largely improved stability and ease of use due to higher emission power and broader utility! This digital fiber sensor realizes longer sensing range than expected even with thin fibers.

Typical fiber combination examples

Fibers in combination with FX-550L series		Sensing range	
Type	Model No.	STD mode	
Thru-beam type	Thin diameter M3 tough fiber	FT-31	480 mm 18.898 in
	Standard M4 tough fiber	FT-42	1,470 mm 57.874 in
Reflective type	Thin diameter M4 tough fiber	FD-41	200 mm 7.874 in
	Standard M6 tough fiber	FD-61	620 mm 24.409 in

FX-550L series event functions			
Fault level	Sensor display	State	
Normal	Displays incident light intensity.	Unstable light incidence or unstable light interruption	Notification information
Caution	Displays incident light intensity.	Operation hours exceeded	
Caution	Displays incident light intensity.	Nonvolatile memory writing frequency exceeded	
Fault	Er11	Short-circuited output	
Fault	Er01	Nonvolatile memory error	
Fault	Er02	Nonvolatile memory writing error	

For details on the FX-550L series, refer to page 8 onwards.

Dual 3-color display makes operation easier!



Dual Display Digital Pressure Sensor

DP-100L SERIES

Displays the current value and the threshold value at the same time and allows the threshold value to be set directly. Operations can be performed smoothly without switching the screen mode.

Type and rated pressure range

Type	Model No.	Rated pressure range
For low pressure	DP-101ZL3-M-P(-C)	-100.0 to +100.0 kPa
For high pressure	DP-102ZL3-M-P(-C)	-0.100 to +1.000 MPa

DP-100L series event functions			
Fault level	Sensor display	State	
Normal	E-3	Application of pressure during zero-adjustment	Notification information
Normal	E-4	Zero-adjustment outside the rated pressure	
Normal	1010	The applied pressure exceeds the upper limit or Pressure element error	
Normal	-1010	The applied pressure exceeds the lower limit	
Caution	Displays pressure value.	Operation hours exceeded	
Caution	Displays pressure value.	Nonvolatile memory writing frequency exceeded	
Fault	E-1	Short-circuited output	

For details on the DP-100L series, refer to page 12 onwards.

Self-Monitoring Sensor

Digital Fiber Sensor

FX-550L SERIES

Dual Display Digital Pressure Sensor

DP-100L SERIES

CMOS Type Micro Laser Distance Sensor

HG-C1000L SERIES

CMOS laser sensor that provides stable detection with a repeatability of 10 μm **0.394 mil*** !

* HG-C1030L3-P(-J)



FDA
Conforming to
FDA regulations



CMOS Type Micro Laser Distance Sensor

HG-C1000L SERIES

The micro laser distance sensor contains a high-precision CMOS image sensor built into its compact body, and provides overwhelmingly stable detection.

Type and measurement range

Type	Model No.	Measurement center distance and measurement range
Measurement center 30 mm 1.181 in type	HG-C1030L3-P(-J)	30 \pm 5 mm 1.181 \pm 0.197 in
Measurement center 50 mm 1.969 in type	HG-C1050L3-P(-J)	50 \pm 15 mm 1.969 \pm 0.591 in
Measurement center 100 mm 3.937 in type	HG-C1100L3-P(-J)	100 \pm 35 mm 3.937 \pm 1.378 in
Measurement center 200 mm 7.874 in type	HG-C1200L3-P(-J)	200 \pm 80 mm 7.874 \pm 3.150 in
Measurement center 400 mm 15.748 in type	HG-C1400L3-P(-J)	400 \pm 200 mm 15.748 \pm 7.874 in

HG-C1000L series event functions

Fault level	Sensor display	State	
Normal	Er31	Zero setting not possible	Notification information
Normal	Er41	Teaching not possible	
Normal	----	Measurement error (insufficient light intensity)	
Normal	----	Measurement error (outside usage range, near point)	
Normal	----	Measurement error (outside usage range, far point)	
Normal	Displays measurement value.	Incident light intensity decreased	
Caution	Displays measurement value.	Operation hours exceeded	
Caution	Displays measurement value.	Nonvolatile memory writing frequency exceeded	
Fault	Er11	Short-circuited output	
Fault	Er90	System error	
	Er91		
	Er92		
	Er93		
Fault	Er01	Nonvolatile memory writing error	
Fault	Er01	Nonvolatile memory CRC error	
Fault	Er21	Damage in the light-emitting circuit	

For details on the HG-C1000L series, refer to page 20 onwards.

Features of the Self-Monitoring Sensor

• Performs high-level self-diagnosis, classifies the sensor state in three levels: Normal, Caution, and Fault, and notifies its own state as notification information.

• Uses IO-Link as a communication method.

• Possible to manage individual sensor information. It is possible to prevent trouble such as wrong sensor connection and to shorten the time required to recover from production line trouble.

• The baud rate is 230.4 kbps (COM3) for all series.

• Collection of digital data enables operation monitoring, remote controlling, and batch setting.

• Setting parameters of the sensors are stored in the IO-Link master, which enables automatic writing from the master when devices are replaced.

• Cables are available in two types: Discrete wire type and M12 connector type. The M12 connector type supports the Smartclick and can be connected to the IO-Link master by just turning by 1/8 turn.

*When connecting to a connector other than the Smartclick type, it can be connected using an ordinary screw tightening method.

• 4-core cable specifications that separately output the control output (DO) and the communication output (C/Q).

• Same size and mounting procedures as for the existing series models.

Series name	Digital Fiber Sensor FX-550L series	Dual Display Digital Pressure Sensor DP-100L series	CMOS Type Micro Laser Distance Sensor HG-C1000L series
Type			
Discrete wire type	FX-551L3-P-C2	DP-101ZL3-M-P DP-102ZL3-M-P	HG-C1030L3-P
			HG-C1050L3-P
			HG-C1100L3-P
			HG-C1200L3-P
			HG-C1400L3-P
M12 connector type	FX-551L3-P-J	DP-101ZL3-M-P-C DP-102ZL3-M-P-C	HG-C1030L3-P-J
			HG-C1050L3-P-J
			HG-C1100L3-P-J
			HG-C1200L3-P-J
			HG-C1400L3-P-J
Supports Smartclick			

* Smartclick is a registered trademark of OMRON Corporation.

* An IODD file of the Self-Monitoring Sensor can be downloaded from our website.

ORDER GUIDE

FX-550L SERIES

Amplifiers

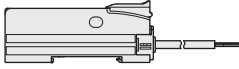
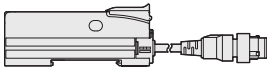
Type	Appearance	Model No.	Emitting element	Control output
Discrete wire type		FX-551L3-P-C2	Red LED	PNP open-collector transistor
M12 connector type	 Supports Smartclick (Note)	FX-551L3-P-J		

Note: Smartclick is a registered trademark of OMRON Corporation.

End plates End plates are not supplied with the amplifier. Please order them separately when the amplifiers are mounted in cascade.

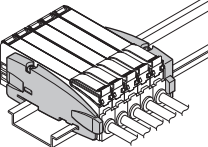
Appearance	Model No.	Description
	MS-DIN-E	When amplifiers are mounted in cascade, or when an amplifier moves depending on the way it is installed on a DIN rail, these end plates clamp amplifiers into place on both sides. Make sure to use end plates when cascading multiple amplifiers together. 2 pcs. per set

OPTIONS

Designation	Model No.	Description
Amplifier mounting bracket	MS-DIN-2	Mounting bracket for amplifier

Amplifier mounting bracket

• **MS-DIN-2**

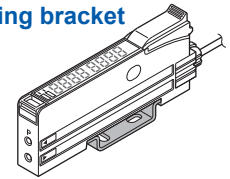

Recommended extension cables for M12 connector type

Manufactured by OMRON Corporation







Extension cable with connectors on both ends XS5W series 

* Smartclick is a registered trademark of OMRON Corporation. Contact the manufacturer for details of the recommended products.

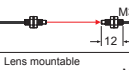
Tough : Refer to a fiber which possesses both unbreakable (bending radius: R10 mm **R0.394 in.**, reciprocating bending: 180°) and more flexible (bending radius: R4 mm **R0.157 in** or less) features.
Bending durability : Refer to a fiber which possesses unbreakable bending-resistant feature (bending radius: R10 mm **R0.394 in.**, reciprocating bending: 180°).

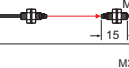
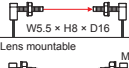
LIST OF FIBERS

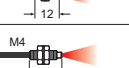
* Both **FX-551L3-P-C2** and **FX-551L3-P-J** can be connected to the same fibers as for the digital fiber sensor **FX-550** series and provide the same sensing range. However, the FAST mode is not available.

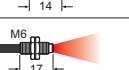
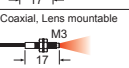
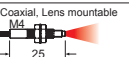
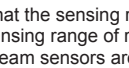
Type	Shape of fiber head (mm)	Model No.	Bending radius (mm)	Fiber cable length Free-cut	Sensing range (mm in) (Note 1) (Note 2)		Beam axis dia. (mm)	Beam axis position / Inclination of beam axis	Protection	Ambient temp.
					STD	HYPR				
Thru-beam (Note 3)	Threaded	M3 	Tough Bending durability R2		STD 480 18.898	1,000 39.370 700 27.559	∅0.5	150 μm / ±2°	IP67	-55 to +80 °C -67 to +176 °F
		M4 	Tough Bending durability R4		STD 1,470 57.874 HYPR 3,600 141.732 (Note 4)	2,900 114.173 2,100 82.677	∅1			
	Square head	M3 	Tough Bending durability R2		STD 510 20.079 HYPR 1,670 65.748	1,120 44.094 700 27.559	∅0.5	—		
		M4 	Tough Bending durability R4		STD 1,250 49.213 HYPR 3,600 141.732 (Note 4)	2,650 104.331 1,750 68.898	∅1	—		
Reflective	Threaded	M3 	Tough Bending durability R2		STD 200 7.874 HYPR 750 29.528	450 17.717 310 12.205	150 μm / ±3°	IP67	-55 to +80 °C -67 to +176 °F	
		M4 	Tough Bending durability R2		STD 200 7.874 HYPR 750 29.528	450 17.717 310 12.205				
	M6 	Tough Bending durability R4	STD 620 24.409 HYPR 1,630 64.173		1,180 46.457 870 34.252	—				
	Coaxial, Lens mountable	M3 	Tough Bending durability R2		STD 320 12.598 HYPR 1,150 45.276	730 28.740 420 16.535	—	IP40		
		M4 	Tough Bending durability R2		STD 320 12.598 HYPR 1,150 45.276	730 28.740 420 16.535				

Notes: 1) Note that the sensing range of the free-cut type fiber may be reduced by 20 % max. depending upon how the fiber is cut.
 2) The sensing range of reflective type is specified for white non-glossy paper.
 3) Thru-beam sensors are available as two pieces per set.
 4) The fiber cable length practically limits the sensing range.

SPECIFICATIONS

Item	Type	Discrete wire type	M12 connector type
	Model No.	FX-551L3-P-C2	FX-551L3-P-J
Regulatory compliance		EMC Directive, RoHS Directive	
Supply voltage		12 to 24 V DC $\pm 10\%$ Ripple P-P 10 % or less	
Power consumption		Normal operation: 960 mW or less (current consumption 40 mA or less at 24 V supply voltage) ECO mode: 720 mW or less (current consumption 30 mA or less at 24 V supply voltage)	
Communication output (C/Q) (Note 2)	IO-Link communication	IO-Link Specification V1.1	
	Baud rate	COM3 (230.4 kbps)	
	Process data	4 byte	
	Minimum cycle time	1.0 ms	
Control output (DO)	PNP open-collector transistor <ul style="list-style-type: none"> • Maximum source current: 50 mA • Applied voltage: 30 V DC or less (between output and +V) • Residual voltage: 2 V or less (Note 3) (at maximum source current) 		
	Output operation	Switchable either Light-ON or Dark-ON by L/D mode	
	Short-circuit protection	Incorporated	
Response time		STD: 250 μ s or less, LONG: 2 ms or less, U-LG: 4 ms or less, HYPR: 24 ms or less, selectable	
Sensitivity setting		2-point teaching / Limit teaching / Full-auto teaching / Manual adjustment	
Incident light sensitivity setting		Incorporated, 4 steps	
Incident light intensity display range		STD: 0 to 4,000, LONG: 0 to 8,000, U-LG / HYPR: 0 to 9,999	
Timer function		Incorporated with variable OFF-delay / ON-delay / One-shot, switchable either effective or ineffective	
	Timer period	0.1 to 999.9 ms approx., in units of 0.1 ms approx.	
Different frequency interference prevention function (Note 4)		Incorporated (up to 4 units). Note that the response time varies depending on the setting. F-1: 0.8 ms or less, F-2: 0.9 ms or less, F-3: 1.0 ms or less, F-4: 1.7 ms or less	
Protection		IP40 (IEC)	
Ambient temperature		-10 to +55 °C +14 to +131 °F (If 4 to 7 units are mounted in cascade: -10 to +50 °C +14 to +122 °F or if 8 to 16 units are mounted in cascade: -10 to +45 °C +14 to +113 °F) (No dew condensation or icing allowed), Storage: -20 to +70 °C -4 to +158 °F	
Emitting element (modulated)		Red LED (Peak emission wavelength: 660 nm 0.026 mil)	
Material		Enclosure, Case cover: Polycarbonate, Switch: Polyacetal	
Cable		0.2 mm ² 4-core cabtyre cable, 2 m 6.562 ft long	0.2 mm ² cabtyre cable with M12 connector, 0.3 m 0.984 ft long
Cable extension		Extension up to total 20 m 65.617 ft is possible with 0.3 mm ² , or more, cable. (Condition of CE compliance: less than 20 m 65.617 ft) (however, supply voltage 12 V DC or more)	
Weight		Net weight: 55 g approx., Gross weight: 80 g approx.	Net weight: 35 g approx., Gross weight: 60 g approx.

Notes: 1) Where measurement conditions have not been specified precisely, the conditions used were an ambient temperature of +23 °C **+73.4 °F**.

2) When the sensor is used as an ordinary sensor, the communication output (C/Q) provides the same output operation as the control output (DO).

3) In case of using the cable (cable length 2 m **6.562 ft**).

4) This function increases the hysteresis. Check the sensing condition when using the function.

WIRING DIAGRAMS

FX-551L3-P-C2

Discrete wire type

<When using as an ordinary sensor>

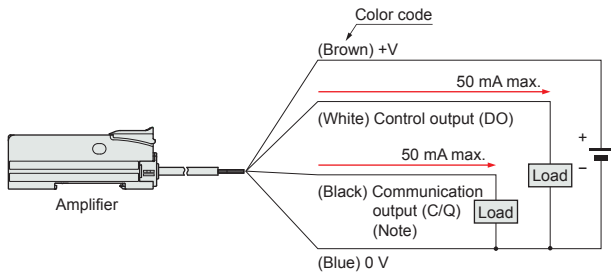

<When connecting to the IO-Link master>

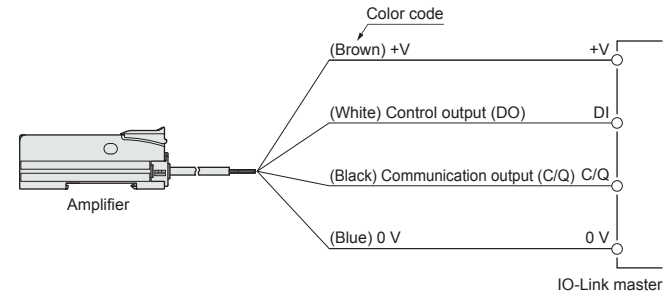

Note: When the sensor is used as an ordinary sensor, the communication output (C/Q) provides the same output operation as the control output (DO).

FX-551L3-P-J

M12 connector type

<When using as an ordinary sensor>

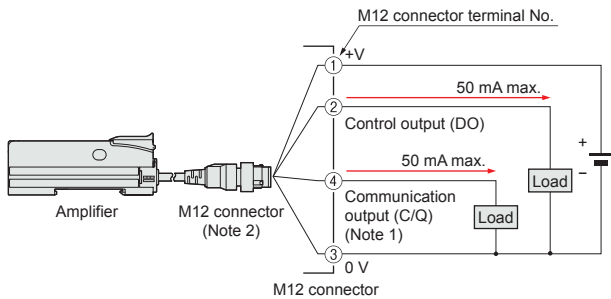

<When connecting to the IO-Link master>

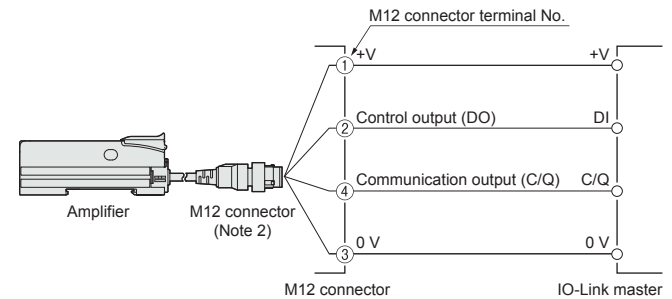

Notes: 1) When the sensor is used as an ordinary sensor, the communication output (C/Q) provides the same output operation as the control output (DO).
2) When wiring with the discrete wire or extending the cable from the M12 connector, separately prepare commercially available M12 connector cable.

M12 connector terminal arrangement diagram

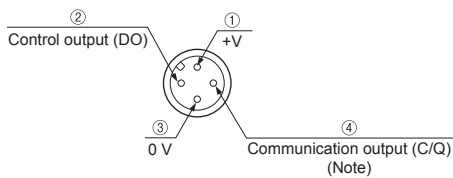

Terminal No.	Designation
①	+V
②	Control output (DO)
③	0 V
④	Communication output (C/Q) (Note)

Note: When the sensor is used as an ordinary sensor, the communication output (C/Q) provides the same output operation as the control output (DO).

PRECAUTIONS FOR PROPER USE

• This catalog is a guide to select a suitable product. Be sure to read instruction manual attached to the product prior to its use.



- Never use this product as a sensing device for personnel protection.
- In case of using sensing devices for personnel protection, use products which meet laws and standards, such as OSHA, ANSI or IEC etc., for personnel protection applicable in each region or country.

Wiring

- Make sure that the power supply is OFF while adding or removing the amplifiers.

- Note that if a voltage exceeding the rated range is applied, or if an AC power supply is directly connected, the product may get burnt or damaged.
- Note that short-circuit of the load or wrong wiring may burn or damage the product.
- Do not run the wires together with high-voltage lines or power lines, or put them in the same raceway. This can cause malfunction due to induction.
- Verify that the supply voltage variation is within the rating.
- If power is supplied from a commercial switching regulator, ensure that the frame ground (F.G.) terminal of the power supply is connected to an actual ground.
- In case noise generating equipment (switching regulator, inverter motor, etc.) is used in the vicinity of this product, connect the frame ground (F.G.) terminal of the equipment to an actual ground.
- Make sure that stress by forcible bending or pulling is not applied to the sensor cable joint and fiber cable.

PRECAUTIONS FOR PROPER USE

Others

- This product has been developed / produced for industrial use only.
- The specification may not be satisfied in a strong magnetic field.
- The ultra long distance (U-LG, HYPR) mode is more likely to be affected by extraneous noise since the sensitivity of that is higher than the other modes. Make sure to check the environment before use.
- Do not use during the initial transient time (STD: 0.5 sec., LONG, U-LG, HYPR: 1 sec.) after the power supply is switched ON.
- These sensors are only for indoor use.
- Avoid dust, dirt, and steam.
- Make sure that the product does not come in contact with oil, grease, organic solvents such as thinner, etc., strong acid or alkaline.
- This product cannot be used in an environment containing inflammable or explosive gases.
- Never disassemble or modify this product.
- This product adopts EEPROM. Settings cannot be done a million times or more because of the EEPROM's lifetime.

DIMENSIONS (Unit: mm in)

The CAD data can be downloaded from our website.

FX-551L3-P-J

Amplifier

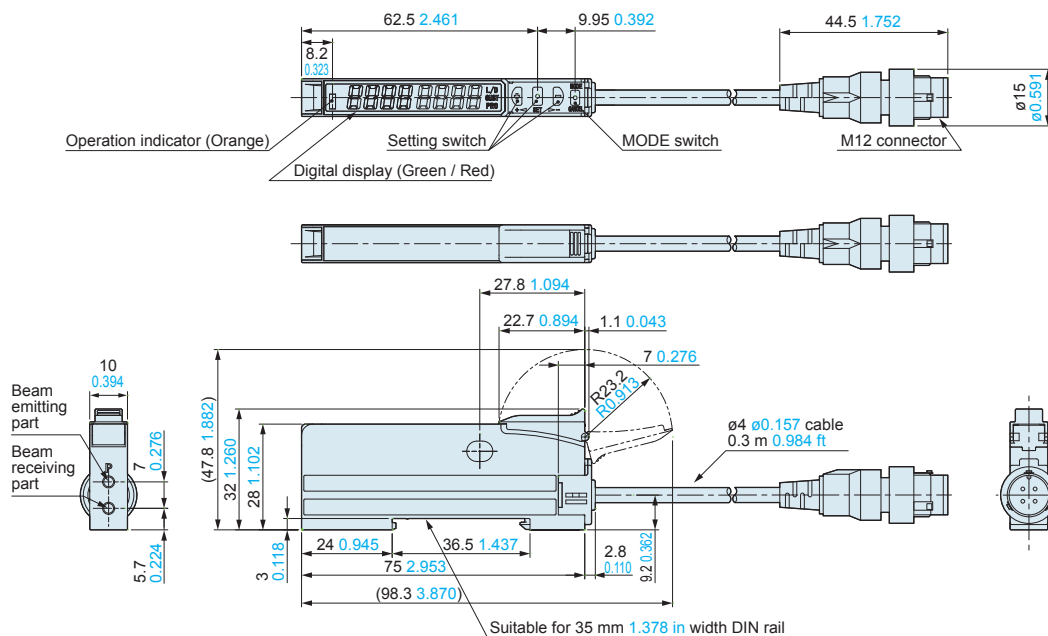

FX-551L3-P-C2

Amplifier

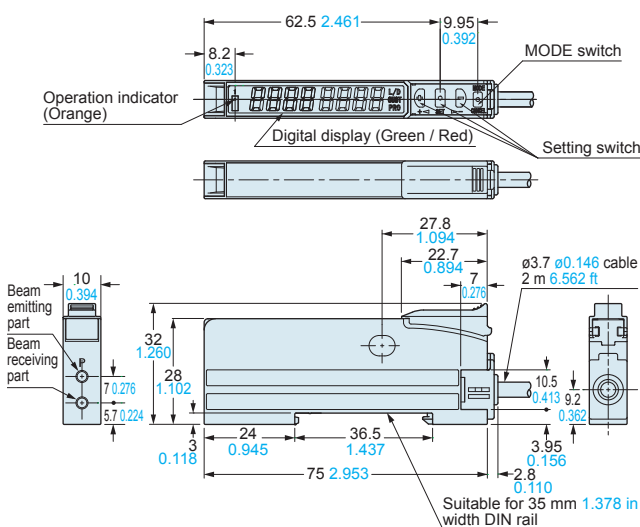

MS-DIN-2

Amplifier mounting bracket (Optional)

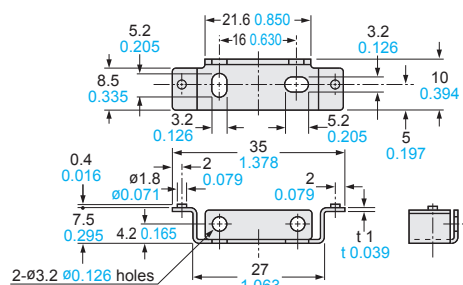

MS-DIN-E

End plate (Optional)

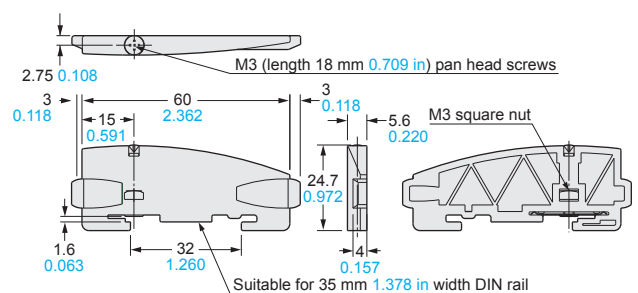

ORDER GUIDE

Model No.

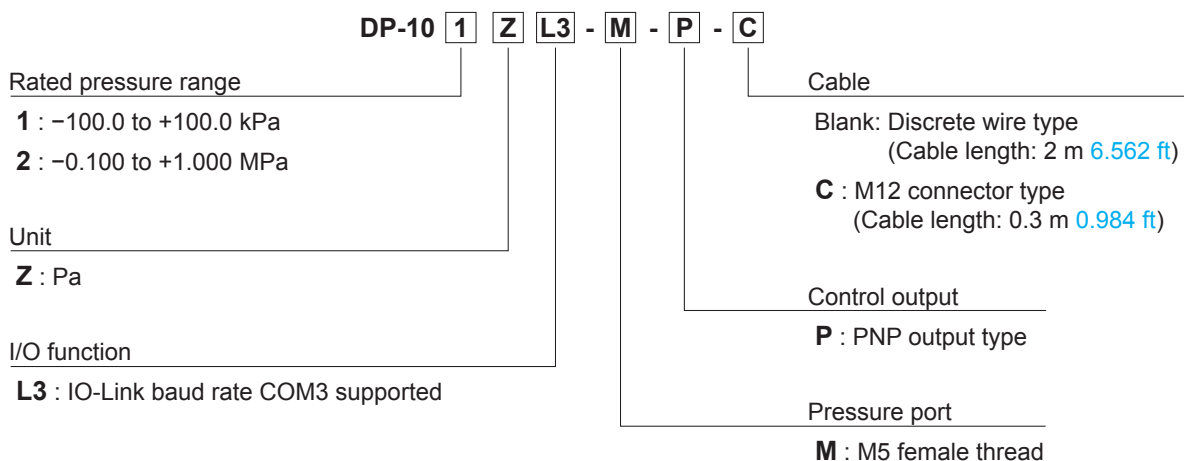

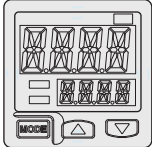
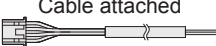
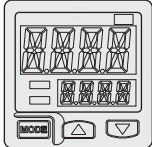
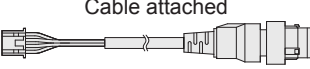
Type		Appearance	Rated pressure range	Model No.	Pressure port	Control output
Discrete wire type	For low pressure		-100.0 to +100.0 kPa	DP-101ZL3-M-P	M5 female thread	PNP open-collector transistor
	For high pressure	 Cable attached	-0.100 to +1.000 MPa	DP-102ZL3-M-P		
M12 connector type	For low pressure		-100.0 to +100.0 kPa	DP-101ZL3-M-P-C		
	For high pressure	 Cable attached Supports Smartclick (Note)	-0.100 to +1.000 MPa	DP-102ZL3-M-P-C		

Note: Smartclick is a registered trademark of OMRON Corporation.

Accessory

- **CN-14A-C2** (Connector attached cable 2 m **6.562 ft**)



* M12 connector cable (0.3 m **0.984 ft**) is not sold separately.

OPTIONS

Designation	Model No.	Description	
Connector attached cable	CN-14A-C1	Length: 1 m 3.281 ft	Discrete wires 0.2 mm ² 4-core cabtyre cable with connector on one end Cable outer diameter: \varnothing 3.7 mm \varnothing 0.146 in
	CN-14A-C2 (Note)	Length: 2 m 6.562 ft	
	CN-14A-C3	Length: 3 m 9.843 ft	
	CN-14A-C5	Length: 5 m 16.404 ft	
Connector attached cable (Bending-resistant cable)	CN-14A-R-C1	Length: 1 m 3.281 ft	Discrete wires 0.2 mm ² 4-core bending-resistant cabtyre cable with connector on one end Cable outer diameter: \varnothing 3.7 mm \varnothing 0.146 in
	CN-14A-R-C2	Length: 2 m 6.562 ft	
	CN-14A-R-C3	Length: 3 m 9.843 ft	
	CN-14A-R-C5	Length: 5 m 16.404 ft	
Connector	CN-14A	Set of 10 housings and 40 contacts	
Sensor mounting bracket	MS-DP1-1	Allows sensors to be installed on the flooring or ceiling. Multiple sensors can also be mounted closely.	
	MS-DP1-5	Allows sensors to be installed on the wall. Multiple sensors can also be mounted closely.	
Panel mounting bracket	MS-DP1-2	Allows installation to panels with thickness of 1 to 6 mm 0.039 to 0.236 in . Multiple sensors can also be mounted closely.	
	MS-DP1-4	Allows replacement from DP2 / DP3 series to DP-100L series. For newly designed set-up, please use panel mounting bracket MS-DP1-2 for panel mounting.	
Front protection cover	MS-DP1-3	Protects the adjustment surfaces of sensors. (Can be attached when using the panel mounting bracket MS-DP1-2)	
	DPX-04	Protects the adjustment surfaces of sensors. (Can be attached when using the panel mounting bracket MS-DP1-4)	
Conversion bushing	MS-DP1-7	By equipping with the sensor, pressure port can be converted to Rc ¹ / ₈ female thread. Replacement from DP2 / DP3 series is possible.	
Flat attachment	MS-DP1-FM	M5 female thread	Pressure port and cable can now be pulled out in downward, left or right directions. Flat mounting on surfaces such as the wall is made possible.
	MS-DP1-FR	Rc ¹ / ₈ female thread	
	MS-DP1-FN	NPT ¹ / ₈ female thread	
	MS-DP1-FE	G ¹ / ₈ female thread	

Note: The connector attached cable **CN-14A-C2** is supplied with **DP-10** \square **ZL3-M-P**.

Panel mounting bracket, Front protection cover

- **MS-DP1-2**
- **MS-DP1-3**

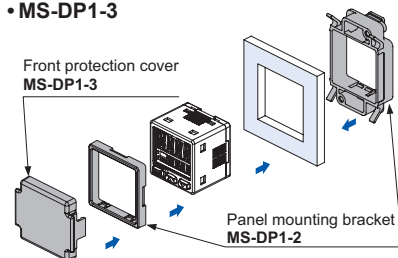

- **MS-DP1-4**

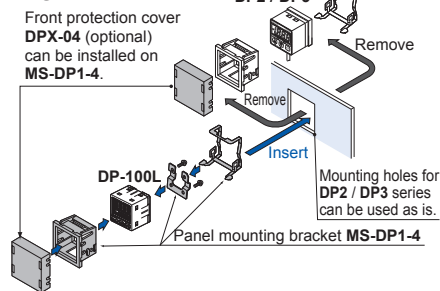
**Flat attachment**

- **MS-DP1-FM**

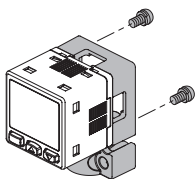

- **MS-DP1-FR**
- **MS-DP1-FN**
- **MS-DP1-FE**

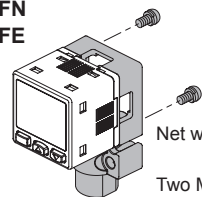

Net weight: **MS-DP1-FM** 15g approx.
MS-DP1-FR/FN/FE 25g approx.
Two M3 (length 8 mm **0.315 in**) screws, two M4 (length 20 mm **0.787 in**) screws are attached.

Connector attached cable

- **CN-14A-C** \square
- **CN-14A-R-C** \square

**Sensor mounting bracket**

- **MS-DP1-1**

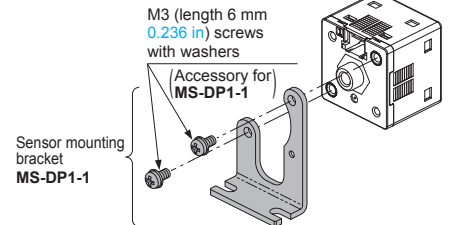

- **MS-DP1-5**

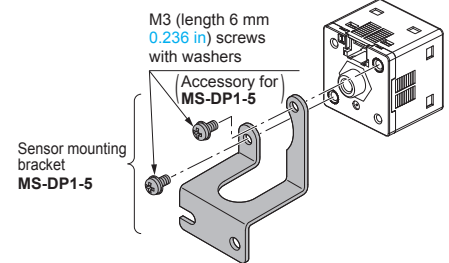
**Conversion bushing**

- **MS-DP1-7**

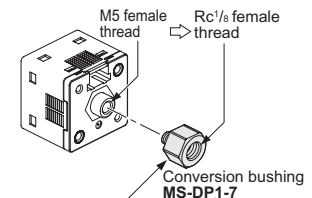
**Recommended connector***

Manufactured by J.S.T. Mfg. Co.,Ltd.
Contact: SPHD-001T-P0.5
Housing: PAP-04V-S

Recommended crimping tool*

Manufactured by J.S.T. Mfg. Co.,Ltd.
Model No.: YC-610R

Recommended connector (e-CON)*

Manufactured by 3M Japan Limited
Applicable connector: 37104-3122-000 FL

Recommended extension cables for M12 connector type*

Manufactured by OMRON Corporation
Extension cable with connectors on both ends XS5W series



Smartclick is a registered trademark of OMRON Corporation.

* Contact the manufacturer for details of the recommended products.

SPECIFICATIONS

Type		Discrete wire type		M12 connector type	
		For low pressure	For high pressure	For low pressure	For high pressure
Item	Model No.	DP-101ZL3-M-P	DP-102ZL3-M-P	DP-101ZL3-M-P-C	DP-102ZL3-M-P-C
Regulatory compliance and certification		EMC Directive, RoHS Directive, UL/c-UL Certification			
Type of pressure		Gauge pressure			
Rated pressure range		-100.0 to +100.0 kPa	-0.100 to +1.000 MPa	-100.0 to +100.0 kPa	-0.100 to +1.000 MPa
Set pressure range		-101.0 to +101.0 kPa	-0.101 to +1.010 MPa	-101.0 to +101.0 kPa	-0.101 to +1.010 MPa
Pressure withstandability		500 kPa	1.5 MPa	500 kPa	1.5 MPa
Applicable fluid		Non-corrosive gas			
Supply voltage		12 to 24 V DC $\pm 10\%$ Ripple P-P 10 % or less			
Power consumption (Note 2)		Normal operation: 720 mW or less (Current consumption 30 mA or less at 24 V supply voltage) ECO mode: 480 mW or less at STD (Current consumption 20 mA or less at 24 V supply voltage) 360 mW or less at FULL (Current consumption 15 mA or less at 24 V supply voltage)			
Communication output (C/Q) (Note 3)	IO-Link communication	IO-Link Specification V1.1			
	Baud rate	COM3 (230.4 kbps)			
	Process data	4 byte			
	Minimum cycle time	1.0 ms			
Control output (DO)		PNP open-collector transistor • Maximum source current: 50 mA • Applied voltage: 30 V DC or less (between output and +V) • Residual voltage: 2 V or less (at 50 mA source current)			
Output operation		NO/NC (selectable by key operation)			
Output modes		EASY mode / Hysteresis mode / Window comparator mode			
Hysteresis		Minimum 1 digit (variable)			
Repeatability		$\pm 0.1\%$ F.S. (within ± 2 digits)	$\pm 0.2\%$ F.S. (within ± 2 digits)	$\pm 0.1\%$ F.S. (within ± 2 digits)	$\pm 0.2\%$ F.S. (within ± 2 digits)
Response time		2.5 ms, 5 ms, 10 ms, 25 ms, 50 ms, 100 ms, 250 ms, 500 ms, 1,000 ms, 5,000 ms, selectable by key operation			
Short-circuit protection		Incorporated			
Display		4 digits + 4 digits 3-color LCD display (Display refresh rate: 250 ms, 500 ms, 1,000 ms, selectable by key operation)			
Displayable pressure range		-101.0 to +101.0 kPa	-0.101 to +1.010 MPa	-101.0 to +101.0 kPa	-0.101 to +1.010 MPa
Output indicator		Orange LED (Output operation indicator 1: Flashes during IO-Link communication, Lights up when the control output is ON during non-IO-Link communication (synchronized with the output operation indicator 2) Output operation indicator 2: Lights up when the control output is ON)			
Environmental resistance	Protection	IP40 (IEC)			
	Ambient temperature	-10 to +50 °C +14 to +122 °F (No dew condensation or icing allowed), Storage: -10 to +60 °C +14 to +140 °F			
	Ambient humidity	35 to 85 % RH, Storage: 35 to 85 % RH			
	Voltage withstandability	1,000 V AC for one min. between all supply terminals connected together and enclosure			
	Insulation resistance	50 M Ω or more with 500 V DC megger between all supply terminals connected together and enclosure			
	Vibration resistance	10 to 500 Hz frequency, 3 mm 0.118 in double amplitude or maximum acceleration 196 m/s ² , in X, Y and Z directions for two hours each (when panel or flat attachment is mounted: 10 to 150 Hz frequency, 0.75 mm 0.030 in double amplitude or maximum acceleration 49 m/s ² , in X, Y and Z directions for two hours each)			
Shock resistance		100 m/s ² acceleration (10 G approx.) in X, Y and Z directions three times each			
Temperature characteristics		Within $\pm 0.5\%$ F.S. (at +20 °C +68 °F)	Within $\pm 1\%$ F.S. (at +20 °C +68 °F)	Within $\pm 0.5\%$ F.S. (at +20 °C +68 °F)	Within $\pm 1\%$ F.S. (at +20 °C +68 °F)
Pressure port		M5 female thread			
Material		Enclosure: PBT (glass fiber reinforced), LCD display: Acrylic, Pressure port: Stainless steel (SUS303), Mounting threaded part: Brass (nickel plated), Switch part: Silicone rubber			
Connecting method		Connector			
Cable length		Total length up to 20 m 65.617 ft (Condition of CE compliance less than 20 m 65.617 ft) is possible with 0.3 mm ² , or more, cable.			
Weight		Net weight: 30 g approx., Gross weight: 125 g approx.		Net weight: 30 g approx., Gross weight: 95 g approx.	
Accessories		CN-14A-C2 (Connector attached cable 2 m 6.562 ft): 1 pc.		Dedicated M12 connector cable, 0.3 m 0.984 ft long: 1 pc.	

Notes: 1) Where measurement conditions have not been specified precisely, the conditions used were an ambient temperature of +20 °C **+68 °F**.

2) The power consumption does not include the output load current.

3) When the sensor is used as an ordinary sensor, the communication output (C/Q) provides the same output operation as the control output (DO).

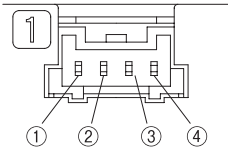
WIRING DIAGRAMS**Terminal arrangement diagram of the connector on the sensor side**

Terminal No.	Designation
①	+V
②	Communication output (C/Q) (Note)
③	Control output (DO)
④	0 V

Note: When the sensor is used as an ordinary sensor, the communication output (C/Q) provides the same output operation as the control output (DO).

WIRING DIAGRAMS**DP-10□ZL3-M-P**

Discrete wire type

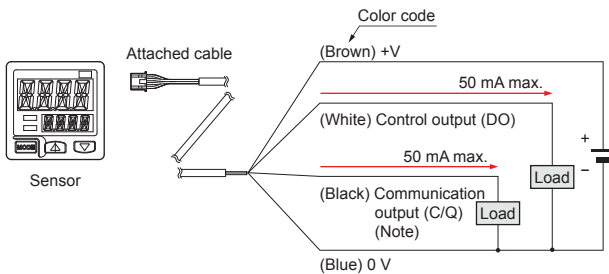
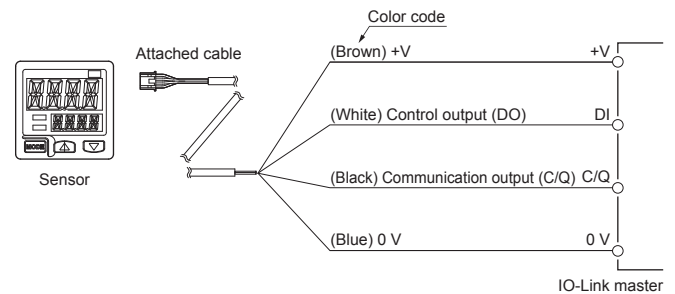
<When using as an ordinary sensor>**<When connecting to the IO-Link master>**

Note: When the sensor is used as an ordinary sensor, the communication output (C/Q) provides the same output operation as the control output (DO).

DP-10□ZL3-M-P-C

M12 connector type

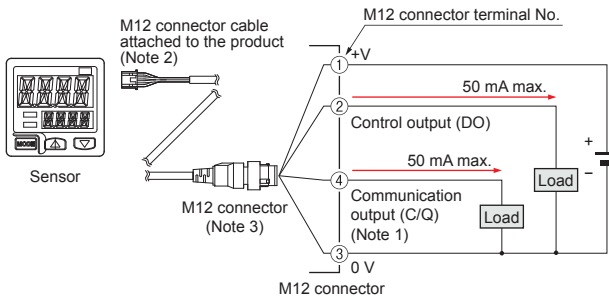
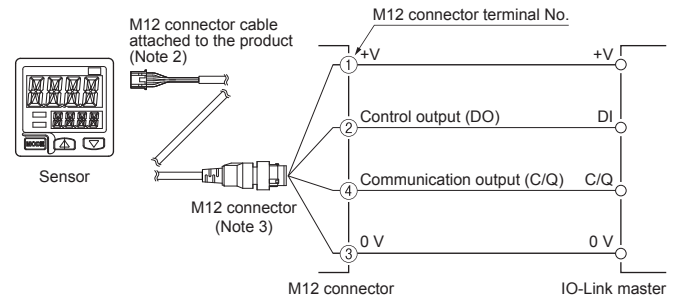
<When using as an ordinary sensor>**<When connecting to the IO-Link master>**

- Notes: 1) When the sensor is used as an ordinary sensor, the communication output (C/Q) provides the same output operation as the control output (DO).
 2) Be sure to use the dedicated M12 connector cable attached to the product. Note that the pin arrangement is different from that for commercially available M12 connector cables.
 3) When wiring with the discrete wire or extending the cable from the dedicated M12 connector attached to the product, separately prepare commercially available M12 connector cable.

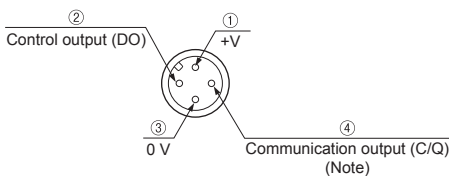
M12 connector terminal arrangement diagram

Terminal No.	Designation
①	+V
②	Control output (DO)
③	0 V
④	Communication output (C/Q) (Note)

Note: When the sensor is used as an ordinary sensor, the communication output (C/Q) provides the same output operation as the control output (DO).

PRECAUTIONS FOR PROPER USE

• This catalog is a guide to select a suitable product. Be sure to read instruction manual attached to the product prior to its use.



- Never use this product as a sensing device for personnel protection.
- In case of using sensing devices for personnel protection, use products which meet laws and standards, such as OSHA, ANSI or IEC etc., for personnel protection applicable in each region or country.
- The **DP-100L** series is designed for use with non-corrosive gas. It cannot be used with liquid or corrosive gas.

Wiring

- Make sure that the power supply is off while wiring.
- Verify that the supply voltage variation is within the rating.
- If power is supplied from a commercial switching regulator, ensure that the frame ground (F.G.) terminal of the power supply is connected to an actual ground.
- In case noise generating equipment (switching regulator, inverter motor, etc.) is used in the vicinity of this sensor, connect the frame ground (F.G.) terminal of the equipment to an actual ground.
- Do not run the wires together with high-voltage lines or power lines or put them in the same raceway. This can cause malfunction due to induction.
- Incorrect wiring will cause problems with operation.

Connection

- Do not apply stress directly to the connection cable leader or to the connector.

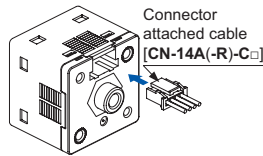

Mounting

- **MS-DP1-1 / MS-DP1-5** sensor mounting brackets are available separately, and it should be used for mounting. When tightening the sensor to the sensor mounting bracket, use a tightening torque of 0.5 N·m or less.

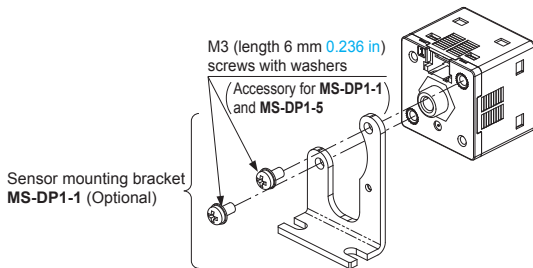

- The **MS-DP1-2** panel mounting bracket (optional) and the **MS-DP1-3** front protection cover (optional) are also available.

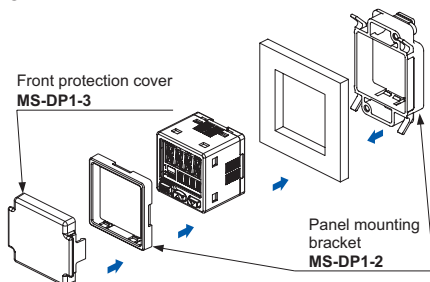

- The **MS-DP1-4** panel mounting bracket is available when switching from the **DP2 / DP3** series.

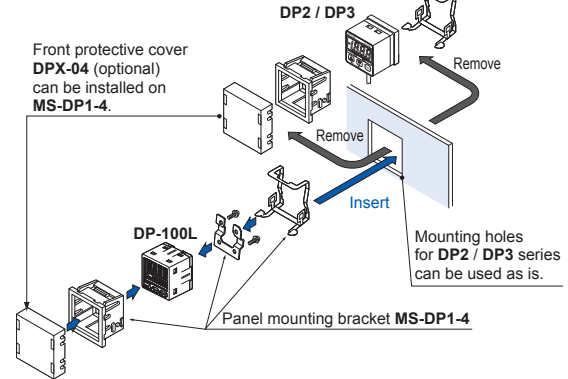

- The **MS-DP1-7** conversion bushing is available. It can be used to switch between this model and the **DP2 / DP3** series. When connecting to the pressure port, use a tightening torque of 1.0 N·m or less.

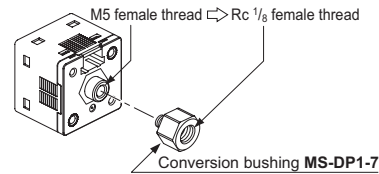

- The **MS-DP1-F** flat attachment is available. If using the **MS-DP1-F** flat attachment (optional), install by following the procedures given below.

- (1) Decide the direction of this product to mount with the sensor.

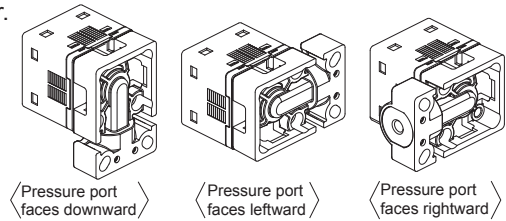

Note: It is not possible to mount this product such that the pressure port faces upward.

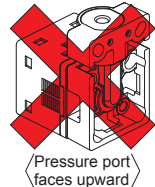

- (2) Mount this product with the M3 female threads of the sensor by using the attached M3 (length 8 mm 0.315 in) screws. The tightening torque should be 0.5 N·m or less.

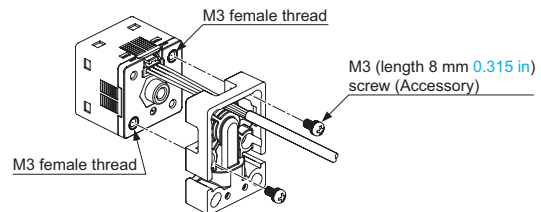

- (3) Mount this product with the mounting surface by using the attached M4 (length 20 mm 0.787 in) screws. The tightening torque should be 1.2 N·m or less.

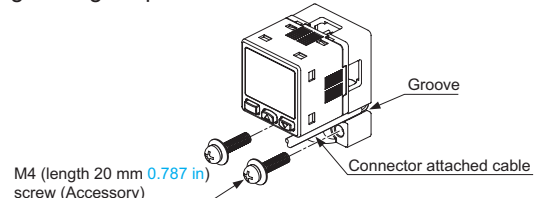

Note: Take care that if the cable with connector is sticking out of the side groove of this product when mounting, the cable may disconnected.

DIMENSIONS (Unit: mm in)

The CAD data can be downloaded from the website.

DP-100L SERIES

MS-DP1-1

Sensor mounting bracket (Optional)

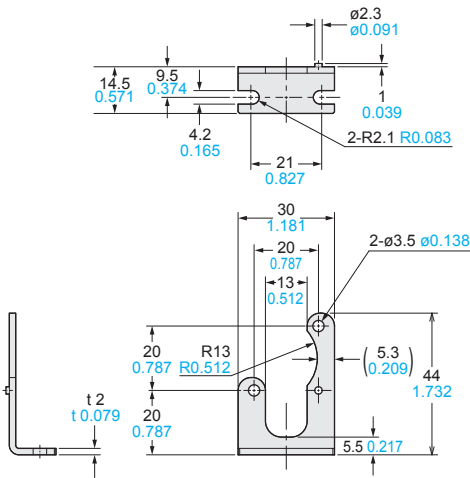

Material: Cold rolled carbon steel (SPCC)
(Trivalent uni-chrome plated)
Two M3 (length 6 mm 0.236 in) screws with washers are attached.

Assembly dimensions

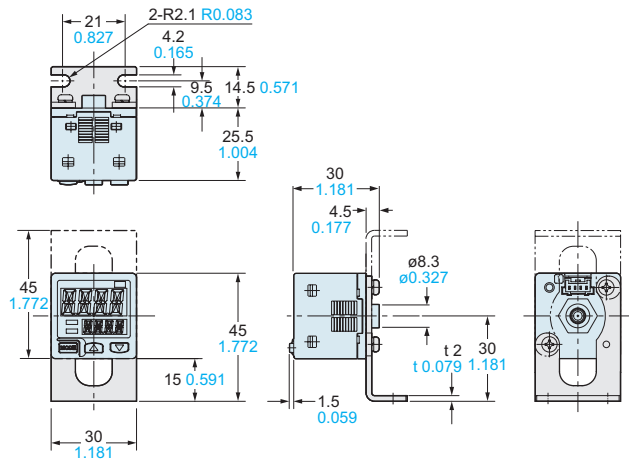

MS-DP1-5

Sensor mounting bracket (Optional)

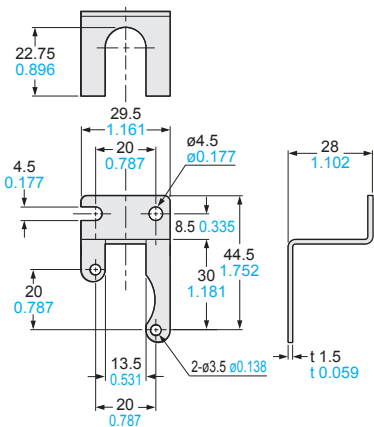

Material: Stainless steel (SUS304)
Two M3 (length 6 mm 0.236 in) screws with washers are attached.

Assembly dimensions

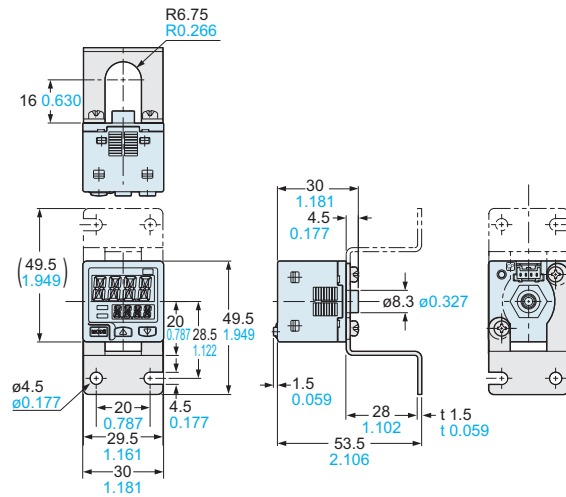

MS-DP1-2 MS-DP1-3

Panel mounting bracket (Optional), Front protection cover (Optional)

Assembly dimensions

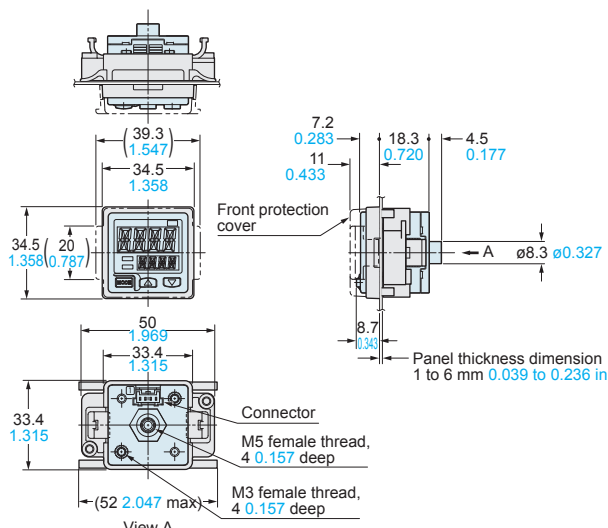

Material: Polyacetal (Panel mounting bracket)
Polycarbonate (Front protection cover)

Panel cut-out dimensions

When 1 unit is installed

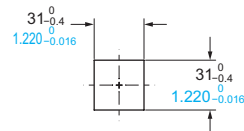

When "n" units are installed horizontally in series

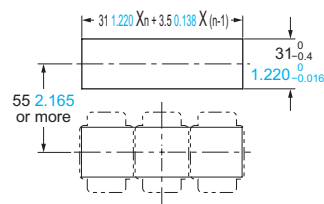

When "n" units are installed vertically in series

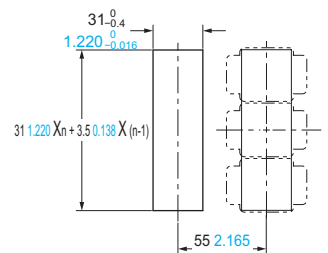

Note: The panel thickness should be 1 to 6 mm 0.039 to 0.236 in.

Note: The panel thickness should be 1 to 6 mm 0.039 to 0.236 in.

DIMENSIONS (Unit: mm in)

The CAD data can be downloaded from the website.

MS-DP1-4

Panel mounting bracket (Optional)

Assembly dimensions

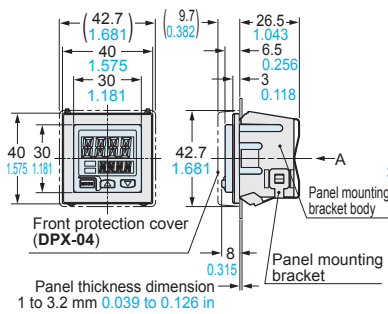

Panel cut-out dimensions

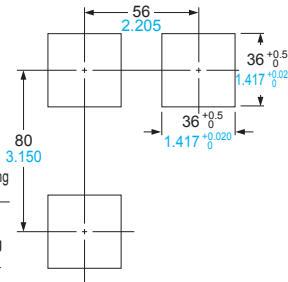

Note: The panel thickness should be 1 to 3.2 mm **0.039 to 0.126 in**.

Material: Nylon 6 (Panel mounting bracket body)
Stainless steel (SUS304) (Panel mounting bracket)
Cold rolled carbon steel (SPCC) (Trivalent uni-chrome plated) (Spacer)

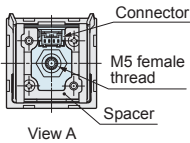

MS-DP1-7

Conversion bushing (Optional)

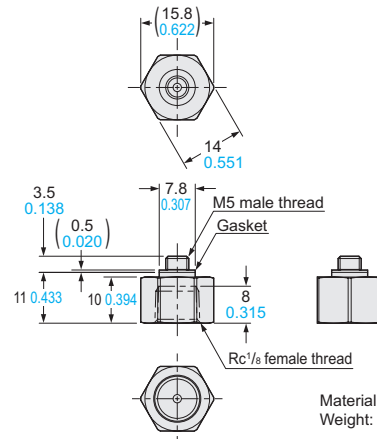

Material: Brass (Nickel plated)
Weight: 10 g approx.

MS-DP1-FM

Flat attachment (Optional)

Assembly dimensions

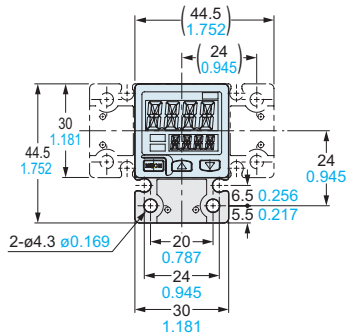

Material: Polybutylene terephthalate (PBT) (Glass fiber reinforced) (Enclosure)
Stainless steel (SUS303) (Pressure port)
Hydrogenated Nitrile Butadiene Rubber (H-NBR) (O-ring)
Weight: 15 g approx. (flat attachment only)

Two M3 (length 8 mm **0.315 in**) screws, two M4 (length 20 mm **0.787 in**) screws are attached.

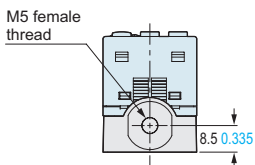

MS-DP1-FR/FN/FE

Flat attachment (Optional)

Assembly dimensions

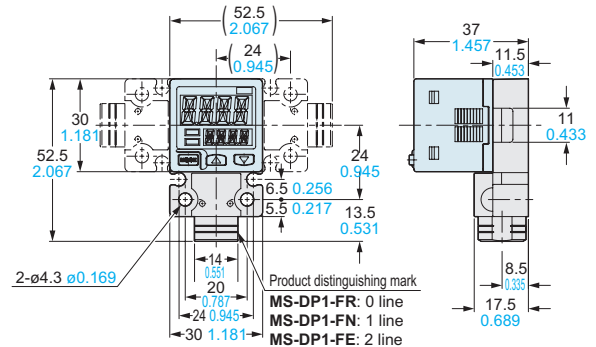

Material: Polybutylene terephthalate (PBT) (Glass fiber reinforced) (Enclosure)
Stainless steel (SUS303) (Pressure port)
Hydrogenated Nitrile Butadiene Rubber (H-NBR) (O-ring)
Weight: 25 g approx. (flat attachment only)

Two M3 (length 8 mm **0.315 in**) screws, two M4 (length 20 mm **0.787 in**) screws are attached.

Note: **MS-DP1-FR** has a Rc 1/8 female thread.
MS-DP1-FN has a NPT 1/8 female thread.

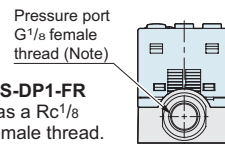

CN-14A(-R)-C

Connector attached cable (Optional, **CN-14A-C2** is attached to **DP-10□ZL3-M-P**)

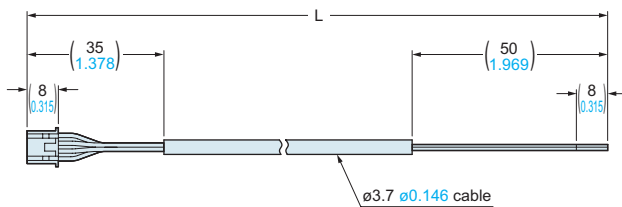

• Length L

Model No.	Length L (mm in)
CN-14A(-R)-C1	1,000 39.370
CN-14A(-R)-C2	2,000 78.740
CN-14A(-R)-C3	3,000 118.110
CN-14A(-R)-C5	5,000 196.850

Dedicated M12 connector cable (attached to DP-10□ZL3-M-P-C)

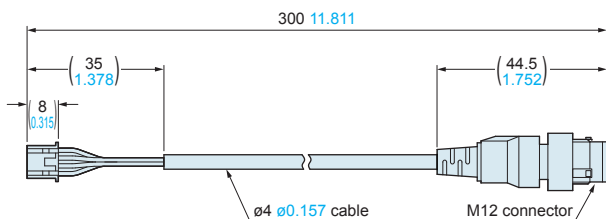

Note: Be sure to use the dedicated M12 connector cable attached to the product. Note that the pin arrangement is different from that for commercially available M12 connector cables.

ORDER GUIDE

Type	Appearance	Measurement center distance and measurement range	Repeatability	Beam diameter (Note)	Model No.	Control output
Discrete wire type		Measurement center 30 mm 1.181 in type	30 ±5 mm 1.181 ±0.197 in	10 μm 0.394 mil	ø50 μm 1.969 mil approx.	HG-C1030L3-P
		Measurement center 50 mm 1.969 in type	50 ±15 mm 1.969 ±0.591 in	30 μm 1.181 mil	ø70 μm 2.756 mil approx.	HG-C1050L3-P
		Measurement center 100 mm 3.937 in type	100 ±35 mm 3.937 ±1.328 in	70 μm 2.756 mil	ø120 μm 4.724 mil approx.	HG-C1100L3-P
		Measurement center 200 mm 7.874 in type	200 ±80 mm 7.874 ±3.150 in	200 μm 7.874 mil	ø300 μm 11.811 mil approx.	HG-C1200L3-P
		Measurement center 400 mm 15.748 in type	400 ±200 mm 15.748 ±7.874 in	300 μm 11.811 mil (Measuring distance 200 to 400 mm 7.874 to 15.748 in) 800 μm 31.496 mil (Measuring distance 400 to 600 mm 15.748 to 23.622 in)	ø500 μm 19.685 mil approx.	HG-C1400L3-P
M12 connector type		Measurement center 30 mm 1.181 in type	30 ±5 mm 1.181 ±0.197 in	10 μm 0.394 mil	ø50 μm 1.969 mil approx.	HG-C1030L3-P-J
		Measurement center 50 mm 1.969 in type	50 ±15 mm 1.969 ±0.591 in	30 μm 1.181 mil	ø70 μm 2.756 mil approx.	HG-C1050L3-P-J
		Measurement center 100 mm 3.937 in type	100 ±35 mm 3.937 ±1.328 in	70 μm 2.756 mil	ø120 μm 4.724 mil approx.	HG-C1100L3-P-J
		Measurement center 200 mm 7.874 in type	200 ±80 mm 7.874 ±3.150 in	200 μm 7.874 mil	ø300 μm 11.811 mil approx.	HG-C1200L3-P-J
		Measurement center 400 mm 15.748 in type	400 ±200 mm 15.748 ±7.874 in	300 μm 11.811 mil (Measuring distance 200 to 400 mm 7.874 to 15.748 in) 800 μm 31.496 mil (Measuring distance 400 to 600 mm 15.748 to 23.622 in)	ø500 μm 19.685 mil approx.	HG-C1400L3-P-J

PNP open-collector transistor

Notes: 1) This is the size in the measurement center distance. These values were defined by using $1/e^2$ (13.5% approx.) of the center light intensity. Due to leak light outside the specified area, the reflectance around the detecting point may be higher than at the point and this may affect the measurement value.

2) Smartclick is a registered trademark of OMRON Corporation.

OPTIONS

Designation	Model No.	Description
Simple mounting bracket (Note)	MS-HG-01	Foot angled mounting bracket

Note: Due to the simple mounting bracket, the sensing characteristics may not be hold depending on the installation condition, in case of the purposes for acquiring the displacement data and a fine detecting.

Simple mounting bracket

• MS-HG-01

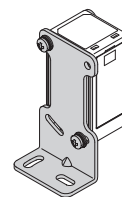

Material: Stainless steel (SUS304)

Two M3 (length 25 mm 0.984 in) screws with washers (SPCC) are attached.

Recommended extension cables for M12 connector type

Manufactured by OMRON Corporation

Extension cable with connectors on both ends XS5W series

* Smartclick is a registered trademark of OMRON Corporation. Contact the manufacturer for details of the recommended products.

WIRING DIAGRAMS

HG-C□L3-P

Discrete wire type

<When using as an ordinary sensor>

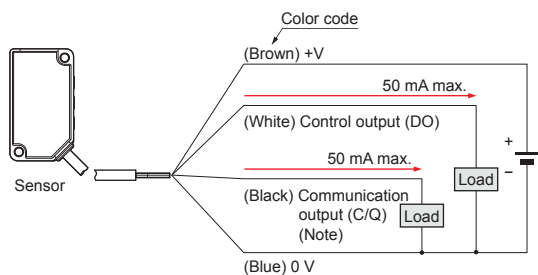

<When connecting to the IO-Link master>

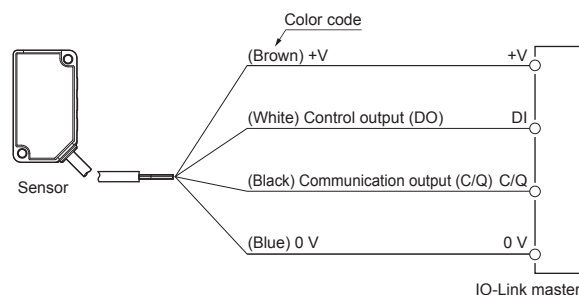

Note: When the sensor is used as an ordinary sensor, the communication output (C/Q) provides the same output operation as the control output (DO).

HG-C□L3-P-J

M12 connector type

<When using as an ordinary sensor>

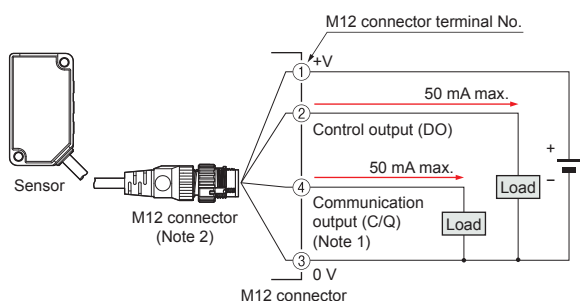

<When connecting to the IO-Link master>

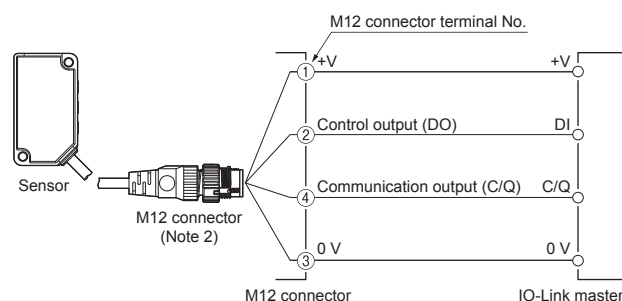

Notes: 1) When the sensor is used as an ordinary sensor, the communication output (C/Q) provides the same output operation as the control output (DO).
2) When wiring with the discrete wire or extending the cable from the M12 connector, separately prepare commercially available M12 connector cable.

M12 connector terminal arrangement diagram

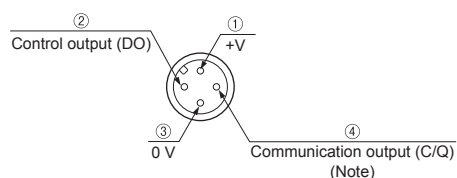

Terminal No.	Designation
①	+V
②	Control output (DO)
③	0 V
④	Communication output (C/Q) (Note)

Note: When the sensor is used as an ordinary sensor, the communication output (C/Q) provides the same output operation as the control output (DO).

SPECIFICATIONS

Item	Model No.	Type	Measurement center 30 mm 1.181 in type	Measurement center 50 mm 1.969 in type	Measurement center 100 mm 3.937 in type	Measurement center 200 mm 7.874 in type	Measurement center 400 mm 15.748 in type
		Discrete wire	HG-C1030L3-P	HG-C1050L3-P	HG-C1100L3-P	HG-C1200L3-P	HG-C1400L3-P
		M12 connector	HG-C1030L3-P-J	HG-C1050L3-P-J	HG-C1100L3-P-J	HG-C1200L3-P-J	HG-C1400L3-P-J
Regulatory compliance and certification		EMC Directive, RoHS Directive, FDA Regulations, UL/c-UL Certification					
Measurement center distance		30 mm 1.181 in	50 mm 1.969 in	100 mm 3.937 in	200 mm 7.874 in	400 mm 15.748 in	
Measurement range		±5 mm 0.197 in	±15 mm 0.591 in	±35 mm 1.328 in	±80 mm 3.150 in	±200 mm 7.874 in	
Repeatability		10 μm 0.394 mil	30 μm 1.181 mil	70 μm 2.756 mil	200 μm 7.874 mil	300 μm 11.811 mil (Measuring distance 200 to 400 mm 7.874 to 15.748 in) 800 μm 31.496 mil (Measuring distance 400 to 600 mm 15.748 to 23.622 in)	
Linearity		±0.1 % F.S.			±0.2 % F.S.		±0.2 % F.S. (Measuring distance 200 to 400 mm 7.874 to 15.748 in) ±0.3 % F.S. (Measuring distance 400 to 600 mm 15.748 to 23.622 in)
Temperature characteristic		0.03 % F.S./°C					
Light source		Red semiconductor laser Class 2 [IEC / JIS / GB / FDA (Note 2)] Max. output: 1 mW, emission peak wavelength: 655 nm 0.026 mil					
Beam diameter (Note 3)		ø50 μm 1.969 mil approx.	ø70 μm 2.756 mil approx.	ø120 μm 4.724 mil approx.	ø300 μm 11.811 mil approx.	ø500 μm 19.685 mil approx.	
Supply voltage		24 V DC ±10 % Ripple P-P 10 %					
Power consumption		40 mA or less (at 24 V DC supply voltage)					
Communication output (C/Q) (Note 4)		IO-Link communication					
		IO-Link Specification V1.1					
		Baud rate					
		COM3 (230.4 kbps)					
		Process data					
		4 byte					
		Minimum cycle time					
		1.0 ms					
Control output (DO)		PNP open-collector transistor <ul style="list-style-type: none"> • Maximum source current: 50 mA • Applied voltage: 30 V DC or less (Between control output to +V) • Residual voltage: 1.5 V or less (at 50 mA source current) • Leakage current: 0.1 mA or less 					
Output operation		Switchable between either Light-ON or Dark-ON					
Short-circuit protection		Incorporated (auto reset type)					
Response time		Switchable between 1.5 ms / 5 ms / 10 ms					
Pollution degree		2					
Ambient altitude		2,000 m 6561.680 ft or less					
Environmental resistance		IP67 (IEC)					
Protection		IP67 (IEC)					
Ambient temperature		-10 to +45 °C -14 to 113 °F (No dew condensation or icing allowed), Storage: -20 to +60 °C -4 to 140 °F					
Ambient humidity		35 to 85 % RH, Storage: 35 to 85 % RH					
Ambient illuminance		Incandescent light: 3,000 lx or less at the light-receiving face					
Vibration resistance		10 to 55 Hz (period: 1 min.) frequency, 1.5 mm 0.059 in double amplitude in X, Y and Z directions for two hours each					
Shock resistance		500 m/s ² acceleration (50 G approx.) in X, Y and Z directions three times each					
Cable		Discrete wire type: 0.2 mm ² 4-core PVC cable, 2 m 6.562 ft long M12 connector type: 0.2 mm ² 4-core PVC cable with connector, 0.3 m 0.984 ft long					
Cable extension		Extension up to total 20 m 65.617 ft is possible with 0.3 mm ² , or more, cable.					
Material		Enclosure: Aluminum die-cast, Front cover: Acrylic					
Weight		Discrete wire type: 30 g approx. (without cable), 80 g approx. (including cable) M12 connector type: 30 g approx. (without cable), 50 g approx. (including cable)					

- Notes: 1) Supply voltage: 24 V DC, ambient temperature: +20 °C **+68 °F**, response time: 10 ms, and analog output value of measurement center distance are used for unspecified measurement conditions. The subject is white ceramics.
- 2) This product complies with 21 CFR 1040.10 and 1040.11 Laser Notice No. 50, dated June 24, 2007, issued by the FDA (Food and Drug Administration).
- 3) This is the size in the measurement center distance. These values were defined by using $1/e^2$ (13.5% approx.) of the center light intensity. Due to leak light outside the specified area, the reflectance around the detecting point may be higher than at the point and this may affect the measurement value.
- 4) When the sensor is used as an ordinary sensor, the communication output (C/Q) provides the same output operation as the control output (DO).

PRECAUTIONS FOR PROPER USE

- This catalog is a guide to select a suitable product. Be sure to read instruction manual attached to the product prior to its use.



- Never use this product as a sensing device for personnel protection.
- In case of using sensing devices for personnel protection, use products which meet laws and standards, such as OSHA, ANSI or IEC etc., for personnel protection applicable in each region or country.



- Do not operate products using methods other than the ones described in the instruction manual included with each product. Control or adjustment through procedures other than the ones specified may cause hazardous laser radiation exposure.



- This product is classified as a Class 2 Laser Product under IEC / JIS / GB standards and FDA* regulations. Do not look at the laser beam directly or through an optical system such as a lens.
- The warning label (English) is attached to the product. Handle the product according to the instruction given on the warning label. (The warning labels in Japanese and Chinese are packed with the sensor.)

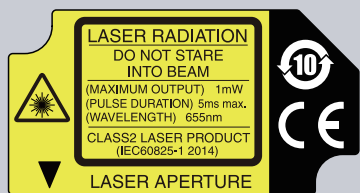

*This product complies with 21 CFR 1040.10 and 1040.11 Laser Notice No. 50, dated June 24, 2007, issued by CDRH (Center for Devices and Radiological Health) under the FDA (Food and Drug Administration).

Mounting

- When mounting this product, use M3 screws. The tightening torque should be 0.5 N·m. Please prepare M3 screws separately.

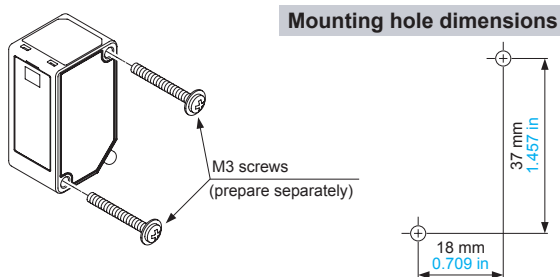

- When mounting the simple mounting bracket (optional) on this product, the tightening torque should be 0.5 N·m or less.

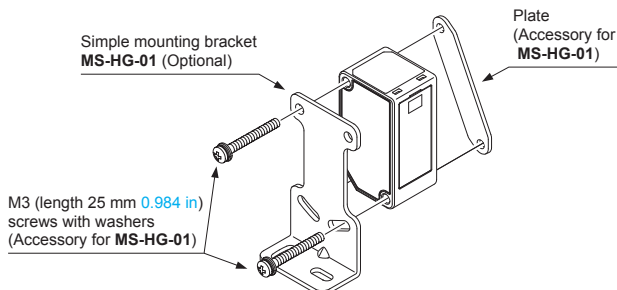

Note: Due to the simple mounting bracket, the sensing characteristics may not be hold depending on the installation condition, in case of the purposes for acquiring the displacement data and a fine detecting.

Mounting direction

- **Direction to a movable body**
<When there are differences in material and color>
 - When performing measurements of moving objects with excessively different materials and colors, mount the product per the following directions to minimize measurement errors.

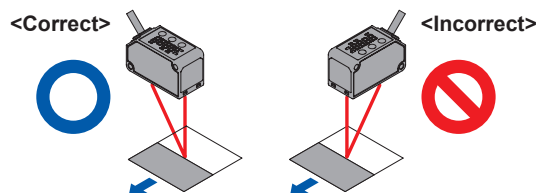

<Measurement of rotating objects>

- When measuring rotating objects, mount the product as follows. Measurement can be performed with minimized effect on the object caused by up / down deflection, position deviation and etc.

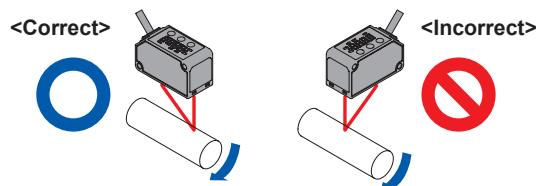

<When there is a step>

- When there is a step in the moving object, mount the product as follows. Measurement can be performed with minimized effect from the edges of the steps.

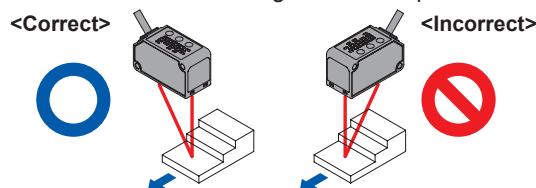

• Measuring of narrow locations and recesses

- When measuring in narrow locations or inside holes, mount the product so that optical path from the light-emitting part to light-receiving part is not interrupted.

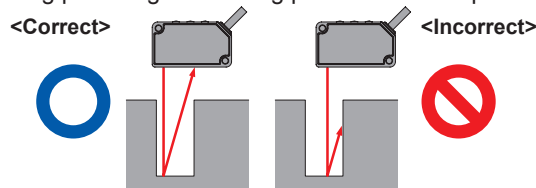

• When mounting the product on a wall

- Mount the product as follows, so that the multiple light reflections on the wall do not emit to the light-receiving part. When the reflection factor on a wall is high, it is effective to use a dull black color.

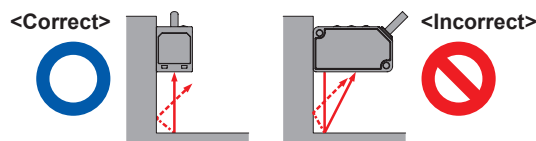

Others

- This product has been developed / produced for industrial use only.
- There is a certain deviation in the directionality of this product. Install the product using a mounting bracket or similar fitting to allow the adjustment of optical axis.
- The internal memory (nonvolatile) of this product has a service life. Settings cannot be configured more than 100,000 times.

DIMENSIONS (Unit: mm in)

The CAD data can be downloaded from the website.

HG-C□L3-P(-J)

Sensor

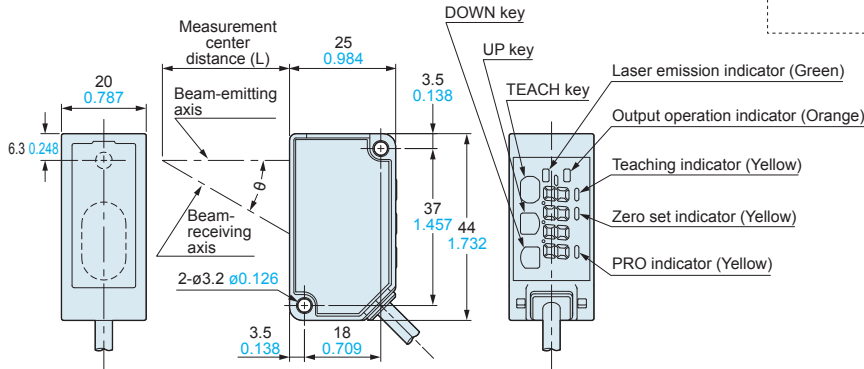
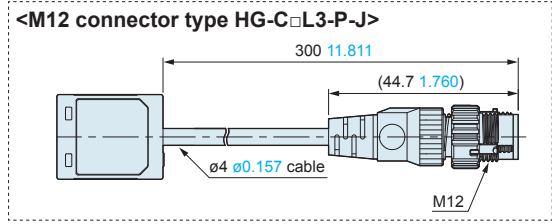
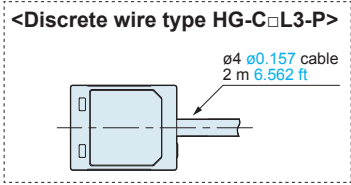

Model No.	Measurement center distance (L)	θ
HG-C1030L3-P(-J)	30 1.181	30°
HG-C1050L3-P(-J)	50 1.969	22.5°
HG-C1100L3-P(-J)	100 3.937	12.5°
HG-C1200L3-P(-J)	200 7.874	6.3°
HG-C1400L3-P(-J)	400 15.748	3.2°

MS-HG-01

Simple mounting bracket (Optional)

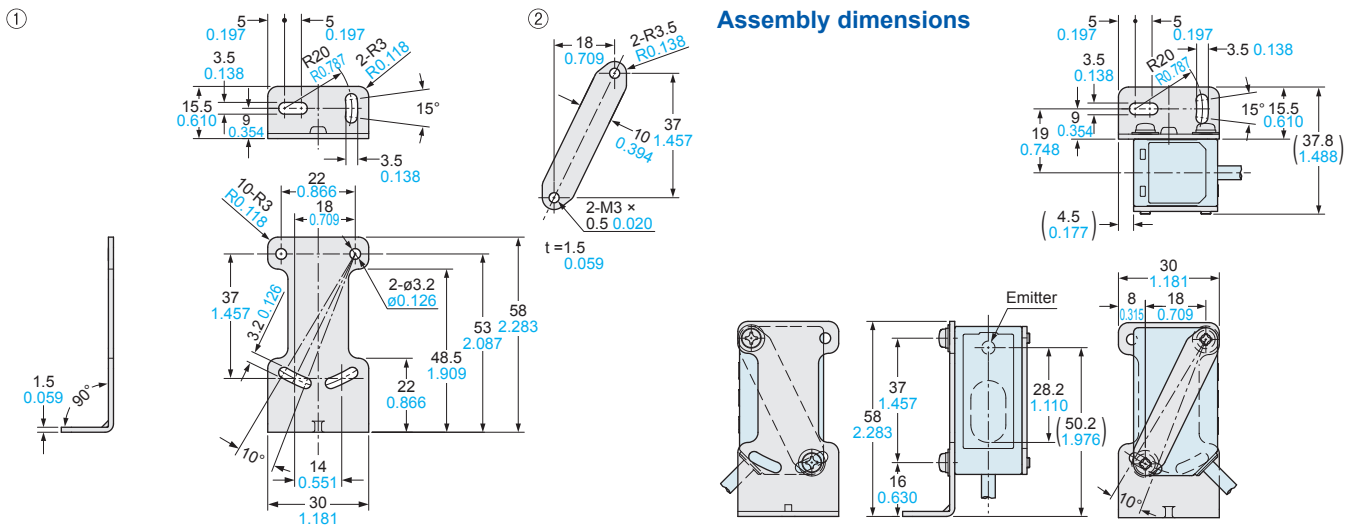

Material: Stainless steel (SUS304)
 Two M3 (length 25 mm 0.984 in) screws with washers [cold rolled carbon steel (SPCC)] are attached.

Disclaimer

The applications described in the catalog are all intended for examples only. The purchase of our products described in the catalog shall not be regarded as granting of a license to use our products in the described applications. We do NOT warrant that we have obtained some intellectual properties, such as patent rights, with respect to such applications, or that the described applications may not infringe any intellectual property rights, such as patent rights, of a third party.

Please contact

Panasonic Corporation

Electromechanical Control Business Division
 ■ 1006, Oaza Kadoma, Kadoma-shi, Osaka 571-8506, Japan
industrial.panasonic.com/ac/e/



X-ON Electronics

Largest Supplier of Electrical and Electronic Components

Click to view similar products for [Industrial Pressure Sensors](#) category:

Click to view products by [Panasonic](#) manufacturer:

Other Similar products are found below :

[75380-05](#) [76053-00000300-01](#) [76053-00000300-05](#) [76061-00000015-01](#) [76062-B00000350-01](#) [76063-00000350-05](#) [76083-05000500-01](#)
[76311-05](#) [76577-00000070-01](#) [77343-24.0H2-01](#) [77343-25.0H2-01](#) [78291-B00000060-01](#) [78303-B00000400-01](#) [78303-B00000400-05](#)
[78316-B00000030-01](#) [78353-B00000020-05](#) [78665-00000014-05](#) [78677-B00000070-05](#) [78678-00000040-01](#) [79279-00000060-01](#) [79296-](#)
[B00000350-01](#) [79322-00250035-01](#) [79614-30.0H2-14](#) [79670-00000090-15](#) [79700-00002750-01](#) [79917-B00000280-01](#) [80569-00700100-01](#)
[81509081](#) [81739-B00000900-01](#) [81807-B00000020-01](#) [MLH010BST01A](#) [MLH010BST14A](#) [MLH025BGC13B](#) [MLH025BSCDJ1292](#)
[MLH025BSCDJ1303](#) [MLH750PSCDJ1245](#) [82903-B00000020-01](#) [83250-02500600-05](#) [83271-00000040-04](#) [83278-B00000200-21](#) [83282-](#)
[00000100-05](#) [83286-00000150-01](#) [83299-00000150-05](#) [83303-00000600-01](#) [83305-00001350-01](#) [83330-00000100-01](#) [83349-00001470-24](#)
[83350-04.0HG-05](#) [83350-15.0H2-05](#) [83357-00000030-21](#)