

Metal Film Thermosensitive Chip Resistors

0402, 0603, 0805

Type: **ERAW, V, S**



■ Features

- Suitable for temperature correction circuits
- Temperature coefficient value 1500 to 3900 $\times 10^{-6}/^{\circ}\text{C}$
- High performance
Quick response to temperature change
- Linearity
Excellent linear resistance value change in wide temperature range (-40°C to $+125^{\circ}\text{C}$)
- High reliability, High density placing
- Small size and lightweight for PWB size reduction and lightweight products
- Suitable for both reflow and flow soldering
- Reference Standards
IEC 60115-8, JIS C 5201-8, EIAJ RC-2145
- RoHS compliant

■ Explanation of Part Numbers

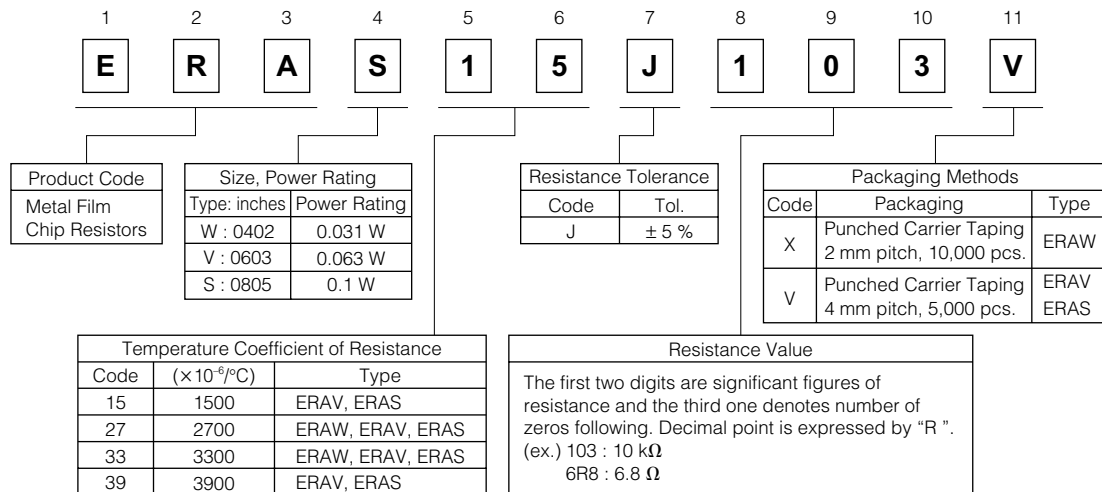

■ Construction

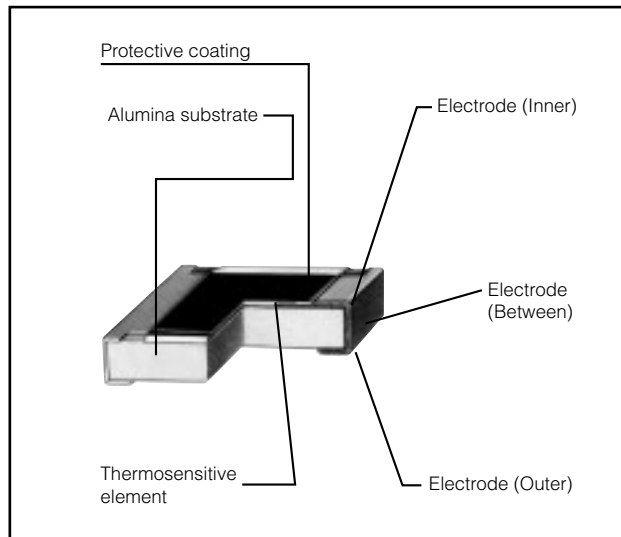

■ Dimensions in mm (not to scale)

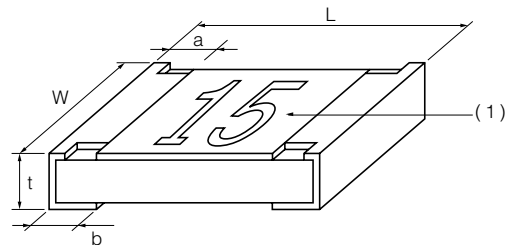

Type (inches)	Dimensions (mm)					Mass (Weight) [g/1000 pcs.]
	L	W	a	b	t	
ERAW (0402)	1.00 $^{+0.07}$	0.50 $^{+0.05}$	0.15 $^{+0.10}$	0.25 $^{+0.07}$	0.35 $^{+0.05}$	0.6
ERAV (0603)	1.60 $^{+0.20}$	0.80 $^{+0.20}$	0.30 $^{+0.20}$	0.30 $^{+0.20}$	0.45 $^{+0.10}$	2
ERAS (0805)	2.00 $^{+0.20}$	1.25 $^{+0.10}$	0.40 $^{+0.25}$	0.40 $^{+0.25}$	0.50 $^{+0.10}$	4

1) Marking Temperature Coefficient value :
2 significant figure $\times 100 \times 10^{-6}/^{\circ}\text{C}$
ERAW type is no marking.

■ Ratings

Type (inched)	Power Rating at 70 °C (W)	Standard Specification ⁽¹⁾		T.C.R. Tolerance	Resistance Tolerance (%)	Standard Resistance Values
		T.C.R. ($\times 10^{-6}/^{\circ}\text{C}$) ⁽²⁾	Resistance Range (Ω)			
ERAW (0402)	0.031	2700 3300	43 to 1 k 22 to 390	$\pm 10\%$	± 5	E12
ERAV (0603)	0.063	1500	10 to 10 k	$\pm 200 \times 10^{-6}/^{\circ}\text{C}$	± 5	E12
		2700 3300 3900	43 to 3.3 k 22 to 1.2 k 7.5 to 390	$\pm 10\%$		
		1500	10 to 10 k	$\pm 200 \times 10^{-6}/^{\circ}\text{C}$		
ERAS (0805)	0.1	2700 3300 3900	43 to 5.1 k 22 to 1.8 k 6.2 to 470	$\pm 10\%$	± 5	E12
		1500	10 to 10 k	$\pm 200 \times 10^{-6}/^{\circ}\text{C}$		
		2700 3300 3900	43 to 5.1 k 22 to 1.8 k 6.2 to 470	$\pm 10\%$		

(1) Please ask us when resistors other than standard specification shown in the above table are needed.

(2) T.C.R. = $\left\{ \frac{R_{75} - R_{25}}{R_{25}} \times \frac{1}{75 - 25} \times 10^6 \right\} \times 10^{-6}/^{\circ}\text{C}$
 R_{25} : Resistance value at reference temperature 25 °C
 R_{75} : Resistance value at temperature 75 °C

Power Derating Curve

For resistors operated in ambient temperatures above 70 °C, power rating shall be derated in accordance with the figure on the right.

Category Temperature Range
 -40 °C to +125 °C

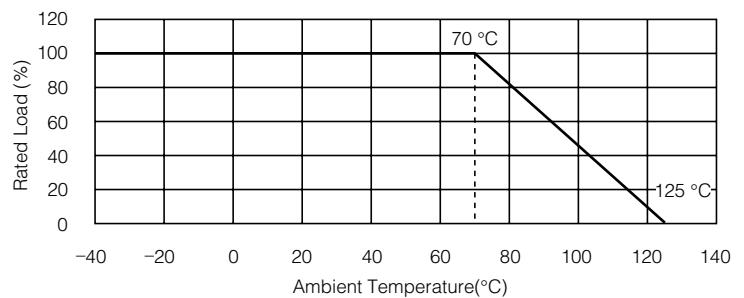

■ Typical Linearity of Resistance Change

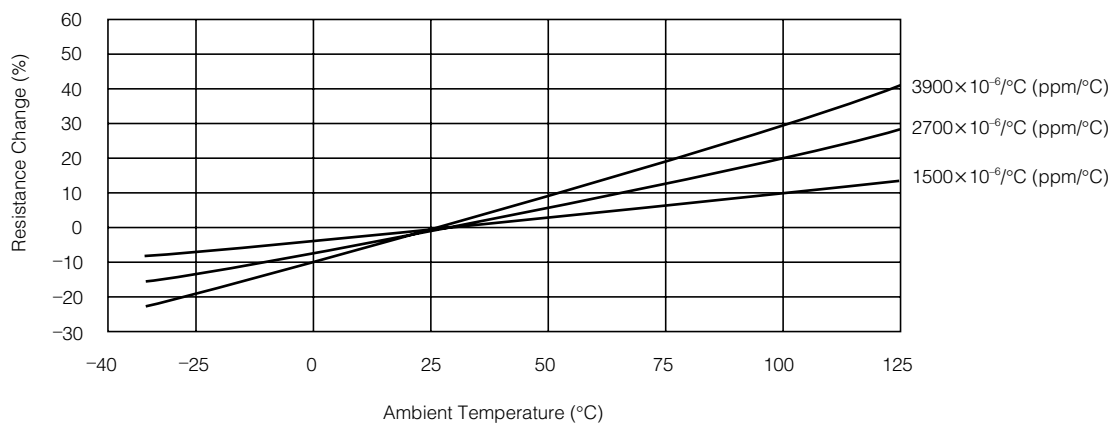

■ Packaging Methods (Taping)

- Standard Quantity

Type	Kind of Taping	Pitch (P ₁)	Quantity
ERAW	Punched Carrier Taping	2 mm	10000 pcs./reel
ERAV		4 mm	5000 pcs./reel
ERAS			

● Carrier Tape

(Unit : mm)

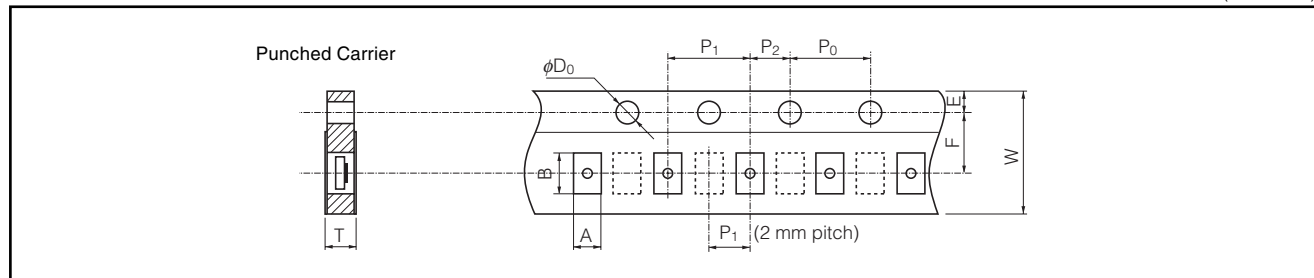

Type	A	B	W	F	E	P ₁	P ₂	P ₀	φD ₀	T
ERAW	0.67 ^{+0.05}	1.17 ^{+0.05}	8.00 ^{+0.20}	3.50 ^{+0.05}	1.75 ^{+0.10}	2.00 ^{+0.10}	2.00 ^{+0.05}	4.00 ^{+0.10}	1.50 ^{+0.10} ₋₀	0.52 ^{+0.05}
ERAV	1.10 ^{+0.10}	1.19 ^{+0.10}				4.00 ^{+0.10}				0.70 ^{+0.05}
ERAS	1.65 ^{+0.15}	2.50 ^{+0.20}				0.84 ^{+0.05}				

● Taping Reel

(Unit : mm)

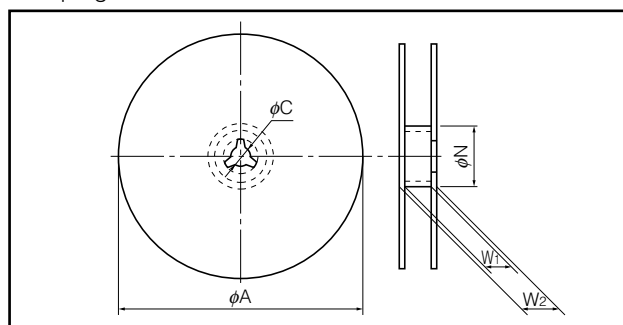

Type	φA	φN	φC	W ₁	W ₂
ERAW	180.0 ⁺⁰ _{-1.5}	60 ^{+1.0} ₋₀	13.0 ^{+0.2}	9.0 ^{+1.0} ₋₀	11.4 ^{+1.0}
ERAV					
ERAS					

■ Attention

This product has high temperature coefficient. When measuring resistance, the resistance value can change due to Joule Heating. Therefore, the measuring current shall be very small in order to prevent the resistance value from changing. (For example, when the resistor is used at RCWV, temperature of the resistor rise about 15 °C and the resistance value rise a few percents.) Resistance value may also change due to the ambient temperature. Resistance value is measured at 25 °C.

■ Recommended Land Pattern

An example of a land pattern to Metal Film Thermosensitive Chip Resistors is shown below.

Example

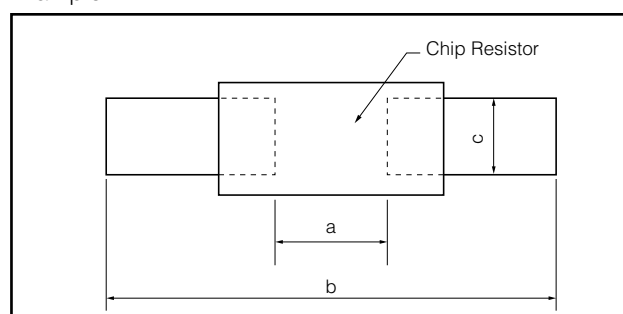

Type (inch size)	Dimensions (mm)		
	a	b	c
ERAW (0402)	0.5 to 0.6	1.4 to 1.6	0.4 to 0.6
ERAV (0603)	0.7 to 0.9	2.0 to 2.2	0.8 to 1.0
ERAS (0805)	1.0 to 1.4	3.2 to 3.8	0.9 to 1.4

Recommended Soldering Conditions

Recommendations and precautions are described below.

- Recommended soldering conditions for reflow
 - Reflow soldering shall be performed a maximum of two times.
 - Please contact us for additional information when used in conditions other than those specified.
 - Please measure the temperature of the terminals and study every kind of solder and printed circuit board for solderability before actual use.

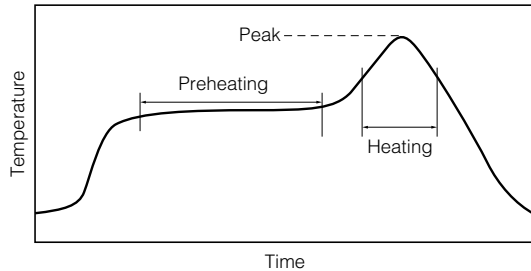

For soldering (Example : Sn/Pb)

	Temperature	Time
Preheating	140 °C to 160 °C	60 s to 120 s
Main heating	Above 200 °C	30 s to 40 s
Peak	235 ± 5 °C	max. 10 s

For lead-free soldering (Example : Sn/Ag/Cu)

	Temperature	Time
Preheating	150 °C to 180 °C	60 s to 120 s
Main heating	Above 230 °C	30 s to 40 s
Peak	max. 260 °C	max. 10 s

- Recommended soldering conditions for flow

	For soldering		For lead-free soldering	
	Temperature	Time	Temperature	Time
Preheating	140 °C to 180 °C	60 s to 120 s	150 °C to 180 °C	60 s to 120 s
Soldering	245 ± 5 °C	20 s to 30 s	max. 260 °C	max. 10 s

⚠ Safety Precautions

The following are precautions for individual products. Please also refer to the precautions common to Fixed Resistors shown on page ER2 of this catalog.

1. Keep the rated power and ambient temperature within the specified derating curve.
 - * When positioning and mounting Metal Film Thermosensitive Chip Resistors (hereafter called the resistors), make allowance for the effect of heat generated through close contact between the resistors and neighboring components and for the temperature rise of adjacent heat-generating components.
2. If a transient load (heavy load in a short time) like a pulse is expected to be applied, check and evaluate the operations of the resistors when installed in your products before use.
 - When applying pulses to the resistors, keep the pulse peak within the rated voltage.
3. Do not use halogen-based or other high-activity flux. Otherwise, the residue may impair the resistors' performance and/or reliability.
4. When soldering with a soldering iron, never touch the resistors' bodies with the tip of the soldering iron. When using a soldering iron with a high temperature tip, finish soldering as quickly as possible (within three seconds at 350 °C max.).
5. As the amount of applied solder becomes larger, the mechanical stress applied to the resistors increases, causing problems such as cracks and faulty characteristics. Avoid applying an excessive amount of solder.
6. When the resistors' protective coatings are chipped, flawed, or removed, the characteristics of the resistors may be impaired. Take special care not to apply mechanical shock during automatic mounting or cause damage during handling of the boards with the resistors mounted.
7. Do not apply shock to the resistors or pinch them with a hard tool (e.g. pliers and tweezers). Otherwise, the resistors' protective coatings and bodies may be chipped, affecting their performance.
8. Avoid excessive bending of printed circuit boards in order to protect the resistors from abnormal stress.
9. Do not immerse the resistors in solvent for a long time. Before using solvent, carefully check the effects of immersion.

⚠ Safety Precautions (Common precautions for Fixed Resistors)

- When using our products, no matter what sort of equipment they might be used for, be sure to make a written agreement on the specifications with us in advance. The design and specifications in this catalog are subject to change without prior notice.
- Do not use the products beyond the specifications described in this catalog.
- This catalog explains the quality and performance of the products as individual components. Before use, check and evaluate their operations when installed in your products.
- Install the following systems for a failsafe design to ensure safety if these products are to be used in equipment where a defect in these products may cause the loss of human life or other significant damage, such as damage to vehicles (automobile, train, vessel), traffic lights, medical equipment, aerospace equipment, electric heating appliances, combustion/gas equipment, rotating equipment, and disaster/crime prevention equipment.
- * Systems equipped with a protection circuit and a protection device
- * Systems equipped with a redundant circuit or other system to prevent an unsafe status in the event of a single fault

(1) Precautions for use

- These products are designed and manufactured for general and standard use in general electronic equipment (e.g. AV equipment, home electric appliances, office equipment, information and communication equipment)
- These products are not intended for use in the following special conditions. Before using the products, carefully check the effects on their quality and performance, and determine whether or not they can be used.
 1. In liquid, such as water, oil, chemicals, or organic solvent
 2. In direct sunlight, outdoors, or in dust
 3. In salty air or air with a high concentration of corrosive gas, such as Cl₂, H₂S, NH₃, SO₂, or NO₂
 4. Electric Static Discharge (ESD) Environment
These components are sensitive to static electricity and can be damaged under static shock (ESD). Please take measures to avoid any of these environments.
Smaller components are more sensitive to ESD environment.
 5. Electromagnetic Environment
Avoid any environment where strong electromagnetic waves exist.
 6. In an environment where these products cause dew condensation
 7. Sealing or coating of these products or a printed circuit board on which these products are mounted, with resin or other materials
- These products generate Joule heat when energized. Carefully position these products so that their heat will not affect the other components.
- Carefully position these products so that their temperatures will not exceed the category temperature range due to the effects of neighboring heat-generating components. Do not mount or place heat-generating components or inflammables, such as vinyl-coated wires, near these products.
- Note that non-cleaning solder, halogen-based highly active flux, or water-soluble flux may deteriorate the performance or reliability of the products.
- Carefully select a flux cleaning agent for use after soldering. An unsuitable agent may deteriorate the performance or reliability. In particular, when using water or a water-soluble cleaning agent, be careful not to leave water residues. Otherwise, the insulation performance may be deteriorated.

(2) Precautions for storage

The performance of these products, including the solderability, is guaranteed for a year from the date of arrival at your company, provided that they remain packed as they were when delivered and stored at a temperature of 5 °C to 35 °C and a relative humidity of 45 % to 85 %.

Even within the above guarantee periods, do not store these products in the following conditions. Otherwise, their electrical performance and/or solderability may be deteriorated, and the packaging materials (e.g. taping materials) may be deformed or deteriorated, resulting in mounting failures.

1. In salty air or in air with a high concentration of corrosive gas, such as Cl₂, H₂S, NH₃, SO₂, or NO₂
2. In direct sunlight

<Package markings>

Package markings include the product number, quantity, and country of origin. In principle, the country of origin should be indicated in English.

X-ON Electronics

Largest Supplier of Electrical and Electronic Components

Click to view similar products for [Thin Film Resistors - SMD category](#):

Click to view products by [Panasonic manufacturer](#):

Other Similar products are found below :

[7-2176089-6](#) [MCW0406MD1001DP500](#) [FCR1206J22R](#) [FCR1206J33R](#) [PNM0402E5001BST1](#) [1-2176090-3](#) [1-2176089-6](#) [ERA-3EEB2742V](#)
[NCSR250F4M50DTRGF](#) [2176089-1](#) [2176090-4](#) [2176091-3](#) [CMB02070X3000GB200](#) [CPA2512Q6R80FS-T10](#) [4-1625868-7](#) [5-1625868-9](#) [5-18022-5](#) [ERA-3EEB2671V](#) [CFR0W4J0220A2P](#) [CPA2512E68R0FS-T10](#) [CPA2512Q4R70FS-T10](#) [8-2176091-9](#) [2-2176091-0](#)
[NCSR150FR003DTRT3F](#) [NTR06B5832CTRF](#) [NCSR200JR002DTRF](#) [RSJ372NL](#) [NRC-S12F4751TRF](#) [8-1625868-1](#) [1-2176092-4](#) [2176091-9](#) [RT1220P-101-M](#) [PLTU0805U1003LST5](#) [PLTU0603U2001LST5](#) [PLTU0805U1001LST5](#) [PLTU0603U4702LST5](#) [4-2176089-0](#) [8-2176091-0](#) [6-2176091-8](#) [3-2176090-3](#) [1-2176092-7](#) [7-2176092-6](#) [7-2176088-7](#) [PCNM2512E1502BST5](#) [2-2176094-5](#) [PCNM2512E3012BST5](#) [4-2176092-6](#) [3-2176091-4](#) [8-2176091-5](#) [7-2176089-5](#)