

Fixed Resistors

Products Catalog



Guidelines and precautions regarding the technical information and use of our products described in this online catalog.

- If you want to use our products described in this online catalog for applications requiring special qualities or reliability, or for applications where the failure or malfunction of the products may directly jeopardize human life or potentially cause personal injury (e.g. aircraft and aerospace equipment, traffic and transportation equipment, combustion equipment, medical equipment, accident prevention, anti-crime equipment, and/or safety equipment), it is necessary to verify whether the specifications of our products fit to such applications. Please ensure that you will ask and check with our inquiry desk as to whether the specifications of our products fit to such applications use before you use our products.
- The quality and performance of our products as described in this online catalog only apply to our products when used in isolation. Therefore, please ensure you evaluate and verify our products under the specific circumstances in which our products are assembled in your own products and in which our products will actually be used.
- If you use our products in equipment that requires a high degree of reliability, regardless of the application, it is recommended that you set up protection circuits and redundancy circuits in order to ensure safety of your equipment.
- The products and product specifications described in this online catalog are subject to change for improvement without prior notice. Therefore, please be sure to request and confirm the latest product specifications which explain the specifications of our products in detail, before you finalize the design of your applications, purchase, or use our products.
- The technical information in this online catalog provides examples of our products' typical operations and application circuits. We do not guarantee the non-infringement of third party's intellectual property rights and we do not grant any license, right, or interest in our intellectual property.
- If any of our products, product specifications and/or technical information in this online catalog is to be exported or provided to non-residents, the laws and regulations of the exporting country, especially with regard to security and export control, shall be observed.

<Regarding the Certificate of Compliance with the EU RoHS Directive/REACH Regulations>

- The switchover date for compliance with the RoHS Directive/REACH Regulations varies depending on the part number or series of our products.
- When you use the inventory of our products for which it is unclear whether those products are compliant with the RoHS Directive/REACH Regulation, please select "Sales Inquiry" in the website inquiry form and contact us.

We do not take any responsibility for the use of our products outside the scope of the specifications, descriptions, guidelines and precautions described in this online catalog.

Fixed Resistors (Surface Mount Resistors) CONTENTS

Classification	Product Item	Part No.	Page
Safety Precautions (Common precautions for Fixed Resistors / Common precautions for Surface Mount Resistors)			1
General Purpose Chip Resistors	Thick Film Chip Resistors	ERJ XG, 1G, 2G, 3G, 6G, 8G, 14, 12, 12Z, 1T	4
	Precision Thick Film Chip Resistors	ERJ XG, 1G, 1R, 2R, 3R, 6R, 3E, 6E, 8E, ERJ 14, 12, 1T	7
High Precision	Thin Film Chip Resistors, High Stability and Reliability Type	ERA 2V, 3V, 3K, 6V, 6K	11
	Metal Film (Thin Film) Chip Resistors, High Reliability Type	ERA 1A, 2A, 3A, 6A, 8A	14
	High Precision Thick Film Chip Resistors	ERJ PB3, PB6	17
Current Sensing	Thick Film Chip Resistors / Low Resistance Type	ERJ 2LW, 3LW, 6LW, ERJ 2BW,3BW,6BW,8BW,6CW,8CW ERJ 2B, 3B, 6D, 6B, 8B, 14B, 3R, 6R, 8R, 14R, ERJ 12R, 12Z, ERJ 1TR, L03, L06, L08, L14, L12, L1D, L1W	19
	Current Sensing Resistors, Metal Plate Type	ERJ MS4S, MS4H, MB1S	25
	High Power Chip Resistors / Wide Terminal Type	ERJ A1, B1, B2, B3	29
	Low TCR High Power Chip Resistors / Wide Terminal Type	ERJ D1, D2	33
Small&High Power	Anti-Surge Thick Film Chip Resistors	ERJ PA2, P03, PA3, P06, P08, P14	36
	Anti-Pulse Thick Film Chip Resistors	ERJ T06, T08, T14	40
Anti-Sulfurated	Anti-Sulfurated Thick Film Chip Resistors	ERJ S02, S03, S06, S08, S14, S12, S1D, S1T, ERJ U0X, U01, U02, U03, U06, U08, U14, U12, ERJ U1D, ERJ U1T, ERJ U6S, U6Q	43
	Anti-Sulfurated Thick Film Chip Resistors / Precision Type	ERJ U2R, U3R, U6R	47
	Anti-Sulfurated Thick Film Chip Resistors / Anti-Surge Type	ERJ UP3, UP6, UP8	49
	Anti-Sulfurated Thick Film Chip Resistors / Wide Terminal Type	ERJ C1	52
Resistor Network/Array	Chip Resistor Array	EXB 14V, 18V, 24V, 28V, N8V, 2HV, 34V, V4V, 38V, V8V, S8V	55
	Anti-Sulfurated Chip Resistor Array	EXB U14, U18, U24, U28, U2H, U34, U38	59
	Chip Resistor Networks	EXB D, E, A, Q	62
	Chip Attenuator	EXB 14AT, 24AT	66
Common specifications	Packaging Methods (Taping)		68
	Recommended Land Pattern		73
	Recommended Soldering Conditions		76
	Standard for Resistance Value and Resistance Tolerance		77

Safety Precautions (Common precautions for Fixed Resistors)

- When using our products, no matter what sort of equipment they might be used for, be sure to make a written agreement on the specifications with us in advance. The design and specifications in this catalog are subject to change without prior notice.
- Do not use the products beyond the specifications described in this catalog.
- This catalog explains the quality and performance of the products as individual components. Before use, check and evaluate their operations when installed in your products under the actual conditions for use.
- Install the following systems for a failsafe design to ensure safety if these products are to be used in equipment where a defect in these products may cause the loss of human life or other significant damage, such as damage to vehicles (automobile, train, vessel), traffic lights, medical equipment, aerospace equipment, electric heating appliances, combustion/gas equipment, rotating equipment, and disaster/crime prevention equipment.
 - * Systems equipped with a protection circuit and a protection device.
 - * Systems equipped with a redundant circuit or other system to prevent an unsafe status in the event of a single fault.
 - * Systems equipped with an arresting the spread of fire or preventing glitch.

(1) Precautions for use

- These products are designed and manufactured for general and standard use in general electronic equipment (e.g. AV equipment, home electric appliances, office equipment, information and communication equipment). For applications in which special quality and reliability are required, or if the failure or malfunction of the products may directly jeopardize life or cause threat of personal injury (such as for aircraft and aerospace equipment, traffic and transport equipment, combustion equipment, medical equipment, accident prevention and anti-theft devices, and safety equipment), please be sure to consult with our sales representative in advance and to exchange product specifications which conform to such applications.
- These products are not intended for use in the following special conditions. Before using the products, carefully check the effects on their quality and performance, and determine whether or not they can be used.
 1. In liquid, such as water, oil, chemicals, or organic solvent.
 2. In direct sunlight, outdoors, or in dust.
 3. In salty air or air with a high concentration of corrosive gas, such as Cl_2 , H_2S , NH_3 , SO_2 , or NO_x .
 4. Electric Static Discharge (ESD) Environment.

These components are sensitive to static electricity and can be damaged under static shock (ESD). Please take measures to avoid any of these environments.
Smaller components are more sensitive to ESD environment.
 5. Electromagnetic and Radioactive Environment.

Avoid any environment where strong electromagnetic waves and radiation exist.
 6. In an environment where these products cause dew condensation.
 7. Sealing or coating of these products or a printed circuit board on which these products are mounted, with resin or other materials.
- These products generate Joule heat when energized. Carefully position these products so that their heat will not affect the other components.
- Carefully position these products so that their temperatures will not exceed the category temperature range due to the effects of neighboring heat-generating components. Do not mount or place heat-generating components or inflammables, such as vinyl-coated wires, near these products.
- Note that non-cleaning solder, halogen-based highly active flux, or water-soluble flux may deteriorate the performance or reliability of the products.
- Carefully select a flux cleaning agent for use after soldering. An unsuitable agent may deteriorate the performance or reliability. In particular, when using water or a water-soluble cleaning agent, be careful not to leave water residues. Otherwise, the insulation performance may be deteriorated.
- Do not apply flux to these products after soldering. The activity of flux may be a cause of failures in these products.
- Refer to the recommended soldering conditions and set the soldering condition. High peak temperature or long heating time may impair the performance or the reliability of these products.
- Recommended soldering condition is for the guideline for ensuring the basic characteristics of the products, not for the stable soldering conditions. Conditions for proper soldering should be set up according to individual conditions.

- Do not reuse any products after removal from mounting boards.
- Do not drop these products. If these products are dropped, do not use them. Such products may have received mechanical or electrical damage.
- If any doubt or concern to the safety on these products arise, make sure to inform us immediately and conduct technical examinations at your side.

(2) Precautions for storage

The performance of these products, including the solderability, is guaranteed for a year from the date of arrival at your company, provided that they remain packed as they were when delivered and stored at a temperature of 5 °C to 35 °C and a relative humidity of 45 % to 85 %.

Even within the above guarantee periods, do not store these products in the following conditions. Otherwise, their electrical performance and/or solderability may be deteriorated, and the packaging materials (e.g. taping materials) may be deformed or deteriorated, resulting in mounting failures.

1. In salty air or in air with a high concentration of corrosive gas, such as Cl₂, H₂S, NH₃, SO₂, or NO_x.
2. In direct sunlight.

(3) AEC-Q200 Compliant

The products are tested based on all or part of the test conditions and methods defined in AEC-Q200.

Please consult with Panasonic for the details of the product specification and specific evaluation test results, etc., and please review and approve Panasonic's product specification before ordering.

<Package markings>

Package markings include the product number, quantity, and country of origin.

In principle, the country of origin should be indicated in English.

Safety Precautions (Common precautions for Surface Mount Resistors)

The following are precautions for individual products. Please also refer to the common precautions for Fixed Resistors in this catalog.

1. Take measures against mechanical stress during and after mounting of Surface Mount Resistors (hereafter called the resistors) so as not to damage their electrodes and protective coatings. Be careful not to misplace the resistors on the land patterns. Otherwise, solder bridging may occur.
2. Keep the rated power and ambient temperature within the specified derating curve. Some circuit boards, wiring patterns, temperatures of heat generated by adjacent components, or ambient temperatures can become factors in the rise of the temperature of the resistors, regardless of the level of power applied. Therefore, check the conditions before use and optimize them so as not to damage the boards and peripheral components. Make sure to contact us before using the resistors under special conditions.
3. If a transient load (heavy load in a short time) like a pulse is expected to be applied, check and evaluate the operations of the resistors when installed in your products before use. Never exceed the rated power. Otherwise, the performance and/or reliability of the resistors may be impaired.
4. Transient voltage
If there is a possibility that the transient phenomenon (significantly high voltage applied in a short time) may occur or that a high voltage pulse may be applied, make sure to evaluate and check the characteristics of resistors mounted on your product rather than only depending on the calculated power limit or steady-state conditions.
5. If the resistors are to be used in high frequency circuits, carefully check the operation before use. Such circuits change the electrical characteristics of the resistors.
6. Before using halogen-based or other high-activity flux, check the possible effects of the flux residues on the performance and reliability of the resistors.
7. When soldering with a soldering iron, never touch the resistors' bodies with the tip of the soldering iron. When using a soldering iron with a high temperature tip, finish soldering as quickly as possible (within three seconds at 350 °C max.).
8. Mounting of the resistors with excessive or insufficient wetting amount of solder may affect the connection reliability or the performance of the resistors. Carefully check the effects and apply a proper amount of solder for use.
9. When the resistors' protective coatings are chipped, flawed, or removed, the characteristics of the resistors may be impaired. Take special care not to apply mechanical shock during automatic mounting or cause damage during handling of the boards with the resistors mounted.
10. Do not apply shock to the resistors or pinch them with a hard tool (e.g. pliers and tweezers). Otherwise, the resistors' protective coatings and bodies may be chipped, affecting their performance.
11. Avoid excessive bending of printed circuit boards in order to protect the resistors from abnormal stress.
12. Do not immerse the resistors in solvent for a long time. Before using solvent, carefully check the effects of immersion.
13. Do not apply excessive tension to the terminals.

Thick Film Chip Resistors

Series: ERJ XG, 1G, 2G, 3G, 6G,
8G, 14, 12, 12Z, 1T

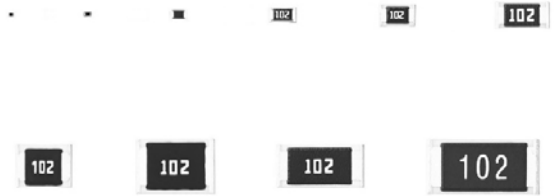

Features

- Small size and lightweight
- High reliability...Metal glaze thick film resistive element and three layers of electrodes
- Compatible with placement machines ... Taping packaging available
- Suitable for both reflow and flow soldering
- Reference Standard ... IEC 60115-8, JIS C 5201-8, JEITA RC-2134C
- AEC-Q200 compliant (except ERJXG)
- RoHS compliant

■ **As for Packaging Methods, Land Pattern, Soldering Conditions and Safety Precautions,**
Please see Data Files

Explanation of Part Numbers

- Series ERJXGN, 1GN, 2GE, 3GE, 6GE, 8GE, 14, 12, 12Z, 1T, ±5 %

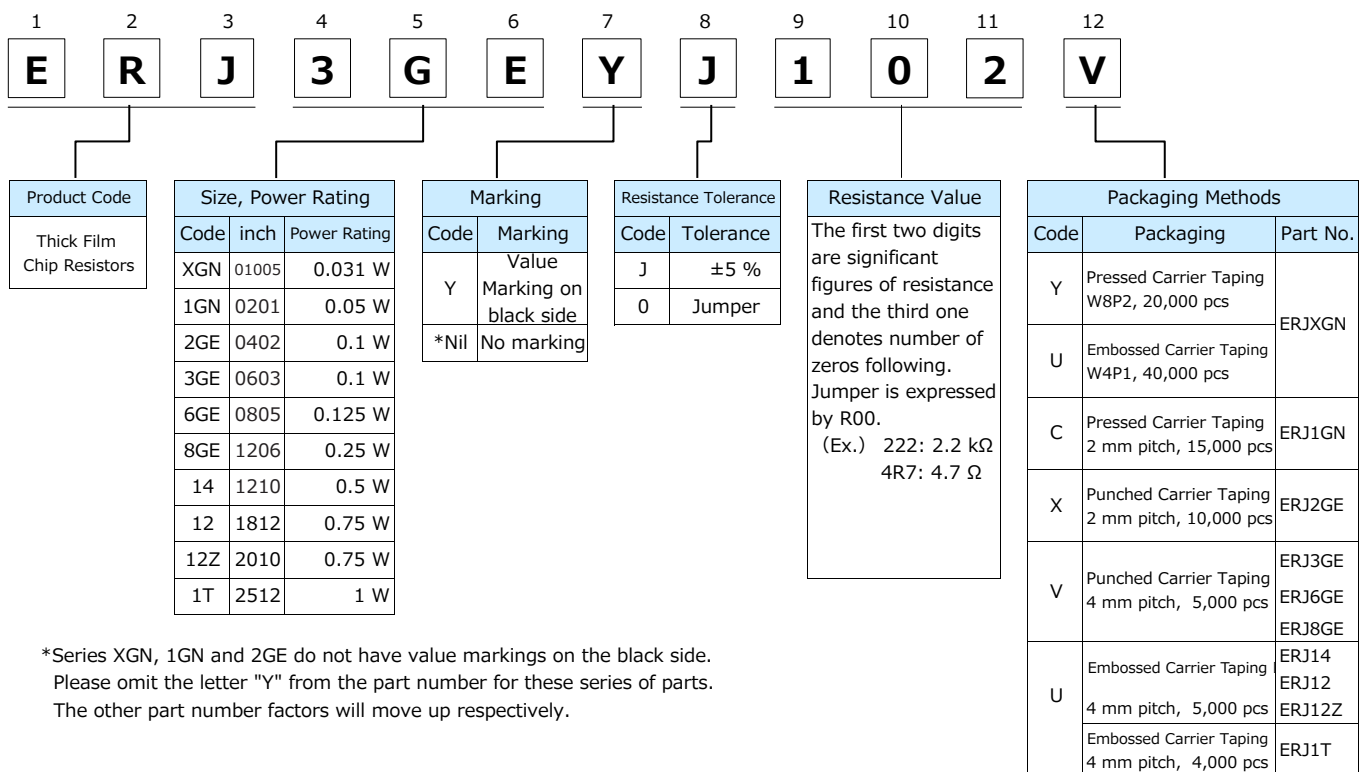

*Series XGN, 1GN and 2GE do not have value markings on the black side. Please omit the letter "Y" from the part number for these series of parts. The other part number factors will move up respectively.

Ratings

[For Resistor]

Part No. (inch size)	Power Rating at 70 °C ⁽¹⁾ (W)	Limiting Element Voltage ⁽²⁾ (V)	Maximum Overload Voltage ⁽³⁾ (V)	Resistance Tolerance (%)	Resistance Range (Ω)	T.C.R. (×10 ⁻⁶ /K)	Category Temperature Range (°C)	AEC- Q200 Grade
ERJXG (01005)	0.031	15	30	±5	1 to 1 M (E24)	R<10 Ω : -100 to +600 10 Ω to 100 Ω : ±300 100 Ω≤R : ±200	-55 to +125	-
ERJ1G (0201)	0.05	25	50	±5	1 to 10 M (E24)	R<10 Ω : -100 to +600 10 Ω to 1 M Ω : ±200 1 MΩ<R : -400 to +150	-55 to +125	Grade 1
ERJ2G (0402)	0.1	50	100	±5	1 to 10 M (E24)		-55 to +155	Grade 0
ERJ3G (0603)	0.1	75	150	±5	1 to 10 M (E24)		-55 to +155	Grade 0
ERJ6G (0805)	0.125	150	200	±5	1 to 10 M (E24)		-55 to +155	Grade 0
ERJ8G (1206)	0.25	200	400	±5	1 to 10 M (E24)		-55 to +155	Grade 0
ERJ14 (1210)	0.5	200	400	±5	1 to 10 M (E24)		-55 to +155	Grade 0
ERJ12 (1812)	0.75	200	500	±5	1 to 10 M (E24)		-55 to +155	Grade 0
ERJ12Z (2010)	0.75	200	500	±5	1 to 10 M (E24)		-55 to +155	Grade 0
ERJ1T (2512)	1	200	500	±5	1 to 1 M (E24)		-55 to +155	Grade 0

- (1) Use it on the condition that the case temperature is below the upper category temperature.
- (2) Rated Continuous Working Voltage (RCWV) shall be determined from $RCWV = \sqrt{\text{Power Rating} \times \text{Resistance Value}}$, or Limiting Element Voltage listed above, whichever less.
- (3) Overload Test Voltage (OTV) shall be determined from $OTV = \text{Specified Magnification (refer to performance)} \times RCWV$ or Maximum Overload Voltage listed above, whichever less.

[For Jumper]

Part No.	Resistance(Ω)	Rated Current(A)	Maximum Overload Current (A) ⁽¹⁾
ERJXG	50 mΩ or less	0.5	1
ERJ1G			
ERJ2G			
ERJ3G		1	2
ERJ6G			
ERJ8G			
ERJ14		2	4
ERJ12			
ERJ12Z			
ERJ1T			

(1) Overload test current

Power Derating Curve

For resistors operated in ambient temperatures above 70 °C, power rating shall be derated in accordance with the figure below.

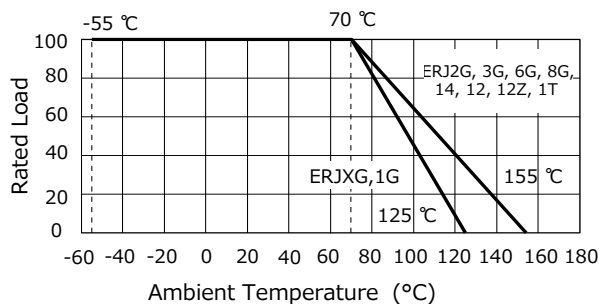

Construction

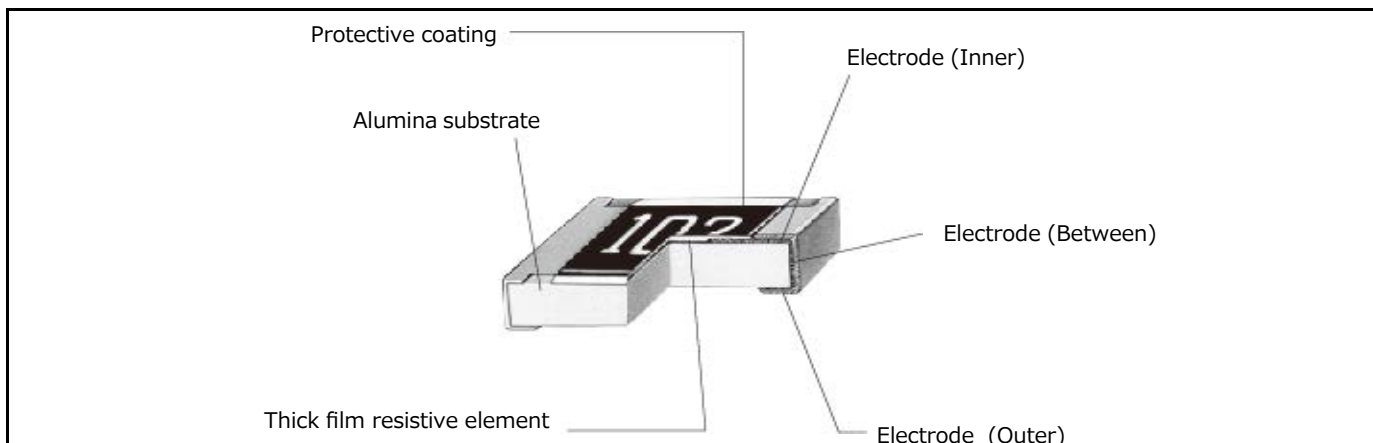

Dimensions in mm (not to scale)

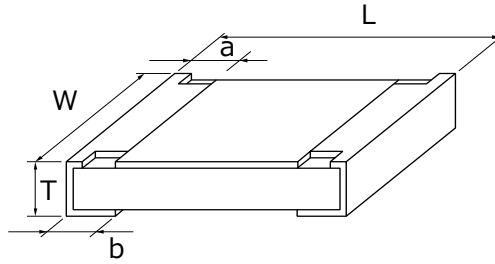

Part No.	Dimensions (mm)					Mass (Weight) (g/1000 pcs)
	L	W	a	b	T	
ERJXG	0.40±0.02	0.20±0.02	0.10±0.03	0.10±0.03	0.13±0.02	0.04
ERJ1G	0.60±0.03	0.30±0.03	0.10±0.05	0.15±0.05	0.23±0.03	0.15
ERJ2G	1.00±0.05	0.50±0.05	0.20±0.10	0.25±0.05	0.35±0.05	0.8
ERJ3G	1.60±0.15	0.80+0.15/-0.05	0.30±0.20	0.30±0.15	0.45±0.10	2
ERJ6G	2.00±0.20	1.25±0.10	0.40±0.20	0.40±0.20	0.60±0.10	4
ERJ8G	3.20+0.05/-0.20	1.60+0.05/-0.15	0.50±0.20	0.50±0.20	0.60±0.10	10
ERJ14	3.20±0.20	2.50±0.20	0.50±0.20	0.50±0.20	0.60±0.10	16
ERJ12	4.50±0.20	3.20±0.20	0.50±0.20	0.50±0.20	0.60±0.10	27
ERJ12Z	5.00±0.20	2.50±0.20	0.60±0.20	0.60±0.20	0.60±0.10	27
ERJ1T	6.40±0.20	3.20±0.20	0.65±0.20	0.60±0.20	0.60±0.10	45

Performance

Test Item	Performance Requirements ΔR		Test Conditions
	Resistor type	Jumper type	
Resistance	Within Specified Tolerance	50 m Ω or less	20 °C
T. C. R.	Within Specified T. C. R.	50 m Ω or less	+25 °C/+155 °C (ERJXG,1G : +25 °C/+125 °C)
Overload	±2 %	50 m Ω or less	Rated Voltage× 2.5, 5 s Jumper type : Max. Overload Current, 5 s
Resistance to Soldering Heat	±1 %	50 m Ω or less	270 °C, 10 s
Rapid Change of Temperature	±1 %	50 m Ω or less	-55 °C (30 min.) / +155 °C (ERJXG,1G : +125 °C) (30 min.), 100 cycles
High Temperature Exposure	±1 %	50 m Ω or less	+155 °C (ERJXG,1G : +125 °C), 1000 h
Damp Heat, Steady State	±1 %	50 m Ω or less	60 °C, 90 % to 95 %RH, 1000 h
Load Life in Humidity	±3 %	50 m Ω or less	60 °C, 90 % to 95 %RH, Rated Voltage (Jumper type : Rated Current), 1.5 h ON / 0.5 h OFF cycle, 1000 h
Endurance at 70 °C	±3 %	50 m Ω or less	70 °C, Rated Voltage (Jumper type : Rated Current), 1.5 h ON / 0.5 h OFF cycle, 1000 h

Precision Thick Film Chip Resistors



Series: **ERJ XG, 1G**
ERJ 1R, 2R, 3R, 6R
ERJ 3E, 6E, 8E, 14, 12, 1T



Features

- Small size and lightweight
- High reliability...Metal glaze thick film resistive element and three layers of electrodes
- Compatible with placement machines ... Taping packaging available
- Suitable for both reflow and flow soldering
- Low Resistance Tolerance :ERJXG, 1G, 2R, 3E, 6E, 8E, 14, 12, 1T : ±1 %
ERJ1R, 2R, 3R, 6R : ±0.5 %
- Reference Standard ... IEC 60115-8, JIS C 5201-8, JEITA RC-2134C
- AEC-Q200 compliant (except ERJXG, ERJ1R)
- RoHS compliant

■ **As for Packaging Methods, Land Pattern, Soldering Conditions and Safety Precautions,**
Please see Data Files

Explanation of Part Numbers

- Series ERJ1R, 2R, 3R, 6R, ±0.5 %

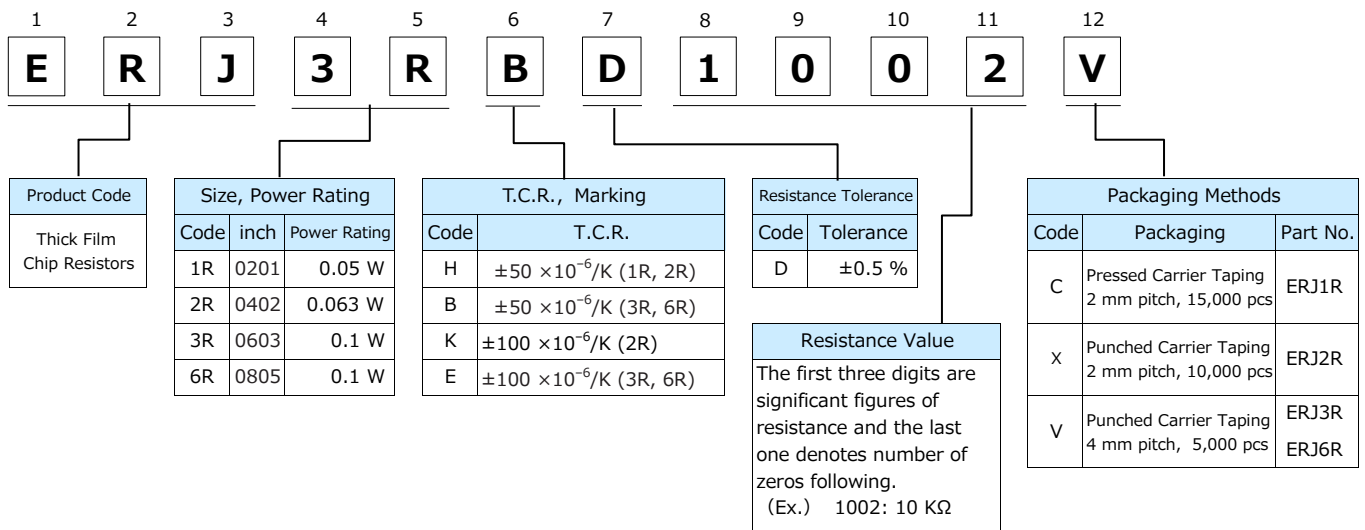

- Series ERJXGN, 1GN, 2RC, 2RK, 3EK, 6EN, 8EN, 14N, 12N, 12S, 1TN, ±1 %

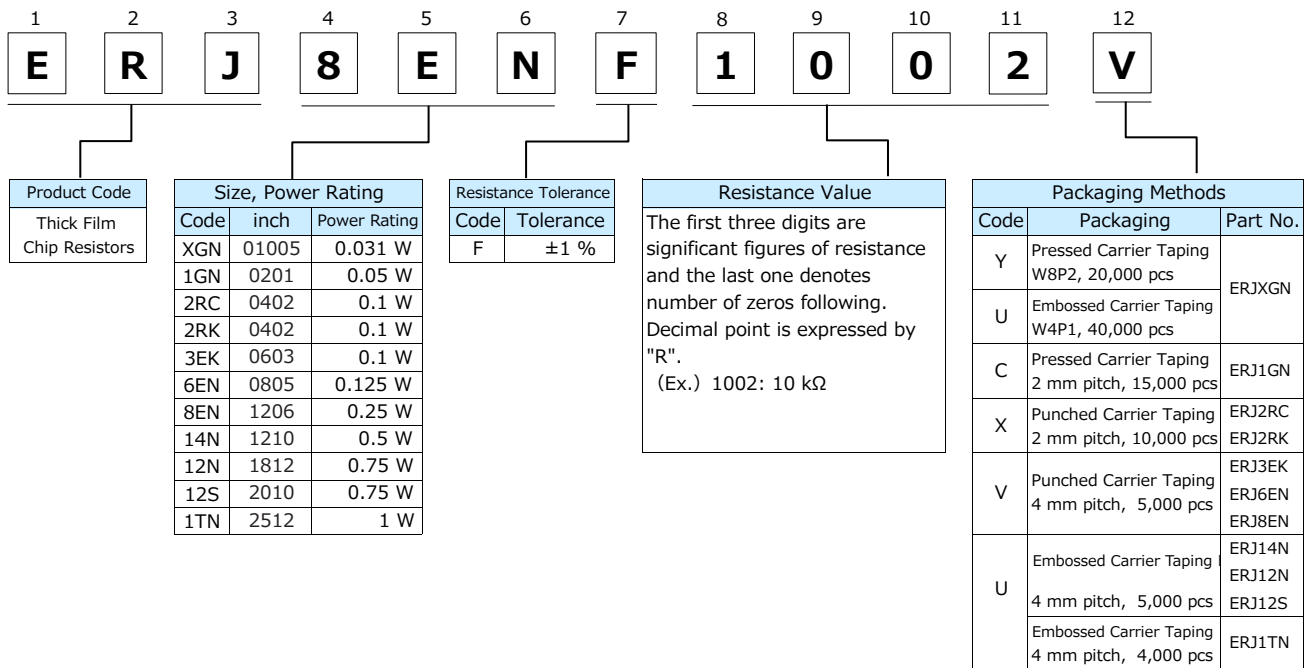

Ratings

<±0.5 %>

Part No. (inch size)	Power Rating at 70 °C ⁽¹⁾ (W)	Limiting Element Voltage ⁽²⁾ (V)	Maximum Overload Voltage ⁽³⁾ (V)	Resistance Tolerance (%)	Resistance Range (Ω)	T.C.R. (×10 ⁻⁶ /K)	Category Temperature Range (°C)	AEC- Q200 Grade
ERJ1RH (0201)	0.05	15	30	±0.5	1 k to 1 M (E24,E96)	±50	-55 to +125	-
ERJ2RH (0402)	0.063	50	100	±0.5	100 to 100 k (E24,E96)	±50	-55 to +155	Grade 0
ERJ2RK (0402)	0.063	50	100	±0.5	10 to 97.6 102 k to 1 M (E24,E96)	±100	-55 to +155	Grade 0
ERJ3RB (0603)	0.1	50	100	±0.5	100 to 100 k (E24,E96)	±50	-55 to +155	Grade 0
ERJ3RE (0603)	0.1	50	100	±0.5	10 to 97.6 102 k to 1 M (E24,E96)	±100	-55 to +155	Grade 0
ERJ6RB (0805)	0.1	150	200	±0.5	100 to 100 k (E24,E96)	±50	-55 to +155	Grade 0
ERJ6RE (0805)	0.1	150	200	±0.5	10 to 97.6 102 k to 1 M (E24,E96)	±100	-55 to +155	Grade 0

- (1) Use it on the condition that the case temperature is below the upper category temperature.
- (2) Rated Continuous Working Voltage (RCWV) shall be determined from $RCWV = \sqrt{\text{Power Rating} \times \text{Resistance Value}}$, or Limiting Element Voltage listed above, whichever less.
- (3) Overload Test Voltage (OTV) shall be determined from $OTV = \text{Specified Magnification (refer to performance)} \times RCWV$ or Maximum Overload Voltage listed above, whichever less.

Ratings

<±1 %>

Part No. (inch size)	Power Rating at 70 °C ⁽¹⁾ (W)	Limiting Element Voltage ⁽²⁾ (V)	Maximum Overload Voltage ⁽³⁾ (V)	Resistance Tolerance (%)	Resistance Range (Ω)	T.C.R. (×10 ⁻⁶ /K)	Category Temperature Range (°C)	AEC- Q200 Grade
ERJXGN (01005)	0.031	15	30	±1	10 to 1 M ⁽⁴⁾ (E24,E96)	R<100 Ω : ±300 100 Ω ≤R : ±200	-55 to +125	-
ERJ1GN (0201)	0.05	25	50	±1	10 to 1 M ⁽⁴⁾ (E24,E96)	±200	-55 to +125	Grade 1
ERJ2RC (0402)	0.1	50	100	±1	1 to 9.76 (E24,E96)	-100 to +600	-55 to +155	Grade 0
ERJ2RK (0402)	0.1	50	100	±1	10 to 1 M (E24,E96)	±100	-55 to +155	Grade 0
ERJ3EK (0603)	0.1	75	150	±1	10 to 1 M (E24,E96)	±100	-55 to +155	Grade 0
ERJ6EN (0805)	0.125	150	200	±1	10 to 2.2 M (E24,E96)	±100	-55 to +155	Grade 0
ERJ8EN (1206)	0.25	200	400	±1	10 to 2.2 M (E24,E96)	±100	-55 to +155	Grade 0
ERJ14N (1210)	0.5	200	400	±1	10 to 1 M (E24,E96)	±100	-55 to +155	Grade 0
ERJ12N (1812)	0.75	200	500	±1	10 to 1 M (E24,E96)	±100	-55 to +155	Grade 0
ERJ12S (2010)	0.75	200	500	±1	10 to 1 M (E24,E96)	±100	-55 to +155	Grade 0
ERJ1TN (2512)	1	200	500	±1	10 to 1 M (E24,E96)	±100	-55 to +155	Grade 0

(1) Use it on the condition that the case temperature is below the upper category temperature.

(2) Rated Continuous Working Voltage (RCWV) shall be determined from $RCWV = \sqrt{\text{Power Rating} \times \text{Resistance Value}}$, or Limiting Element Voltage listed above, whichever less.

(3) Overload Test Voltage (OTV) shall be determined from $OTV = \text{Specified Magnification (refer to performance)} \times RCWV$ or Maximum Overload Voltage listed above, whichever less.

(4) Please contact us when you need a type with a resistance of less than 10 Ω.

Power Derating Curve

For resistors operated in ambient temperatures above 70 °C, power rating shall be derated in accordance with the figure on the right.

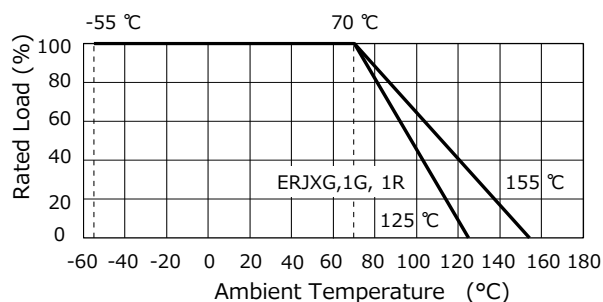

Construction

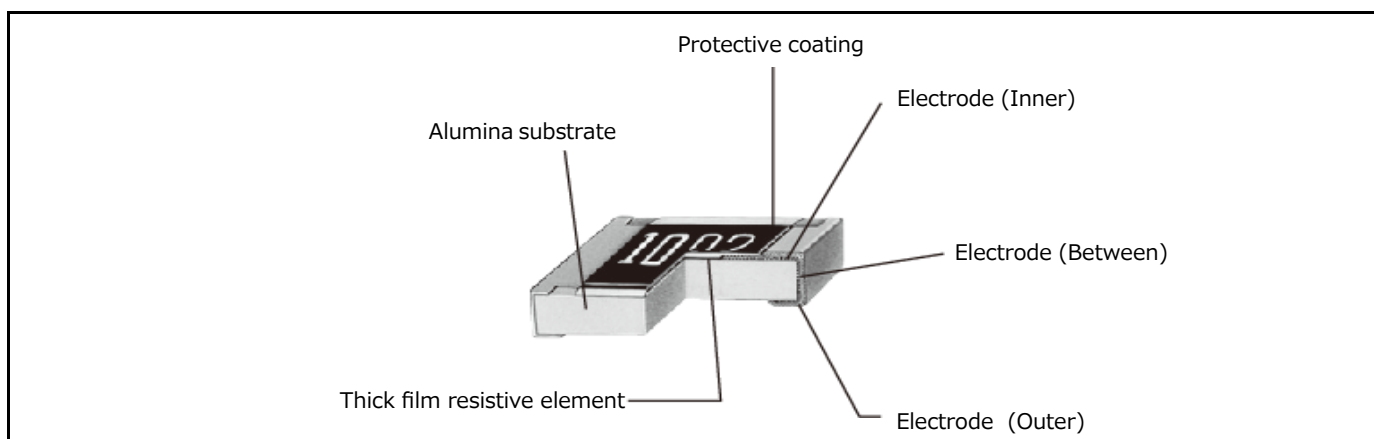

Dimensions in mm (not to scale)

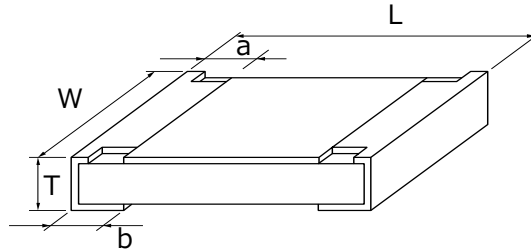

Part No.	Dimensions (mm)					Mass (Weight) (g/1000 pcs)
	L	W	a	b	T	
ERJXGN	0.40±0.02	0.20±0.02	0.10±0.03	0.10±0.03	0.13±0.02	0.04
ERJ1GN ERJ1R□	0.60±0.03	0.30±0.03	0.10±0.05	0.15±0.05	0.23±0.03	0.15
ERJ2R□	1.00±0.05	0.50±0.05	0.20±0.10	0.25±0.05	0.35±0.05	0.8
ERJ3R□ ERJ3EK	1.60±0.15	0.80+0.15/-0.05	0.30±0.20	0.30±0.15	0.45±0.10	2
ERJ6R□ ERJ6EN	2.00±0.20	1.25±0.10	0.40±0.20	0.40±0.20	0.60±0.10	4
ERJ8EN	3.20+0.05/-0.20	1.60+0.05/-0.15	0.50±0.20	0.50±0.20	0.60±0.10	10
ERJ14N	3.20±0.20	2.50±0.20	0.50±0.20	0.50±0.20	0.60±0.10	16
ERJ12N	4.50±0.20	3.20±0.20	0.50±0.20	0.50±0.20	0.60±0.10	27
ERJ12S	5.00±0.20	2.50±0.20	0.60±0.20	0.60±0.20	0.60±0.10	27
ERJ1TN	6.40±0.20	3.20±0.20	0.65±0.20	0.60±0.20	0.60±0.10	45

Performance

● Series ERJ1R, 2R, 3R, 6R, ±0.5 %(D)

Test Item	Performance Requirements ΔR	Test Conditions
Resistance	Within Specified Tolerance	20 °C
T. C. R.	Within Specified T. C. R.	+25 °C/+125 °C
Overload	±2 %	Rated Voltage× 2.5, 5 s
Resistance to Soldering Heat	±1 %	270 °C, 10 s
Rapid Change of Temperature	±1 %	-55 °C (30 min.) / +155 °C (ERJ1R : +125 °C)(30 min.), 100 cycles
High Temperature Exposure	±1 %	+155 °C (ERJ1R : +125 °C), 1000 h
Damp Heat, Steady State	±1 %	60 °C, 90 % to 95 %RH, 1000 h
Load Life in Humidity	±2 % ERJ1R : ±3 %	60 °C, 90 % to 95 %RH, Rated Voltage, 1.5 h ON / 0.5 h OFF cycle, 1000 h
Endurance at 70 °C	±2 % ERJ1R : ±3 %	70 °C, Rated Voltage, 1.5 h ON / 0.5 h OFF cycle, 1000 h

● Series ERJXGN, 1GN, 2RC, 2RK, 3EK, 6EN, 8EN, 14N, 12N, 12S, 1TN, ±1 %(F)

Test Item	Performance Requirements ΔR	Test Conditions
Resistance	Within Specified Tolerance	20 °C
T. C. R.	Within Specified T. C. R.	+25 °C/+155 °C (ERJXG,ERJ1G : +25°C/+125 °C)
Overload	±2 %	Rated Voltage× 2.5, 5 s
Resistance to Soldering Heat	±1 %	270 °C, 10 s
Rapid Change of Temperature	±1 %	-55 °C (30 min.)/+155 °C (ERJXG,ERJ1G : +125 °C)(30 min.), 100 cycles
High Temperature Exposure	±1 %	+155 °C (ERJXG,ERJ1G : +125 °C), 1000 h
Damp Heat, Steady State	±1 %	60 °C, 90 % to 95 %RH, 1000 h
Load Life in Humidity	±2 % ERJXG,1G : ±3 %	60 °C, 90 % to 95 %RH, Rated Voltage, 1.5 h ON / 0.5 h OFF cycle, 1000 h
Endurance at 70 °C	±2 % ERJXG,1G : ±3 %	70 °C, Rated Voltage, 1.5 h ON / 0.5 h OFF cycle, 1000 h

Thin Film Chip Resistors, High Stability and Reliability Type

ERA V (High resistance value ERA K)

Series: ERA 2V, 3V, 6V

(Series: ERA 3K, 6K)



Features

- High reliability..... Stable at high temperature and humidity
(85 °C 85 %RH rated load, Category temperature range : -55 °C to +155 °C)
- High accuracy..... Low resistance tolerance and Temperature Coefficient of Resistance
- High performance... Low current noise, excellent linearity
- Anti-ESD..... Original structure for high ESD performance
(AEC-Q200-002 HBM Level 1c and above)
- Anti-sulfurated..... Original structure for sulfurated performance
- Reference Standard..... IEC 60115-8, JIS C 5201-8, JEITA RC-2133C
- AEC-Q200 compliant
- RoHS compliant

■ As for Packaging Methods, Land Pattern, Soldering Conditions and Safety Precautions,
Please see Data Files

Explanation of Part Numbers

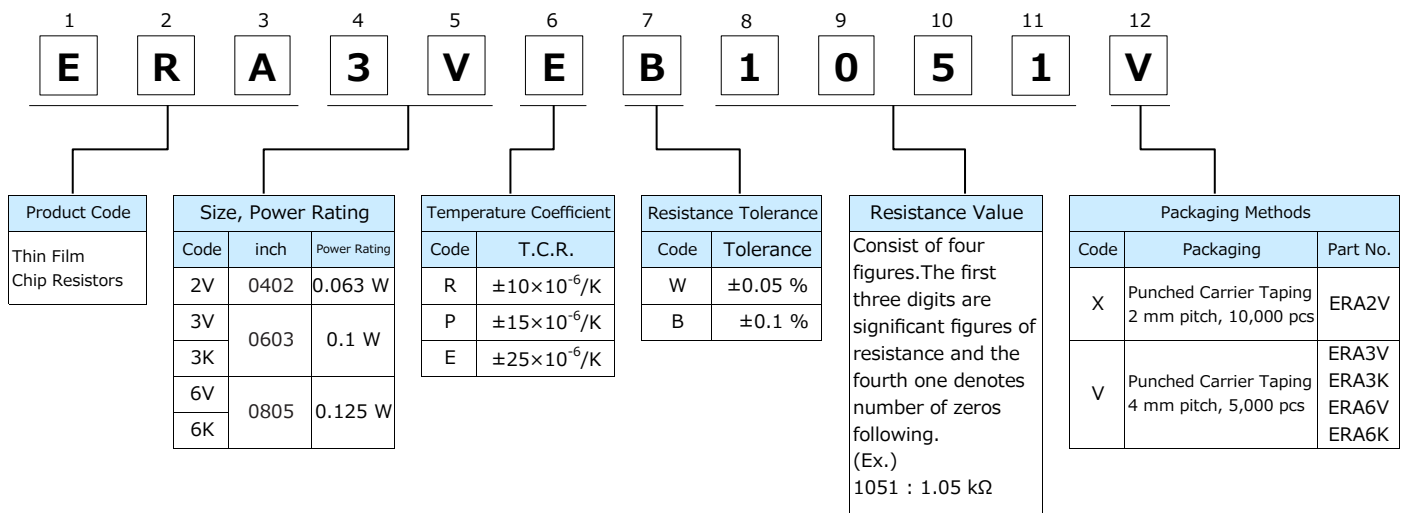

Ratings

Part No. (inch size)	Power Rating at 85 °C ⁽¹⁾ (W)	Limiting Element Voltage ⁽²⁾ (V)	Maximum Overload Voltage ⁽³⁾ (V)	Part No. (detail)	Resistance Tolerance (%)	T.C.R. ($\times 10^{-6}/K$)	Resistance Range ⁽⁴⁾ (Ω)	Category Temperature Range (°C)	AEC-Q200 Grade
ERA2V (0402)	0.063	50	100	ERA2VEB	±0.1	±25	47 to 10 k (E24, E96)	-55 to +155	Grade 0
				ERA2VPB	±0.1	±15	1 K to 10 k (E24, E96)		
				ERA2VRB	±0.1	±10			
				ERA2VRW	±0.05				
ERA3V (0603)	0.1	75	150	ERA3VEB	±0.1	±25	47 to 100 k (E24, E96)		
				ERA3VPB	±0.1	±15	1 K to 100 k (E24, E96)		
				ERA3VRB	±0.1	±10			
				ERA3VRW	±0.05				
ERA3K (0603)	0.1	75	150	ERA3KEB	±0.1	±25	102 K to 240 k (E24, E96)		
ERA6V (0805)	0.125	100	200	ERA6VEB	±0.1	±25	47 to 100 k (E24, E96)		
				ERA6VPB	±0.1	±15	1 K to 100 k (E24, E96)		
				ERA6VRB	±0.1	±10			
				ERA6VRW	±0.05				
ERA6K (0805)	0.125	100	200	ERA6KEB	±0.1	±25	102 K to 750 k (E24, E96)		

- (1) Use it on the condition that the case temperature is below the upper category temperature.
- (2) Rated Continuous Working Voltage (RCWV) shall be determined from $RCWV = \sqrt{\text{Power Rating} \times \text{Resistance Values}}$, or Limiting Element Voltage listed above, whichever less.
- (3) Overload Test Voltage (OTV) shall be determined from $OTV = \text{Specified Magnification (2.5)} \times RCWV$ or Maximum Overload Voltage listed above, whichever less.
- (4) E192 series resistance values are also available. The E192 series has custom part numbers. Please contact us for details.

Power Derating Curve

For resistors operated in ambient temperatures above 85 °C, power rating shall be derated in accordance with the figure on the right.

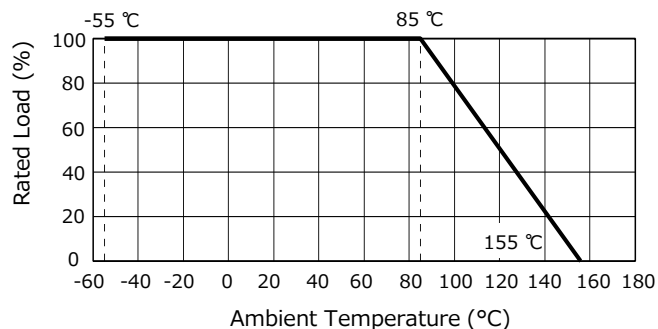

Construction

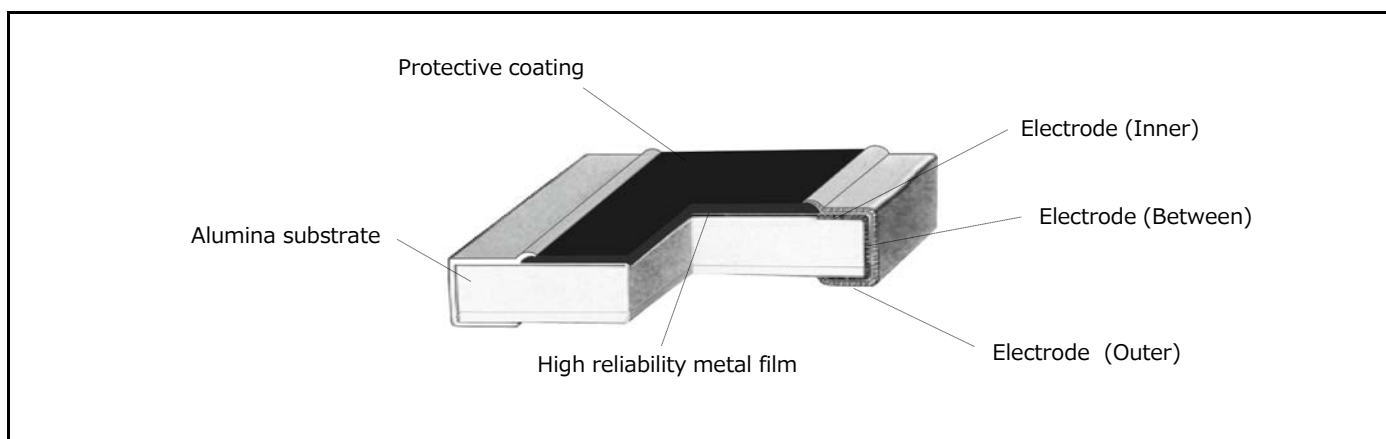

Dimensions in mm (not to scale)

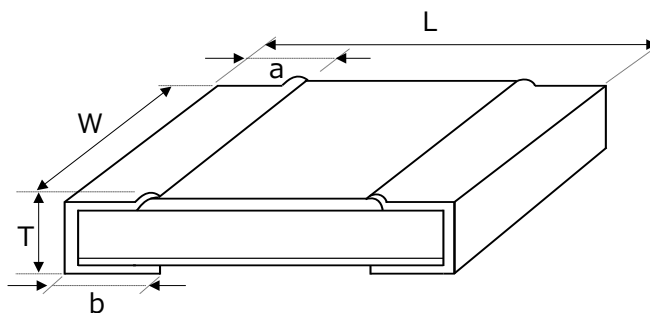

Part No.	Dimensions (mm)					Mass (Weight) (g/1000 pcs)
	L	W	a	b	T	
ERA2V	1.00±0.05	0.50+0.10/-0.05	0.25±0.10	0.25±0.10	0.35±0.05	0.6
ERA3V, 3K	1.60±0.15	0.80±0.10	0.30±0.20	0.30±0.20	0.45±0.10	2
ERA6V, 6K	2.00±0.20	1.25±0.10	0.40±0.20	0.40±0.20	0.55±0.10	5

Performance

Test Item	Performance Requirements ΔR	Test Conditions
Resistance	Within Specified Tolerance	20 °C
T. C. R.	Within Specified T. C. R.	+25 °C/+125 °C
Overload	±0.1 %	Rated Voltage× 2.5, 5 s
Resistance to Soldering Heat	±0.1 %	270 °C, 10 s
Rapid Change of Temperature	±0.1 %	-55 °C (30 min.) / +155 °C (30 min.), 1000 cycles
High Temperature Exposure	±0.1 %	+155 °C, 1000 h
Damp Heat, Steady State	±0.1 %	85 °C, 85 %RH, 1000 h
Load Life in Humidity	±0.1 %	85 °C, 85 %RH, 10 % of Rated Power ⁽¹⁾ , 1.5 h ON / 0.5 h OFF cycle , 1000 h
Endurance at 85 °C	±0.1 %	85 °C , Rated Voltage, 1.5 h ON / 0.5 h OFF cycle, 1000 h
Electro Static Discharge (HBM)	±0.1 % ⁽²⁾	AEC-Q200-002 : 150 pF, 2000 Ω , positive 5 times, negative 5 times ERA2V : 1.0 kV (level 1c) ERA3V(3K) : 1.5 kV (level 1c) ERA6V(6K) : 2.0 kV (level 2)

(1) Applied Voltage is " $\sqrt{0.1 \times \text{Power Rating} \times \text{Resistance Values}}$ ", or "Limiting Element Voltage×0.316", whichever less.

(2) Depends on resistance value.

Metal Film (Thin Film) Chip Resistors, High Reliability Type



Series: ERA 1A, 2A, 3A, 6A, 8A

Features

- High reliability……… Stable at high temperature and humidity
(85 °C 85 %RH rated load, Category temperature range : -55 °C to +155 °C)
- High accuracy……… Low resistance tolerance and Temperature Coefficient of Resistance
- High performance… Low current noise, excellent linearity
- Reference Standard……… IEC 60115-8, JIS C 5201-8, JEITA RC-2133C
- AEC-Q200 compliant (except ERA1A)
- RoHS compliant

■ As for Packaging Methods, Land Pattern, Soldering Conditions and Safety Precautions,
Please see Data Files

Explanation of Part Numbers

● E24 Series

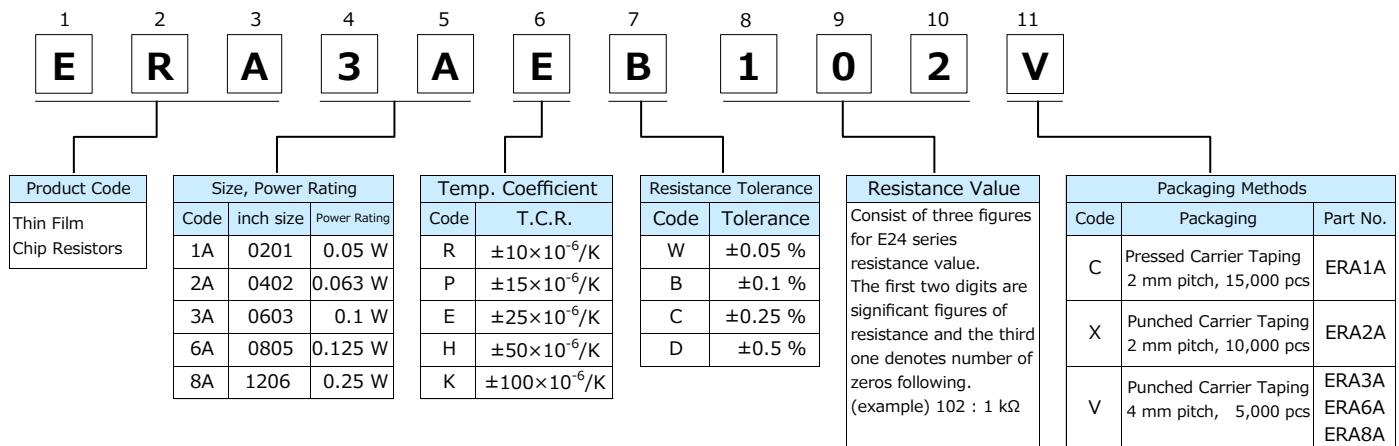

● E96 Series and other Resistance values

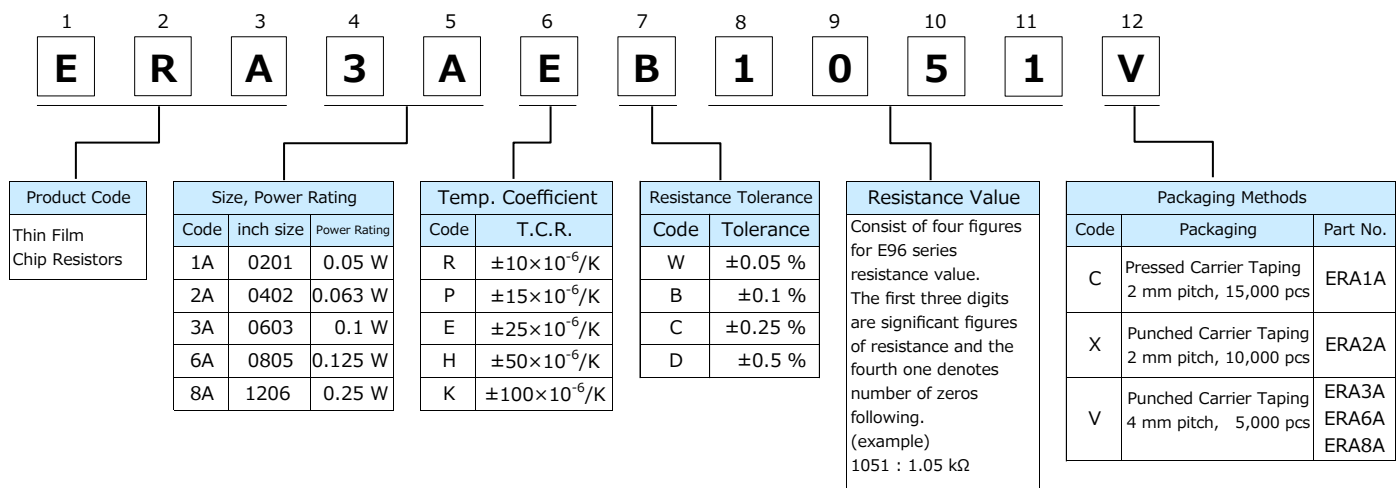

Note : Duplicated resistance values as E24 series part numbers shall follow E24 part numbers.
(apply three digit resistance value)

Ratings

Part No. (inch size)	Power Rating at 85 °C ⁽¹⁾ (W)	Limiting Element Voltage ⁽²⁾ (V)	Maximum Overload Voltage ⁽³⁾ (V)	Part No. (detail)	Resistance Tolerance (%)	T.C.R. (×10 ⁻⁶ /K)	Resistance Range ⁽⁴⁾⁽⁵⁾ (Ω)	Category Temperature Range (°C)	AEC-Q200 Grade
ERA1A (0201)	0.05	25	50	ERA1AEB	±0.1	±25	100 to 10 k (E24,E96)	-55 to +155	-
				ERA1AEC	±0.25				
				ERA1ARC	±0.25	±10	100 to 10 k (E24,E96)		
				ERA1ARB	±0.1				
ERA1ARW	±0.05	1 k to 10 k (E24,E96)							
ERA2A (0402)	0.063	50	100	ERA2AKD	±0.5	±100	10 to 46.4 (E24,E96)		
				ERA2AED	±0.5	±25	47 to 100 k (E24,E96)		
				ERA2AEC	±0.25				
				ERA2AEB	±0.1	±15	200 to 47 k (E24,E96)		
				ERA2APC	±0.25				
				ERA2APB	±0.1				
				ERA2ARC	±0.25	±10	200 to 47 k (E24,E96)		
ERA2ARB	±0.1								
ERA3A (0603)	0.1	75	150	ERA3AHD	±0.5	±50	10 to 46.4 (E24,E96)		
				ERA3AED	±0.5	±25	47 to 330 k (E24,E96)		
				ERA3AEC	±0.25				
				ERA3AEB	±0.1	±15	470 to 100 k (E24,E96)		
				ERA3APC	±0.25				
				ERA3APB	±0.1				
				ERA3ARC	±0.25	±10	1 k to 100 k (E24,E96)		
ERA3ARB	±0.1								
ERA3ARW	±0.05								
ERA6A (0805)	0.125	100	200	ERA6AHD	±0.5	±50	10 to 46.4 (E24,E96)		
				ERA6AED	±0.5	±25	47 to 1 M (E24,E96)		
				ERA6AEC	±0.25				
				ERA6AEB	±0.1	±15	470 to 100 k (E24,E96)		
				ERA6APC	±0.25				
				ERA6APB	±0.1				
				ERA6ARC	±0.25	±10	1 k to 100 k (E24,E96)		
ERA6ARB	±0.1								
ERA6ARW	±0.05								
ERA8A (1206)	0.25	150	300	ERA8AHD	±0.5	±50	10 to 46.4 (E24,E96)		
				ERA8AED	±0.5	±25	47 to 1 M (E24,E96)		
				ERA8AEC	±0.25				
				ERA8AEB	±0.1	±15	470 to 100 k (E24,E96)		
				ERA8APC	±0.25				
				ERA8APB	±0.1				
				ERA8ARC	±0.25	±10	1 k to 100 k (E24,E96)		
ERA8ARB	±0.1								
ERA8ARW	±0.05								

- (1) Use it on the condition that the case temperature is below the upper category temperature.
- (2) Rated Continuous Working Voltage (RCWV) shall be determined from $RCWV = \sqrt{\text{Power Rating} \times \text{Resistance Values}}$, or Limiting Element Voltage listed above, whichever less.
- (3) Overload Test Voltage (OTV) shall be determined from $OTV = \text{Specified Magnification} (2.5) \times RCWV$ or Maximum Overload Voltage listed above, whichever less.
- (4) E192 series resistance values are also available. Please contact us for details.
- (5) Duplicated resistance values between E96, E192 and E24 series shall follow E24 Part Numbers. (apply three digit resistance value)

Power Derating Curve

For resistors operated in ambient temperatures above 85 °C, power rating shall be derated in accordance with the figure on the right.

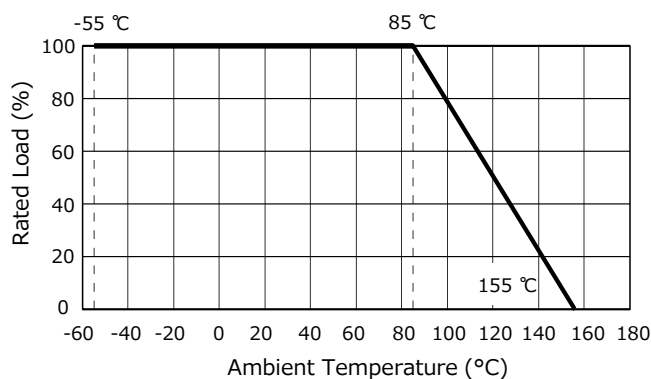

Construction

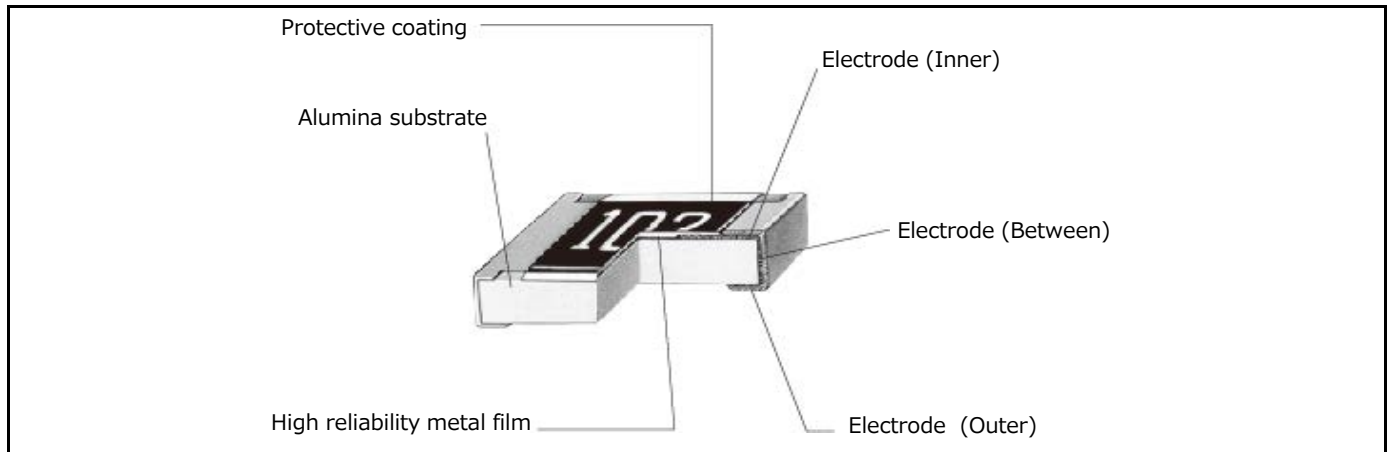

*0402 size, 0603 size and E96 series do not have value markings.

Dimensions in mm (not to scale)

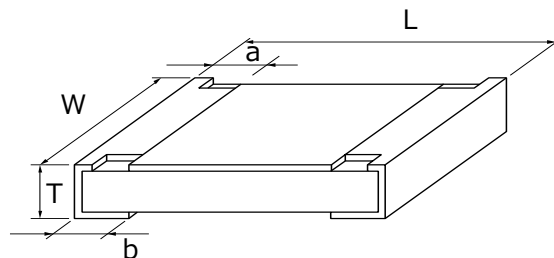

Part No.	Dimensions (mm)					Mass (Weight) (g/1000 pcs)
	L	W	a	b	T	
ERA1A	0.60±0.03	0.30±0.03	0.15±0.05	0.15±0.05	0.23±0.03	0.14
ERA2A	1.00±0.10	0.50+0.10/-0.05	0.15±0.10	0.25±0.10	0.35±0.05	0.6
ERA3A	1.60±0.20	0.8±0.20	0.30±0.20	0.30±0.15	0.45±0.10	2
ERA6A	2.00±0.20	1.25±0.10	0.40±0.25	0.40±0.25	0.60±0.10	4
ERA8A	3.20±0.20	1.60+0.05/-0.15	0.50±0.25	0.50±0.25	0.60±0.10	8

High Precision Thick Film Chip Resistors

Series: ERJ PB3, PB6

Features

- Achieve the resistance tolerance $\pm 0.1\%$ with high reliability metal glaze thick film resistor
- Guarantee the temperature coefficient of Resistance $\pm 50 \times 10^{-6}/K$ in high resistance range up to 1 M Ω
- High power ... 0.20 W : 0603 inch /1608 mm size (ERJPB3)
0.25 W : 0805 inch /2012 mm size (ERJPB6)
- Reference Standard ... IEC 60115-8, JIS C 5201-8, JEITA RC-2134C
- AEC-Q200 compliant
- RoHS compliant

■ As for Packaging Methods, Land Pattern, Soldering Conditions and Safety Precautions, Please see Data Files

Explanation of Part Numbers

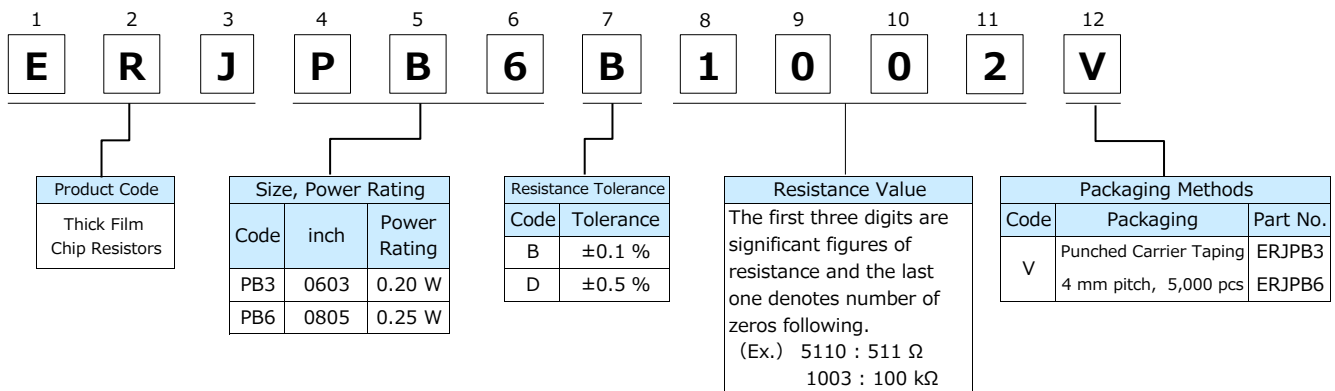

Ratings

Part No. (inch size)	Power Rating at 70 °C ⁽¹⁾ (W)	Limiting Element Voltage ⁽²⁾ (V)	Maximum Overload Voltage ⁽³⁾ (V)	Resistance Tolerance (%)	Resistance Range (Ω)	T.C.R. ($\times 10^{-6}/K$)	Category Temperature Range (°C)	AEC-Q200 Grade
ERJPB3 (0603)	0.20	150	200	± 0.1 ± 0.5	200 to 100 k (E24, E96)	± 50	-55 to +155	Grade 0
ERJPB6 (0805)	0.25	150	200	± 0.1 ± 0.5	200 to 1 M (E24, E96)	± 50	-55 to +155	Grade 0

(1) Use it on the condition that the case temperature is below the upper category temperature.

(2) Rated Continuous Working Voltage (RCWV) shall be determined from $RCWV = \sqrt{\text{Power Rating} \times \text{Resistance Value}}$, or Limiting Element Voltage listed above, whichever less.

(3) Overload Test Voltage (OTV) shall be determined from $OTV = \text{Specified Magnification (refer to performance)} \times RCWV$ or Maximum Overload Voltage listed above, whichever less.

Power Derating Curve

For resistors operated in ambient temperatures above 70 °C, power rating shall be derated in accordance with the figure on the right.

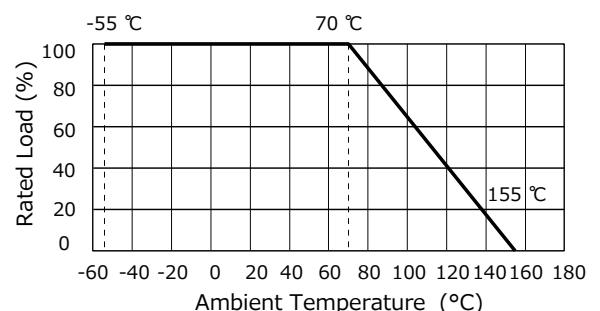

Construction

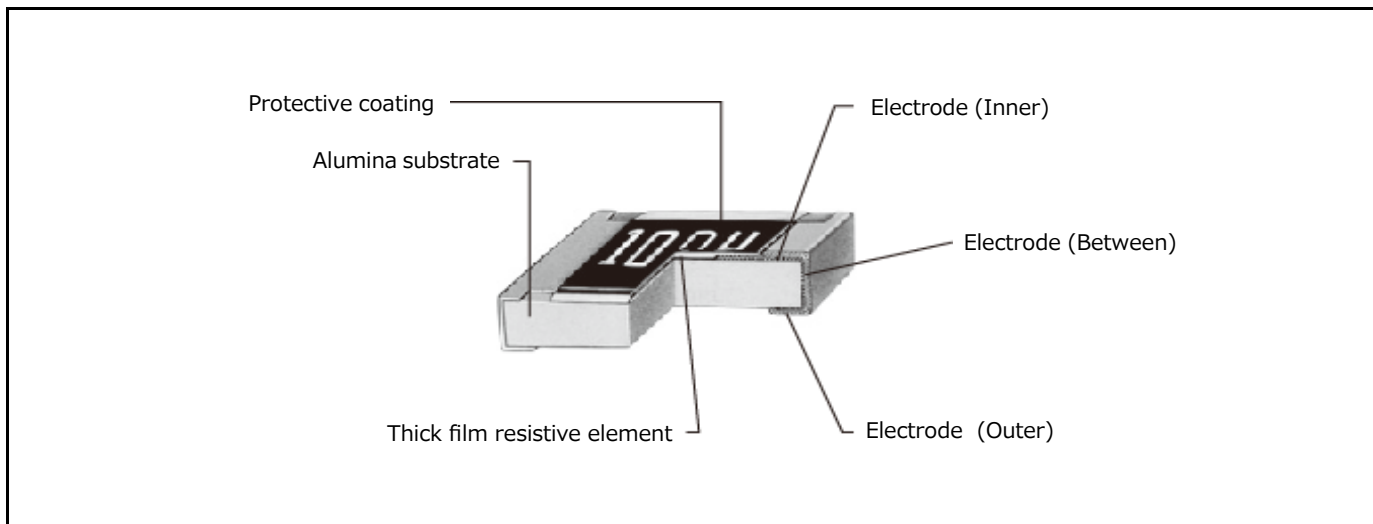

Dimensions in mm (not to scale)

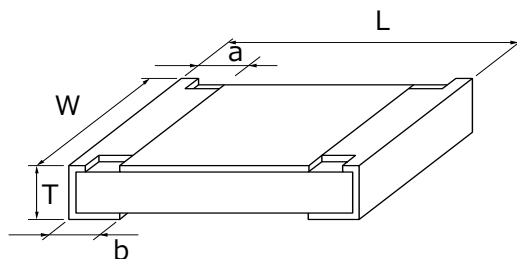

Part No.	Dimensions (mm)					Mass (Weight) (g/1000 pcs)
	L	W	a	b	T	
ERJPB3	1.60±0.15	0.80+0.15/-0.05	0.15+0.15/-0.10	0.25±0.10	0.45±0.10	2
ERJPB6	2.00±0.20	1.25±0.10	0.25±0.20	0.40±0.20	0.60±0.10	4

Performance

Test Item	Performance Requirements ΔR	Test Conditions
Resistance	Within Specified Tolerance	20 °C
T. C. R.	Within Specified T. C. R.	+25 °C/+125 °C
Overload	±0.5 %	Rated Voltage× 2.0, 5 s
Resistance to Soldering Heat	±0.5 %	270 °C, 10 s
Rapid Change of Temperature	±0.5 %	-55 °C (30 min.) / +155 °C (30 min.), 100 cycles
High Temperature Exposure	±0.5 %	+155 °C, 1000 h
Damp Heat, Steady State	±0.5 %	60 °C, 90 % to 95 %RH, 1000 h
Load Life in Humidity	±0.5 %	60 °C, 90 % to 95 %RH, Rated Voltage, 1.5 h ON / 0.5 h OFF cycle, 1000 h
Endurance at 70 °C	±0.5 %	70 °C, Rated Voltage , 1.5 h ON / 0.5 h OFF cycle, 1000 h

Thick Film Chip Resistors / Low Resistance Type

Series: ERJ 2LW, 3LW, 6LW,
ERJ 2BW, 3BW, 6BW, 8BW, 6CW, 8CW
ERJ 2B, 3B, 6D, 6B, 8B, 14B,
ERJ 3R, 6R, 8R, 14R, 12R, 12Z, 1TR
ERJ L03, L06, L08, L14, L12, L1D, L1W

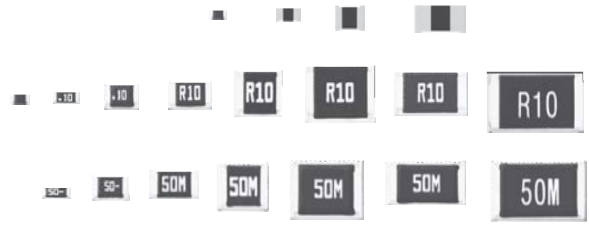

Features

- Current Sensing resistor
- Small size and lightweight
- Realize both low-resistance & High-precision by original thick film resistive element & special electrode structure
- Suitable for both reflow and flow soldering
- Realize High-power by double-sided resistive elements structure that aimed to suppress temperature rising... ERJ2LW, 3LW, 6LW, 2BW, 3BW, 6BW, 8BW, 6CW, 8CW
- Low TCR..... $\pm 75 \times 10^{-6} / K$ (ERJ6CW, ERJ8CW)
- Low Resistance Value... Thick film resistors available from 5 mΩ (ERJ3LW, 6LW)
- Reference Standard..... IEC 60115-8, JIS C 5201-8, JEITA RC-2144
- AEC-Q200 compliant
- RoHS compliant

■ **As for Packaging Methods, Land Pattern, Soldering Conditions and Safety Precautions,**
Please see Data Files

Explanation of Part Numbers

- ERJ2LW, 3LW, 6LW, 2BW, 3BW, 6BW, 8BW, 6CW, 8CW
<High power (double-sided resistive elements structure) type>

1	2	3	4	5	6	7	8	9	10	11	12
E	R	J	2	B	W	G	R	0	4	7	X

Product Code	Code	inch size	Power Rating	Resistance Value	Resistance Tolerance	Resistance Value	Packaging Methods
Thick Film Chip Resistors	2LW	0402	0.2 W	10 mΩ	D ±0.5 %*	Shown by 4 digits or letters. (Ex.) R005 : 0.05 Ω = 5 mΩ R047 : 0.047 Ω = 47 mΩ	X Pressed Carrier Taping 2 mm pitch, 10,000 pcs
	3LW	0603	0.25 W	5 mΩ, 10 mΩ			
	6LW	0805	0.5 W	5, 6, 7, 8, 9 mΩ	F ±1 %		V Punched Carrier Taping 4 mm pitch, 5,000 pcs
	2BW	0402	0.25 W	47 m to 100 mΩ	G ±2 %		
	3BW	0603	0.33 W	20 m to 100 mΩ	J ±5 %		
	6BW	0805	0.5 W	10 m to 100 mΩ			
	8BW	1206	1 W	10 m to 100 mΩ			
	6CW	0805	0.5 W	10 m to 30 mΩ			
8CW	1206	1 W	10 m to 50 mΩ				

*Please refer to the rating table for the resistance tolerance.

- ERJ2BS/2BQ, 3BS/3BQ, 6BS/6BQ, 8BS/8BQ, 14BS/14BQ, 6D, 3R, 6R, 8R, 14R, 12R, 12Z, 1TR <High power type/Standard type>

1	2	3	4	5	6	7	8	9	10	11
E	R	J	8	R	Q	F	R	2	2	V

Product Code	
Thick Film Chip Resistors	

Size, Power Rating		
Code	inch size	Power Rating
2B	0402	0.166 W
3B	0603	0.25 W
3R	0603	0.1 W
6D	0805	0.5 W
6B	0805	0.33 W
6R	0805	0.125 W
8B	1206	0.5 W
8R	1206	0.25 W
14B	1210	0.5 W
14R	1210	0.25 W
12R	1812	0.5 W
12Z	2010	0.5 W
1TR	2512	1 W

Resistance Value Region	
S	0.1Ω to 0.2Ω
Q	0.22Ω to 9.1Ω*

*2B:0.22 Ω to 1.0 Ω

Resistance Tolerance	
Code	Tolerance
D	±0.5 %*
F	±1 %
G	±2 %
J	±5 %

*Please refer to the □ rating table for the resistance tolerance.

Resistance Value

Shown by 3 digits or letters. Only when it is D (E24,E96) or F (E96), shown by 4 digits or letters. (Ex.)
R22 : 0.22 Ω
R102 : 0.102 Ω

Packaging Methods		
Code	Packaging	Part No.
X	Punched Carrier Taping 2 mm pitch,10,000 pcs	ERJ2B
V	Punched Carrier Taping 4 mm pitch, 5,000 pcs	ERJ3B/3R ERJ6D/6B/ ERJ6R ERJ8B/8R
U	Embossed Carrier Taping 4 mm pitch, 5,000 pcs	ERJ14B/14R ERJ12R ERJ12Z
	Embossed Carrier Taping 4 mm pitch, 4,000 pcs	ERJ1TR

- ERJL03, L06, L08, L14, L12, L1D, L1W <Low TCR type>

1	2	3	4	5	6	7	8	9	10	11	12
E	R	J	L	1	4	K	J	5	0	M	U

Product Code	
Thick Film Chip Resistors	

Size, Power Rating		
Code	inch size	Power Rating
L03	0603	0.2 W
L06	0805	0.25 W
L08	1206	0.33 W
L14	1210	0.33 W
L12	1812	0.5 W
L1D	2010	0.5 W
L1W	2512	1 W

Code	Resistance Value
K	Standard *
	20 mΩ, 22 mΩ, 33 mΩ, 39 mΩ, 47 mΩ, 50 mΩ, 100mΩ
U	20 mΩ to 100 mΩ *

* L03, L06, L08 : 47 mΩ to 100 mΩ
L1D, L1W : 40 mΩ to 100 mΩ

Resistance Tolerance	
Code	Tolerance
F	±1 %
J	±5 %

Resistance Value

Shown by 3 digits or letters. (Ex.)
50M : 50 mΩ,
10C : 100 mΩ

Packaging Methods		
Code	Packaging	Part No.
V	Punched Carrier Taping 4 mm pitch, 5,000 pcs	ERJL03 ERJL06 ERJL08
U	Embossed Carrier Taping 4 mm pitch, 5,000 pcs	ERJL14 ERJL12 ERJL1D
	Embossed Carrier Taping 4 mm pitch, 3,000 pcs	ERJL1W

Ratings

<High power (double-sided resistive elements structure) type>

Part No. (inch size)	Power Rating at 70 °C ⁽¹⁾ (W)	Resistance Tolerance (%)	Resistance Range ⁽²⁾ (Ω)	T.C.R. (×10 ⁻⁶ /K)	Category Temperature Range (°C)	AEC- Q200 Grade
ERJ2LW (0402)	0.2	±1, ±2, ±5	10 m	0 to +500	-55 to +125	Grade 1
ERJ3LW (0603)	0.25	±1, ±2, ±5	5 m	0 to +700	-55 to +125	Grade 1
			10 m	0 to +300	-55 to +125	
ERJ6LW (0805)	0.5	±1, ±2, ±5	5, 6, 7, 8, 9 m	0 to +300	-55 to +125	Grade 1
ERJ2BW (0402)	0.25	±1, ±2, ±5	47 m to 100 m (E24)	0 to +300	-55 to +155	Grade 0
ERJ3BW (0603)	0.33	±1, ±2, ±5	20 m to 100 m (E24)	20 mΩ ≤ R < 39 mΩ:0 to +250 39 mΩ ≤ R ≤ 100 mΩ:0 to +150	-55 to +155	Grade 0
ERJ6BW (0805)	0.5	±1, ±2, ±5	10 m to 100 m (E24)	10 mΩ ≤ R < 15 mΩ:0 to +300 15 mΩ ≤ R ≤ 100 mΩ:0 to +200	-55 to +155	Grade 0
ERJ8BW (1206)	1	±1, ±2, ±5	10 m to 100 m (E24)	10 mΩ ≤ R < 20 mΩ:0 to +200 20 mΩ ≤ R < 47 mΩ:0 to +150 47 mΩ ≤ R ≤ 100 mΩ:0 to +100	-55 to +155	Grade 0
ERJ6CW (0805)	0.5	±0.5, ±1, ±2, ±5	10 m to 30 m (E24)	±75	-55 to +125	Grade 1
ERJ8CW (1206)	1	±1, ±2, ±5	10 m to 50 m (E24)	±75	-55 to +125	Grade 1

(1) Use it on the condition that the case temperature is below the upper category temperature.

- Rated Continuous Working Voltage (RCWV) shall be determined from $RCWV = \sqrt{\text{Power Rating} \times \text{Resistance Value}}$.
- Overload Test Voltage (OTV) shall be determined from $OTV = \text{Specified Magnification (refer to performance)} \times RCWV$.

(2) Please contact us when resistors of irregular series are needed.

Ratings

<High power type>

Part No. (inch size)	Power Rating at 70 °C ⁽¹⁾ (W)	Resistance Tolerance ⁽²⁾ (%)	Resistance Range ⁽³⁾ (Ω)	T.C.R. (×10 ⁻⁶ /K)	Category Temperature Range (°C)	AEC- Q200 Grade
ERJ2BS (0402)	0.166	±1, ±2, ±5	0.10 to 0.20 (E24)	0.10 Ω ≤ R < 0.22 Ω : 0 to +300	-55 to +155	Grade 0
ERJ2BQ (0402)			0.22 to 1.0 (E24)	0.22 Ω ≤ R ≤ 1.0 Ω : 0 to +250		
ERJ3BS (0603)	0.25	±1, ±2, ±5	0.10 to 0.20 (E24)	0.10 Ω ≤ R < 0.22 Ω : 0 to +300	-55 to +155	Grade 0
ERJ3BQ (0603)			0.22 to 0.91 (E24)	0.22 Ω ≤ R < 1.0 Ω : 0 to +300		
			1.0 to 9.1 (E24)	1.0 Ω ≤ R ≤ 9.1 Ω : ±200		
ERJ6DS (0805)	0.5	±0.5, ±1, ±2, ±5	0.10 to 0.20 (E24,E96)	0.10 Ω ≤ R < 0.22 Ω : 0 to +150	-55 to +155	Grade 0
ERJ6DQ (0805)			0.22 to 9.1 (E24,E96)	0.22 Ω ≤ R < 1.0 Ω : 0 to +100 1.0 Ω ≤ R ≤ 9.1 Ω : ±100		
ERJ6BS (0805)	0.33	±1, ±2, ±5	0.10 to 0.20 (E24)	0.10 Ω ≤ R < 0.22 Ω : 0 to +250	-55 to +155	Grade 0
ERJ6BQ (0805)			0.22 to 0.91 (E24)	0.22 Ω ≤ R < 1.0 Ω : 0 to +250		
			1.0 to 9.1 (E24)	1.0 Ω ≤ R ≤ 9.1 Ω : ±200		
ERJ8BS (1206)	0.5	±1, ±2, ±5	0.10 to 0.20 (E24)	0.10 Ω ≤ R < 0.22 Ω : 0 to +250	-55 to +155	Grade 0
ERJ8BQ (1206)			0.22 to 0.91 (E24)	0.22 Ω ≤ R < 1.0 Ω : 0 to +250		
			1.0 to 9.1 (E24)	1.0 Ω ≤ R ≤ 9.1 Ω : ±200		
ERJ14BS (1210)	0.5	±1, ±2, ±5	0.10 to 0.20 (E24)	0.10 Ω ≤ R < 0.22 Ω : 0 to +200	-55 to +155	Grade 0
ERJ14BQ (1210)			0.22 to 0.91 (E24)	0.22 Ω ≤ R < 1.0 Ω : 0 to +200		
			1.0 to 9.1 (E24)	1.0 Ω ≤ R ≤ 9.1 Ω : ±100		

(1) Use it on the condition that the case temperature is below the upper category temperature.

(2) E96 series also have ±0.5 %, ±1 % line-up.

• Rated Continuous Working Voltage (RCWV) shall be determined from $RCWV = \sqrt{\text{Power Rating} \times \text{Resistance Value}}$.

• Overload Test Voltage (OTV) shall be determined from $OTV = \text{Specified Magnification (refer to performance)} \times RCWV$.

(3) Please contact us when resistors of irregular series are needed.

<Standard type>

Part No. (inch size)	Power Rating at 70 °C ⁽¹⁾ (W)	Resistance Tolerance (%)	Resistance Range ⁽²⁾ (Ω)	T.C.R. (×10 ⁻⁶ /K)	Category Temperature Range (°C)	AEC- Q200 Grade
ERJ3RS (0603)	0.1	±1, ±2, ±5	0.10 to 0.20 (E24)	0.10 Ω ≤ R < 0.22 Ω : 0 to +300	-55 to +155	Grade 0
ERJ3RQ (0603)			0.22 to 0.91 (E24)	0.22 Ω ≤ R < 1.0 Ω : 0 to +300		
			1.0 to 9.1 (E24)	1.0 Ω ≤ R ≤ 9.1 Ω : ±200		
ERJ6RS (0805)	0.125	±1, ±2, ±5	0.10 to 0.20 (E24)	0.10 Ω ≤ R < 0.22 Ω : 0 to +250	-55 to +155	Grade 0
ERJ6RQ (0805)			0.22 to 0.91 (E24)	0.22 Ω ≤ R < 1.0 Ω : 0 to +250		
			1.0 to 9.1 (E24)	1.0 Ω ≤ R ≤ 9.1 Ω : ±200		
ERJ8RS (1206)	0.25	±1, ±2, ±5	0.10 to 0.20 (E24)	0.10 Ω ≤ R < 0.22 Ω : 0 to +250	-55 to +155	Grade 0
ERJ8RQ (1206)			0.22 to 0.91 (E24)	0.22 Ω ≤ R < 1.0 Ω : 0 to +250		
			1.0 to 9.1 (E24)	1.0 Ω ≤ R ≤ 9.1 Ω : ±200		
ERJ14RS (1210)	0.25	±1, ±2, ±5	0.10 to 0.20 (E24)	0.10 Ω ≤ R < 0.22 Ω : 0 to +200	-55 to +155	Grade 0
ERJ14RQ (1210)			0.22 to 0.91 (E24)	0.22 Ω ≤ R < 1.0 Ω : 0 to +200		
			1.0 to 9.1 (E24)	1.0 Ω ≤ R ≤ 9.1 Ω : ±100		
ERJ12RS (1812)	0.5	±1, ±2, ±5	0.10 to 0.20 (E24)	0.10 Ω ≤ R < 0.22 Ω : 0 to +200	-55 to +155	Grade 0
ERJ12RQ (1812)			0.22 to 0.91 (E24)	0.22 Ω ≤ R < 1.0 Ω : 0 to +200		
			1.0 to 9.1 (E24)	1.0 Ω ≤ R ≤ 9.1 Ω : ±100		
ERJ12ZS (2010)	0.5	±1, ±2, ±5	0.10 to 0.20 (E24)	0.10 Ω ≤ R < 0.22 Ω : 0 to +200	-55 to +155	Grade 0
ERJ12ZQ (2010)			0.22 to 0.91 (E24)	0.22 Ω ≤ R < 1.0 Ω : 0 to +200		
			1.0 to 9.1 (E24)	1.0 Ω ≤ R ≤ 9.1 Ω : ±100		
ERJ1TRS (2512)	1	±1, ±2, ±5	0.10 to 0.20 (E24)	0.10 Ω ≤ R < 0.22 Ω : 0 to +200	-55 to +155	Grade 0
ERJ1TRQ (2512)			0.22 to 0.91 (E24)	0.22 Ω ≤ R < 1.0 Ω : 0 to +200		
			1.0 to 9.1 (E24)	1.0 Ω ≤ R ≤ 9.1 Ω : ±100		

(1) Use it on the condition that the case temperature is below the upper category temperature.

• Rated Continuous Working Voltage (RCWV) shall be determined from $RCWV = \sqrt{\text{Power Rating} \times \text{Resistance Value}}$.

• Overload Test Voltage (OTV) shall be determined from $OTV = \text{Specified Magnification (refer to performance)} \times RCWV$.

(2) Please contact us when resistors of irregular series are needed.

Ratings

<Low TCR type>

Part No. (inch size)	Power Rating at 70 °C ⁽¹⁾ (W)	Resistance Tolerance (%)	Resistance Range ⁽²⁾ (Ω)	T.C.R. (×10 ⁻⁶ /K)	Category Temperature Range (°C)	AEC- Q200 Grade
ERJL03 (0603)	0.2	±1, ±5	47 m to 100 m	±200	-55 to +125	Grade 1
ERJL06 (0805)	0.25	±1, ±5	47 m to 100 m	±100	-55 to +125	Grade 1
ERJL08 (1206)	0.33	±1, ±5	47 m to 100 m	±100	-55 to +125	Grade 1
ERJL14 (1210)	0.33	±1, ±5	20 m to 100 m	R < 47 mΩ : ±300 R ≥ 47 mΩ : ±100	-55 to +125	Grade 1
ERJL12 (1812)	0.5	±1, ±5	20 m to 100 m		-55 to +125	Grade 1
ERJL1D (2010)	0.5	±1, ±5	40 m to 100 m		-55 to +125	Grade 1
ERJL1W (2512)	1	±1, ±5	40 m to 100 m		-55 to +125	Grade 1

(1) Use it on the condition that the case temperature is below the upper category temperature.

- Rated Continuous Working Voltage (RCWV) shall be determined from $RCWV = \sqrt{\text{Power Rating} \times \text{Resistance Value}}$.
- Overload Test Voltage (OTV) shall be determined from $OTV = \text{Specified Magnification (refer to performance)} \times RCWV$.

(2) Standard R.V. : 20 mΩ, 22 mΩ, 33 mΩ, 39 mΩ, 47 mΩ, 50 mΩ, 100 mΩ, Custom R.V. : Each 1 mΩ within upper range.

Power Derating Curve

For resistors operated in ambient temperatures above 70 °C, power rating shall be derated in accordance with the figure on the right.

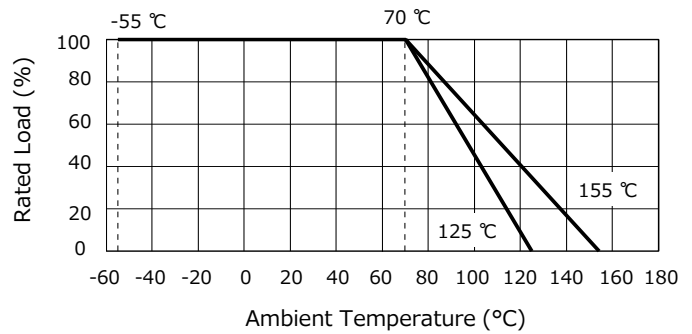

Construction

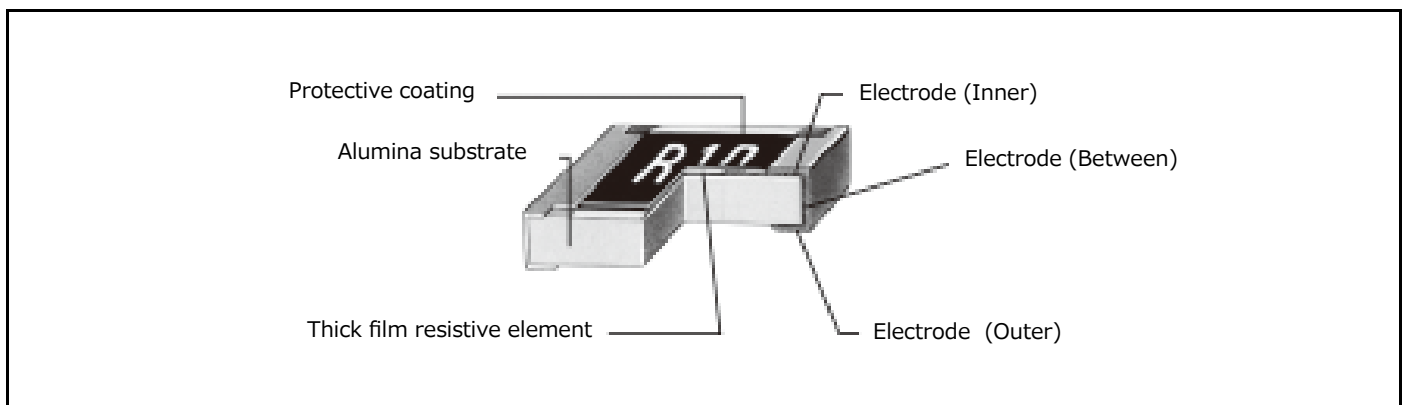

Dimensions in mm (not to scale)

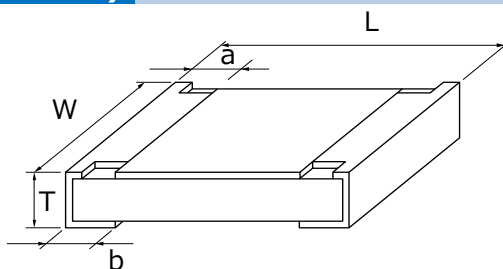

Part No.	Dimensions (mm)					Mass (Weight) (g/1000pcs)
	L	W	a	b	T	
ERJ2LW	1.00±0.10	0.50+0.10/-0.05	0.25±0.10	0.25±0.10	0.40±0.05	0.8
ERJ2BW	1.00±0.10	0.50+0.10/-0.05	0.24±0.10	0.24±0.10	0.35±0.05	0.8
ERJ2B	1.00±0.10	0.50+0.10/-0.05	0.20±0.10	0.27±0.10	0.35±0.05	0.8
ERJ3LW (5 mΩ)	1.60±0.15	0.80±0.15	0.50±0.20	0.50±0.20	0.55±0.10	3
ERJ3LW (10 mΩ) ERJ3BW	1.60±0.15	0.80±0.15	0.40±0.20	0.40±0.20	0.55±0.10	3
ERJ3R ERJ3B ERJL03	1.60±0.15	0.80+0.15/-0.05	0.30±0.20	0.30±0.15	0.45±0.10	2
ERJ6LW	2.00±0.20	1.25±0.20	0.63±0.20	0.63±0.20	0.70±0.10	6
ERJ6BW	2.00±0.20	1.25±0.20	0.55±0.20	0.55±0.20	0.65±0.10	6
ERJ6CW (10 to 13 mΩ)	2.05±0.20	1.30±0.20	0.60±0.20	0.60±0.20	0.65±0.10	6
ERJ6CW (15 to 30 mΩ)			0.45±0.20	0.45±0.20		
ERJ6D	2.00±0.20	1.25±0.10	0.40±0.20	0.55±0.25	0.60±0.10	5
ERJ6R ERJ6B ERJL06	2.00±0.20	1.25±0.10	0.40±0.20	0.40±0.20	0.60±0.10	5
ERJ8BW	3.20±0.20	1.60±0.20	1.00±0.20	1.00±0.20	0.65±0.10	13
ERJ8CW (10 to 16 mΩ)	3.20±0.20	1.60±0.20	1.10±0.20	1.10±0.20	0.65±0.10	13
ERJ8CW (18 to 50 mΩ)	3.20±0.20	1.60±0.20	0.60±0.20	0.60±0.20	0.65±0.10	13
ERJ8R ERJ8B ERJL08	3.20+0.05/-0.20	1.60+0.05/-0.15	0.50±0.20	0.50±0.20	0.60±0.10	10
ERJ14R ERJ14B ERJL14	3.20±0.20	2.50±0.20	0.50±0.20	0.50±0.20	0.60±0.10	16
ERJ12R ERJL12	4.50±0.20	3.20±0.20	0.50±0.20	0.50±0.20	0.60±0.10	27
ERJ12Z ERJL1D	5.00±0.20	2.50±0.20	0.60±0.20	0.60±0.20	0.60±0.10	27
ERJ1TR	6.40±0.20	3.20±0.20	0.65±0.20	0.60±0.20	0.60±0.10	45
ERJL1W	6.40±0.20	3.20±0.20	0.65±0.20	1.30±0.20	1.10±0.10	79

Performance

- ERJ2LW, 3LW, 6LW, 2BW, 3BW, 6BW, 8BW, 6CW, 8CW
<High power (double-sided resistive elements structure) type>

Test Item	Performance Requirements ΔR	Test Conditions
Resistance	Within Specified Tolerance	20 °C
T. C. R.	Within Specified T. C. R.	+25 °C/+125 °C
Overload	±2 %	ERJ6LW : Rated Voltage× 1.77, 5 s ERJ8BW (R > 0.05 Ω) : Rated Voltage× 1.77, 5 s Other : Rated Voltage× 2.0 , 5 s
Resistance to Soldering Heat	±1 %	270 °C, 10 s
Rapid Change of Temperature	±1 % ERJ2LW : ±2 %	-55 °C (30min.) / +155 °C (ERJ□LW, ERJ□CW : +125 °C) (30 min.), 100 cycles
High Temperature Exposure	±1 %	+155 °C (ERJ□LW, ERJ□CW : +125 °C), 1000 h
Damp Heat, Steady State	±1 %	60 °C, 90 % to 95 %RH, 1000 h
Load Life in Humidity	±3 %	60 °C, 90 % to 95 %RH, Rated Voltage, 1.5 h ON / 0.5 h OFF cycle , 1000 h
Endurance at 70 °C	±3 %	70 °C, Rated Voltage, 1.5 h ON / 0.5 h OFF cycle, 1000 h

- ERJ2BS/2BQ, 3BS/3BQ, 6BS/6BQ, 8BS/8BQ, 14BS/14BQ, 6D, 3R, 6R, 8R, 14R, 12R, 12Z, 1TR
<High power type/Standard type>

Test Item	Performance Requirements ΔR	Test Conditions
Resistance	Within Specified Tolerance	20 °C
T. C. R.	Within Specified T. C. R.	+25 °C/+125 °C
Overload	±2 %	Rated Voltage× 2.5 (ERJ6D : ×1.77), 5 s
Resistance to Soldering Heat	±1 %	270 °C, 10 s
Rapid Change of Temperature	±1 %	-55 °C (30 min.) / +155 °C (30 min.), 100 cycles
High Temperature Exposure	±1 %	+155 °C, 1000 h
Damp Heat, Steady State	±1 %	60 °C, 90 % to 95 %RH, 1000 h
Load Life in Humidity	±3 %	60 °C, 90 % to 95 %RH, Rated Voltage, 1.5 h ON / 0.5 h OFF cycle , 1000 h
Endurance at 70 °C	±3 %	70 °C, Rated Voltage, 1.5 h ON / 0.5 h OFF cycle, 1000 h

- ERJL03, L06, L08, L14, L12, L1D, L1W < Low TCR type >

Test Item	Performance Requirements ΔR	Test Conditions
Resistance	Within Specified Tolerance	20 °C
T. C. R.	Within Specified T. C. R.	+25 °C/+125 °C
Overload	±2 %	Rated Voltage× 2.5, 5 s
Resistance to Soldering Heat	±1 %	270 °C, 10 s
Rapid Change of Temperature	±1 %	-55 °C (30 min.) / +125 °C (30 min.), 100 cycles
High Temperature Exposure	±1 %	+125 °C, 1000 h
Damp Heat, Steady State	±1 %	60 °C, 90 % to 95 %RH, 1000 h
Load Life in Humidity	±3 %	60 °C, 90 % to 95 %RH, Rated Voltage, 1.5 h ON / 0.5 h OFF cycle , 1000 h
Endurance at 70 °C	±3 %	70 °C, Rated Voltage, 1.5 h ON / 0.5 h OFF cycle, 1000 h

Current Sensing Resistors, Metal Plate Type



Series: ERJ MS4, MB1

Features

- Ideal for current sensing solution
- Small case size with high power
- Metal plate bonding technology. Excellent long term stability
- Outer Resin with high heat dissipation. Wide temperature range (-65 °C to +170 °C)
- AEC-Q200 compliant
- RoHS compliant
- ISO9001, ISO/TS16949 certified

■ As for Packaging Methods, Land Pattern, Soldering Conditions and Safety Precautions, Please see Data Files

Explanation of Part Numbers

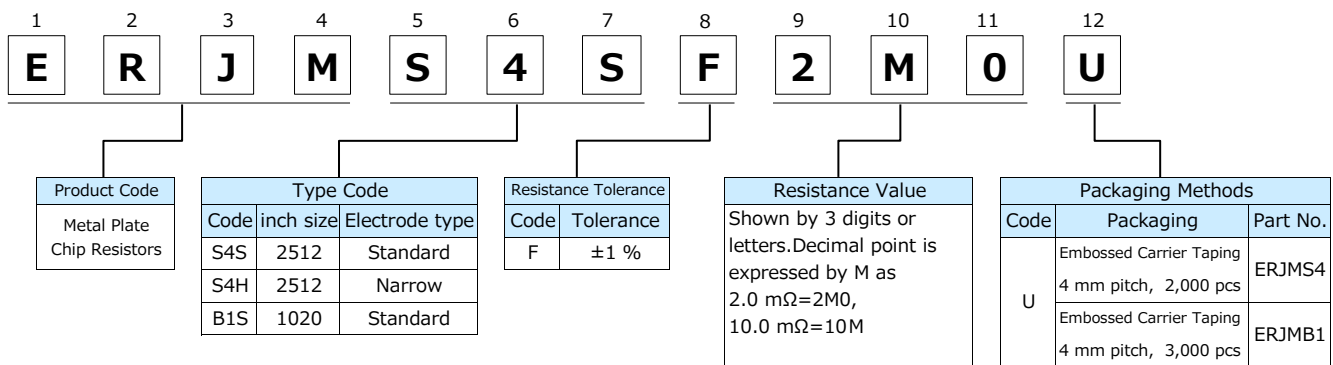

Ratings

Part No. (inch size)	Power Rating at 70 °C (W)	Resistance Range (mΩ)	Resistance Tolerance (%)	T.C.R. (×10 ⁻⁶ /K)	Category Temperature Range (°C)	Terminal temp. upper limit (°C)	AEC-Q200 Grade
ERJMS4S (2512)	3	1, 2, 3, 4	F : ±1	±75	-65 to +170	130	Grade 0
ERJMS4H (2512)	3	5, 6	F : ±1	±75	-65 to +170	130	Grade 0
	2	7, 8, 9, 10	F : ±1	±75	-65 to +170	100	
ERJMB1S (1020)	2	1, 2, 3, 4, 5	F : ±1	±75	-65 to +170	130	Grade 0

* Please contact us when resistors of irregular series are needed.

Power Derating Curve

If the terminal temperature of the resistor is more than terminal temperature upper limit value of the rated table, please reduce the rated power according to the Power Derating Curve shown in the figure on the right.

<Supplemented>

In the case of the temperature measurement of the terminal portion of the resistor, Please perform under the following conditions.

- 1) Terminal temperature measurement, please apply the temperature of the higher of either the left or right electrode upper surface of the resistor.
- 2) Please measure the temperature of the resistor in the land pattern printed of circuit board and plan to use by real conditions.

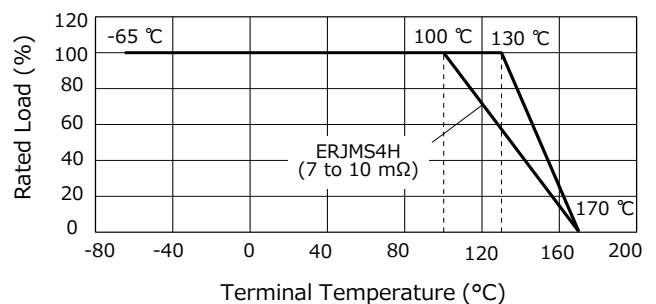

Construction

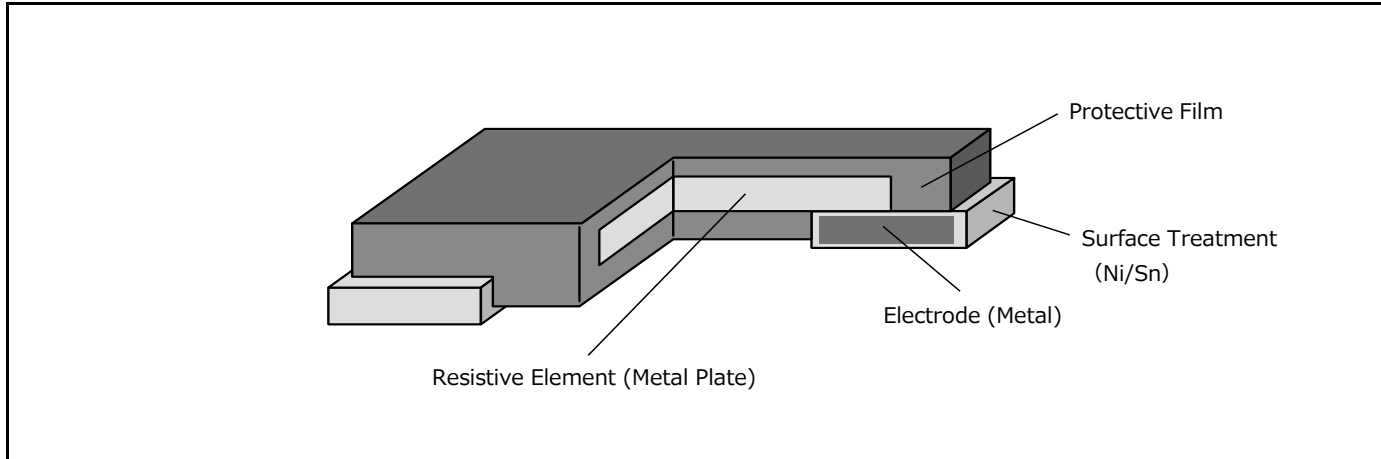

Dimensions in mm (not to scale), Recommended Land Pattern

● ERJMS4S/ERJMS4H

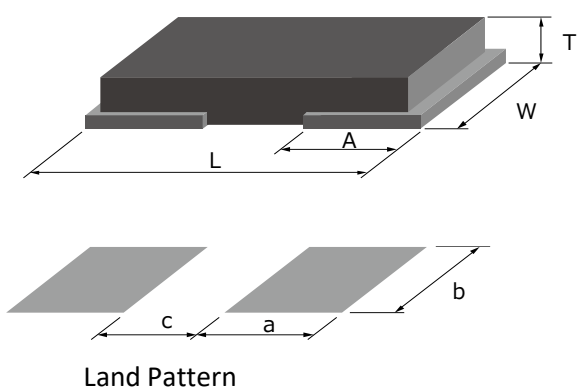

● ERJMB1S

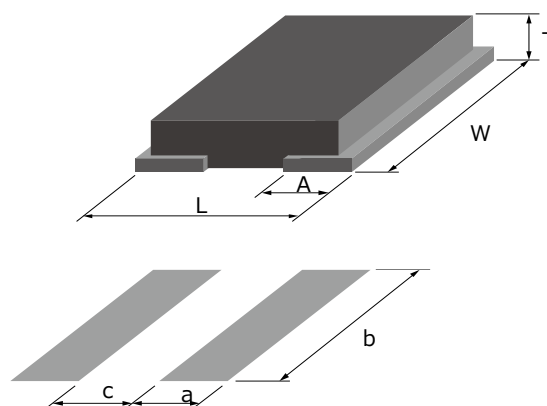

Part No.	Dimensions (mm)				Recommended Land Pattern (mm)			Mass (Weight) (g/1000 pcs)
	L	W	A	T	a	b	c	
ERJMS4S	6.40±0.25	3.20±0.25	2.20±0.25	1.20±0.15	2.7	3.4	2.0	120
ERJMS4H	6.40±0.25	3.20±0.25	1.25±0.25	1.20±0.15	1.7	3.4	4.0	115
ERJMB1S	2.55±0.25	5.00±0.25	0.68 +0.15/-0.20	0.90±0.15	1.15	5.5	1.1	40

Typical Temp. dependence of electrical resistance

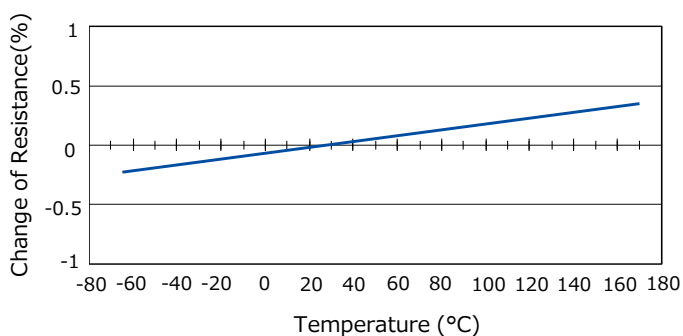

Long-term stability

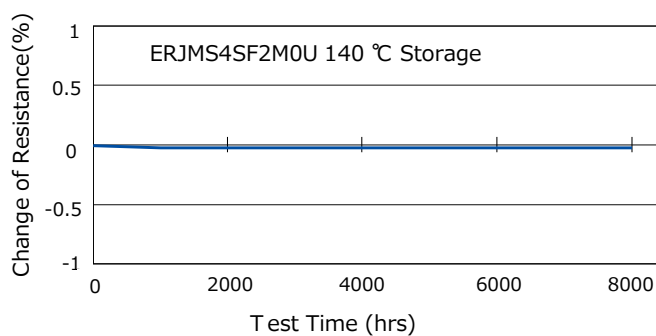

Maximum pulse energy respectively pulse power for continuous operation

Reference Data
 Condition : Room Temperature, OFF : 10 s, 1000 cycle, Wave form : Square
 Change of Resistance = ±1 %

● ERJMS4S/ERJMS4H

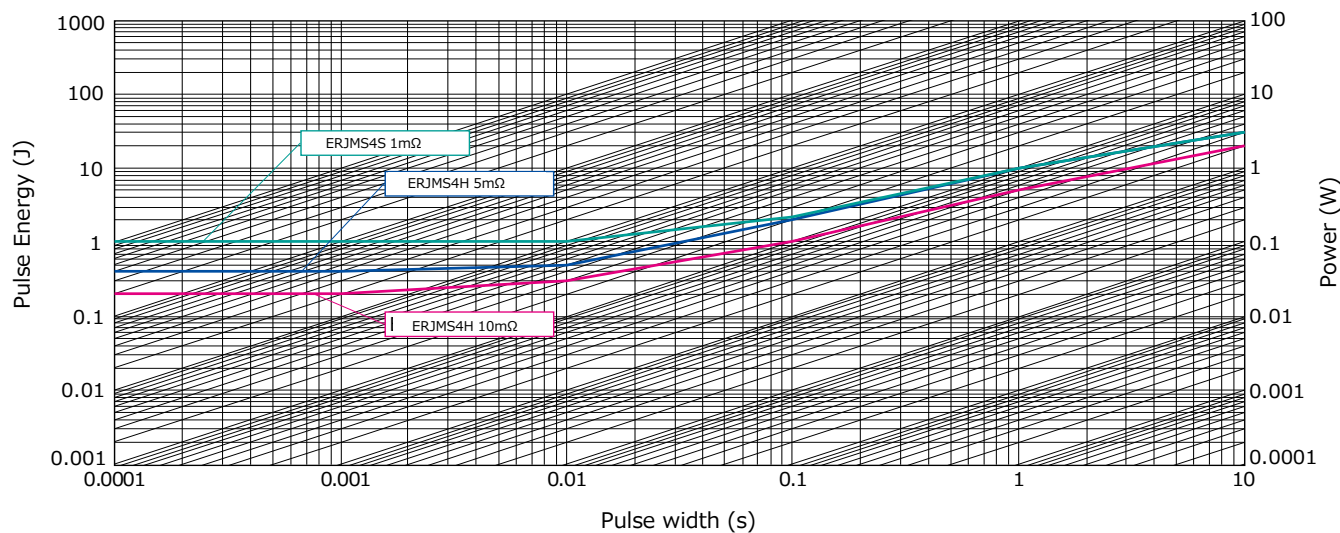

● ERJMB1S

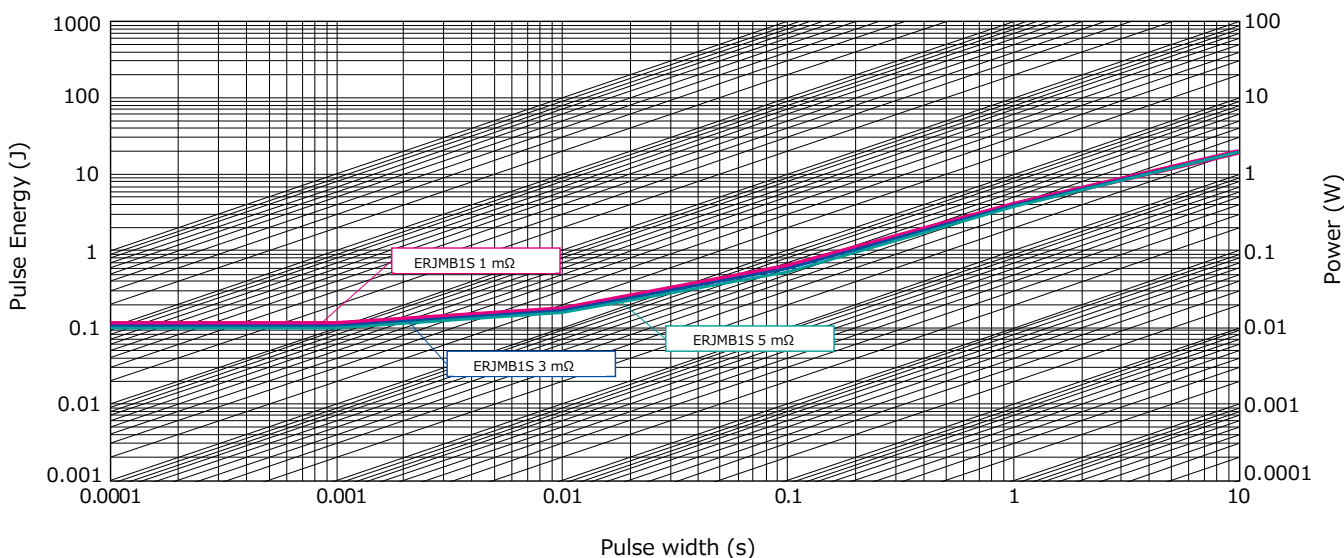

Performance (AEC-Q200)

● ERJMS4S/ERJMS4H

Test Item	Performance Requirements ΔR	Typical value ΔR	Test Condition
Thermal Shock	$\pm 1 \%$	0.20 %	-55 °C / +155 °C, 1000 cycles
Overload	$\pm 0.5 \%$	0.10 %	Rated Power $\times 3$, 5 s
Solderability	> 95% coverage	> 95% coverage	245 °C, 3 s
Resistance to Solvents	No damage	No damage	MIL-STD-202 method 215, 2.1a, 2.1d
Low Temperature Storage and Operation	$\pm 0.5 \%$	0.03 %	-65 °C, 24 h
Resistance to Soldering Heat	$\pm 0.5 \%$	0.10 %	MIL-STD-202 method 210 (260 °C, 10 s)
Moisture Resistance	$\pm 0.5 \%$	0.10 %	MIL-STD-202 method 106
Shock	$\pm 0.5 \%$	0.10 %	MIL-STD-202 method 213-A
Vibration, High Frequency	$\pm 0.5 \%$	0.05 %	10 to 2000 (Hz)
Life	$\pm 1 \%$	0.30 %	70 °C, Rated Power, 2000 h
Storage Life at Elevated Temperature	$\pm 1 \%$	0.30 %	170 °C, 2000 h
High Temperature Characteristics	$\pm 0.5 \%$	0.05 %	140 °C, 2000 h
Frequency Characteristics	< 5 nH	< 2 nH	Inductance

● ERJMB1

Test Item	Performance Requirements ΔR	Typical value ΔR	Test Condition
Thermal Shock	$\pm 1 \%$	0.30 %	-55 °C / +155 °C, 1000 cycles
Overload	$\pm 1 \%$	0.30 %	Rated Power $\times 2.5$, 5 s
Solderability	> 95% coverage	> 95% coverage	245 °C, 3 s
Resistance to Solvents	No damage	No damage	MIL-STD-202 method 215, 2.1a, 2.1d
Low Temperature Storage and Operation	$\pm 0.5 \%$	0.03 %	-65 °C, 24 h
Resistance to Soldering Heat	$\pm 0.5 \%$	0.10 %	MIL-STD-202 method 210 (260 °C, 10 s)
Moisture Resistance	$\pm 0.5 \%$	0.10 %	MIL-STD-202 method 106
Shock	$\pm 0.5 \%$	0.10 %	MIL-STD-202 method 213-A
Vibration, High Frequency	$\pm 0.5 \%$	0.05 %	10 to 2000 (Hz)
Life	$\pm 1 \%$	0.30 %	70 °C, Rated Power, 2000 h
Storage Life at Elevated Temperature	$\pm 1 \%$	0.30 %	170 °C, 2000 h
High Temperature Characteristics	$\pm 0.5 \%$	0.05 %	140 °C, 2000 h
Frequency Characteristics	< 5 nH	< 2 nH	Inductance

Temperature Rise

● ERJMS4HF5M0U

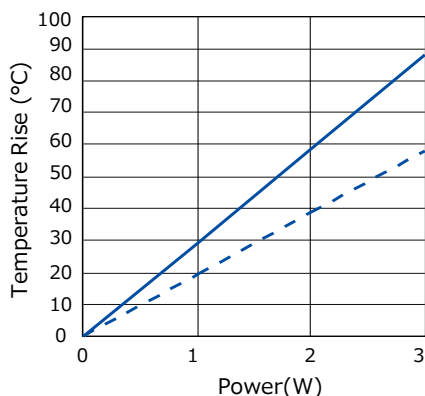

● ERJMB1SF3M0U

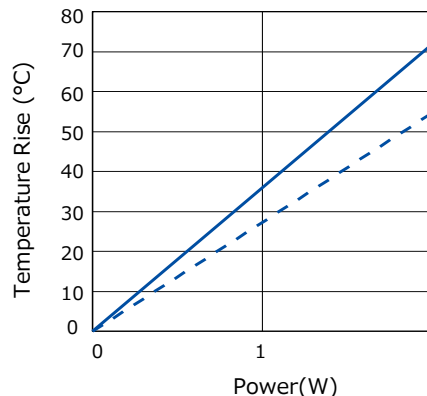

- ① ———— <Condition>
- ② - - - - Base material : FR-4 (t 1.6 mm)
Copper Thickness : 70 μ m, Two layer

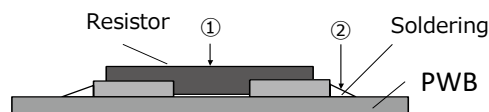

Sense terminal-Layout

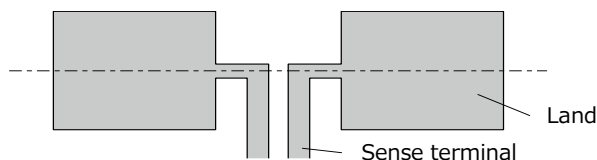

High Power Chip Resistors / Wide Terminal Type



Series: ERJ A1, B1, B2, B3

Features

- High solder-joint reliability by wide terminal construction
- Excellent heat dissipation characteristics by wide terminal construction
- AEC-Q200 compliant
- RoHS compliant

Recommended Applications

- Automotive electronic circuits including ECUs (Electrical control unit), anti-lock braking systems and air-bag systems.
- Current sensing for power supply circuits in a variety of equipment.

■ As for Packaging Methods, Land Pattern, Soldering Conditions and Safety Precautions, Please see Data Files

Explanation of Part Numbers

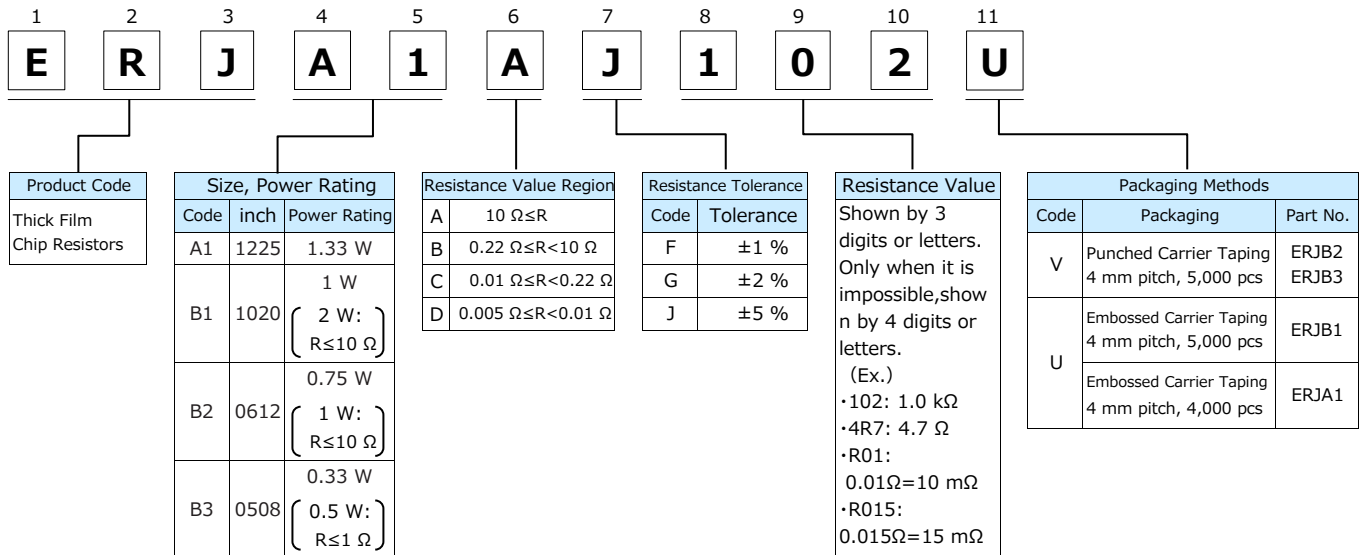

Ratings

Part No. (inch size)	Power Rating at 70 °C ⁽¹⁾ (W)	Limiting Element Voltage ⁽²⁾ (V)	Maximum Overload Voltage ⁽³⁾ (V)	Resistance Tolerance (%)	Resistance Range (Ω)	T.C.R. (×10 ⁻⁶ /K)	Category Temperature Range (°C)	AEC- Q200 Grade			
ERJA1 (1225)	1.33	200	400	±1	100 m to 10 k (E24)	±100	-55 to +155	Grade 0			
				±2, ±5	10 m to 10 k (E24)	R < 100mΩ : ±350 100mΩ ≤ R : ±200					
ERJB1 (1020)	1 2(R ≤ 10 Ω)	200	400	±1	10 m to 10 k (E24)	R < 22mΩ : 0 to +350 22mΩ ≤ R < 47mΩ : 0 to +200 47mΩ ≤ R < 100mΩ : 0 to +150 100mΩ ≤ R : ±100		-55 to +155	Grade 0		
				±2, ±5	10 m to 10 k (E24)	R < 22mΩ : 0 to +350 22mΩ ≤ R < 100mΩ : 0 to +200 100mΩ ≤ R : ±200					
ERJB2 (0612)	0.75 1(R ≤ 10 Ω)	200	400	±1	10 m to 1 M (E24)	R < 22mΩ : 0 to +300 22mΩ ≤ R < 47mΩ : 0 to +200 47mΩ ≤ R < 100mΩ : 0 to +150 100mΩ ≤ R < 220mΩ : 0 to +100 220mΩ ≤ R : ±100			-55 to +155	Grade 0	
				±2	10 m to 1 M (E24)	R < 22mΩ : 0 to +300 22mΩ ≤ R < 47mΩ : 0 to +200 47mΩ ≤ R < 100mΩ : 0 to +150 100mΩ ≤ R < 220mΩ : 0 to +200 220mΩ ≤ R : ±200					
				±5	5 m, 6 m, 7 m, 8 m, 9 m, 10 m to 1 M (E24)	R < 22mΩ : 0 to +300 22mΩ ≤ R < 47mΩ : 0 to +200 47mΩ ≤ R < 100mΩ : 0 to +150 100mΩ ≤ R < 220mΩ : 0 to +200 220mΩ ≤ R : ±200					
ERJB3 (0508)	0.33 0.5(R ≤ 1 Ω)	150	200	±1	20 m to 10 (E24)	R < 47mΩ : 0 to +300 47mΩ ≤ R < 1Ω : 0 to +200 1Ω ≤ R : ±100				-55 to +155	Grade 0
				±2, ±5	20 m to 10 (E24)	R < 47mΩ : 0 to +300 47mΩ ≤ R < 1Ω : 0 to +200 1Ω ≤ R : ±200					

- (1) Use it on the condition that the case temperature is below the upper category temperature.
- (2) Rated Continuous Working Voltage (RCWV) shall be determined from $RCWV = \sqrt{\text{Power Rating} \times \text{Resistance Value}}$, or Limiting Element Voltage listed above, whichever less.
- (3) Overload Test Voltage (OTV) shall be determined from $OTV = \text{Specified Magnification (refer to performance)} \times RCWV$ or Maximum Overload Voltage listed above, whichever less.

Construction (Example : ERJA1 type)

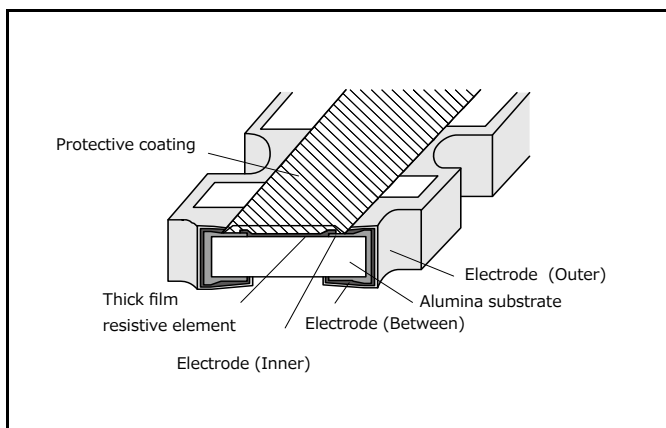

Power Derating Curve

For resistors operated in ambient temperatures above 70 °C, power rating shall be derated in accordance with the figure below.

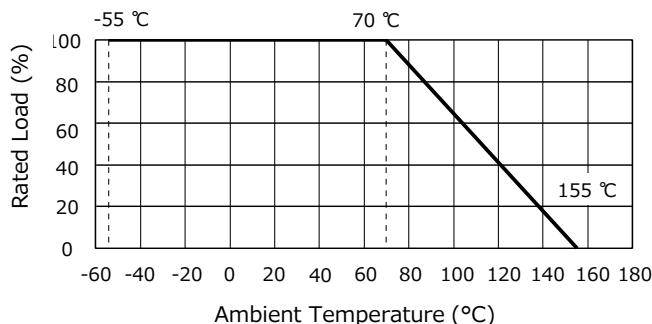

Dimensions in mm (not to scale)

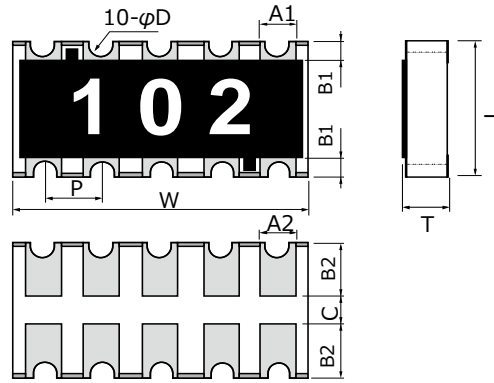

Part No.	Dimensions (mm)					Mass (Weight) (g/1000 pcs)
	L	W	T	A ₁	B ₁	
ERJA1	3.20±0.20	6.40±0.20	0.55±0.10	0.70±0.20	0.45±0.20	40
	A ₂ 0.70±0.20	B ₂ 1.25±0.15	P 1.27±0.10	φD 0.30+0.10/-0.20	C 0.4 min.	

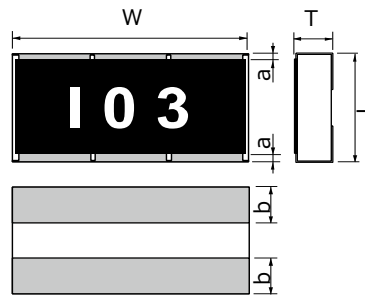

Part No.	Dimensions (mm)					Mass (Weight) (g/1000 pcs)
	L	W	T	a	b	
ERJB1	2.50±0.20	5.00±0.20	0.55±0.20	0.25±0.20	0.90±0.20	27

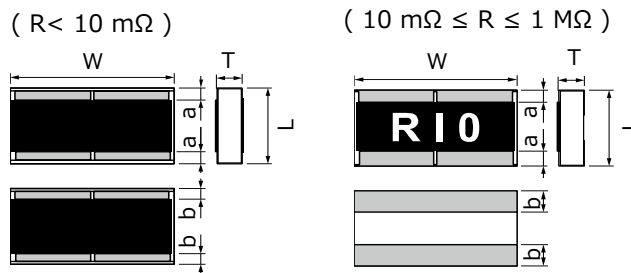

Part No.	Dimensions (mm)					Mass (Weight) (g/1000 pcs)
	L	W	T	a	b	
ERJB2	1.60±0.15	3.20±0.20	0.65±0.15	0.30±0.20	0.30±0.20	11
5 mΩ ≤ R < 10 mΩ			0.55±0.15	0.25±0.20	0.50±0.20	
10 mΩ ≤ R < 220 mΩ						
220 mΩ ≤ R ≤ 1 MΩ						

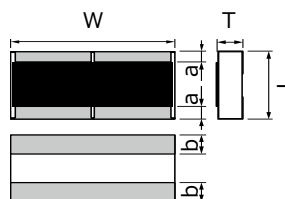

Part No.	Dimensions (mm)					Mass (Weight) (g/1000 pcs)
	L	W	T	a	b	
ERJB3	1.25±0.10	2.00±0.15	0.50±0.10	0.25±0.20	0.40±0.20	4.8

Circuit Configuration

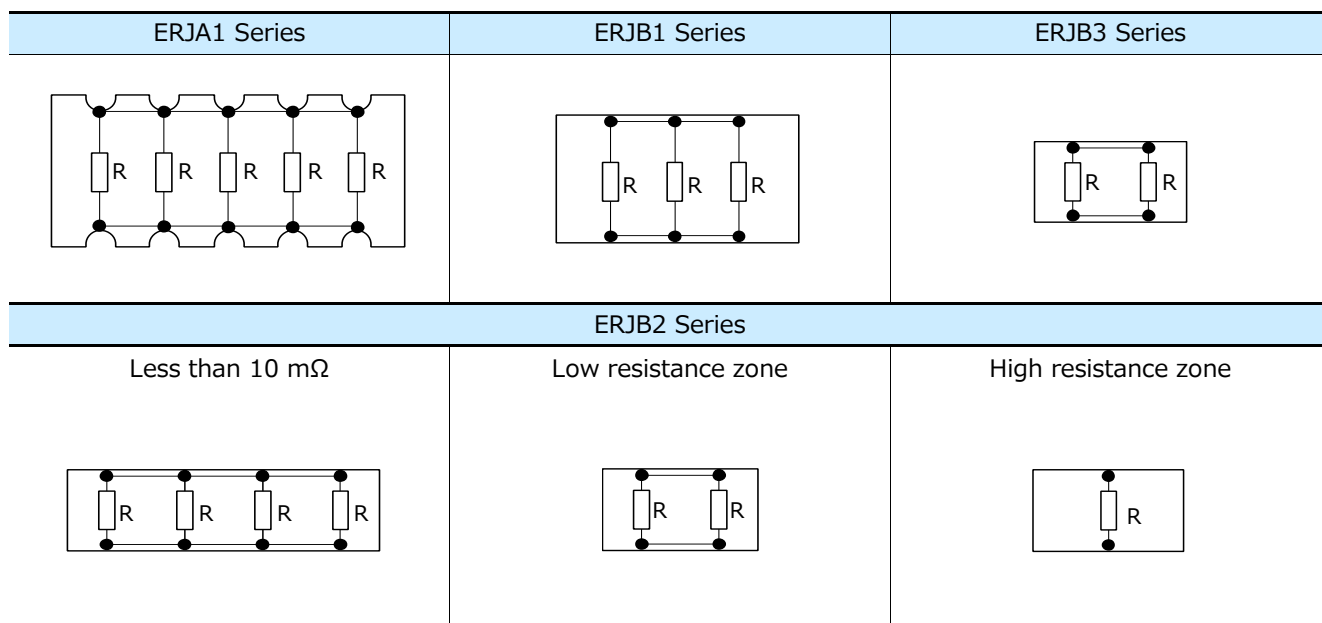

Performance

Test Item	Performance Requirements ΔR	Test Conditions
Resistance	Within Specified Tolerance	20 °C
T. C. R.	Within Specified T. C. R.	+25 °C/+125 °C
Overload	±2 %	ERJA1, ERJB1 (R>10), ERJB3 (R>1) : Rated Voltage× 2.5 , 5 s ERJB2 (R>10) : Rated Voltage× 2.2 , 5 s ERJB1 (R≤10), ERJB2 (R≤10), ERJB3 (R≤1) : Rated Voltage× 2.0 , 5 s
Resistance to Soldering Heat	±1 %	270 °C, 10 s
Rapid Change of Temperature	±2 %	-55 °C (30 min.) / +125 °C(30 min.), 1000 cycles
High Temperature Exposure	±1 %	+155 °C, 1000 h
Damp Heat, Steady State	±1 %	60 °C, 90 % to 95 %RH, 1000 h
Load Life in Humidity	±3 %	60 °C, 90 % to 95 %RH, Rated Voltage, 1.5 h ON / 0.5 h OFF cycle, 1000 h
Endurance at 70 °C	±3 %	70 °C, Rated Voltage, 1.5 h ON / 0.5 h OFF cycle, 1000 h

Low TCR High Power Chip Resistors / Wide Terminal Type

.010

.010

Series: ERJ D1, D2

Features

- Achieved High power and low TCR ($\pm 100 \times 10^{-6}/K$) using wide terminal electrode structure and original material
- Suitable for small size/high power current detection (Low TCR enables high accuracy of current detection)
- High solder-joint reliability by wide terminal construction
- Excellent heat dissipation characteristics by wide terminal construction
- AEC-Q200 compliant
- RoHS compliant

Recommended Applications

- Automotive electronic circuits including ECUs (Electrical control unit), anti-lock breaking systems and air-bag systems.
- Current sensing for power supply circuits in a variety of equipment.

■ As for Packaging Methods, Land Pattern, Soldering Conditions and Safety Precautions, Please see Data Files

Explanation of Part Numbers

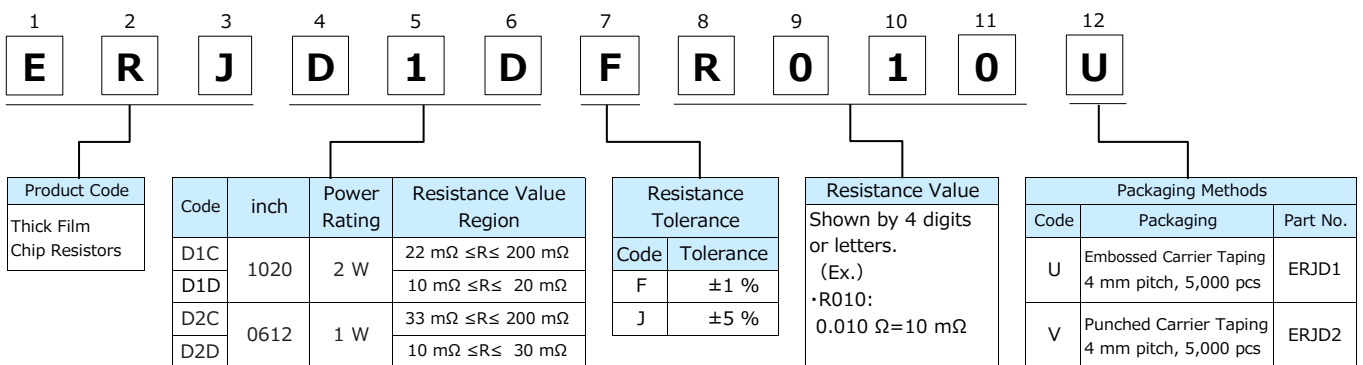

Ratings

Part No. (inch size)	Power Rating at 70 °C ⁽¹⁾ (W)	Resistance Tolerance (%)	Resistance Range (Ω)	T.C.R. ($\times 10^{-6}/K$)	Category Temperature Range (°C)	AEC- Q200 Grade
ERJD1 (1020)	2	±1, ±5	10 m to 200 m (E24)	±100	-55 to +155	Grade 0
ERJD2 (0612)	1	±1, ±5	10 m to 200 m (E24)	±100		

(1) Use it on the condition that the case temperature is below the upper category temperature.

- Please contact us when resistors of irregular series are needed.
- Rated Continuous Working Voltage (RCWV) shall be determined from $RCWV = \sqrt{\text{Power Rating} \times \text{Resistance Value}}$.
- Overload Test Voltage (OTV) shall be determined from $OTV = \text{Specified Magnification (refer to performance)} \times RCWV$.

Power Derating Curve

For resistors operated in ambient temperatures above 70 °C, power rating shall be derated in accordance with the figure on the right.

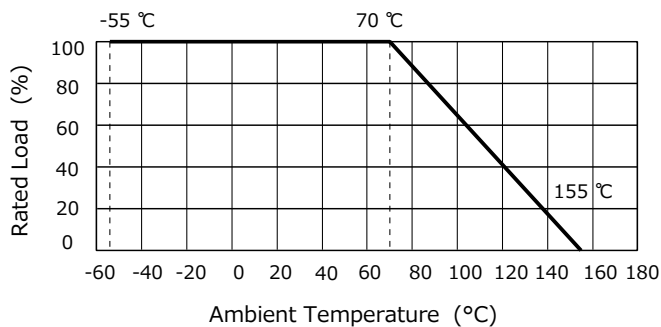

Construction

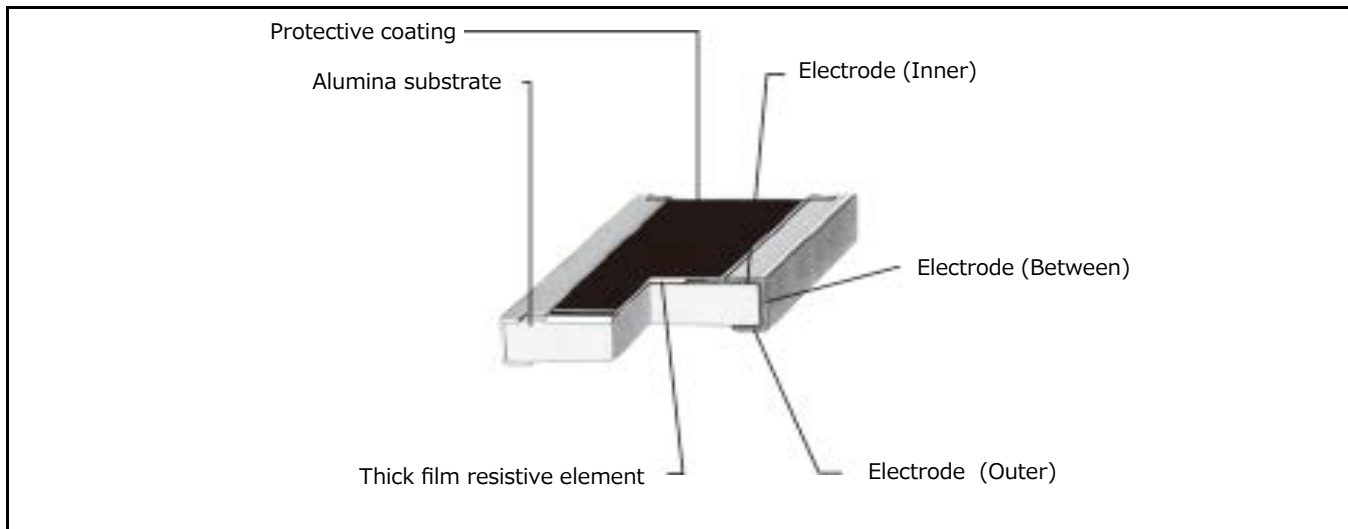

Dimensions in mm (not to scale)

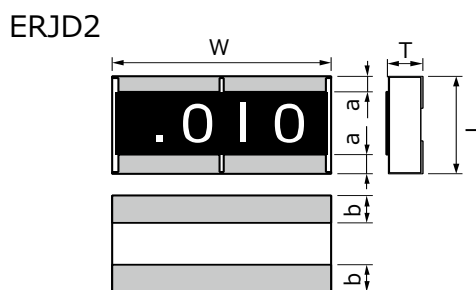
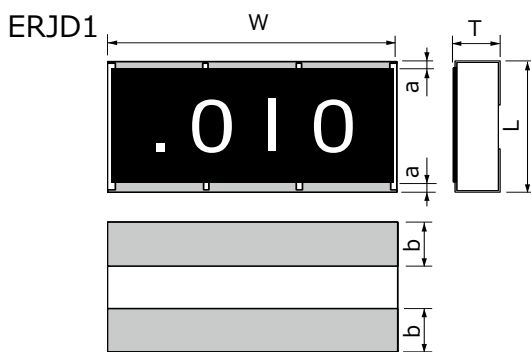

Part No.	Dimensions (mm)					Mass (Weight) (g/1000 pcs)
	L	W	T	a	b	
ERJD1	2.50±0.20	5.00±0.20	0.60±0.20	0.30±0.20	0.90±0.20	27
ERJD2	1.60±0.15	3.20±0.20	0.65±0.15	0.30±0.20	0.50±0.20	11

Circuit Configuration



Performance

Test Item	Performance Requirements ΔR	Test Conditions
Resistance	Within Specified Tolerance	20 °C
T. C. R.	Within Specified T. C. R.	+25 °C/+125 °C
Overload	±2 %	Rated Voltage × 2.0 , 5 s
Resistance to Soldering Heat	±1 %	270 °C, 10 s
Rapid Change of Temperature	±2 %	-55 °C (30 min.) / +125 °C(30 min.), 1000 cycles
High Temperature Exposure	±1 %	+155 °C, 1000 h
Damp Heat, Steady State	±1 %	60 °C, 90 % to 95 %RH, 1000 h
Load Life in Humidity	±3 %	60 °C, 90 % to 95 %RH, Rated Voltage, 1.5 h ON / 0.5 h OFF cycle, 1000 h
Endurance at 70 °C	±3 %	70 °C, Rated Voltage, 1.5 h ON / 0.5 h OFF cycle, 1000 h

Anti-Surge Thick Film Chip Resistors



Series: ERJ PA2, P03, PA3, P06, P08, P14

Features

- ESD surge characteristics superior to standard metal film resistors
- High reliability...Metal glaze thick film resistive element and three layers of electrodes
- Suitable for both reflow and flow soldering
- High power... 0.20 W : 0402 inch / 1005 mm size (ERJPA2), 0603 inch / 1608 mm size (ERJP03)
0.25 W : 0603 inch / 1608 mm size (ERJPA3)
0.50 W : 0805 inch / 2012 mm size (ERJP06), 1210 inch / 3225 mm size (ERJP14)
0.66 W : 1206 inch / 3216 mm size (ERJP08)
- Reference Standard ... IEC 60115-8, JIS C 5201-8, JEITA RC-2134C
- AEC-Q200 compliant
- RoHS compliant

■ **As for Packaging Methods, Land Pattern, Soldering Conditions and Safety Precautions,**
Please see Data Files

Explanation of Part Numbers

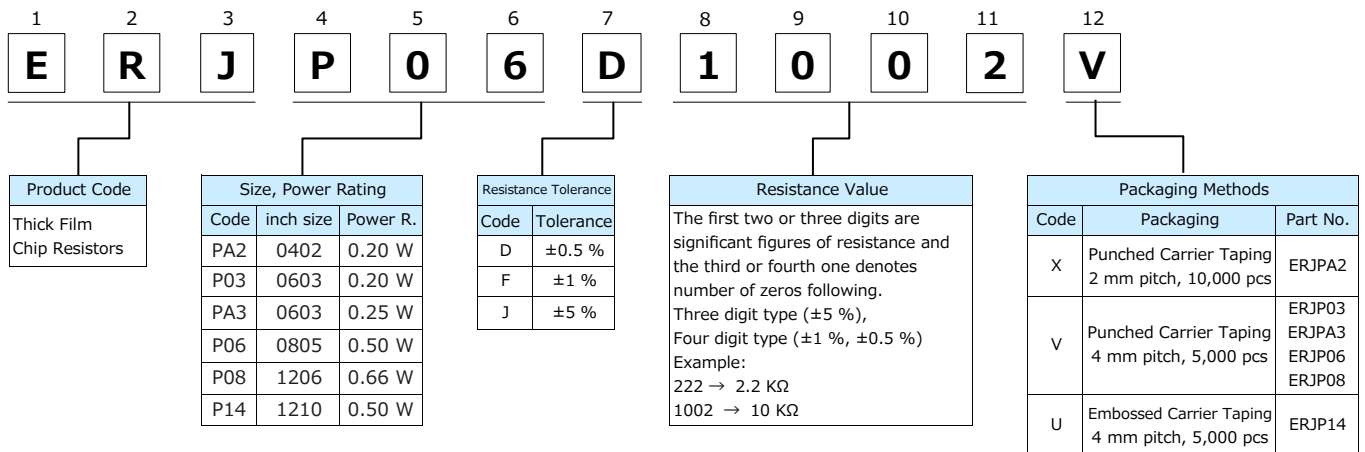

Ratings

Part No. (inch size)	Power Rating at 70 °C ⁽¹⁾ (W)	Limiting Element Voltage ⁽²⁾ (V)	Maximum Overload Voltage ⁽³⁾ (V)	Resistance Tolerance (%)	Resistance Range (Ω)	T.C.R. (×10 ⁻⁶ /K)	Category Temperature Range (°C)	AEC-Q200 Grade			
ERJPA2 (0402)	0.20	50	100	±0.5, ±1	10 to 1 M (E24, E96)	±100	-55 ~ +155	Grade 1			
				±5	10 to 1 M (E24)	±200					
ERJP03 (0603)	0.20	150	200	±0.5	10 to 1 M (E24, E96)	±150		-55 ~ +155	Grade 0		
				±1	10 to 1 M (E24, E96)	±200					
				±5	1 to 1 M (E24)	R<10Ω : -150 to +400 10Ω≤R : ±200					
ERJPA3 (0603)	0.25 (105 °C)	150	200	±0.5, ±1	10 to 1 M (E24, E96)	±100			-55 ~ +155	Grade 0	
				±5	1 to 1.5 M (E24)	±200					
ERJP06 (0805)	0.50	400	600	±0.5, ±1	10 to 1 M (E24, E96)	R<33Ω : ±300 33Ω≤R : ±100				-55 ~ +155	Grade 0
				±5	1 to 3.3 M (E24)	R<10Ω : -100 to +600 10Ω≤R<33Ω : ±300 33Ω≤R : ±200					
				±0.5, ±1	10 to 1 M (E24, E96)	±100					
ERJP08 (1206)	0.66	500	1000	±0.5, ±1	10 to 1 M (E24, E96)	±100	-55 ~ +155				Grade 0
				±5	1 to 10 M (E24)	R<10Ω : -100 to +600 10Ω≤R : ±200					
ERJP14 (1210)	0.50	200	400	±0.5, ±1	10 to 1 M (E24, E96)	±100		-55 ~ +155			Grade 0
				±5	1 to 1 M (E24)	R<10Ω : -100 to +600 10Ω≤R : ±200					

- (1) Use it on the condition that the case temperature is below the upper category temperature.
- (2) Rated Continuous Working Voltage (RCWV) shall be determined from $RCWV = \sqrt{\text{Power Rating} \times \text{Resistance Value}}$, or Limiting Element Voltage listed above, whichever less.
- (3) Overload Test Voltage (OTV) shall be determined from $OTV = \text{Specified Magnification (refer to performance)} \times RCWV$ or Maximum Overload Voltage listed above, whichever less.

Power Derating Curve

For resistors operated in rated temperatures above 70 °C or 105 °C, power rating shall be derated in accordance with the figure on the right.
 * When the temperature of ERJP14 is 155 °C or less, the derating start temperature can be changed to 125 °C. (See the dotted line)

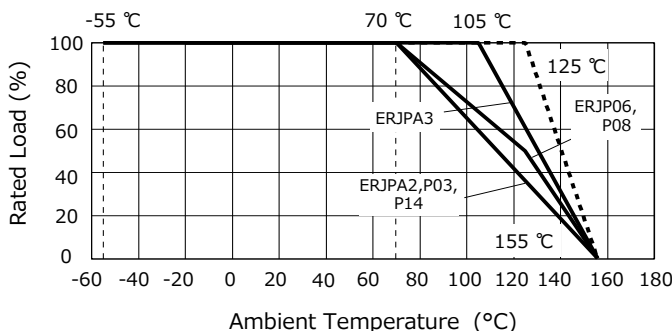

Construction

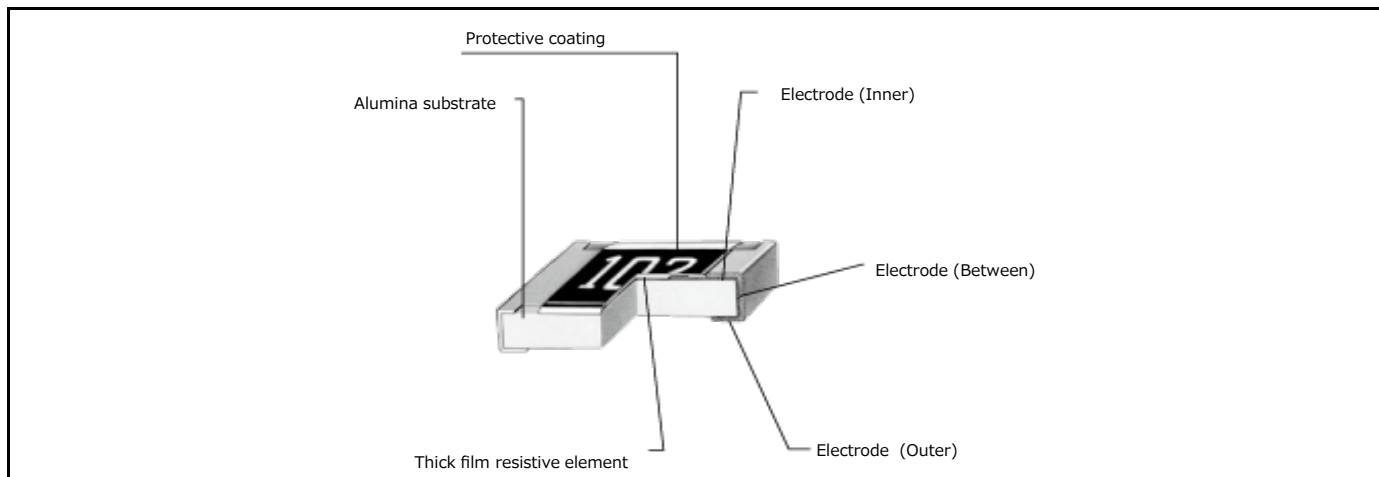

Dimensions in mm (not to scale)

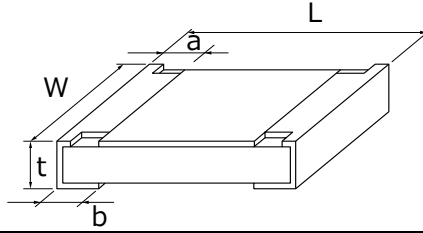

Part No.	Dimensions (mm)					Mass (Weight) (g/1000 pcs)
	L	W	a	b	t	
ERJPA2	1.00±0.05	0.50±0.05	0.20±0.15	0.25±0.05	0.35±0.05	0.8
ERJP03	1.60±0.15	0.80+0.15/-0.05	0.15+0.15/-0.10	0.30±0.15	0.45±0.10	2
ERJPA3	1.60±0.15	0.80+0.15/-0.05	0.15+0.15/-0.10	0.25±0.10	0.45±0.10	2
ERJP06	2.00±0.20	1.25±0.10	0.25±0.20	0.40±0.20	0.60±0.10	4
ERJP08	3.20+0.05/-0.20	1.60+0.05/-0.15	0.40±0.20	0.50±0.20	0.60±0.10	10
ERJP14	3.20±0.20	2.50±0.20	0.35±0.20	0.50±0.20	0.60±0.10	16

ESD Characteristic

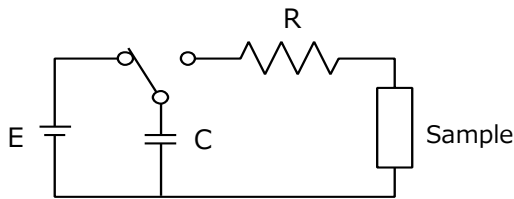

Size (inch)	0402	0603, 0805, 1206, 1210
R	1.5 kΩ	R=0 Ω(≤1.5 kΩ) / 150 Ω(> 1.5 kΩ)
C	100 pF	150 pF
E	±1 kV	±3 kV

— Anti-Surge Thick Film Chip Resistors (ERJP Series)
 - - - Thick Film Chip Resistors (ERJ Series)

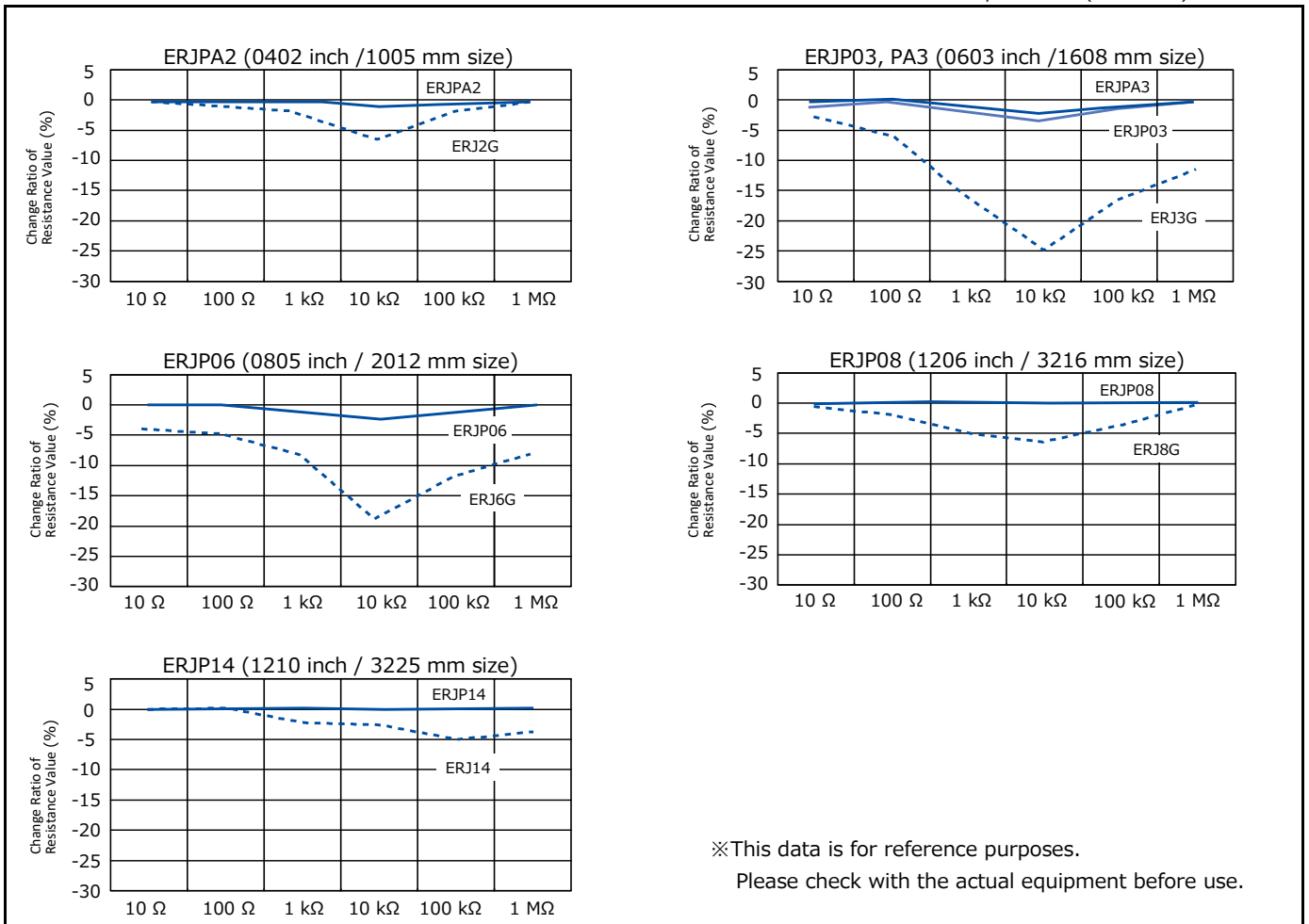

Performance

Test Item	Performance Requirements ΔR	Test Conditions
Resistance	Within Specified Tolerance	20 °C
T. C. R.	Within Specified T. C. R.	+25 °C/+155 °C (ERJPA2 : +125 °C)
Overload	± 2 % Only when it is ERJP03 (D), P14 (D) : ± 0.5 %	ERJP06 : Rated Voltage \times 1.77, 5 s ERJPA2, ERJPA3, ERJP08 : Rated Voltage \times 2.0 , 5 s ERJP03, ERJP14 : Rated Voltage \times 2.5 , 5 s
Resistance to Soldering Heat	D : ± 0.5 %, F, J : ± 1 %	270 °C, 10 s
Rapid Change of Temperature	± 1 %	-55 °C (30min.) / +155 °C (ERJPA2 : +125 °C) (30min.), 100 cycles
High Temperature Exposure	± 1 %	+155 °C, 1000 h
Damp Heat, Steady State	± 1 %	60 °C, 90 % to 95 %RH, 1000 h
Load Life in Humidity	± 3 % Only when it is ERJP03 (D), P14 (D) : ± 1 %	60 °C, 90 % to 95 %RH, Rated Voltage, 1.5 h ON / 0.5 h OFF cycle, 1000 h
Endurance at 70 °C (ERJPA3 : 105 °C)	± 3 % Only when it is ERJP03 (D), P14 (D) : ± 1 %	70 °C (ERJPA3 : +105 °C), Rated Voltage, 1.5 h ON / 0.5 h OFF cycle, 1000 h



Anti-Pulse Thick Film Chip Resistors

Series: **ERJ T06, T08, T14**
ERJ T14L

Features

- Anti-Pulse characteristics
High pulse characteristics achieved by the optimized trimming specifications (ERJT06, T08, T14)
- Further high pulse characteristics achieved by trimming-less specifications (ERJT14L)
- High reliability ……Metal glaze thick film resistive element and three layers of electrodes
- Suitable for both reflow and flow soldering
- High power ……0.25 W : 0805 inch /2012 mm size (ERJT06)
0.33 W : 1206 inch /3216 mm size (ERJT08)
0.50 W : 1210 inch /3225 mm size (ERJT14, ERJT14L)
- Reference Standard … IEC 60115-8, JIS C 5201-8, JEITA RC-2134C
- AEC-Q200 compliant
- RoHS compliant

■ **As for Packaging Methods, Land Pattern, Soldering Conditions and Safety Precautions,**
Please see Data Files

Explanation of Part Numbers

● Series ERJT06, T08, T14

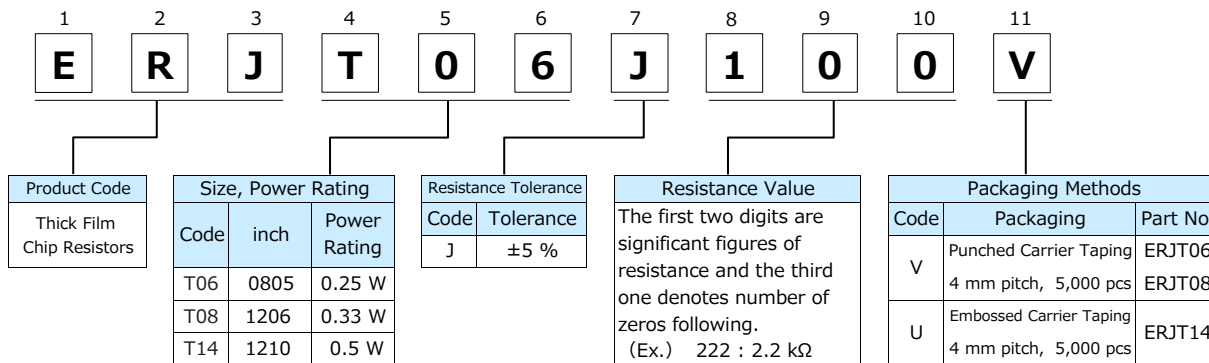

● Series ERJT14L

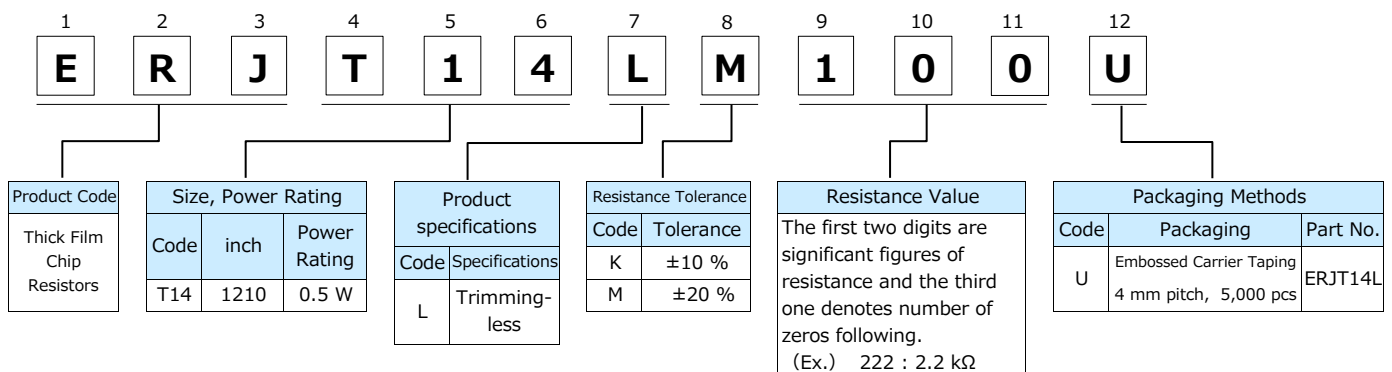

* Please contact us for 0805 (inch) and 1206 (inch) size trimming-less types.

Ratings

Part No. (inch size)	Power Rating at 70 °C ⁽¹⁾ (W)	Limiting Element Voltage ⁽²⁾ (V)	Maximum Overload Voltage ⁽³⁾ (V)	Resistance Tolerance (%)	Resistance Range (Ω)	T.C.R. (×10 ⁻⁶ /K)	Category Temperature Range (°C)	AEC- Q200 Grade
ERJT06 (0805)	0.25	150	200	±5	1 to 1 M (E24)	R<10 Ω : -100 to +600 10 Ω≤R<33 Ω : ±300 33 Ω≤R : ±200	-55 to +155	Grade 0
ERJT08 (1206)	0.33	200	400	±5	1 to 1 M (E24)	R<10 Ω : -100 to +600 10 Ω≤R : ±200	-55 to +155	Grade 0
ERJT14 (1210)	0.50	200	400	±5	1 to 1 M (E24)	R<10 Ω : -100 to +600 10 Ω≤R : ±200	-55 to +155	Grade 0
ERJT14L (1210)	0.50	200	400	±10 ±20	1 to 1 M (E12)	R<10 Ω : -100 to +600 10 Ω≤R : ±200	-55 to +155	Grade 0

- (1) Use it on the condition that the case temperature is below the upper category temperature.
- (2) Rated Continuous Working Voltage (RCWV) shall be determined from $RCWV = \sqrt{\text{Power Rating} \times \text{Resistance Value}}$, or Limiting Element Voltage listed above, whichever less.
- (3) Overload Test Voltage (OTV) shall be determined from $OTV = \text{Specified Magnification (refer to performance)} \times RCWV$ or Maximum Overload Voltage listed above, whichever less.

Power Derating Curve

For resistors operated in ambient temperatures above 70 °C, power rating shall be derated in accordance with the figure on the right.

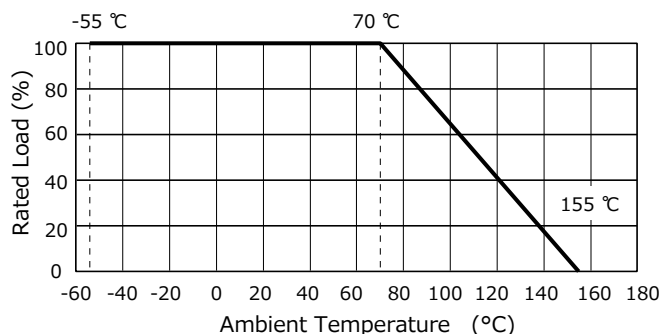

Construction

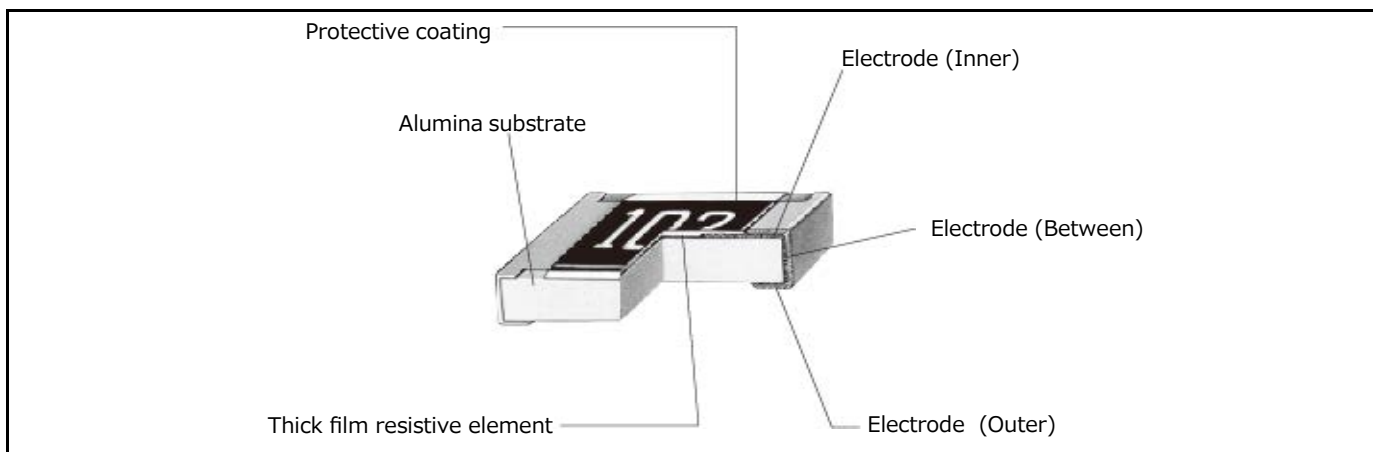

Dimensions in mm (not to scale)

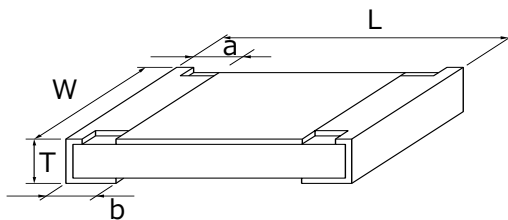

Part No.	Dimensions (mm)					Mass (Weight) (g/1000 pcs)
	L	W	a	b	T	
ERJT06	2.00±0.20	1.25±0.10	0.25±0.20	0.40±0.20	0.60±0.10	4
ERJT08	3.20+0.05/-0.20	1.60+0.05/-0.15	0.40±0.20	0.50±0.20	0.60±0.10	10
ERJT14 ERJT14L	3.20±0.20	2.50±0.20	0.35±0.20	0.50±0.20	0.60±0.10	16

Limiting Power Curve

- In rush pulse Characteristic

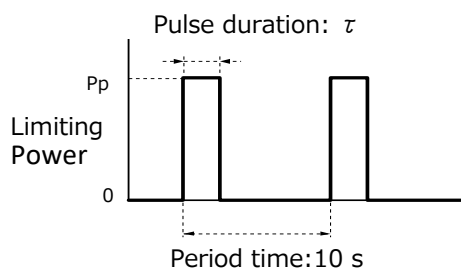

Test cycle : 1000 cycles
 Spec : Resistance value = within $\pm 5\%$

- ▲ : Anti-Pulse Thick Film Chip Resistors (Series ERJT14L)
- : Anti-Pulse Thick Film Chip Resistors (Series ERJT)
- : Thick Film Chip Resistors (Series ERJ : 1 Ω)

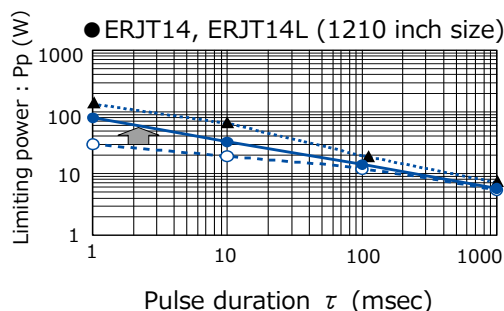
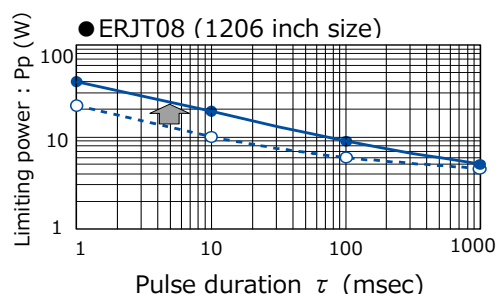
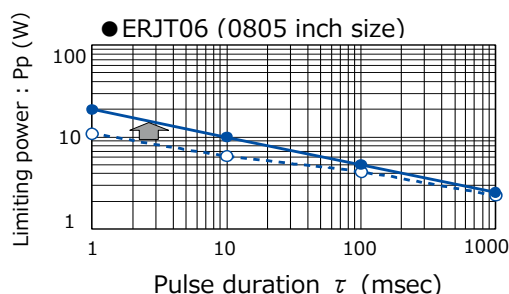

※ This data is for reference purposes.

Please check with the actual equipment before use.

※ Please contact us for 0805 (inch) and 1206 (inch) size trimming-less types.

Performance

Test Item	Performance Requirements ΔR	Test Conditions
Resistance	Within Specified Tolerance	20 °C
T. C. R.	Within Specified T. C. R.	+25 °C/+155 °C
Overload	$\pm 2\%$	Rated Voltage \times 2.5, 5 s
Resistance to Soldering Heat	$\pm 1\%$	270 °C \pm 3 °C, 10 s \pm 1 s
Rapid Change of Temperature	$\pm 1\%$	-55 °C (30 min.) / +155 °C (30 min.), 100 cycles
High Temperature Exposure	$\pm 1\%$	+155 °C, 1000 h
Damp Heat, Steady State	$\pm 1\%$	60 °C \pm 2 °C, 90 % to 95 %RH, 1000 h
Load Life in Humidity	$\pm 3\%$	60 °C \pm 2 °C, 90 % to 95 %RH, Rated Voltage , 1.5 h ON / 0.5 h OFF cycle, 1000 h
Endurance at 70 °C	$\pm 3\%$	70 °C \pm 2 °C, Rated Voltage , 1.5 h ON / 0.5 h OFF cycle, 1000 h

Anti-Sulfurated Thick Film Chip Resistors



ERJ S (Au-based inner electrode type)

Series: ERJ S02, S03, S06, S08, S14, S12, S1D, S1T

ERJ U (Ag-Pd-based inner electrode type)

Series: ERJ U0X, U01, U02, U03, U06, U08, U14, U12, U1D, U1T, U6S, U6Q

Features

- High resistance to sulfurization achieved by adopting an Au-based inner electrode (Series ERJS) and Ag-Pd-based inner electrode (Series ERJU)
- High reliability...Metal glaze thick film resistive element and three layers of electrodes
- Suitable for both reflow and flow soldering
- Low Resistance type ...Series ERJU6S, U6Q : 0.1 Ω to 1 Ω
- Reference Standard ... IEC 60115-8, JIS C 5201-8, JEITA RC-2134C
- AEC-Q200 compliant (except ERJU0X, ERJU01)
- RoHS compliant

■ **As for Packaging Methods, Land Pattern, Soldering Conditions and Safety Precautions,** Please see Data Files

Explanation of Part Numbers

- Series ERJS02 to ERJS1T, ERJU0X to ERJU1T

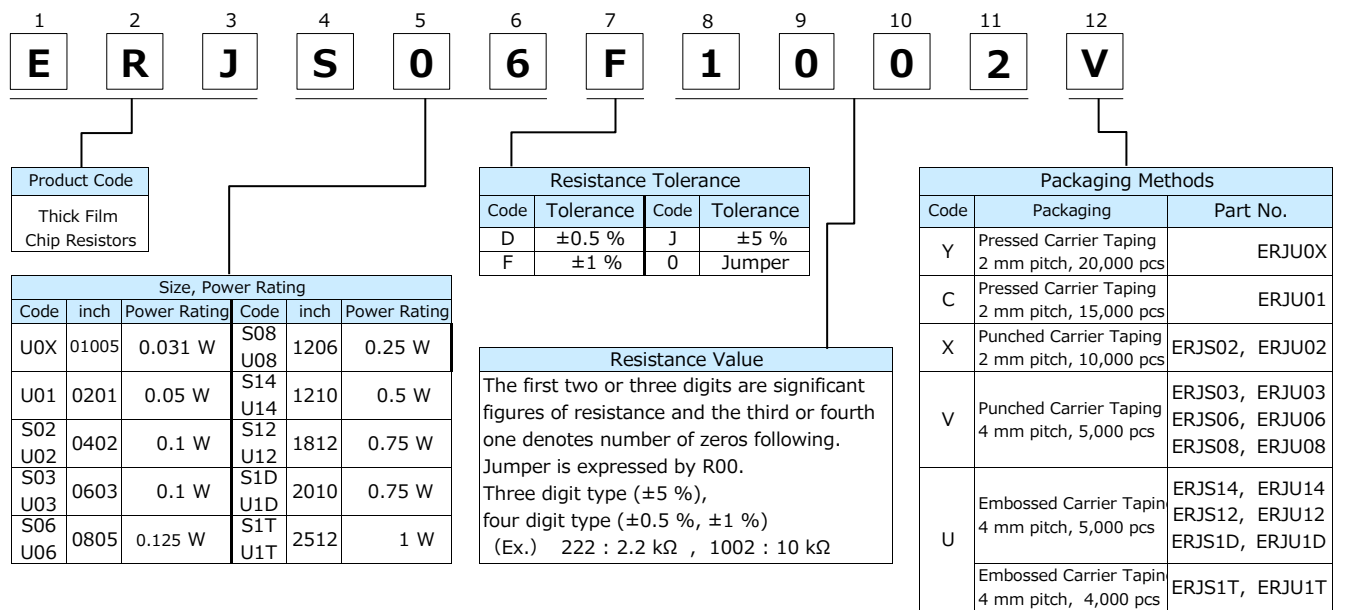

- Series ERJU6S, U6Q

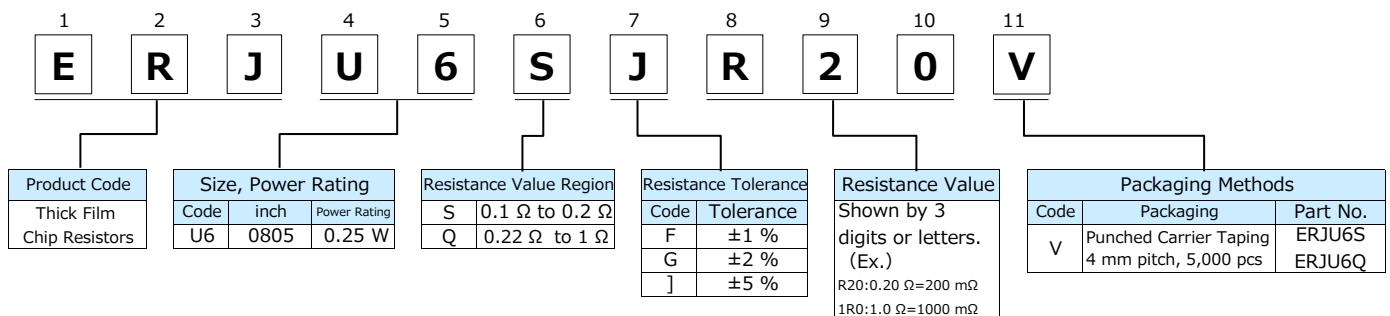

Ratings

Part No. (inch size)	Power Rating at 70 °C ⁽¹⁾ (W)	Limiting Element Voltage ⁽²⁾ (V)	Maximum Overload Voltage ⁽³⁾ (V)	Resistance Tolerance (%)	Resistance Range (Ω)	T.C.R. (×10 ⁻⁶ /K)	Category Temperature Range (°C)	AEC- Q200 Grade
ERJU0X (01005)	0.031	15	30	±1	10 to 1 M (E24, E96)	R<10 Ω : -100 to +600 10 Ω≤R<100 Ω : ±300 100 Ω≤R : ±200	-55 to +125	-
ERJU01 (0201)	0.05	25	50	±1	10 to 1 M (E24, E96)	R<10 Ω : -100 to +600	-55 to +125	-
				±5	1 to 1 M (E24)			
ERJS02 ERJU02 (0402)	0.1	50	100	±0.5, ±1	1 to 1 M (E24, E96)	10 Ω to 1 MΩ : ±200	-55 to +155	Grade 0
				±5	1 to 3.3 M (E24)	1 MΩ<R : -400 to +150		
ERJS03 ERJU03 (0603)	0.1	75	150	±0.5, ±1	1 to 1 M (E24, E96)	R<10 Ω : -100 to +600	-55 to +155	Grade 0
				±5	1 to 10 M (E24)			
ERJS06 ERJU06 (0805)	0.125	150	200	±0.5, ±1	1 to 1 M (E24, E96)	R<10 Ω : -100 to +600	-55 to +155	Grade 0
				±5	1 to 10 M (E24)			
ERJS08 ERJU08 (1206)	0.25	200	400	±0.5, ±1	1 to 1 M (E24, E96)	10 Ω to 1 MΩ : ±200 (± 5 %) ±100 (±0.5 %, ±1 %)	-55 to +155	Grade 0
				±5	1 to 10 M (E24)			
ERJS14 ERJU14 (1210)	0.5	200	400	±0.5, ±1	1 to 1 M (E24, E96)	1 MΩ<R : -400 to +150	-55 to +155	Grade 0
				±5	1 to 10 M (E24)			
ERJS12 ERJU12 (1812)	0.75	200	500	±0.5, ±1	1 to 1 M (E24, E96)	1 MΩ<R : -400 to +150	-55 to +155	Grade 0
				±5	1 to 10 M (E24)			
ERJS1D ERJU1D (2010)	0.75	200	500	±0.5, ±1	1 to 1 M (E24, E96)	1 MΩ<R : -400 to +150	-55 to +155	Grade 0
				±5	1 to 10 M (E24)			
ERJS1T ERJU1T (2512)	1.0	200	500	±0.5, ±1	1 to 1 M (E24, E96)	1 MΩ<R : -400 to +150	-55 to +155	Grade 0
				±5	1 to 10 M (E24)			

- (1) Use it on the condition that the case temperature is below the upper category temperature.
 (2) Rated Continuous Working Voltage (RCWV) shall be determined from $RCWV = \sqrt{\text{Power Rating} \times \text{Resistance Value}}$,
 or Limiting Element Voltage listed above, whichever less.
 (3) Overload Test Voltage (OTV) shall be determined from $OTV = \text{Specified Magnification (refer to performance)} \times RCWV$
 or Maximum Overload Voltage listed above, whichever less.

[Low Resistance type]

Part No. (inch size)	Power Rating at 70 °C ⁽¹⁾ (W)	Resistance Tolerance (%)	Resistance Range (Ω)	T.C.R. (×10 ⁻⁶ /K)	Category Temperature Range (°C)	AEC- Q200 Grade
ERJU6S (0805)	0.25	±1, ±2, ±5	0.1 to 0.2 (E24)	0 to +150	-55 to +155	Grade 0
ERJU6Q (0805)			0.22 to 1 (E24)			

- (1) Use it on the condition that the case temperature is below the upper category temperature.
 · Rated Continuous Working Voltage (RCWV) shall be determined from $RCWV = \sqrt{\text{Power Rating} \times \text{Resistance Value}}$.
 · Overload Test Voltage (OTV) shall be determined from $OTV = \text{Specified Magnification (refer to performance)} \times RCWV$.

[For Jumper]

Part No.	Resistance(Ω)	Rated Current(A)	Maximum Overload Current (A) ⁽¹⁾
ERJU0X ERJU01	100 mΩ or less	0.5	1
ERJS02 ERJU02 ERJS03 ERJU03 ERJS06 ERJU06 ERJS08 ERJU08 ERJS14 ERJU14 ERJS12 ERJU12 ERJS1D ERJU1D ERJS1T ERJU1T		1	2
		2	4

(1) Overload test current

Power Derating Curve

For resistors operated in ambient temperatures above 70 °C, power rating shall be derated in accordance with the figure below.

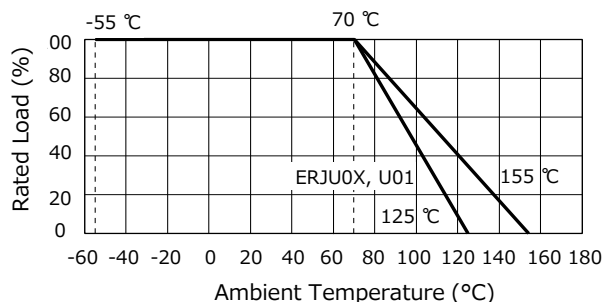

Construction

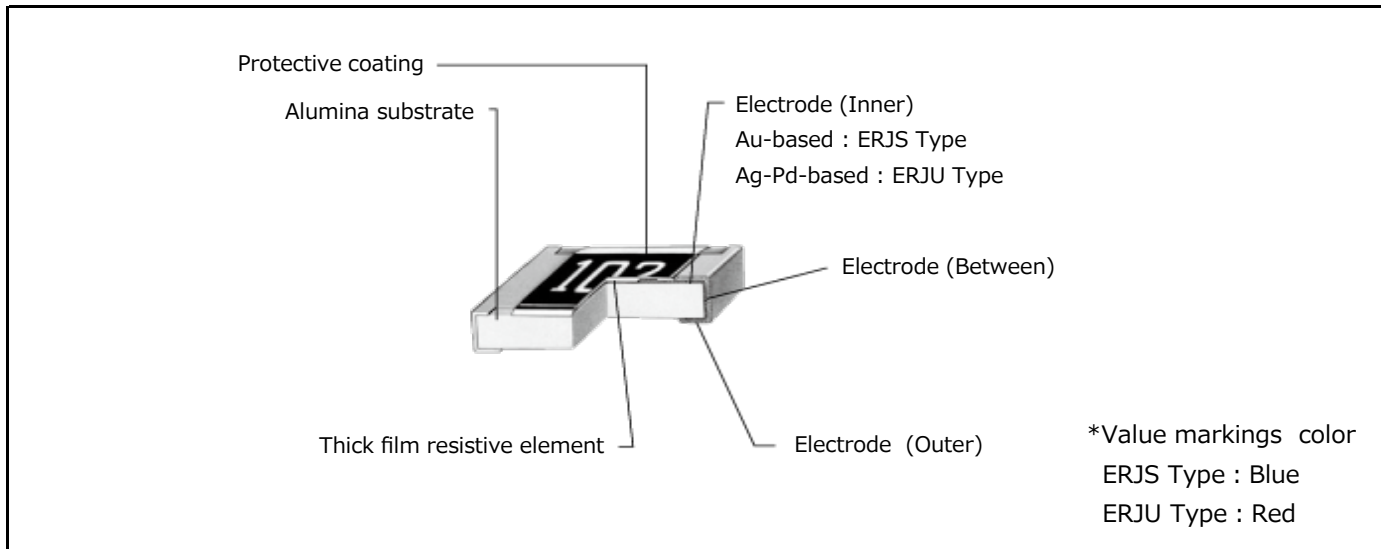

Dimensions in mm (not to scale)

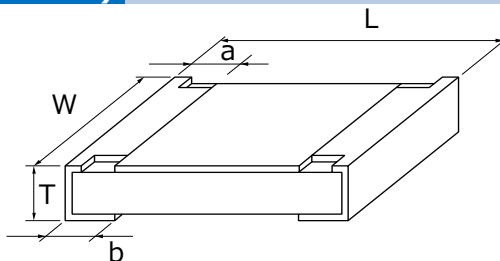

Part No.	Dimensions (mm)					Mass (Weight) (g/1000 pcs)
	L	W	a	b	T	
ERJU0X	0.40±0.02	0.20±0.02	0.10±0.03	0.10±0.03	0.13±0.02	0.04
ERJU01	0.60±0.03	0.30±0.03	0.10±0.05	0.15±0.05	0.23±0.03	0.15
ERJS02 ERJU02	1.00±0.05	0.50±0.05	0.20±0.10	0.25±0.10	0.35±0.05	0.8
ERJS03 ERJU03	1.60±0.15	0.80+0.15/-0.05	0.30±0.20	0.30±0.15	0.45±0.10	2
ERJS06 ERJU06	2.00±0.20	1.25±0.10	0.40±0.20	0.40±0.20	0.60±0.10	4
ERJU6□	2.00±0.20	1.25±0.10	0.45±0.20	0.45±0.20	0.55±0.10	6
ERJS08 ERJU08	3.20+0.05/-0.20	1.60+0.05/-0.15	0.50±0.20	0.50±0.20	0.60±0.10	10
ERJS14 ERJU14	3.20±0.20	2.50±0.20	0.50±0.20	0.50±0.20	0.60±0.10	16
ERJS12 ERJU12	4.50±0.20	3.20±0.20	0.50±0.20	0.50±0.20	0.60±0.10	27
ERJS1D ERJU1D	5.00±0.20	2.50±0.20	0.60±0.20	0.60±0.20	0.60±0.10	27
ERJS1T ERJU1T	6.40±0.20	3.20±0.20	0.65±0.20	0.60±0.20	0.60±0.10	45

Performance

● Series ERJS02 to ERJS1T, ERJU0X to ERJU1T

Test Item	Performance Requirements ΔR		Test Conditions
	Resistor type	Jumper type	
Resistance	Within Specified Tolerance	100 m Ω or less	20 °C
T. C. R.	Within Specified T. C. R.	200 m Ω or less	+25 °C/+155 °C (ERJU0X,U01 : +25 °C/+125 °C)
Overload	± 2 %	100 m Ω or less	Rated Voltage \times 2.5, 5 s Jumper type : Max. Overload Current, 5 s
Resistance to Soldering Heat	± 1 %	100 m Ω or less	270 °C, 10 s
Rapid Change of Temperature	± 1 %	100 m Ω or less	-55 °C (30min.)/+155 °C (ERJU0X,U01 : +125 °C) (30min.), 100 cycles
High Temperature Exposure	± 1 %	100 m Ω or less	+155 °C (ERJU0X,U01 : +125 °C), 1000 h
Damp Heat, Steady State	± 1 %	100 m Ω or less	60 °C, 90 % to 95 %RH, 1000 h
Load Life in Humidity	± 3 %	100 m Ω or less	60 °C, 90 % to 95 %RH, Rated Voltage (Jumper type : Rated Current) , 1.5 h ON / 0.5 h OFF cycle, 1000 h
Endurance at 70 °C	± 3 %	100 m Ω or less	70 °C, Rated Voltage (Jumper type :Rated Current), 1.5 h ON / 0.5 h OFF cycle, 1000 h

● Series ERJU6S, U6Q

Test Item	Performance Requirements ΔR	Test Conditions
Resistance	Within Specified Tolerance	20 °C
T. C. R.	Within Specified T. C. R.	+25 °C/+125 °C
Overload	± 1 %	Rated Voltage \times 2.5, 5 s
Resistance to Soldering Heat	± 1 %	270 °C, 10 s
Rapid Change of Temperature	± 1 %	-55 °C (30 min.) / +125 °C(30min.), 100 cycles
High Temperature Exposure	± 1 %	+155 °C, 1000 h
Damp Heat, Steady State	± 1 %	60 °C, 90 % to 95 %RH, 1000 h
Load Life in Humidity	± 3 %	60 °C, 90 % to 95 %RH, Rated Voltage, 1.5 h ON / 0.5 h OFF cycle, 1000 h
Endurance at 70 °C	± 3 %	70 °C, Rated Voltage, 1.5 h ON / 0.5 h OFF cycle, 1000 h

Anti-Sulfurated Thick Film Chip Resistors /Precision Type



Series: ERJ U2R, U3R, U6R
(Ag-Pd-based inner electrode type)

Features

- High resistance to sulfurization achieved by adopting an Ag-Pd-based inner electrode.
- High precision ... Resistance tolerance : $\pm 0.5\%$ 、TCR : $\pm 50 \times 10^{-6}/K$
- High reliability ... Metal glaze thick film resistive element and three layers of electrodes.
- Suitable for both reflow and flow soldering.
- Reference Standard ... IEC 60115-8, JIS C 5201-8, JEITA RC-2134C
- AEC-Q200 compliant
- RoHS compliant

■ As for Packaging Methods, Land Pattern, Soldering Conditions and Safety Precautions, Please see Data Files

Explanation of Part Numbers

● ERJU2R, U3R, U6R Series

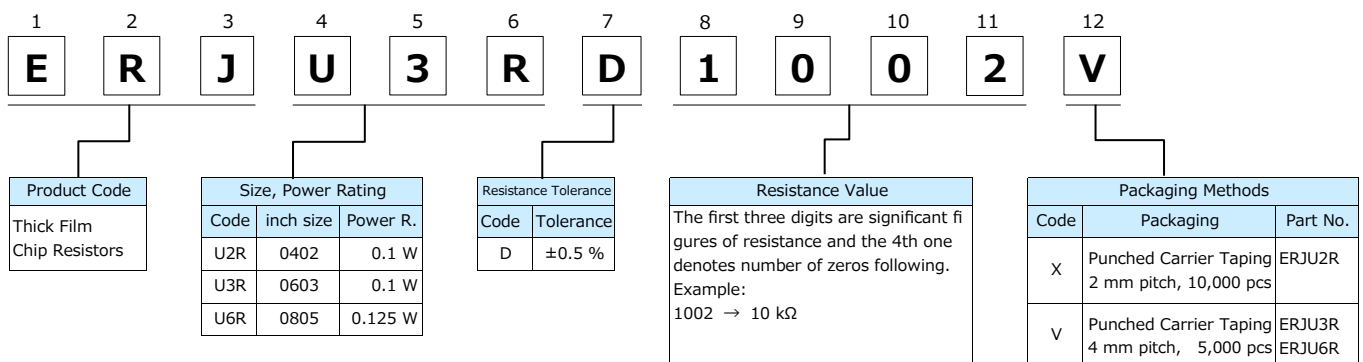

Ratings

Part No. (inch size)	Power Rating at 70 °C ⁽¹⁾ (W)	Limiting Element Voltage ⁽²⁾ (V)	Maximum Overload Voltage ⁽³⁾ (V)	Resistance Tolerance (%)	Resistance Range (Ω)	T.C.R. ($\times 10^{-6}/K$)	Category Temperature Range (°C)	AEC- Q200 Grade
ERJU2R (0402)	0.1	50	100	± 0.5	100 to 100 k (E24, E96)	± 50	-55 to +155	Grade 0
ERJU3R (0603)	0.1	50	100	± 0.5	100 to 100 k (E24, E96)		-55 to +155	Grade 0
ERJU6R (0805)	0.125	150	200	± 0.5	100 to 100 k (E24, E96)		-55 to +155	Grade 0

- (1) Use it on the condition that the case temperature is below the upper category temperature.
- (2) Rated Continuous Working Voltage (RCWV) shall be determined from $RCWV = \sqrt{\text{Power Rating} \times \text{Resistance Value}}$, or Limiting Element Voltage listed above, whichever less.
- (3) Overload Test Voltage (OTV) shall be determined from $OTV = \text{Specified Magnification (refer to performance)} \times RCWV$ or Maximum Overload Voltage listed above, whichever less.

Power Derating Curve

For resistors operated in ambient temperatures above 70 °C, power rating shall be derated in accordance with the figure on the right.

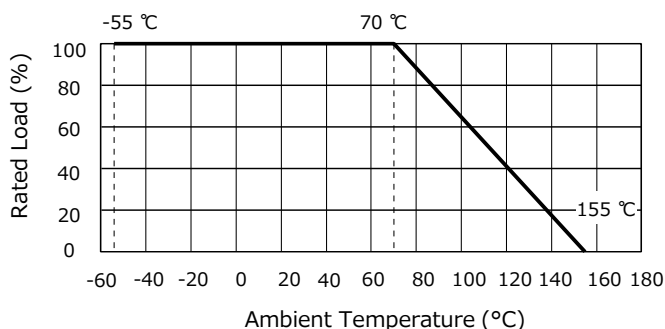

Construction

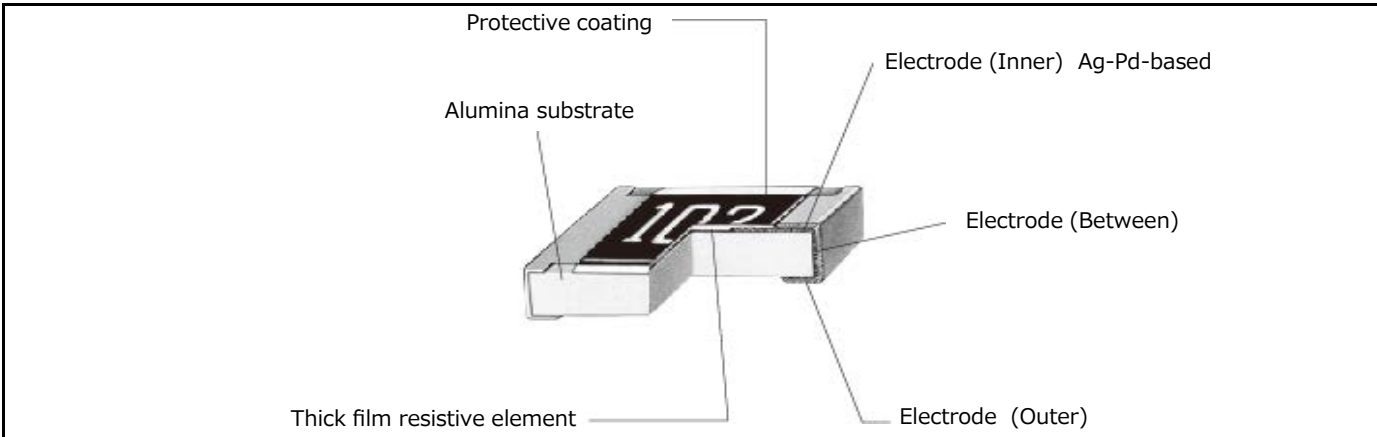

Dimensions in mm (not to scale)

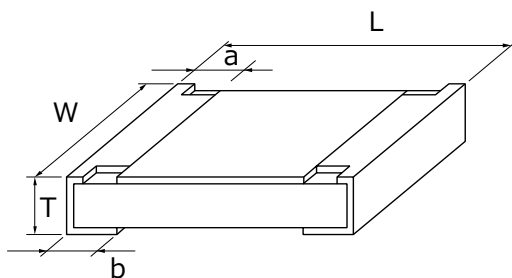

Part No.	Dimensions (mm)					Mass (Weight) (g/1000 pcs)
	L	W	a	b	T	
ERJU2R	1.00±0.05	0.50±0.05	0.20±0.10	0.25±0.10	0.35±0.05	0.8
ERJU3R	1.60±0.15	0.80+0.15/-0.05	0.30±0.20	0.30±0.15	0.45±0.10	2
ERJU6R	2.00±0.20	1.25±0.10	0.40±0.20	0.40±0.20	0.60±0.10	4

Performance

Test Item	Performance Requirements ΔR	Test Conditions
Resistance	Within Specified Tolerance	20 °C
T. C. R.	Within Specified T. C. R.	+25 °C/+155 °C
Overload	±2 %	Rated Voltage × 2.5, 5 s
Resistance to Soldering Heat	±1 %	270 °C, 10 s
Rapid Change of Temperature	±1 %	-55 °C (30 min.) / +155 °C(30 min.), 100 cycles
High Temperature Exposure	±1 %	+155 °C, 1000 h
Damp Heat, Steady State	±1 %	60 °C, 90 % to 95 %RH, 1000 h
Load Life in Humidity	±2 %	60 °C, 90 % to 95 %RH, Rated Voltage, 1.5 h ON / 0.5 h OFF cycle , 1000 h
Endurance at 70 °C	±2 %	70 °C, , Rated Voltage, 1.5 h ON / 0.5 h OFF cycle, 1000 h

Anti-Sulfurated Thick Film Chip Resistors / Anti-Surge Type

101 102 103

Series: ERJ UP3, UP6, UP8

Features

- High resistance to sulfurization achieved by adopting Anti-Sulfurated electrode material (Ag-Pd-based inner electrode) and structure
- ESD surge characteristics superior to standard metal film resistors
- High reliability... Metal glaze thick film resistive element and three layers of electrodes
- Suitable for both reflow and flow soldering
- High power 0.25 W : 0603 inch / 1608 mm size (ERJUP3)
0.50 W : 0805 inch / 2012 mm size (ERJUP6)
0.66 W : 1206 inch / 3216 mm size (ERJUP8)
- Reference Standard ... IEC 60115-8, JIS C 5201-8, JEITA RC-2134C
- AEC-Q200 compliant
- RoHS compliant

■ As for Packaging Methods, Land Pattern, Soldering Conditions and Safety Precautions, Please see Data Files

Explanation of Part Numbers

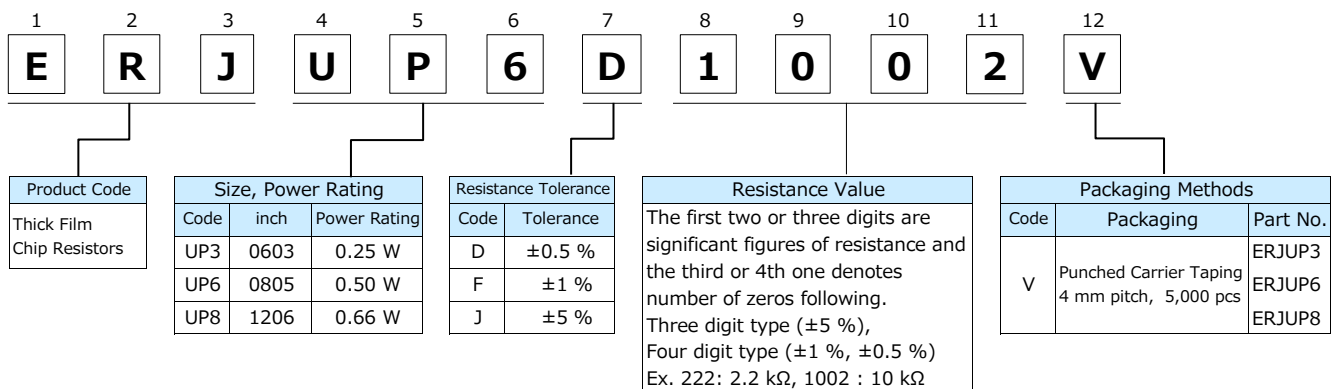

Ratings

Part No. (inch size)	Power Rating ⁽¹⁾ at 70 °C (W)	Limiting Element Voltage ⁽²⁾ (V)	Maximum Overload Voltage ⁽³⁾ (V)	Resistance Tolerance (%)	Resistance Range (Ω)	T.C.R. (×10 ⁻⁶ /K)	Category Temperature Range (°C)	AEC-Q200 Grade
ERJUP3 (0603)	0.25	150	200	±0.5, ±1	10 to 1 M (E24, E96)	±100	-55 to +155	Grade 0
				±5	1 to 1.5 M (E24)	±200		
ERJUP6 (0805)	0.50	400	600	±0.5, ±1	10 to 1 M (E24, E96)	±100	-55 to +155	Grade 0
				±5	1 to 3.3 M (E24)	R<10 Ω : -100 to +600 10 Ω≤R : ±200		
ERJUP8 (1206)	0.66	500	1000	±0.5, ±1	10 to 1 M (E24, E96)	±100	-55 to +155	Grade 0
				±5	1 to 10 M (E24)	R<10 Ω : -100 to +600 10 Ω≤R : ±200		

- (1) Use it on the condition that the case temperature is below the upper category temperature.
(2) Rated Continuous Working Voltage (RCWV) shall be determined from $RCWV = \sqrt{\text{Power Rating} \times \text{Resistance Value}}$, or Limiting Element Voltage listed above, whichever less.
(3) Overload Test Voltage (OTV) shall be determined from $OTV = \text{Specified Magnification (refer to performance)} \times RCWV$ or Maximum Overload Voltage listed above, whichever less.

Power Derating Curve

For resistors operated in ambient temperatures above 70 °C, power rating shall be derated in accordance with the figure on the right.

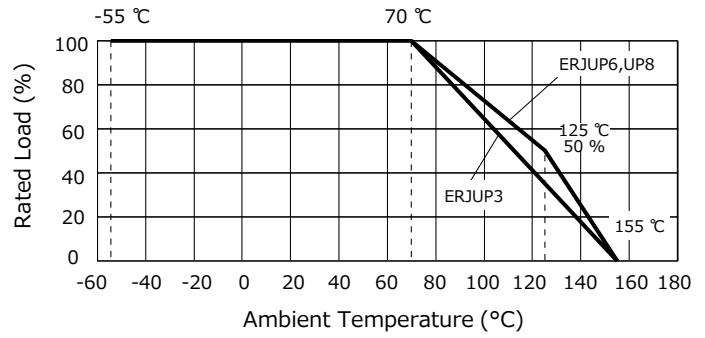

Construction

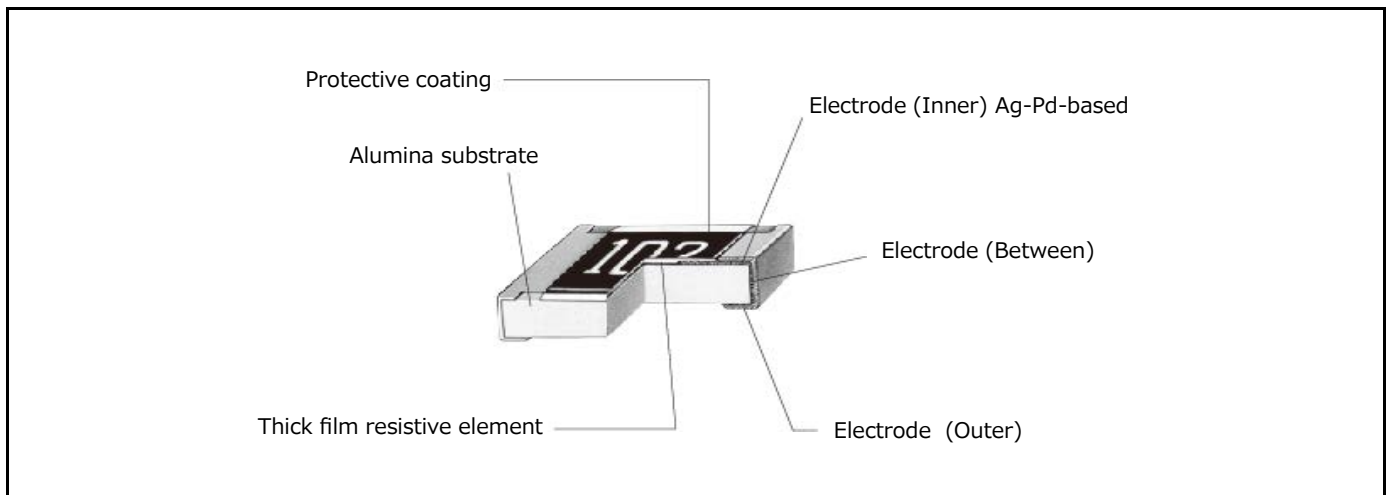

Dimensions in mm (not to scale)

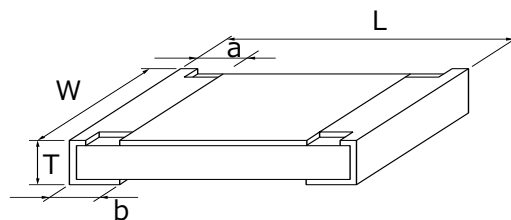

Part No.	Dimensions (mm)					Mass (Weight) (g/1000 pcs)
	L	W	a	b	T	
ERJUP3	1.60±0.15	0.80+0.15/-0.05	0.15+0.15/-0.10	0.25±0.10	0.45±0.10	2
ERJUP6	2.00±0.20	1.25±0.10	0.25±0.20	0.40±0.20	0.60±0.10	4
ERJUP8	3.20+0.05/-0.20	1.6+0.05/-0.15	0.40±0.20	0.50±0.20	0.60±0.10	10

ESD Characteristic

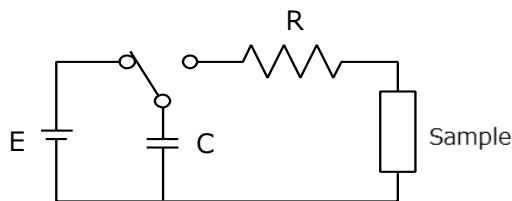

R	R=0 Ω(≤1.5 kΩ) / 150 Ω(> 1.5 kΩ)
C	150 pF
E	±3 kV

— Anti-Sulfurated Thick Film Chip Resistors / Anti-Surge Type (ERJUP Type)
 - - - Anti-Sulfurated Thick Film Chip Resistors (ERJU Type)

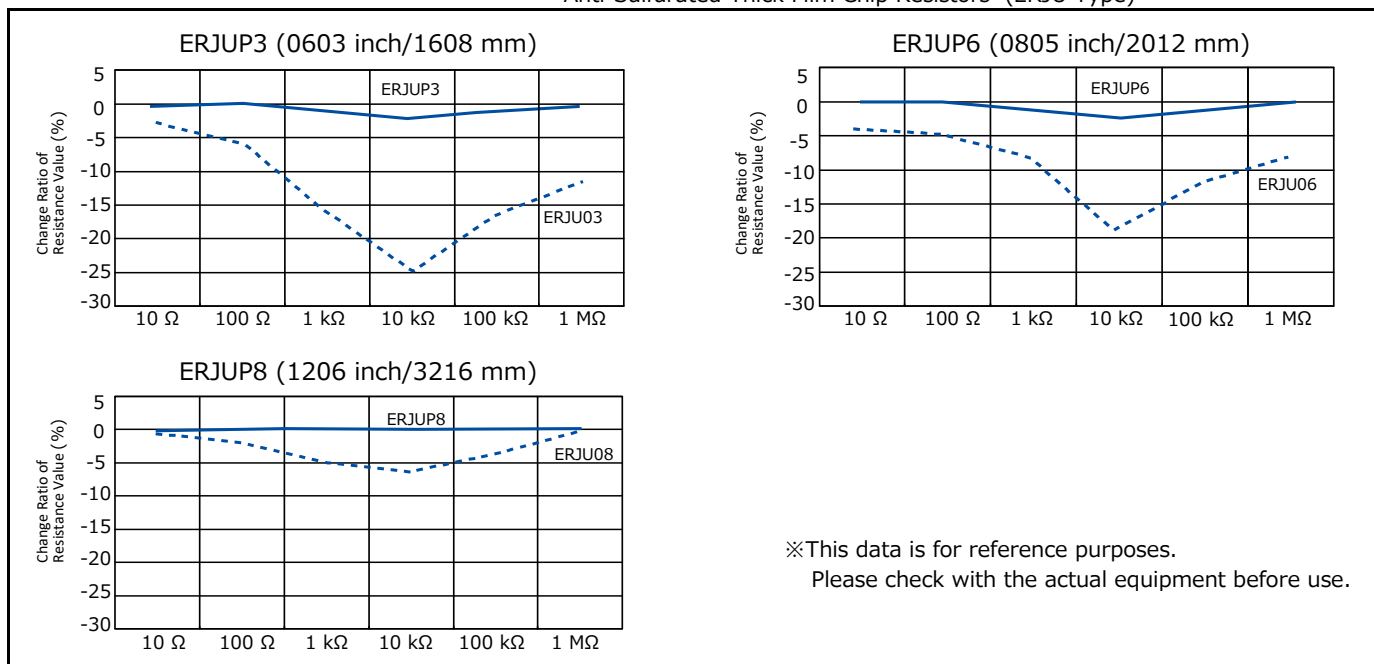

Performance

Test Item	Performance Requirements ΔR	Test Conditions
Resistance	Within Specified Tolerance	20 °C
T. C. R.	Within Specified T. C. R.	+25 °C/+155 °C
Overload	±2 %	ERJUP6 : Rated Voltag× 1.77, 5 s ERJUP3, ERJUP8 : Rated Voltag× 2.0 , 5 s
Resistance to Soldering Heat	D : ±0.5 %, F, J : ±1 %	270 °C, 10 s
Rapid Change of Temperature	±1 %	-55 °C (30 min.) / +155 °C (30 min.), 100 cycles
High Temperature Exposure	±1 %	+155 °C, 1000 h
Damp Heat, Steady State	±1 %	60 °C, 90 % ~ 95 %RH, 1000 h
Load Life in Humidity	±3 %	60 °C, 90 % ~ 95 %RH, Rated Voltage, 1.5 h ON / 0.5 h OFF cycle , 1000 h
Endurance at 70 °C	±3 %	70 °C, Rated Voltage, 1.5 h ON / 0.5 h OFF cycle, 1000 h

Anti-Sulfurated High Power Chip Resistors / Wide Terminal Type



Series: ERJ C1

Features

- High resistance to sulfurization achieved by adopting Anti-Sulfurated electrode material (Ag-Pd-based inner electrode) and structure (Covered electrode)
- High solder-joint reliability by wide terminal construction
- Excellent heat dissipation characteristics by wide terminal construction
- AEC-Q200 compliant
- RoHS compliant

Recommended Applications

- Motor control circuit of the industrial equipment
- Automotive electronic circuits including ECUs (Electrical control unit), anti-lock breaking systems and air-bag systems
- Current sensing for power supply circuits in a variety of equipment

■ **As for Packaging Methods, Land Pattern, Soldering Conditions and Safety Precautions,** Please see Data Files

Explanation of Part Numbers

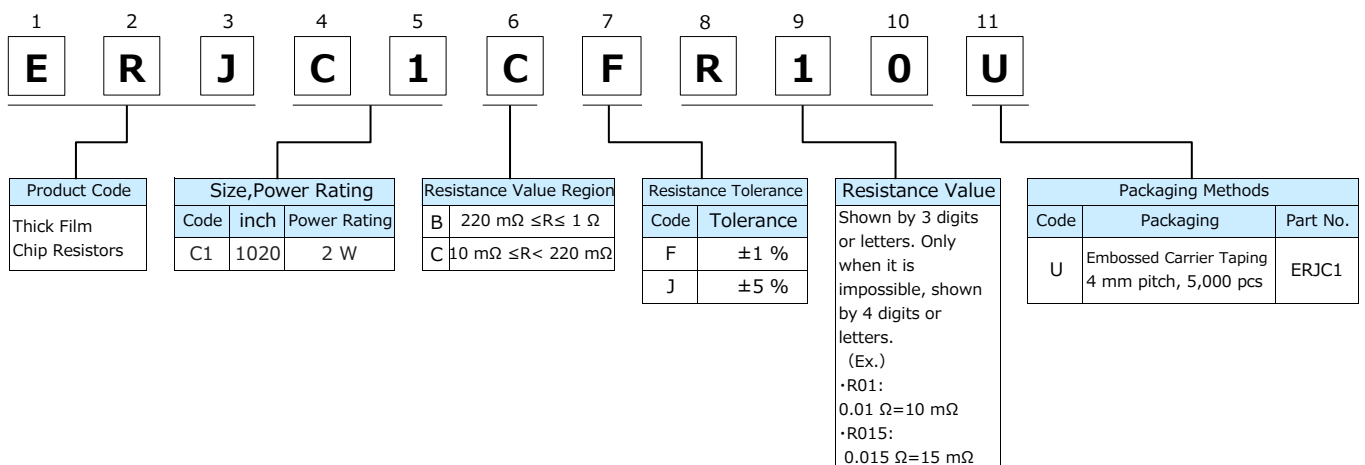

Ratings

Part No. (inch size)	Power Rating at 70 °C ⁽¹⁾ (W)	Resistance Tolerance (%)	Resistance Range (Ω)	T.C.R. (×10 ⁻⁶ /K)	Category Temperature Range (°C)	AEC-Q200 Grade
ERJC1 (1020)	2	±1	10 m to 1 (E24)	10 mΩ ≤ R < 22 mΩ : 0 to +350 22 mΩ ≤ R < 47 mΩ : 0 to +200 47 mΩ ≤ R < 100 mΩ : 0 to +150 100 mΩ ≤ R ≤ 1 Ω : ±100	-55 to +155	Grade 0
		±5		10 mΩ ≤ R < 22 mΩ : 0 to +350 22 mΩ ≤ R < 100 mΩ : 0 to +200 100 mΩ ≤ R ≤ 1 Ω : ±200		

(1) Use it on the condition that the case temperature is below the upper category temperature.

- Rated Continuous Working Voltage (RCWV) shall be determined from $RCWV = \sqrt{\text{Power Rating} \times \text{Resistance Value}}$.
- Overload Test Voltage (OTV) shall be determined from $OTV = \text{Specified Magnification (refer to performance)} \times RCWV$.

Power Derating Curve

For resistors operated in ambient temperatures above 70 °C, power rating shall be derated in accordance with the figure on the right.

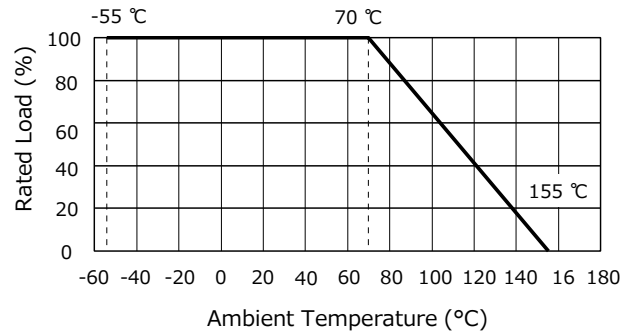

Construction

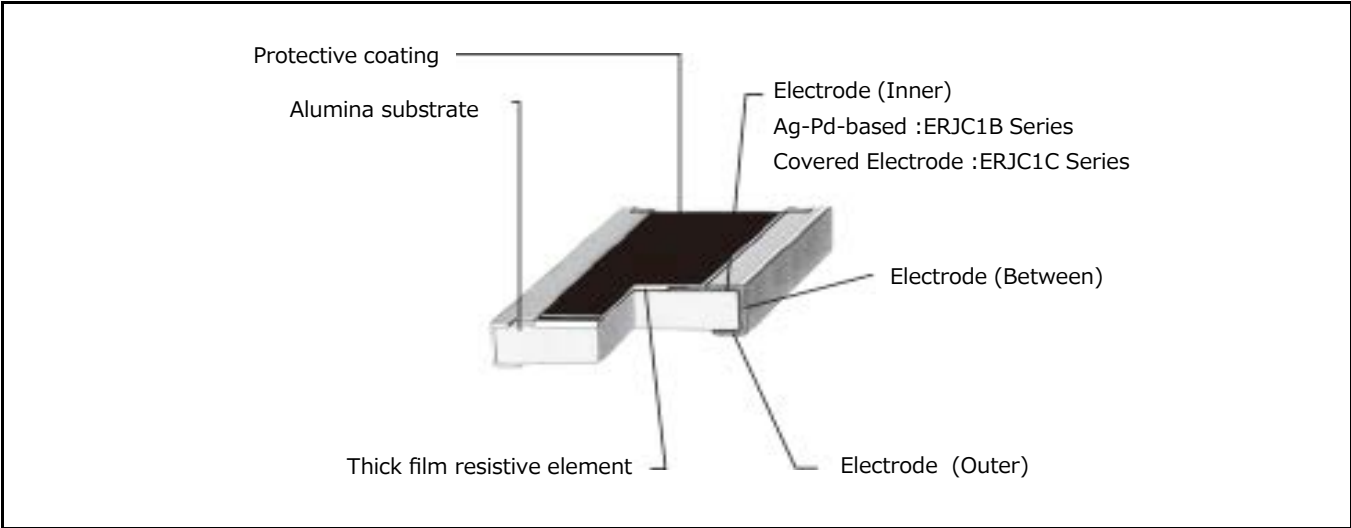

Dimensions in mm (not to scale)

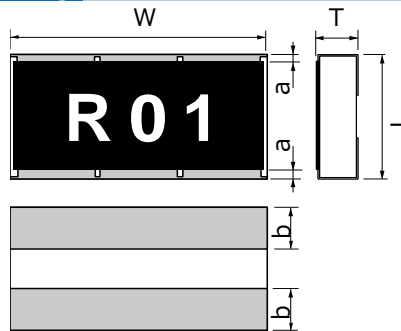

Part No.	Dimensions (mm)					Mass (Weight) (g/1000 pcs)
	L	W	T	a	b	
ERJC1B	2.50±0.20	5.00±0.20	0.55±0.20	0.35±0.20	0.90±0.20	27
ERJC1C				0.60±0.20		

Circuit Configuration

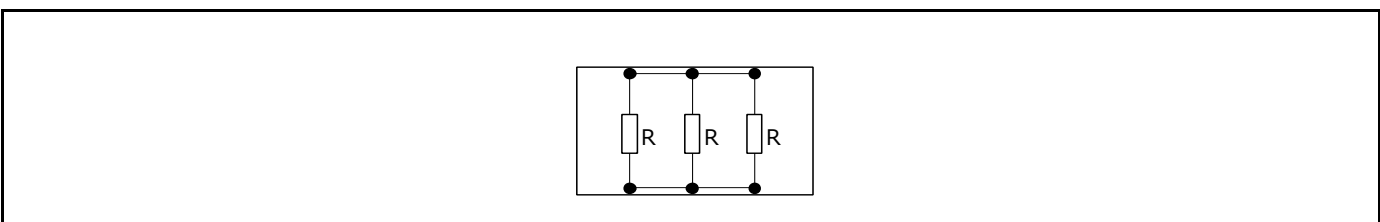

Performance

Test Item	Performance Requirements Δ	Test Conditions
Resistance	Within Specified Tolerance	20 °C
T. C. R.	Within Specified T. C. R.	+25 °C/+125 °C
Overload	± 2 %	Rated Voltage \times 2.0, 5 s
Resistance to Soldering Heat	± 1 %	270 °C, 10 s
Rapid Change of Temperature	± 2 %	-55 °C (30 min.) / +125 °C (30 min.), 1000 cycles
High Temperature Exposure	± 1 %	+155 °C, 1000 h
Damp Heat, Steady State	± 1 %	60 °C, 90 % to 95 %RH, 1000 h
Load Life in Humidity	± 3 %	60 °C, 90 % to 95 %RH, Rated Voltage, 1.5 h ON / 0.5 h OFF cycle , 1000 h
Endurance at 70 °C	± 3 %	70 °C, Rated Voltage, 1.5 h ON / 0.5 h OFF cycle, 1000 h

Chip Resistors Array

**Series: EXB 14V, 18V, 24V, 28V,
N8V, 2HV, 34V, V4V,
38V, V8V, S8V**

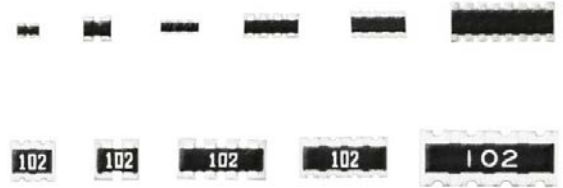

Features

- High density
2 resistors in 0.8 mm × 0.6 mm size / 0302 inch size : EXB14V
4 resistors in 1.4 mm × 0.6 mm size / 0502 inch size : EXB18V
2 resistors in 1.0 mm × 1.0 mm size / 0404 inch size : EXB24V
4 resistors in 2.0 mm × 1.0 mm size / 0804 inch size : EXB28V, N8V
8 resistors in 3.8 mm × 1.6 mm size / 1506 inch size : EXB2HV
2 resistors in 1.6 mm × 1.6 mm size / 0606 inch size : EXB34V, V4V
4 resistors in 3.2 mm × 1.6 mm size / 1206 inch size : EXB38V, V8V
4 resistors in 5.1 mm × 2.2 mm size / 2009 inch size : EXBS8V
- Improvement of placement efficiency
Placement efficiency of Chip Resistor Array is two, four or eight times of the flat type chip resistor
- Reference Standard … IEC 60115-9, JIS C 5201-9, EIAJ RC-2129
- AEC-Q200 compliant (EXB2, EXB3)
- RoHS compliant

■ **As for Packaging Methods, Land Pattern, Soldering Conditions and Safety Precautions,**
Please see Data Files

Explanation of Part Numbers

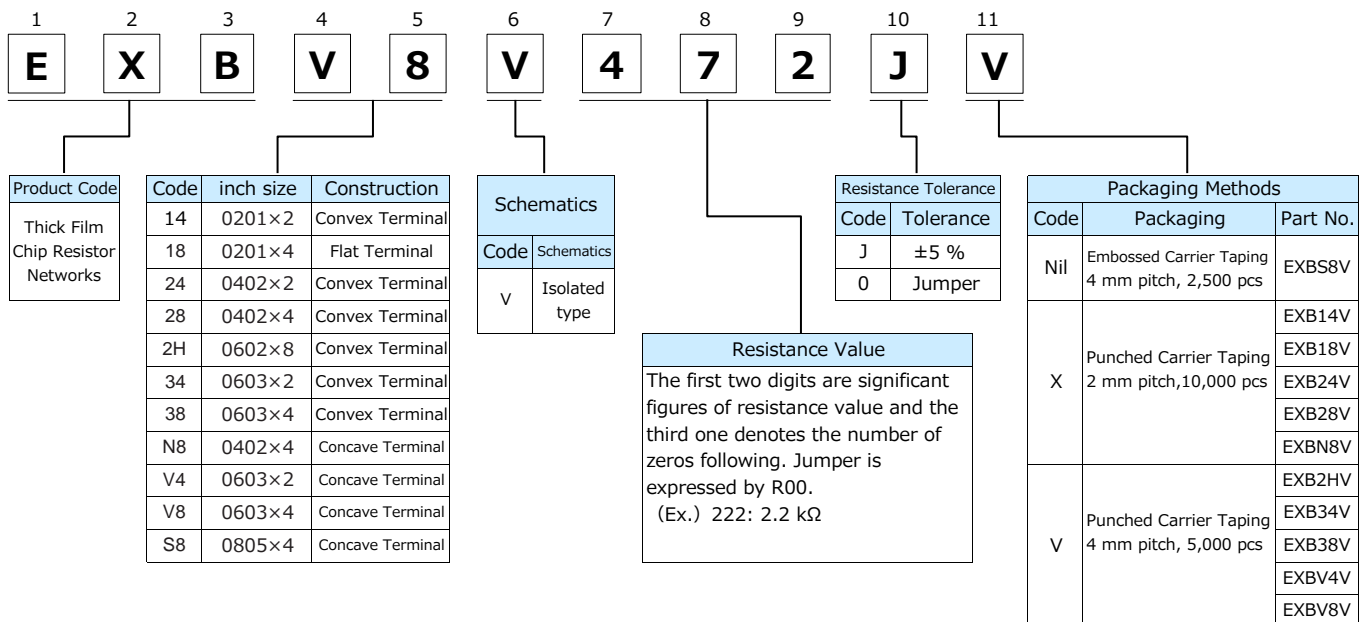

Ratings

(For Resistor)

Part No. (inch size)	Power Rating at 70 °C (W/element)	Limiting Element Voltage ⁽¹⁾ (V)	Maximum Overload Voltage ⁽²⁾ (V)	Resistance Tolerance (%)	Resistance Range (Ω)	T.C.R. (×10 ⁻⁶ /K)	Category Temperature Range (°C)	AEC- Q200 Grade
EXB14V (0201×2)	0.031	12.5	25	±5	10 to 1 M (E24)	R<10 Ω : -200 to +600 10 Ω to 1 MΩ: ±200	-55 to +125	-
EXB18V (0201×4)	0.031 (0.1 W / package)	12.5	25	±5	10 to 1 M (E24)		-55 to +125	-
EXB24V (0402×2)	0.063	50	100	±5	1 to 1 M (E24)		-55 to +125	Grade 1
EXB28V (0402×4)	0.063	50	100	±5	1 to 1 M (E24)		-55 to +125	Grade 1
EXB2HV (0602×8)	0.063 (0.25 W / package)	25	50	±5	10 to 1 M (E24)		-55 to +125	Grade 1
EXB34V (0603×2)	0.063	50	100	±5	1 to 1 M (E24)		-55 to +125	Grade 1
EXB38V (0603×4)	0.063	50	100	±5	1 to 1 M (E24)		-55 to +125	Grade 1
EXBN8V (0402×4)	0.031	50	100	±5	10 to 1 M (E24)		-55 to +125	-
EXBV4V (0603×2)	0.063	50	100	±5	10 to 1 M (E24)		-55 to +125	-
EXBV8V (0603×4)	0.063	50	100	±5	10 to 1 M (E24)		-55 to +125	-
EXBS8V (0805×4)	0.1	100	200	±5	10 to 1 M (E24)		-55 to +125	-

(1) Rated Continuous Working Voltage (RCWV) shall be determined from $RCWV = \sqrt{\text{Power Rating} \times \text{Resistance Value}}$, or Limiting Element Voltage listed above, whichever less.

(2) Overload Test Voltage (OTV) shall be determined from $OTV = \text{Specified Magnification (refer to performance)} \times RCWV$ or Maximum Overload Voltage listed above, whichever less.

(For Jumper)

Part No.	Resistance(Ω)	Rated Current (A / element)	Maximum Overload Current (A) ⁽¹⁾
EXB14V	50 mΩ or less	0.5	1
EXB18V		0.5	1
EXB24V		1	2
EXB28V		1	2
EXB2HV		1	2
EXB34V		1	2
EXB38V		1	2
EXBN8V		1	2
EXBV4V		1	2
EXBV8V		1	2
EXBS8V		2	4

(1) Overload test current

Power Derating Curve

For resistors operated in ambient temperatures above 70 °C, power rating shall be derated in accordance with the figure below.

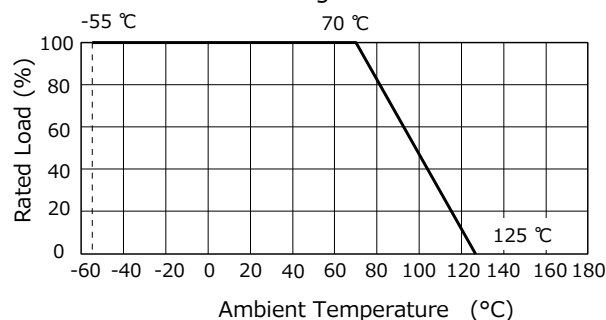

Construction(Example : Concave Terminal)

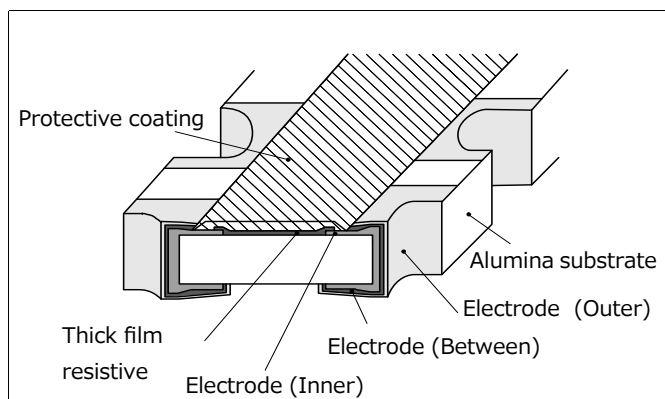

Schematics

● Isolated type

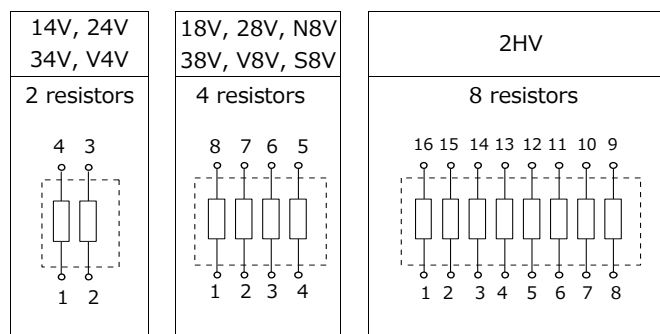

Dimensions in mm (not to scale)

(1) Convex Terminal type

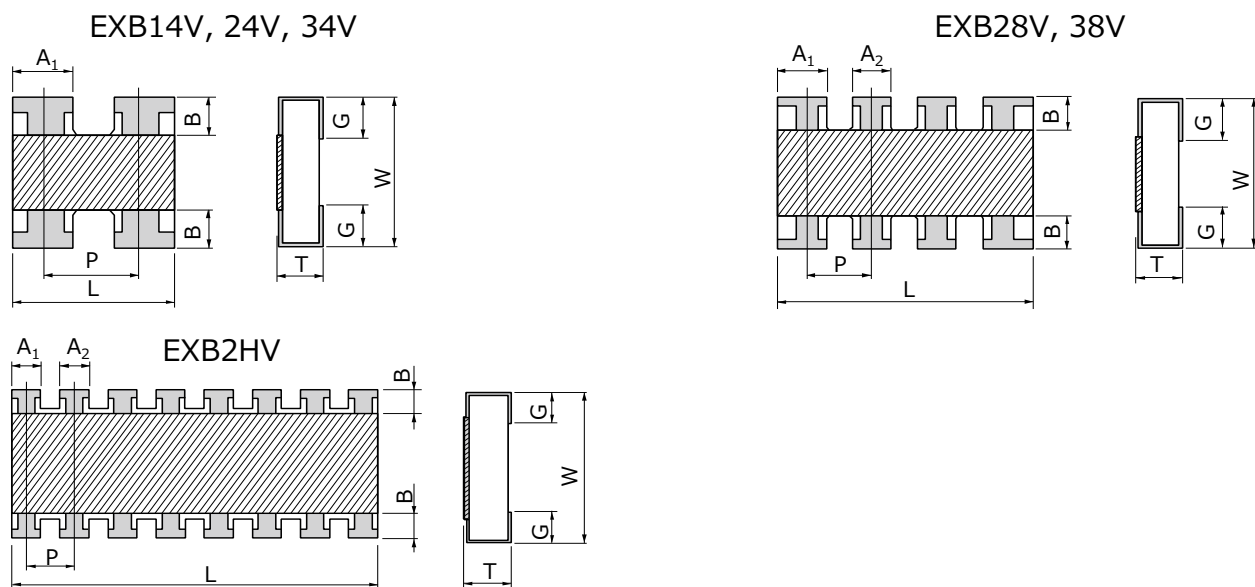

Part No. (inch size)	Dimensions (mm)								Mass (Weight)
	L	W	T	A ₁	A ₂	B	P	G	(g/1000 pcs)
EXB14V (0603X2)	0.80±0.10	0.60±0.10	0.35±0.10	0.35±0.10	—	0.15±0.10	(0.50)	0.15±0.10	0.5
EXB24V (1005×2)	1.00±0.10	1.00±0.10	0.35±0.10	0.40±0.10	—	0.18±0.10	(0.65)	0.25±0.10	1.2
EXB28V (1005×4)	2.00±0.10	1.00±0.10	0.35±0.10	0.45±0.10	0.35±0.10	0.20±0.10	(0.50)	0.25±0.10	2.0
EXB2HV (1605×8)	3.80±0.10	1.60±0.10	0.45±0.10	0.35±0.10	0.35±0.10	0.30±0.10	(0.50)	0.30±0.10	9.0
EXB34V (1608×2)	1.60±0.20	1.60±0.15	0.50±0.10	0.65±0.15	—	0.30±0.20	(0.80)	0.30±0.20	3.5
EXB38V (1608×4)	3.20±0.20	1.60±0.15	0.50±0.10	0.65±0.15	0.45±0.15	0.30±0.20	(0.80)	0.35±0.20	7.0

() Reference

(2) Concave Terminal type

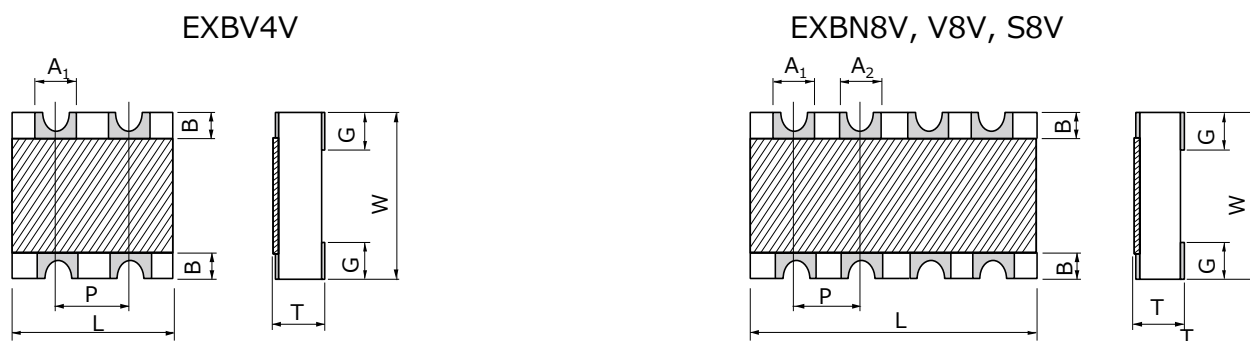

Part No. (inch size)	Dimensions (mm)								Mass (Weight)
	L	W	T	A ₁	A ₂	B	P	G	(g/1000 pcs)
EXBN8V (1005×4)	2.00±0.10	1.00±0.10	0.45±0.10	0.30±0.10	0.30±0.10	0.20±0.15	(0.50)	0.30±0.15	3.0
EXBV4V (1608×2)	1.60 +0.20/-0.10	1.60 +0.20/-0.10	0.60±0.10	0.60±0.10	—	0.30±0.15	(0.80)	0.45±0.15	5.0
EXBV8V (1608×4)	3.20 +0.20/-0.10	1.60 +0.20/-0.10	0.60±0.10	0.60±0.10	0.60±0.10	0.30±0.15	(0.80)	0.45±0.15	10
EXBS8V (2012×4)	5.08 +0.20/-0.10	2.20 +0.20/-0.10	0.70±0.20	0.80±0.15	0.80±0.15	0.50±0.15	(1.27)	0.55±0.15	30

() Reference

Dimensions in mm (not to scale)

(3) Flat Terminal type EXB18V

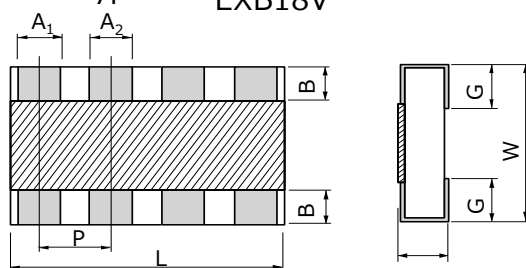

Part No. (inch size)	Dimensions (mm)								Mass (Weight) (g/1000 pcs)
	L	W	T	A ₁	A ₂	B	P	G	
EXB18V (0603×4)	1.40±0.10	0.60±0.10	0.35±0.10	0.20±0.10	0.20±0.10	0.10±0.10	(0.40)	0.20±0.10	1.0

() Reference

Performance

Test Item	Performance Requirements ΔR	Test Conditions
Resistance	Within Specified Tolerance	20 °C
T. C. R.	Within Specified T. C. R.	+25 °C/+125 °C
Overload	±2 %	Rated Voltage× 2.5, 5 s Jumper type : Max. Overload Current, 5 s
Resistance to Soldering Heat	±1 %	270 °C, 10 s
Rapid Change of Temperature	±1 %	-55 °C (30 min.) / +155 °C (30 min.), 100 cycles
High Temperature Exposure	±1 %	+125 °C, 1000 h
Damp Heat, Steady State	±1 %	60 °C, 90 % to 95 %RH, 1000 h
Load Life in Humidity	±3 %	60 °C, 90 % to 95 %RH, Rated Voltage (Jumper type : Rated Current), 1.5 h ON / 0.5 h OFF cycle, 1000 h
Endurance at 70 °C	±3 %	70 °C, Rated Voltage (Jumper type : Rated Current), 1.5 h ON / 0.5 h OFF cycle, 1000 h

Anti-Sulfurated Chip Resistors Array



**Series: EXB U14, U18, U24,
U28, U2H, U34, U38**

Features

- High resistance to sulfurization achieved by adopting an Ag-Pd-based inner electrode
- High density
 - 2 resistors in 0.8 mm × 0.6 mm size / 0302 inch size : EXBU14
 - 4 resistors in 1.4 mm × 0.6 mm size / 0502 inch size : EXBU18
 - 2 resistors in 1.0 mm × 1.0 mm size / 0404 inch size : EXBU24
 - 4 resistors in 2.0 mm × 1.0 mm size / 0804 inch size : EXBU28
 - 8 resistors in 3.8 mm × 1.6 mm size / 1506 inch size : EXBU2H
 - 2 resistors in 1.6 mm × 1.6 mm size / 0606 inch size : EXBU34
 - 4 resistors in 3.2 mm × 1.6 mm size / 1206 inch size : EXBU38
- Improvement of placement efficiency
Placement efficiency of Chip Resistor Array is two, four or eight times of the flat type chip resistor
- Reference Standard ... IEC 60115-9, JIS C 5201-9, EIAJ RC-2129
- AEC-Q200 compliant (EXBU2, EXBU3)
- RoHS compliant

■ **As for Packaging Methods, Land Pattern, Soldering Conditions and Safety Precautions,**
Please see Data Files

Explanation of Part Numbers

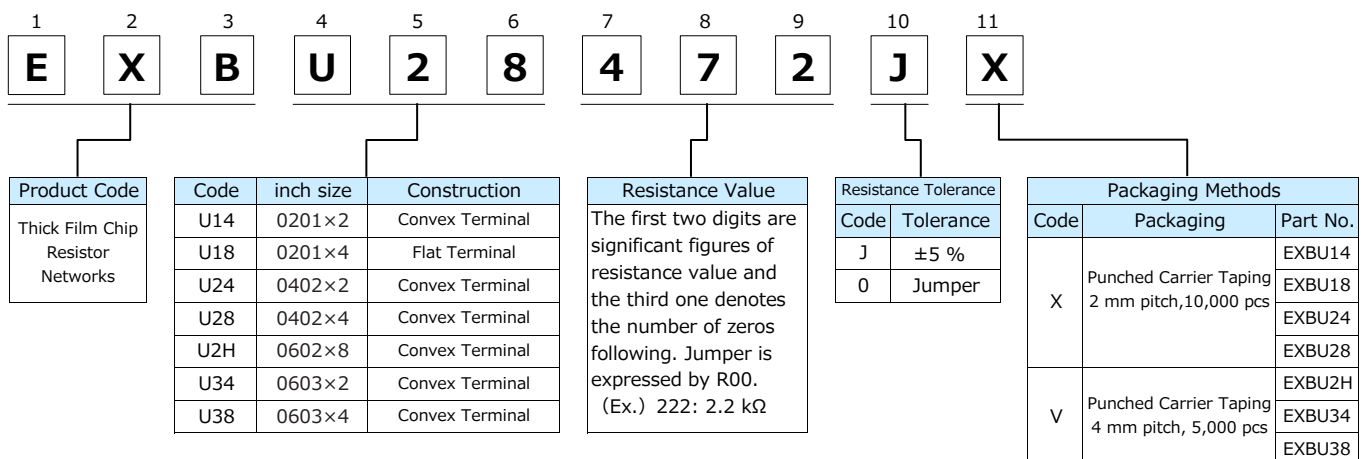

Ratings

[For Resistor]

Part No. (inch size)	Power Rating at 70 °C (W/element)	Limiting Element Voltage ⁽¹⁾ (V)	Maximum Overload Voltage ⁽²⁾ (V)	Resistance Tolerance (%)	Resistance Range (Ω)	T.C.R. ($\times 10^{-6}/K$)	Category Temperature Range (°C)	AEC- Q200 Grade
EXBU14 (0201×2)	0.031	12.5	25	±5	10 to 1 M (E24)	R<10 Ω : -200 to +600	-55 to +125	-
EXBU18 (0201×4)	0.031 (0.1 W / package)	12.5	25	±5	10 to 1 M (E24)		-55 to +125	-
EXBU24 (0402×2)	0.063	50	100	±5	1 to 1 M (E24)		-55 to +125	Grade 1
EXBU28 (0402×4)	0.063	50	100	±5	1 to 1 M (E24)		-55 to +125	Grade 1
EXBU2H (0602×8)	0.063 (0.25 W / package)	25	50	±5	10 to 1 M (E24)	10 Ω to 1 MΩ : ±200	-55 to +125	Grade 1
EXBU34 (0603×2)	0.063	50	100	±5	1 to 1 M (E24)		-55 to +125	Grade 1
EXBU38 (0603×4)	0.063	50	100	±5	1 to 1 M (E24)		-55 to +125	Grade 1

(1) Rated Continuous Working Voltage (RCWV) shall be determined from $RCWV = \sqrt{\text{Power Rating} \times \text{Resistance Value}}$, or Limiting Element Voltage listed above, whichever less.

(2) Overload Test Voltage (OTV) shall be determined from $OTV = \text{Specified Magnification (refer to performance)} \times RCWV$ or Maximum Overload Voltage listed above, whichever less.

[For Jumper]

Part No.	Resistance(Ω)	Rated Current (A / element)	Maximum Overload Current (A) ⁽¹⁾
EXBU24	100 mΩ or less	1	2
EXBU28			
EXBU2H			
EXBU34			
EXBU38			

(1) Overload test current

Power Derating Curve

For resistors operated in ambient temperatures above 70 °C, power rating shall be derated in accordance with the figure below.

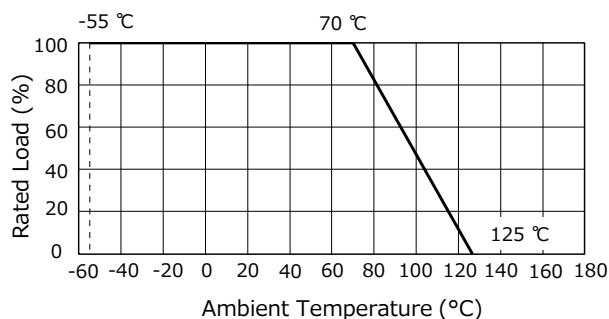

Construction

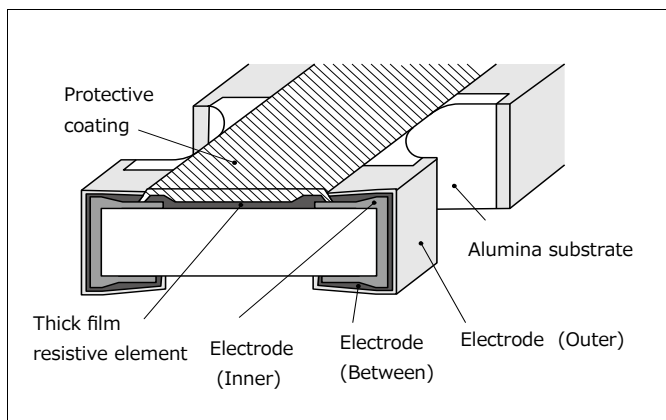

Schematics

● Isolated type

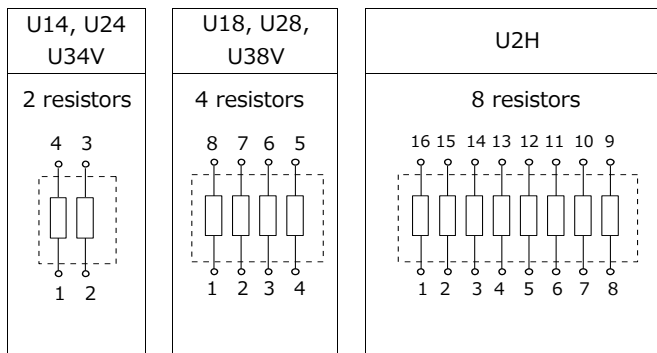

Dimensions in mm (not to scale)

EXBU14, U24, U34

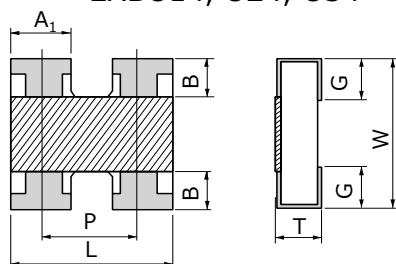

EXBU18

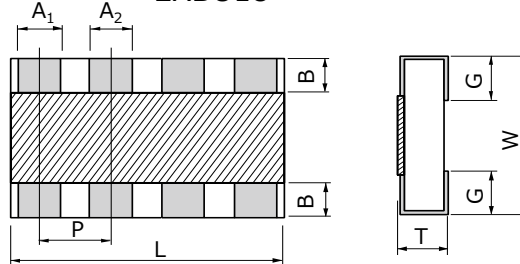

EXBU28, U38

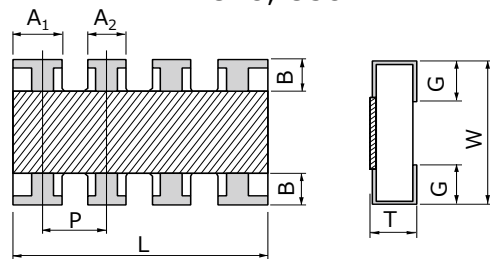

EXBU2H

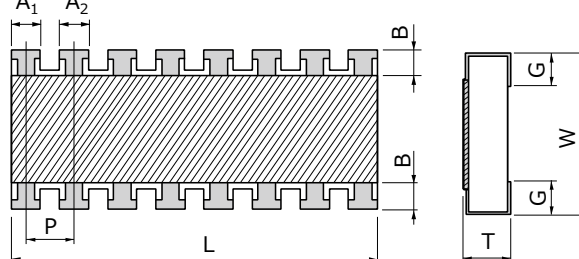

Part No. (inch size)	Dimensions (mm)								Mass (Weight) (g/1000 pcs)
	L	W	T	A ₁	A ₂	B	P	G	
EXBU14 (0201x2)	0.80±0.10	0.60±0.10	0.35±0.10	0.35±0.10	—	0.15±0.10	(0.50)	0.15±0.10	0.5
EXBU18 (0201x4)	1.40±0.10	0.60±0.10	0.35±0.10	0.20±0.10	0.20±0.10	0.10±0.10	(0.40)	0.20±0.10	1.0
EXBU24 (0402x2)	1.00±0.10	1.00±0.10	0.35±0.10	0.40±0.10	—	0.18±0.10	(0.65)	0.25±0.10	1.2
EXBU28 (0402x4)	2.00±0.10	1.00±0.10	0.35±0.10	0.45±0.10	0.35±0.10	0.20±0.10	(0.50)	0.25±0.10	2.0
EXBU2H (0602x8)	3.80±0.10	1.60±0.10	0.45±0.10	0.35±0.10	0.35±0.10	0.30±0.10	(0.50)	0.30±0.10	9.0
EXBU34 (0603x2)	1.60±0.20	1.60±0.15	0.50±0.10	0.65±0.15	—	0.30±0.20	(0.80)	0.30±0.20	3.5
EXBU38 (0603x4)	3.20±0.20	1.60±0.15	0.50±0.10	0.65±0.15	0.45±0.15	0.30±0.20	(0.80)	0.35±0.20	7.0

Performance

Test Item	Performance Requirements ΔR	Test Conditions
Resistance	Within Specified Tolerance	20 °C
T. C. R.	Within Specified T. C. R.	+25 °C/+125 °C
Overload	±2 %	Rated Voltage× 2.5, 5 s Jumper type : Max. Overload Current, 5 s
Resistance to Soldering Heat	±1 %	270 °C, 10 s
Rapid Change of Temperature	±1 %	-55 °C (30 min.) / +125 °C (30 min.), 100 cycles
High Temperature Exposure	±1 %	+125 °C, 1000 h
Damp Heat, Steady State	±1 %	60 °C, 90 % to 95 %RH, 1000 h
Load Life in Humidity	±3 %	60 °C, 90 % to 95 %RH, Rated Voltage (Jumper type : Rated Current), 1.5 h ON / 0.5 h OFF cycle, 1000 h
Endurance at 70 °C	±3 %	70 °C, Rated Voltage (Jumper type : Rated Current), 1.5 h ON / 0.5 h OFF cycle, 1000 h

Chip Resistors Networks



Series: EXB D, E, A, Q

Features

- High density placing for digital signal circuits
 - Bussed 8 or 15 resistors for pull up/down circuits
 - EXBD : 3.2 mm × 1.6 mm × 0.55 mm, 0.635 mm pitch
 - EXBE : 4.0 mm × 2.1 mm × 0.55 mm, 0.8 mm pitch
 - EXBA : 6.4 mm × 3.1 mm × 0.55 mm, 1.27 mm pitch
 - EXBQ : 3.8 mm × 1.6 mm × 0.45 mm, 0.5 mm pitch
 - Available direct placing on the bus line by means of half pitch spacing without through-holes on PWB (“High density placing” is shown below)
- High speed mounting using conventional placing machine
- Reference Standard … IEC 60115-9, JIS C 5201-9, EIAJ RC-2130
- RoHS compliant

[High density placing]

Pull up resistors

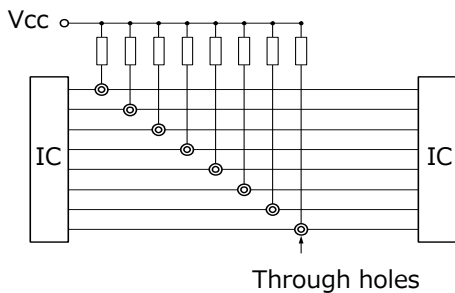

No through hole

Direct placement on the bus line

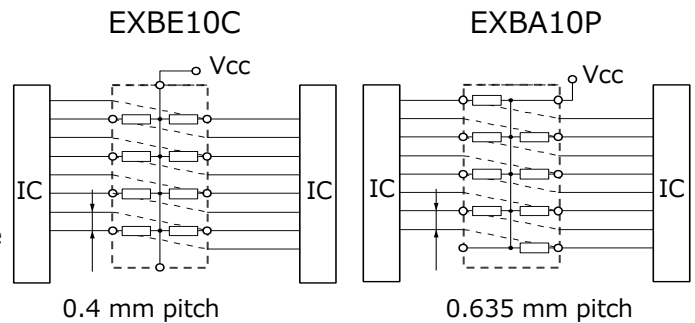

■ **As for Packaging Methods, Land Pattern, Soldering Conditions and Safety Precautions,**
Please see Data Files

Explanation of Part Numbers

1	2	3	4	5	6	7	8	9	10	11	12
E	X	B	E	1	0	C	1	0	3	J	
Suffix for Special Requirements											
Product Code Thick Film Resistor Networks	Dimension Code of Chip Resistor Network			Number of Terminals 10 Terminals (EXBD, EXBE, EXBA) 16 Terminals (EXBQ)	Circuit Configuration			Resistance Value The first two digits are significant figures of resistance value and the third one denotes the number of zeros following.	Resistance Tolerance		
	Code	Inch	Dimensions		Code	Common Terminal Position			Code	Tolerance	
	D	1206	3.2 × 1.6 mm		C	Center common circuit (EXBD, EXBE)			J	±5 %	
	E	1608	4.0 × 2.1 mm		P	Diagonal common circuit (Terminal 5 and Terminal 10) (EXBA)					
	A	2512	6.4 × 3.1 mm		P	One side common circuit (Terminal 16) (EXBQ)					
	Q	1506	3.8 × 1.6 mm		E	Diagonal common circuit (Terminal 1 and Terminal 6) (EXBA)					

Ratings

Part No. (inch size)	Resistance Range (Ω)	Resistance Tolerance (%)	Number of Terminals	Number of Resistors	Power Rating ⁽¹⁾ at 70 °C (W/element)	Limiting Element Voltage ⁽²⁾ (V)	Maximum Overload Voltage ⁽³⁾ (V)	T.C.R. (×10 ⁻⁶ /K)	Category Temperature Range (°C)	AEC-Q200 Grade
EXBD (1206)	47 to 1 M (E12)	±5	10 terminals	8 element	0.05 / element	25	50	±200	-55 to +125	-
EXBE (1608)					0.063 / element	25	50	±200	-55 to +125	-
EXBA (2512)					0.063 / element	50	100	±200	-55 to +125	-
EXBQ (1506)	100 to 470 k (E6)		16 terminals	15 element	0.025 / element	25	50	±200	-55 to +125	-

- (1) Use it on the condition that the case temperature is below the upper category temperature.
- (1) Rated Continuous Working Voltage (RCWV) shall be determined from $RCWV = \sqrt{\text{Power Rating} \times \text{Resistance Value}}$, or Limiting Element Voltage listed above, whichever less.
- (2) Overload Test Voltage (OTV) shall be determined from $OTV = \text{Specified Magnification (refer to performance)} \times RCWV$ or Maximum Overload Voltage listed above, whichever less.

Power Derating Curve

For resistors operated in ambient temperatures above 70 °C, power rating shall be derated in accordance with the figure on the right.

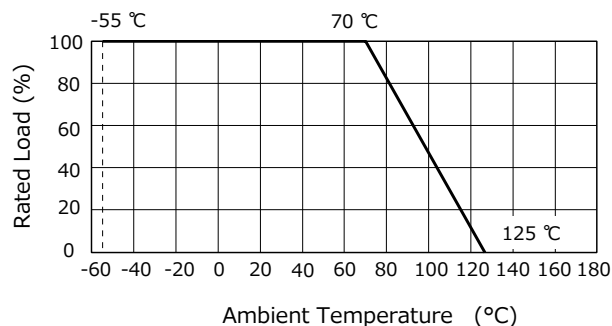

Construction(Example : EXBD)

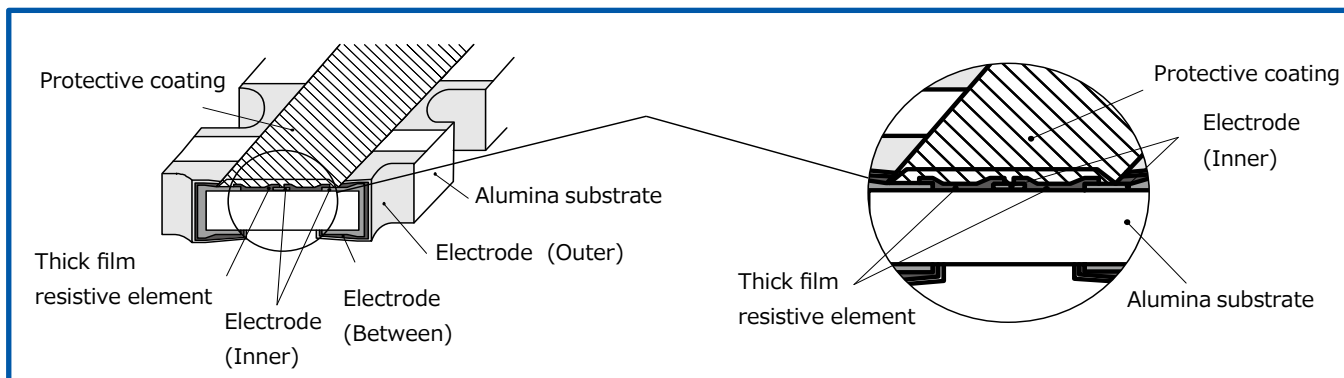

Circuit Configuration

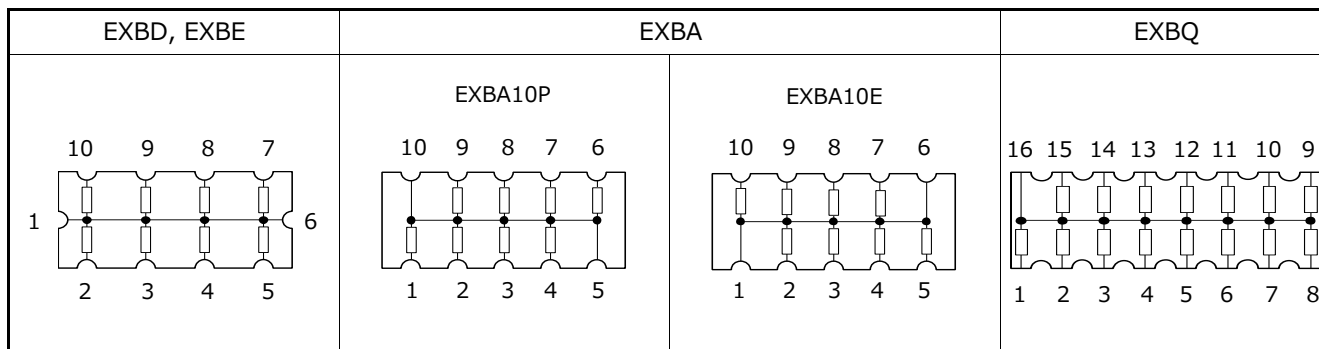

Dimensions in mm (not to scale)

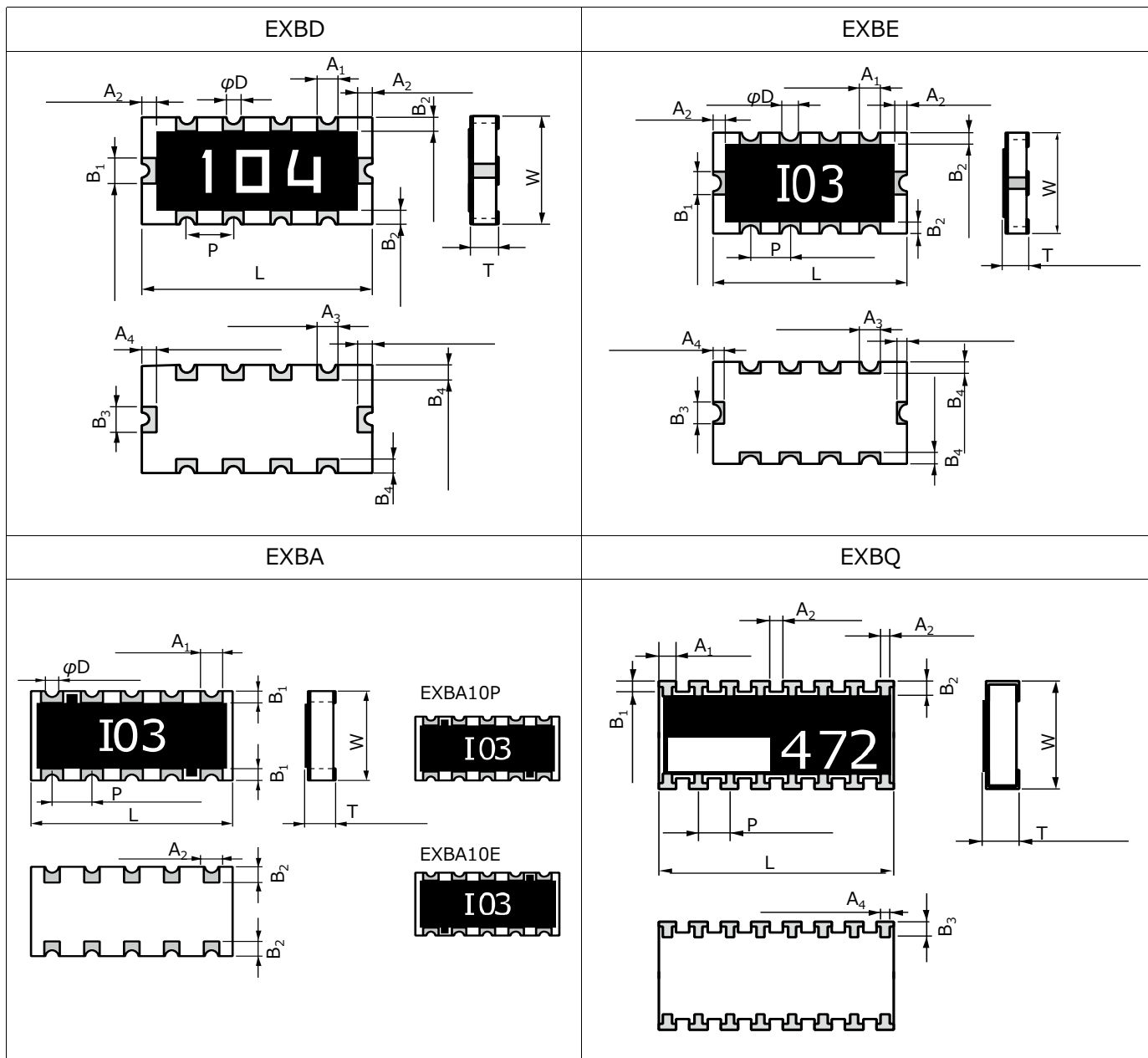

Part No.	Dimensions (mm)							Mass (Weight) (g/1000 pcs)
	L	W	T	A ₁	A ₂	B ₁	B ₂	
EXBD	3.20±0.15	1.60±0.15	0.55±0.10	0.33±0.15	0.2±0.1	0.40±0.15	0.2±0.1	10
	A ₃	A ₄	B ₃	B ₄	P	φ D		
	0.3±0.1	0.25±0.10	0.40±0.15	0.35±0.15	0.635±0.10	0.2±0.1		
Part No.	Dimensions (mm)							Mass (Weight) (g/1000 pcs)
	L	W	T	A ₁	A ₂	B ₁	B ₂	
EXBE	4.0±0.2	2.1±0.2	0.55±0.10	0.5±0.2	0.3±0.2	0.5±0.2	0.25±0.20	16
	A ₃	A ₄	B ₃	B ₄	P	φ D		
	0.4±0.2	0.35±0.20	0.5±0.2	0.4±0.2	0.8±0.1	0.3+0.1/-0.2		
Part No.	Dimensions (mm)							Mass (Weight) (g/1000 pcs)
	L	W	T	A ₁	B ₁	A ₂	B ₂	
EXBA	6.4±0.2	3.1±0.2	0.55±0.10	0.7±0.2	0.3±0.2	0.5±0.2	0.5±0.20	40
	P	φ D						
	1.27±0.10	0.3+0.1/-0.2						
Part No.	Dimensions (mm)							Mass (Weight) (g/1000 pcs)
	L	W	T	A ₁	A ₂	A ₃	B ₁	
EXBQ	3.8±0.2	1.6±0.2	0.45±0.10	0.3±0.1	0.2±0.1	0.15+0.15/-0.05	0.15+0.15/-0.05	9
	B ₂	A ₄	B ₃	P				
	0.25±0.15	0.15+0.20/-0.05	0.30±0.15	0.5±0.1				

Performance

Test Item	Performance Requirements ΔR	Test Conditions
Resistance	Within Specified Tolerance	20 °C
T. C. R.	Within Specified T. C. R.	+25 °C/+125 °C
Overload	±3 %	Rated Voltage× 2.5, 5 s
Resistance to Soldering Heat	±1 %	260 °C ±5 °C, 5 s ±1 s
Rapid Change of Temperature	±2 %	-55 °C (30 min.) / +125 °C (30 min.), 5 cycles
High Temperature Exposure	±3 %	+125 °C, 100 h
Load Life in Humidity	±3 %	60 °C±2 °C, 90 % to 95 %RH, Rated Power × 0.1, 1.5 h ON / 0.5 h OFF cycle, 500 h
Endurance at 70 °C	±5 %	70 °C±2 °C, Rated Voltage, 1.5 h ON / 0.5 h OFF cycle, 1000 h

Chip Attenuator



Series: EXB 14AT, 24AT

Features

- Unbalanced n type attenuator circuit in one chip
EXB14AT(0.8 mm×0.6 mm) , EXB24AT(1.0 mm×1.0 mm)
- Reduced mounting area :
EXB14AT : About 60 % smaller than the area of an attenuator circuit consisting of three 0603 chip resistors, almost equal to the area of three 0402 chip resistors
EXB24AT : About 50 % smaller than the area of an attenuator circuit consisting of three 1005 chip resistors, almost equal to the area of three 0603 chip resistors
- Mounting cost reduction : (Only 1 chip placed as compared to 3)
- Attenuation : 1 dB to 10 dB
- RoHS compliant

Recommended Applications

- Attenuation / level control / impedance matching of high frequency
(communication signalling equipment cellular phones(GSM, CDMA, PDC, etc.), PHS, PDAs)
- **As for Packaging Methods, Land Pattern, Soldering Conditions and Safety Precautions,**
Please see Data Files

Explanation of Part Numbers

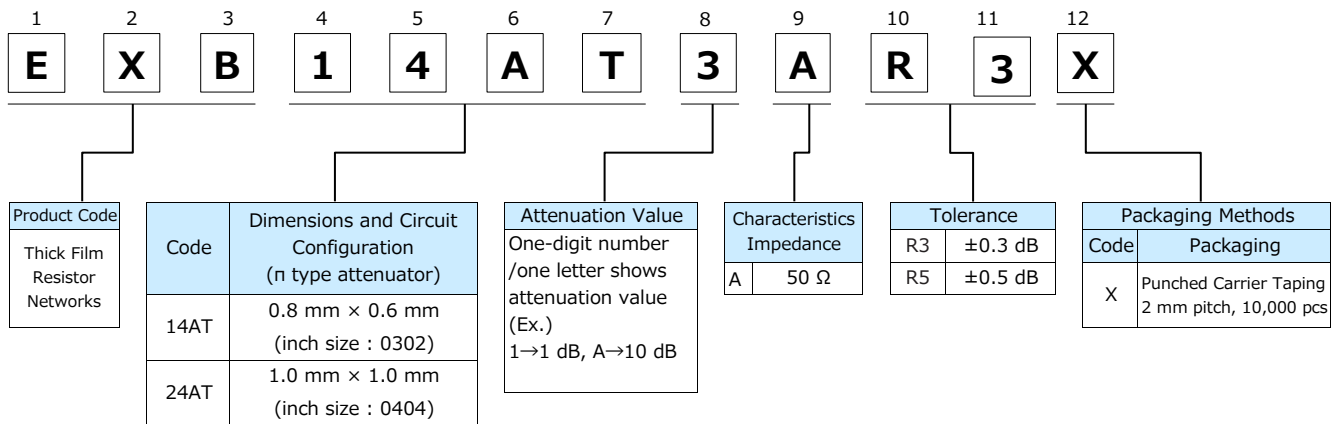

Ratings

Part No.	EXB14AT, EXB24AT
Attenuation Value	1 dB, 2 dB, 3 dB, 4 dB, 5 dB, 6 dB, 10 dB*
Attenuation Value Tolerance	1 dB, 2 dB, 3 dB, 4 dB, 5dB : ±0.3 dB 6 dB, 10 dB : ±0.5 dB
Characteristic Impedance	50 Ω
Power Rating at 70 °C	0.04 W/ package
Frequency Range	DC to 3.0 GHz
VSWR (Voltage Standing Wave Ratio)	1.3 max.
Number of Resistors	3 resistors
Number of Terminals	4 terminals
Category Temperature Range	-55 °C to +125 °C

* Please inquire about the other Attenuator value

Power Derating Curve

For resistors operated in ambient temperatures above 70 °C, power rating shall be derated in accordance with the figure on the right.

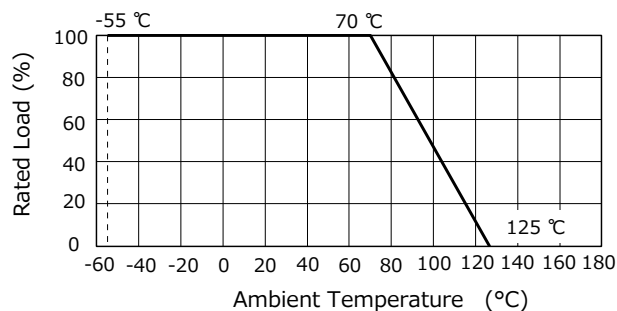

Construction

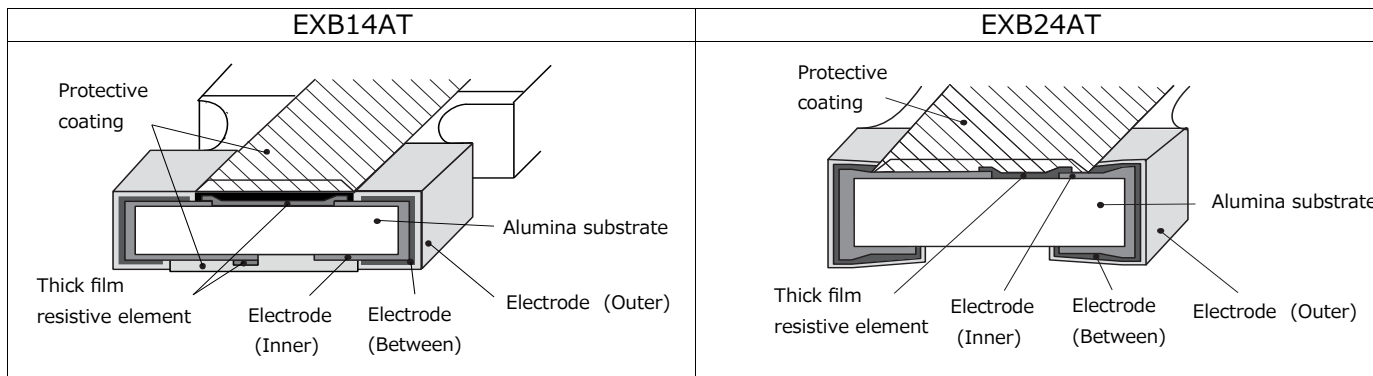

Circuit Configuration

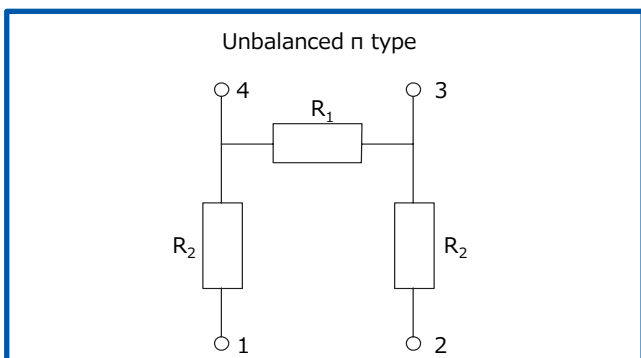

Attenuation-Frequency Characteristics

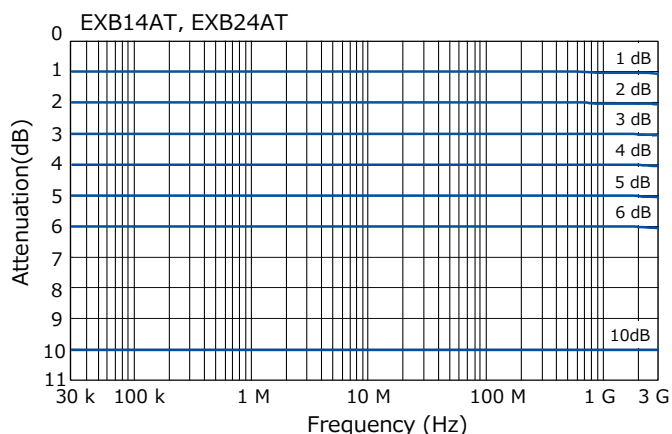

Dimensions in mm (not to scale)

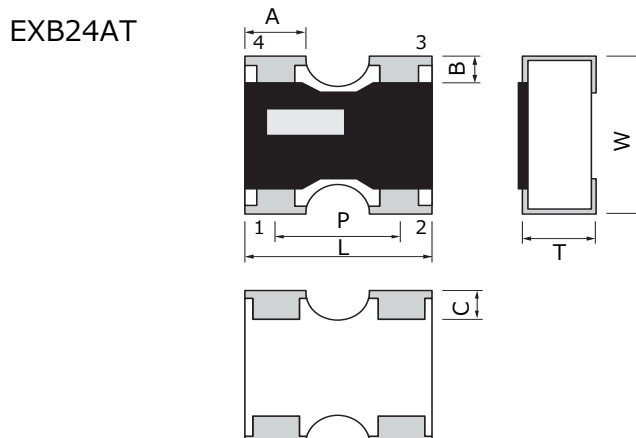
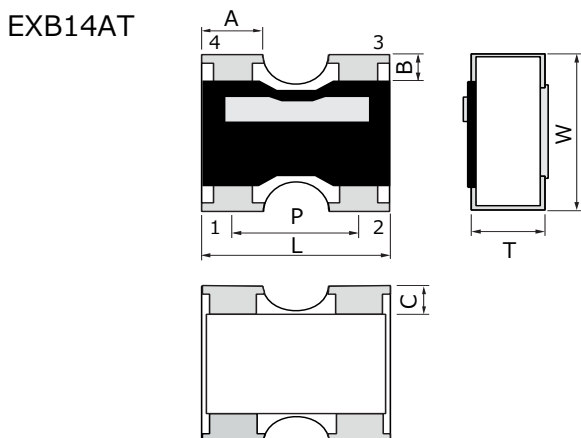

< Marking Configuration >
The bar marking for recognizing terminal direction is located on the side of terminal 3, 4.

< Marking Configuration >
The bar marking for recognizing terminal direction is located on the side of terminal 4.

Part No.	Dimensions (mm)							Mass (Weight) (g/1000 pcs)
	L	W	T	A	B	C	P(typical value)	
EXB14AT	0.80±0.10	0.60±0.10	0.35±0.10	0.35±0.10	0.15±0.10	0.15±0.10	0.50	0.7
EXB24AT	1.00±0.10	1.00±0.10	0.35±0.10	0.40±0.10	0.15±0.10	0.25±0.10	0.65	1.1

Surface Mount Resistors Series			Packaging (Standard Quantity : pcs/reel)			
Products	Part No.	Size mm (inch)	Pressed Carrier Taping (2 mm pitch)	Punched Carrier Taping (2 mm pitch)	Punched Carrier Taping (4 mm pitch)	Embossed Carrier Taping (4 mm pitch)
Thick Film Chip Resistors	ERJXGN	0402(01005)	20,000 *	—	—	40,000 **
	ERJ1GN	0603(0201)	15,000	—	—	—
	ERJ2GE	1005(0402)	—	10,000	—	—
	ERJ3GE	1608(0603)	—	—	5,000	—
	ERJ6GE	2012(0805)	—	—	5,000	—
	ERJ8GE	3216(1206)	—	—	5,000	—
	ERJ14	3225(1210)	—	—	—	5,000
	ERJ12	4532(1812)	—	—	—	5,000
	ERJ12Z	5025(2010)	—	—	—	5,000
	ERJ1T	6432(2512)	—	—	—	4,000
Precision Thick Film Chip Resistors	ERJXGN	0402(01005)	20,000 *	—	—	40,000 **
	ERJ1GN/1RH	0603(0201)	15,000	—	—	—
	ERJ2RC/2RH/2RK	1005(0402)	—	10,000	—	—
	ERJ3RB/3RE/3EK	1608(0603)	—	—	5,000	—
	ERJ6RB/6RE/6EN	2012(0805)	—	—	5,000	—
	ERJ8EN	3216(1206)	—	—	5,000	—
	ERJ14N	3225(1210)	—	—	—	5,000
	ERJ12N	4532(1812)	—	—	—	5,000
	ERJ12S	5025(2010)	—	—	—	5,000
ERJ1TN	6432(2512)	—	—	—	4,000	
Metal Film (Thin Film) Chip Resistors, High Reliability Type	ERA1A	0603(0201)	15,000	—	—	—
	ERA2A/2V	1005(0402)	—	10,000	—	—
	ERA3A/3V/3K	1608(0603)	—	—	5,000	—
	ERA6A/6V/6K	2012(0805)	—	—	5,000	—
	ERA8A	3216(1206)	—	—	5,000	—
Thick Film Chip Resistors/Low Resistance Type	ERJ2LW/2BW	1005(0402)	10,000	—	—	—
	ERJ2BS/2BQ	1005(0402)	—	10,000	—	—
	ERJ3L/3B/3R/L03	1608(0603)	—	—	5,000	—
	ERJ6L/6B/6C	2012(0805)	—	—	5,000	—
	ERJ6D/6R/L06	2012(0805)	—	—	5,000	—
	ERJ8B/8C/8R/L08	3216(1206)	—	—	5,000	—
	ERJ14B/14R/L14	3225(1210)	—	—	—	5,000
	ERJ12R/L12	4532(1812)	—	—	—	5,000
	ERJ12Z/L1D	5025(2010)	—	—	—	5,000
	ERJ1TR	6432(2512)	—	—	—	4,000
Current Sensing Resistors, Metal Plate Type	ERJ1W	6432(2512)	—	—	—	3,000
	ERJMS4	6432(2512)	—	—	—	2,000
High Power Chip Resistors/Wide Terminal Type	ERJMB1	2550(1020)	—	—	—	3,000
	ERJA1	3264(1225)	—	—	—	4,000
	ERJB1/ERJC1 ⁽¹⁾	2550(1020)	—	—	—	5,000
	ERJD1 ⁽²⁾	2550(1020)	—	—	—	5,000
	ERJB2/ERJD2 ⁽²⁾	1632(0612)	—	—	5,000	—
	ERJB3	1220(0508)	—	—	5,000	—

*W8P2 : Width 8 mm, Pitch 2 mm, ** W4P1 : Width 4 mm, Pitch 1 mm

(1) Anti-Sulfurated High Power Chip Resistors / Wide Terminal Type

(2) Low TCR High Power Chip Resistors / Wide Terminal Type

Surface Mount Resistors Series			Packaging (Standard Quantity : pcs/reel)			
Products	Part No.	Size mm (inch)	Pressed Carrier Taping (2 mm pitch)	Punched Carrier Taping (2 mm pitch)	Punched Carrier Taping (4 mm pitch)	Embossed Carrier Taping (4 mm pitch)
High Precision Thick Film Chip Resistors	ERJPB3	1608(0603)	—	—	5,000	—
	ERJPB6	2012(0805)	—	—	5,000	—
Anti-Surge Thick Film Chip Resistors	ERJPA2	1005(0402)	—	10,000	—	—
	ERJP03/PA3	1608(0603)	—	—	5,000	—
	ERJP06	2012(0805)	—	—	5,000	—
	ERJP08	3216(1206)	—	—	5,000	—
	ERJP14	3225(1210)	—	—	—	5,000
Anti-Pulse Thick Film Chip Resistors	ERJT06	2012(0805)	—	—	5,000	—
	ERJT08	3216(1206)	—	—	5,000	—
	ERJT14	3225(1210)	—	—	—	5,000
Anti-Sulfurated Thick Film Chip Resistors	ERJU0X	0402(01005)	20,000	—	—	—
	ERJU01	0603(0201)	15,000	—	—	—
	ERJS02/U02	1005(0402)	—	10,000	—	—
	ERJS03/U03	1608(0603)	—	—	5,000	—
	ERJS06/U06	2012(0805)	—	—	5,000	—
	ERJU6S/U6Q	2012(0805)	—	—	5,000	—
	ERJS08/U08	3216(1206)	—	—	5,000	—
	ERJS14/U14	3225(1210)	—	—	—	5,000
	ERJS12/U12	4532(1812)	—	—	—	5,000
	ERJS1D/U1D	5025(2010)	—	—	—	5,000
ERJS1T/U1T	6432(2512)	—	—	—	4,000	
Anti-Sulfurated Thick Film Chip Resistors / Precision Type	ERJU2R	1005(0402)	—	10,000	—	—
	ERJU3R	1608(0603)	—	—	5,000	—
	ERJU6R	2012(0805)	—	—	5,000	—
Anti-Sulfurated Thick Film Chip Resistors / Anti-Surge Type	ERJUP3	1608(0603)	—	—	5,000	—
	ERJUP6	2012(0805)	—	—	5,000	—
	ERJUP8	3216(1206)	—	—	5,000	—
Chip Resistor Array	EXB14V	0806(0302)	—	10,000	—	—
	EXB24V	1010(0404)	—	10,000	—	—
	EXB34V	1616(0606)	—	—	5,000	—
	EXBV4V	1616(0606)	—	—	5,000	—
	EXB18V	1406(0502)	—	10,000	—	—
	EXB28V	2010(0804)	—	10,000	—	—
	EXBN8V	2010(0804)	—	10,000	—	—
	EXB38V	3216(1206)	—	—	5,000	—
	EXBV8V	3216(1206)	—	—	5,000	—
	EXBS8V	5022(2009)	—	—	—	2,500
Anti-Sulfurated Chip Resistor Array	EXBU14	0806(0302)	—	10,000	—	—
	EXBU18	1406(0502)	—	10,000	—	—
	EXBU24	1010(0404)	—	10,000	—	—
	EXBU34	1616(0606)	—	—	5,000	—
	EXBU28	2010(0804)	—	10,000	—	—
	EXBU38	3216(1206)	—	—	5,000	—
	EXBU2H	3816(1506)	—	—	5,000	—
	EXBD	3216(1206)	—	—	5,000	—
Chip Resistor Networks	EXBE	4021(1608)	—	—	—	4,000
	EXBA	6431(2512)	—	—	—	4,000
	EXBQ	3816(1506)	—	—	5,000	—
	EXB14AT	0806(0302)	—	10,000	—	—
Chip Attenuator	EXB24AT	1010(0404)	—	10,000	—	—

Carrier Tape

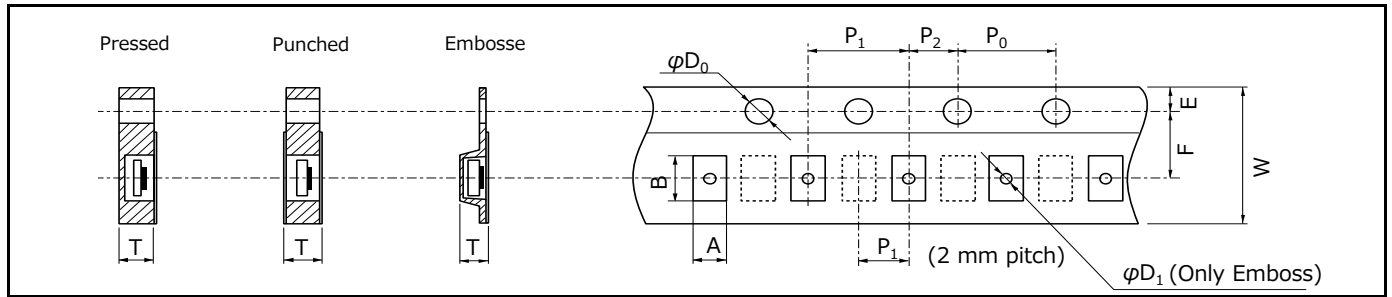

Pressed Carrier Taping (2 mm Pitch)

● Chip Resistors / Precision Chip / Metal Film(Thin Film)Chip / Low Resistance / Anti-Sulfurated (Unit : mm)

Part No.	Size mm (inch)	A	B	W	F	E	P ₁	P ₂	P ₀	φ D ₀	T
ERJXGN ERJUOX	0402	0.24±0.03	0.45±0.03	8.00±0.20	3.50±0.05	1.75±0.10	2.00±0.10	2.00±0.05	4.00±0.10	1.50 +0.10/0	0.31±0.05
ERJ1GN ERJ1R□ ERJU01 ERA1A	0603	0.38±0.05	0.68±0.05								0.42±0.05
ERJ2LW ERJ2BW	1005	0.68±0.10 0.67±0.10	1.20±0.10 1.17±0.10								0.60±0.05 0.61±0.05

Punched Carrier Taping (2 mm Pitch)

● Chip Resistors / Precision Chip / Metal Film(Thin Film)Chip / Low Resistance / Anti-Surge / Anti-Sulfur / Metal Foil Type (Unit : mm)

Part No.	Size mm (inch)	A	B	W	F	E	P ₁	P ₂	P ₀	φ D ₀	T
ERJ2□ ERJPA2 ERJ□□2 ERJ□2□ ERA2□	1005	0.67±0.05	1.17±0.05	8.00±0.20	3.50±0.05	1.75±0.10	2.00±0.10	2.00±0.05	4.00±0.10	1.50 +0.10/0	0.52±0.05

● Chip Resistor Array / Anti-Sulfurated Chip Resistor Array / Chip Attenuator (Unit : mm)

Part No.	Size mm (inch)	A	B	W	F	E	P ₁	P ₂	P ₀	φ D ₀	T
EXB14V EXB14AT	0806	0.70 +0.10/-0.05	0.95 +0.05/-0.10	8.00±0.20	3.50±0.05	1.75±0.10	2.00±0.10	2.00±0.05	4.00±0.10	1.50 +0.10/0	0.52±0.05
EXB18V EXB24V EXBU24 EXB24AT	1406 1010		1.60±0.10 1.20±0.10								
EXB28V EXBU28 EXBN8V	2010		2.20±0.10								

Punched Carrier Taping (4 mm Pitch)

● Chip Resistors / Precision Chip / Metal Film(Thin Film)Chip / Low Resistance / High Power / High Precision / Anti-Surge / Anti-Pulse / Anti-Sulfurated (Unit : mm)

Part No.	Size mm (inch)	A	B	W	F	E	P ₁	P ₂	P ₀	φ D ₀	T
ERJ3□ ERJ3LW(10mΩ) ERJ3BW ERJ□□3 ERJ□3□ ERA3□ ERJ3LW(5mΩ)	1608	1.10±0.10	1.90±0.10	8.00±0.20	3.50±0.05	1.75±0.10	4.00±0.10	2.00±0.05	4.00±0.10	1.50 +0.10/0	0.70±0.05
ERJ6□ ERJ□□6 ERJ□6□ ERA6□	2012	1.65±0.15	2.50±0.20								0.84±0.05
ERJB3 ERJ6BW ERJ6LW ERJ6C	1220 2012	1.55±0.15	2.30±0.20								0.94±0.05
ERJ8□ ERJ8□W ERJ□□8 ERA8□ ERJB2 ERJD2	3216 1632	2.00±0.15	3.60±0.20								0.84±0.05

● Chip Resistor Array / Anti-Sulfurated Chip Resistor Array / Chip Resistor Networks

(Unit : mm)

Part No.	Size mm (inch)	A	B	W	F	E	P ₁	P ₂	P ₀	φ D ₀	T	
EXB34V	1616	1.95±0.15	1.95±0.20	8.00±0.20	3.50±0.05	1.75±0.10	4.00±0.10	2.00±0.05	4.00±0.10	1.50 +0.10/0	0.70±0.05	
EXBU34	3216		3.60±0.20									
EXB38V	3816		4.10±0.15									
EXB2HV	1616		1.95±0.20								0.84±0.05	
EXBU2H	3216		3.60±0.20									
EXBV4V	3216		2.00±0.20								3.60±0.20	0.84±0.10
EXBV8V	3816		1.90±0.20								4.10±0.20	0.64±0.05

Embossed Carrier Taping (1 mm Pitch)

● Chip Resistors

(Unit : mm)

Part No.	Size mm (inch)	A	B	W	F	E	P ₁	P ₂	P ₀	φ D ₀	T
ERJXGN	0402	0.25±0.05	0.45±0.05	4.00±0.20	1.80±0.05	0.90±0.10	1.00±0.10	1.00±0.10	2.00±0.10	0.80±0.10	0.5 max.

Embossed Carrier Taping (4 mm Pitch)

● Chip Resistors / Precision Chip / Low Resistance / High Power / Anti-Surge / Anti-Pulse / Anti-Sulfurated

(Unit : mm)

Part No.	Size mm (inch)	A	B	W	F	E	P ₁	P ₂	P ₀	φ D ₀	T	φ D ₁	
ERJ14□	3225	2.80±0.20	3.50±0.20	8.00±0.30	3.50±0.05	1.75 ±0.10	4.00 ±0.10	2.00 ±0.05	4.00 ±0.10	1.50 +0.10/0	1.00±0.10	1.00 +0.10/0	
ERJ□14	4532	3.50±0.20	4.80±0.20	12.00 ±0.30	5.50±0.20							15 min.	
ERJ12□													
ERJ12Z	5025	2.80±0.20	5.30±0.20										
ERJ12S													
ERJ□1D													
ERJB1	2550	3.60±0.20	6.90±0.20										1.60±0.10
ERJC1													
ERJD1	6432	3.50±0.20	6.80±0.20			1.10±0.20							
ERJ1T□													
ERJ□1T													
ERJL1W	3264	3.50±0.20	6.80±0.20	1.10±0.20									
ERJA1													

● Current Sensing Resistors, Metal Plate Type

(Unit : mm)

Part No.	Size mm (inch)	A	B	W	F	E	P ₁	P ₂	P ₀	φ D ₀	T	φ D ₁
ERJMB1	2550	2.90±0.20	5.40±0.20	12.00 ±0.30	5.50±0.10	1.75 ±0.10	4.00 ±0.10	2.00 ±0.05	4.00 ±0.10	1.50 +0.10/0	1.55±0.20	—
ERJMS4	6432	3.50±0.20	6.90±0.20	12.00 ±0.30	5.50±0.10						1.60±0.20	1.5 min.

● Chip Resistor Array / Chip Resistor Networks

(Unit : mm)

Part No.	Size mm (inch)	A	B	W	F	E	P ₁	P ₂	P ₀	φ D ₀	T	φ D ₁
EXBS8V	5022	2.80±0.20	5.70±0.20	12.00 ±0.30	5.50±0.20	1.75 ±0.10	4.00 ±0.10	2.00 ±0.05	4.00 ±0.10	1.50 +0.10/0	1.6 max.	1.5 min.
EXBE	4021	2.50±0.20	4.40±0.20								1.10±0.20	
EXBA	6431	3.50±0.20	6.80±0.20									

Taping Reel

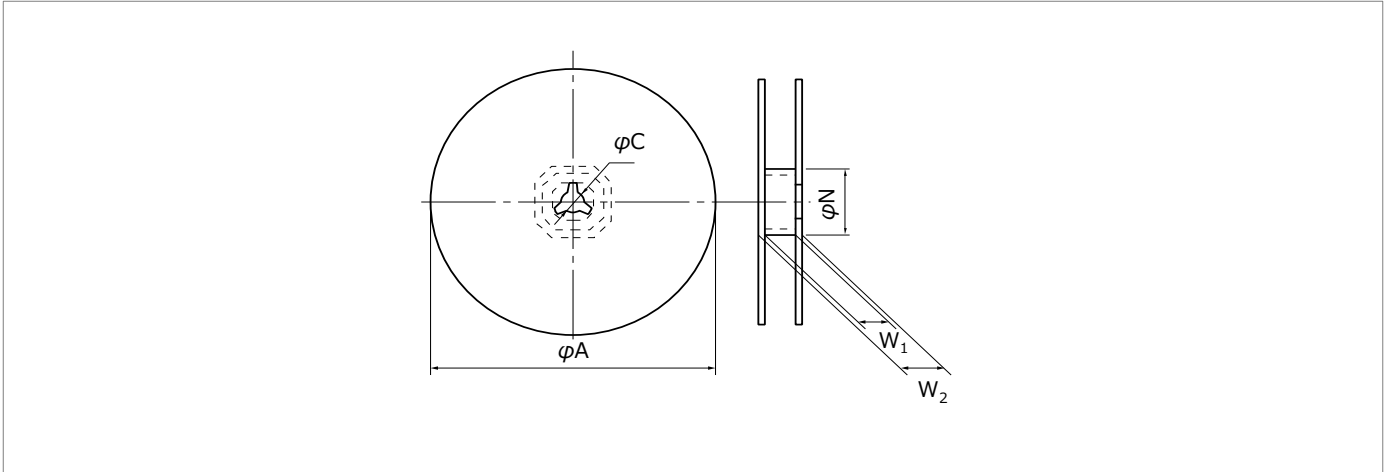

Tape width(W)	Dimensions (mm)				
	ϕA	ϕN	ϕC	W_1	W_2
4 mm width	180.0 ± 3.0	$60.0 + 1.0 / 0$	13.0 ± 0.2	4.5 ± 0.5	7.0 ± 0.5
8 mm width	$180.0 \ 0 / -1.5$			$9.0 + 1.0 / 0$	11.4 ± 1.0
12 mm width				$13.0 + 1.0 / 0$	15.4 ± 1.0
24 mm width	380.0 ± 2.0	80.0 ± 1.0		25.4 ± 1.0	29.4 ± 1.0

Recommended Land Pattern

- An example of a land pattern for the Rectangular Type is shown below.

<Ex.>

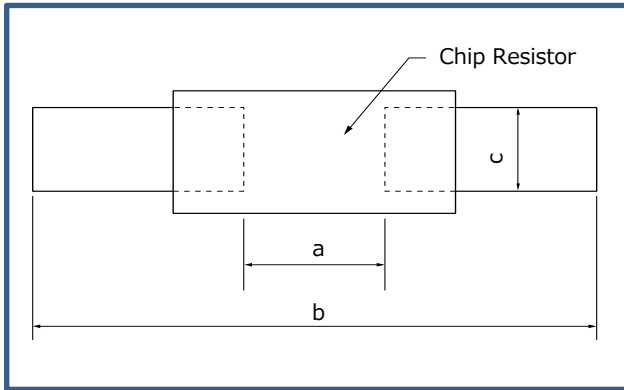

Size mm/inch	Dimensions(mm)		
	a	b	c
0402/01005	0.15 to 0.20	0.5 to 0.7	0.20 to 0.25
0603/0201	0.3 to 0.4	0.8 to 0.9	0.25 to 0.35
1005/0402	0.5 to 0.6	1.4 to 1.6	0.4 to 0.6
1608/0603	0.7 to 0.9	2.0 to 2.2	0.8 to 1.0
2012/0805	1.0 to 1.4	3.2 to 3.8	0.9 to 1.4
3216/1206	2.0 to 2.4	4.4 to 5.0	1.2 to 1.8
3225/1210	2.0 to 2.4	4.4 to 5.0	1.8 to 2.8
4532/1812	3.3 to 3.7	5.7 to 6.5	2.3 to 3.5
5025/2010	3.6 to 4.0	6.2 to 7.0	1.8 to 2.8
6432/2512	5.0 to 5.4	7.6 to 8.6	2.3 to 3.5
6432/2512*	3.6 to 4.0	7.6 to 8.6	2.3 to 3.5

* ERJL1W

High power (double-sided resistive elements structure) type

Part No.	Size mm inch	Dimensions(mm)		
		a	b	c
ERJ2LW/2BW	1005 0402	0.52	1.4 to 1.6	0.4 to 0.6
ERJ3LW/3BW	1608 0603	0.5 to 0.8	2.5 to 2.7	0.9 to 1.1
ERJ6LW	2012 0805	0.6 to 0.8	3.2 to 3.8	1.1 to 1.4
ERJ6BW		0.9	3.2 to 3.8	1.1 to 1.4
ERJ6CW (10 to 13 mΩ)		0.7 to 0.9	3.2 to 3.8	1.1 to 1.4
ERJ6CW (15 to 30 mΩ)		0.9 to 1.1	3.2 to 3.8	1.1 to 1.4
ERJ8BW	3216 1206	1.2	4.4 to 5.0	1.3 to 1.8
ERJ8CW (10 to 16 mΩ)				
ERJ8CW (18 to 50 mΩ)				

- An example of a land pattern for High Power Chip Resistors / Wide Terminal Type is shown below.

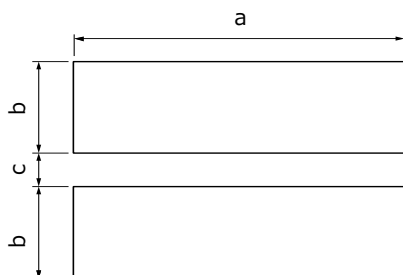

Part No.	Dimensions(mm)		
	a	b	c
ERJA1	6.4	1.70	0.60
ERJB1	5.0	1.30	0.75
ERJC1 ⁽¹⁾			
ERJD1 ⁽²⁾	3.2	0.95	0.70
ERJB2			
ERJD2 ⁽²⁾			
ERJB3	2.0	0.80	0.60

(1) Anti-Sulfurated High Power Chip Resistors/Wide Terminal Type

(2) Low TCR High Power Chip Resistors/Wide Terminal Type

Recommended Land Pattern

- An example of a land pattern for Chip Resistor Array, Anti-Sulfurated Chip Resistor Array and Chip Attenuator is shown below.

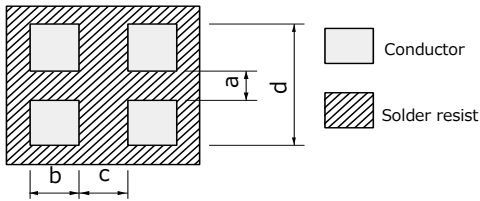

Part No.	Dimensions(mm)			
	a	b	c	d
EXB14V EXB14A	0.30	0.30	0.30	0.80 to 0.90
EXB24V EXBU24 EXB24A	0.5	0.35 to 0.40	0.30	1.4 to 1.5

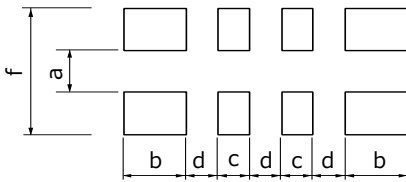

Part No.	Dimensions(mm)				
	a	b	c	d	f
EXB28V EXBU28	0.40	0.525	0.25	0.25	1.40
EXBN8V	0.45 to 0.50	0.35 to 0.38	0.25	0.25	1.40 to 2.00

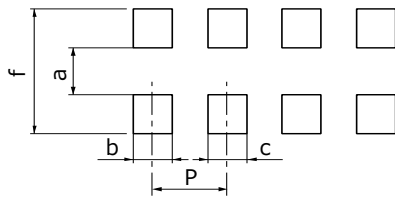

Part No.	Dimensions(mm)				
	a	b	c	f	P
EXB18V	0.20 to 0.30	0.15 to 0.20	0.15 to 0.20	0.80 to 0.90	0.40
EXBV4V EXBV8V	0.7 to 0.9	0.4 to 0.45	0.4 to 0.45	2 to 2.4	0.80
EXB34V EXB38V EXBU34 EXBU38	0.7 to 0.9	0.4 to 0.5	0.4 to 0.5	2.2 to 2.6	0.80
EXBS8V	1 to 1.2	0.5 to 0.75	0.5 to 0.75	3.2 to 3.8	1.27

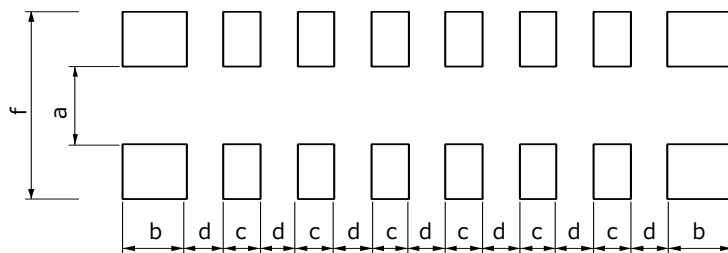

Part No.	Dimensions(mm)				
	a	b	c	d	f
EXB2HV EXBU2H	1.00	0.425	0.25	0.25	2.00

Recommended Land Pattern

- An example of a land pattern for Chip Resistor Networks is shown below.

	EXBA	EXBE
For popular pattern	<p>Pitch 1.27 mm</p>	<p>Pitch 0.8 mm</p>
For high density pattern*	<p>Pitch 0.635 mm Through-hole less</p> <p>EXBA10P EXBA10E</p>	<p>Pitch 0.8 mm Through-hole less</p>
	EXBD	EXBQ
For popular pattern	<p>Pitch 0.635 mm</p>	<p>Pitch 0.5 mm</p>

* When designing high density land patterns, examine the reliability of isolation among the lines and adopt the chip resistor networks.

Recommended Soldering Conditions

Recommendations and precautions are described below.

● Rectangular Type

● **Recommended soldering conditions for reflow**

- Reflow soldering shall be performed a maximum of two times.
- Please contact us for additional information when used in conditions other than those specified.
- Please measure the temperature of the terminals and study every kind of solder and printed circuit board for solderability before actual use.

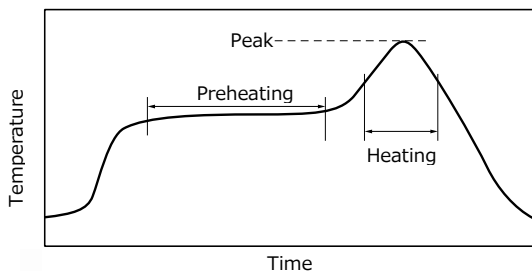

For soldering (Example : Sn/Pb)

	Temperature	Time
Preheating	140 °C to 160 °C	60 s to 120 s
Main heating	Above 200 °C	30 s to 40 s
Peak	235 ± 5 °C	max. 10 s

For lead-free soldering (Example : Sn/Ag/Cu)

	Temperature	Time
Preheating	150 °C to 180 °C	60 s to 120 s
Main heating	Above 230 °C	30 s to 40 s
Peak	max. 260 °C	max. 10 s

● **Recommended soldering conditions for flow**

	For soldering		For lead-free soldering	
	Temperature	Time	Temperature	Time
Preheating	140 °C to 160 °C	60 s to 120 s	150 °C to 180 °C	60 s to 120 s
Soldering	245 ± 5 °C	20 s to 30 s	max. 260 °C	max. 10 s

● Chip Resistor Array, Chip Resistor Networks and Chip Attenuator

● **Recommended soldering conditions for reflow**

- Reflow soldering shall be performed a maximum of two times.
- Please contact us for additional information when used in conditions other than those specified.
- Please measure the temperature of the terminals and study every kind of solder and printed circuit board for solderability before actual use.

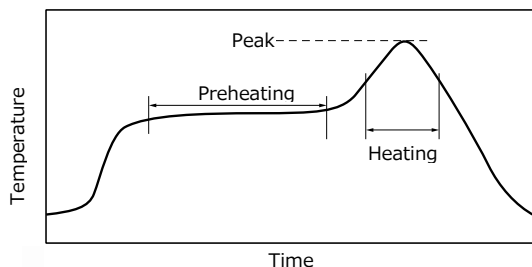

For soldering (Example : Sn/Pb)

	Temperature	Time
Preheating	140 °C to 160 °C	60 s to 120 s
Main heating	Above 200 °C	30 s to 40 s
Peak	235 ± 5 °C	max. 10 s

For lead-free soldering (Example : Sn/Ag/Cu)

	Temperature	Time
Preheating	150 °C to 180 °C	60 s to 120 s
Main heating	Above 230 °C	30 s to 40 s
Peak	max. 260 °C	max. 10 s

● **Flow soldering**

We do not recommend flow soldering, because a solder bridge may form. Please contact us regarding flow soldering of EXBA series.

Standard for Resistance Value and Resistance Tolerance

Basis Standard

IEC Publication 60062: Marking codes for resistors and capacitors.

IEC Publication 60063: Preferred number series for resistors and capacitors.

JIS C 5062: Marking codes for resistors and capacitors.

JIS C 5063: Preferred number series for resistors and capacitors.

Resistance Values

The resistance values are notched by "Ratio" below in each series.

Series	Resistance Tolerance (Standard)	Ratio	Remarks
E6	±20 %	${}^6\sqrt{10}=1.46$	Please refer to standard resistance values shown on this catalog.
E12	±10 %	${}^{12}\sqrt{10}=1.21$	
E24	± 5 %	${}^{24}\sqrt{10}=1.10$	
E48	± 2 %	${}^{48}\sqrt{10}=1.05$	
E96	± 1 %	${}^{96}\sqrt{10}=1.02$	

How to express the resistance value with a Panasonic part number

The resistance value expressed in ohms is identified by a three digit number or a four digit number.

The last digit specifies the number of zeroes to follow.

The letter "R" shall be used as the decimal point for less than 10 Ω.

The examples of a three digit number

Resistance Code	Value in ohms (Ω)
R56	0.56
5R6	5.6
100	10
271	270
102	1 k
273	27 k
104	100 k
275	2.7 M
106	10 M
107	100 M

The examples of a four digit number

Resistance Code	Value in ohms (Ω)
R562	0.562
5R62	5.62
56R2	56.2
1000	100
2711	2.71 k
1002	10 k
2713	271 k
1004	1 M
2751	2.71 M
1006	100 M

How to express the resistance tolerance with a Panasonic part number

The resistance tolerance is identified by a single letter in accordance with the following table and the code is placed just before the resistance code in the following examples.

Tolerance Code	Tolerance (%)	Examples
W	±0.05	W1001 : 1000 Ω±0.05 %
B	±0.1	B1001 : 1000 Ω±0.1 %
C	±0.25	C1001 : 1000 Ω±0.25 %
D	±0.5	D1001 : 1000 Ω±0.5 %
F	±1	F1001 : 1000 Ω±1 %
G	±2	G1001 : 1000 Ω±2 %
J	±5	J101 : 100 Ω±5 %
K	±10	K101 : 100 Ω±10 %
M	±20	M101 : 100 Ω±20 %

Standard Resistance Values

E6	E12	E24	E48	E96	E6	E12	E24	E48	E96	E6	E12	E24	E48	E96	
10	10	10	100	100	22	22	22	215	215	47	47	47	464	464	
			102	221				475							
			105	226				487							
			107	232				499							
			110	237				511							
		11	110	110	24	237	237	51	511	511					
			113	243		523									
			115	249		536									
			118	255		549									
			121	261		562									
	12	12	121	121	27	27	27	261	261	56	56	56	562	562	
			124	267				576							
			127	274				590							
			130	280				604							
			133	287				619							
		13	13	133	133	30	30	30	301	301	62	62	62	619	619
				137	294				634						
				140	301				649						
				143	309				665						
				147	316				681						
15	15	150	150	33	33	33	316	316	68	68	68	681	681		
		154	324				698								
		158	332				715								
		162	340				732								
		165	348				750								
	16	16	162	162	36	36	36	348	348	75	75	75	750	750	
			165	357				768							
			169	365				787							
			174	374				806							
			178	383				825							
18	18	178	178	39	39	39	383	383	82	82	82	825	825		
		182	392				845								
		187	402				866								
		191	412				887								
		196	422				909								
	20	20	196	196	43	43	43	422	422	91	91	91	909	909	
			200	432				931							
			205	442				953							
			210	453				976							

CAUTION AND WARNING

1. The electronic components contained in this catalog are designed and produced for use in home electric appliances, office equipment, information equipment, communications equipment, and other general purpose electronic devices. Before use of any of these components for equipment that requires a high degree of safety, such as medical instruments, aerospace equipment, disaster-prevention equipment, security equipment, vehicles (automobile, train, vessel), please be sure to contact our sales representative corporation.
2. When applying one of these components for equipment requiring a high degree of safety, no matter what sort of application it might be, be sure to install a protective circuit or redundancy arrangement to enhance the safety of your equipment. In addition, please carry out the safety test on your own responsibility.
3. When using our products, no matter what sort of equipment they might be used for, be sure to make a written agreement on the specifications with us in advance.
4. Technical information contained in this catalog is intended to convey examples of typical performances and or applications and is not intended to make any warranty with respect to the intellectual property rights or any other related rights of our company or any third parties nor grant any license under such rights.
5. In order to export products in this catalog, the exporter may be subject to the export license requirement under the Foreign Exchange and Foreign Trade Law of Japan.
6. No ozone-depleting substances (ODSs) under the Montreal Protocol are used in the manufacturing processes of Automotive & Industrial Systems Company, Panasonic Corporation.

● Please contact

● Factory

Device Solutions Business Division
Industrial Solutions Company

Panasonic[®]

1006 Kadoma, Kadoma City, Osaka 571-8506,
JAPAN

The information in this catalog is valid as of September 2020.

X-ON Electronics

Largest Supplier of Electrical and Electronic Components

Click to view similar products for [Thick Film Resistors - SMD category](#):

Click to view products by [Panasonic manufacturer](#):

Other Similar products are found below :

[CR-05FL7--19K6](#) [CR-05FL7--243R](#) [CR-05FL7--40K2](#) [CR-12JP4--680R](#) [CRCW04021K20FKEE](#) [CRCW06036K80FKEE](#)

[M55342K06B2E94RS2](#) [M55342K06B309DRS3](#) [M55342K06B6E81RS3](#) [M55342K08B100DRWB](#) [M55342M05B200DRWB](#)

[M55342M06B26E7RS3](#) [MC0603-511-JTW](#) [742C083750JTR](#) [MCR01MZPF1202](#) [MCR01MZPF1601](#) [MCR01MZPF1800](#) [MCR01MZPF6201](#)

[MCR01MZPF9102](#) [MCR01MZPJ113](#) [MCR01MZPJ121](#) [MCR01MZPJ125](#) [MCR01MZPJ203](#) [MCR01MZPJ751](#) [MCR01MZPJ822](#)

[MCR03EZHJ103](#) [MCR03EZPFX1272](#) [MCR03EZPJ123](#) [MCR03EZPJ270](#) [MCR03EZPJ821](#) [MCR10EZPF1102](#) [MCR10EZPF2003](#)

[MCR10EZPF2700](#) [MCR18EZPJ330](#) [RC0603F1473CS](#) [RC0603F150CS](#) [RC1005F1152CS](#) [RC1005F1182CS](#) [RC1005F1372CS](#)

[RC1005F183CS](#) [RC1005F1911CS](#) [RC1005F1912CS](#) [RC1005F203CS](#) [RC1005F2052CS](#) [RC1005F241CS](#) [RC1005F2431CS](#)

[RC1005F3011CS](#) [RC1005F303CS](#) [RC1005F4321CS](#) [RC1005F4642CS](#)