



Current Sensing Resistors, Metal Plate Type

Series:
ERJ MP2, MP3, MP4

Discontinued

NRFND Replacement
ERJMP2,MP3 → ERJMB1
ERJMP4 → ERJMS4

Features

- Ideal for current sensing solution
- Small case size with high power
- Metal plate bonding technology. Excellent long term stability
- Outer Resin with high heat dissipation. Wide temperature range (-65 °C to +170 °C)
- AEC-Q200 compliant
- RoHS compliant
- ISO9001, ISO/TS16949 certified

■ As for Packaging Methods, Soldering Conditions and Safety Precautions,
Please see Data Files

Explanation of Part Numbers

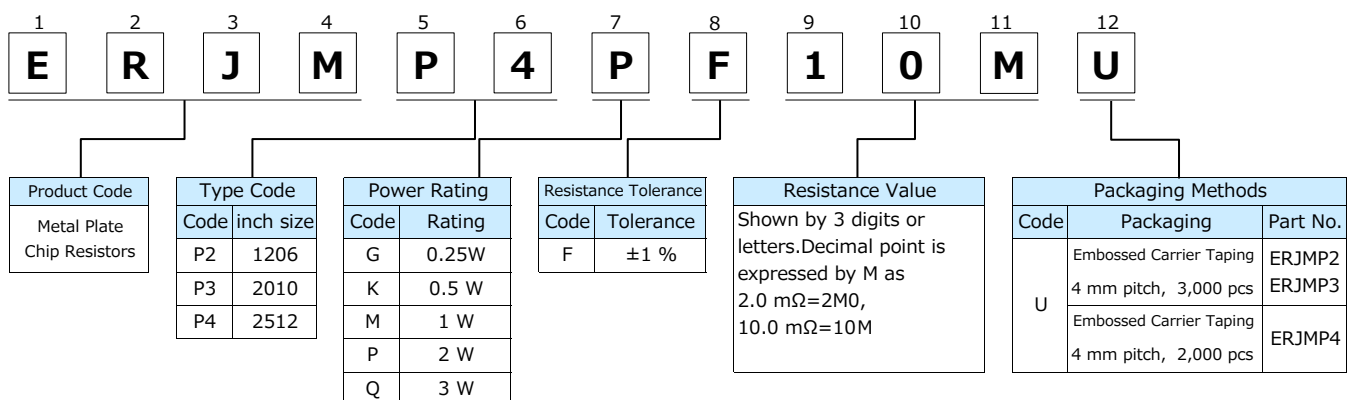

Ratings

Part No. (inch size)	Power Rating at 70 °C (W)	Resistance Range* (mΩ)	Resistance Tolerance (%)	T.C.R. (×10 ⁻⁶ /K)	Category Temperature Range (°C)
ERJMP2G (1206)	0.25	1, 2, 3, 5, 10, 15	F : ±1	±75	-65 to +170
ERJMP2K (1206)	0.5				
ERJMP2M (1206)	1				
ERJMP3K (2010)	0.5				
ERJMP3M (2010)	1				
ERJMP3P (2010)	2				
ERJMP4M (2512)	1				
ERJMP4P (2512)	2				
ERJMP4Q (2512)	3				

* Please contact us when resistors of irregular series are needed.

Power Derating Curve

If the ambient terminal temperature of the resistor is more than ambient temperature upper limit value of the rated table, please reduce the rated power according to the Power Derating Curve shown in the figure on the right.

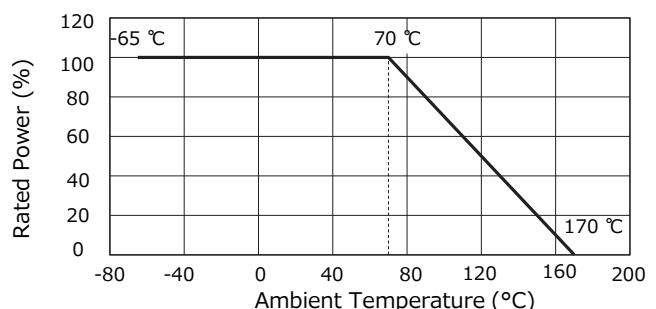

Construction

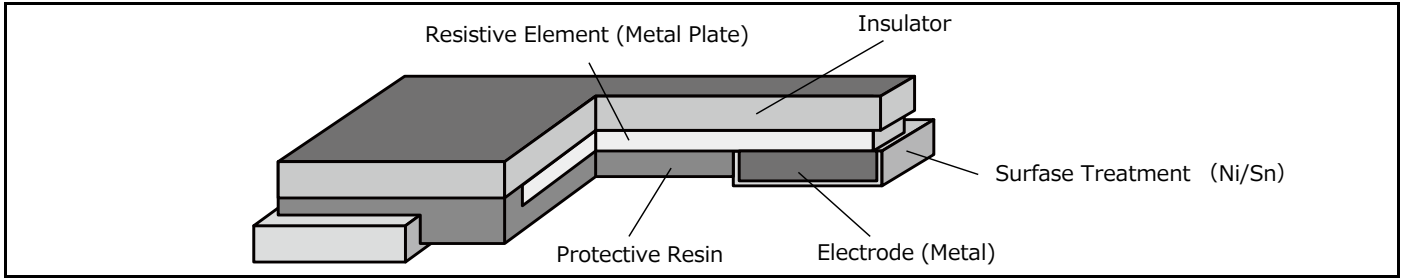

Dimensions in mm (not to scale), Recommended Land Pattern

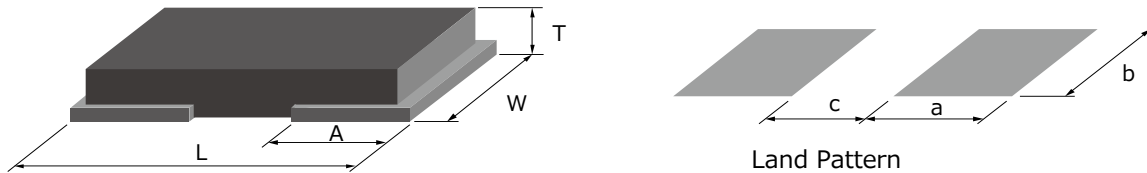

Part No. (inch size)	Rating Code	Resistance Value (mΩ)	Dimensions (mm)				Recommended Land Pattern (mm)			Mass (Weight) (g/1000 pcs)
			L	W	A	T	a	b	c	
ERJMP2 (1206)	G, K, M	1	3.20±0.25	1.60±0.25	1.04±0.25	1.00±0.25	1.5	1.8	1.0	30
		2			0.64±0.25					
		3, 5			0.50±0.25	0.64±0.25	1.1	1.8	1.8	
		10, 15								
ERJMP3 (2010)	K, M, P	1	5.00±0.25	2.50±0.25	1.47±0.25	0.90±0.25	2.1	3.1	1.9	70
		2, 3, 5			0.50±0.25	0.64±0.25				
		10, 15				0.64±0.25	1.3	3.1	3.5	
ERJMP4 (2512)	M, P, Q	1	6.40±0.25	3.20±0.25	2.20±0.25	0.90±0.25	3.0	3.4	2.0	100
		2, 3			0.76±0.25	0.74±0.25				
		5				0.64±0.25				
	M, P Q	10, 15			0.64±0.25	2.0	3.4	4.0		
					0.83±0.25					

Typical Temperature dependence of electrical resistance

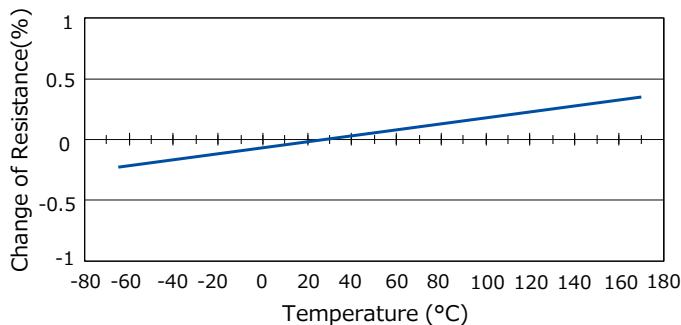

Long-term stability

● Load Life 70 °C, Rated power

○ ERJMP2MF5M0U □ ERJMP4QF5M0U
 △ ERJMP3PF5M0U

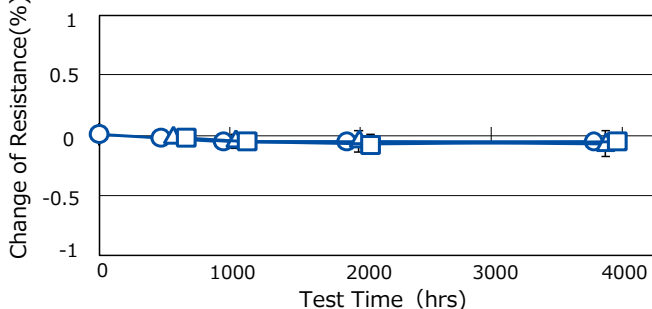

● Thermal Shock -55 °C /155 °C

○ ERJMP2MF5M0U □ ERJMP4QF5M0U
 △ ERJMP3PF5M0U

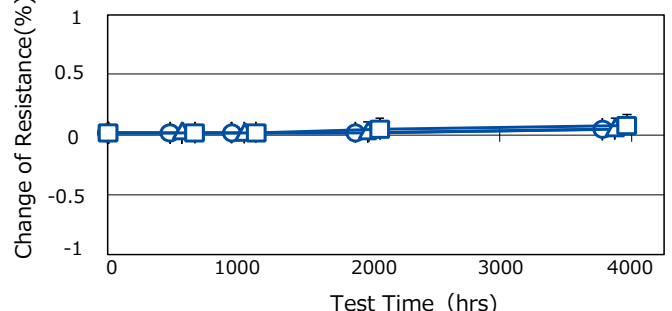

Maximum pulse energy respectively pulse power for continuous operation

Reference Data

Condition : Room Temperature, OFF : 10 s, 1000 cycle, Wave form : Square, Change of Resistance=±1 %

● ERJMP2

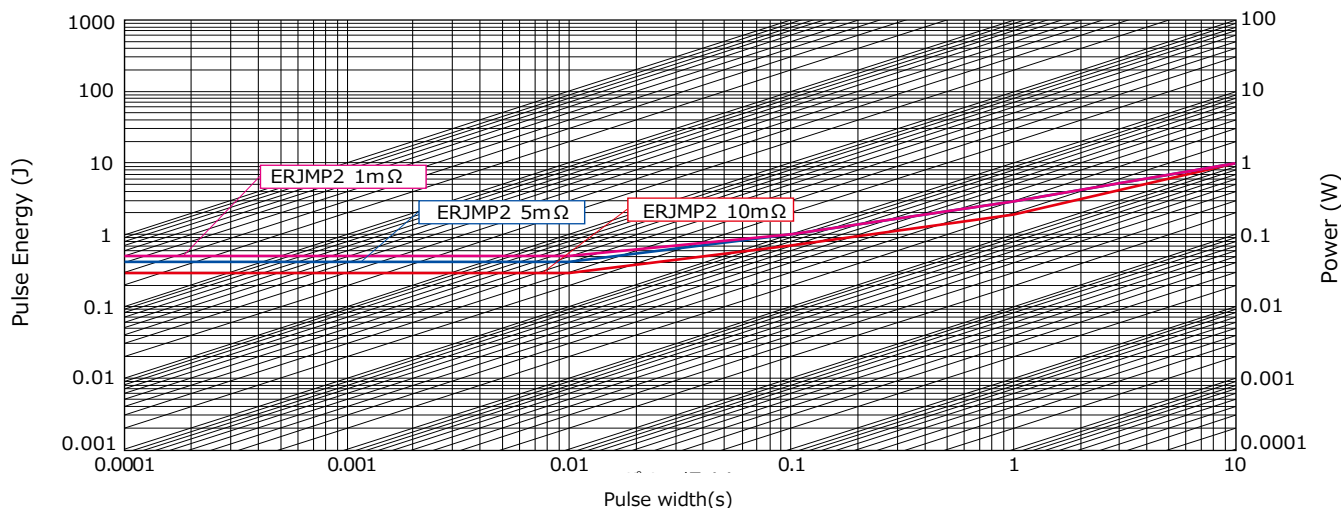

● ERJMP3

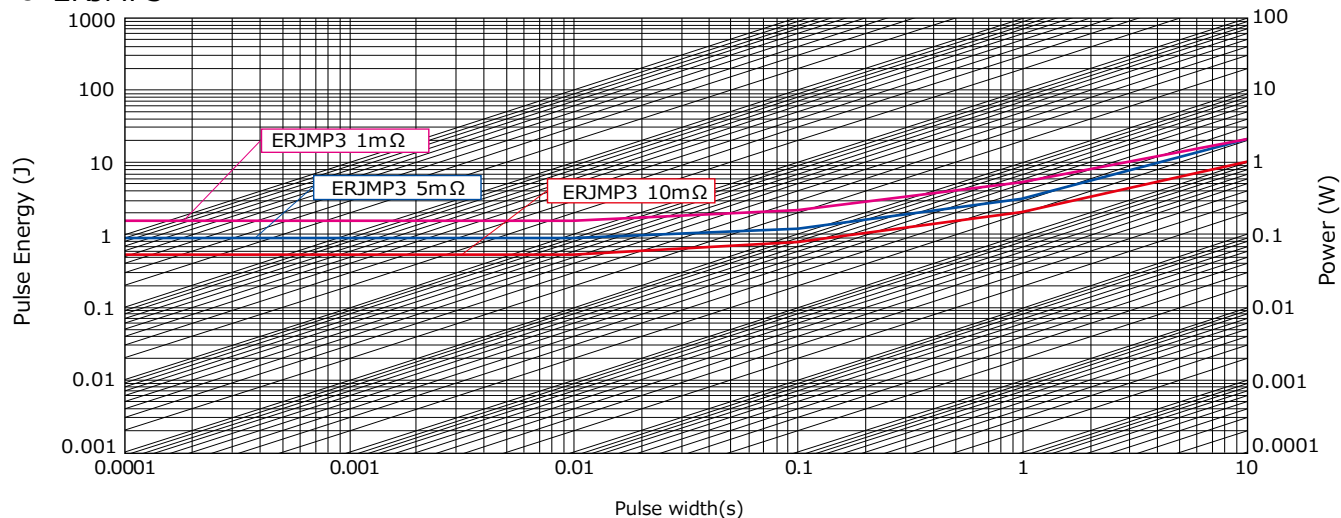

● ERJMP4

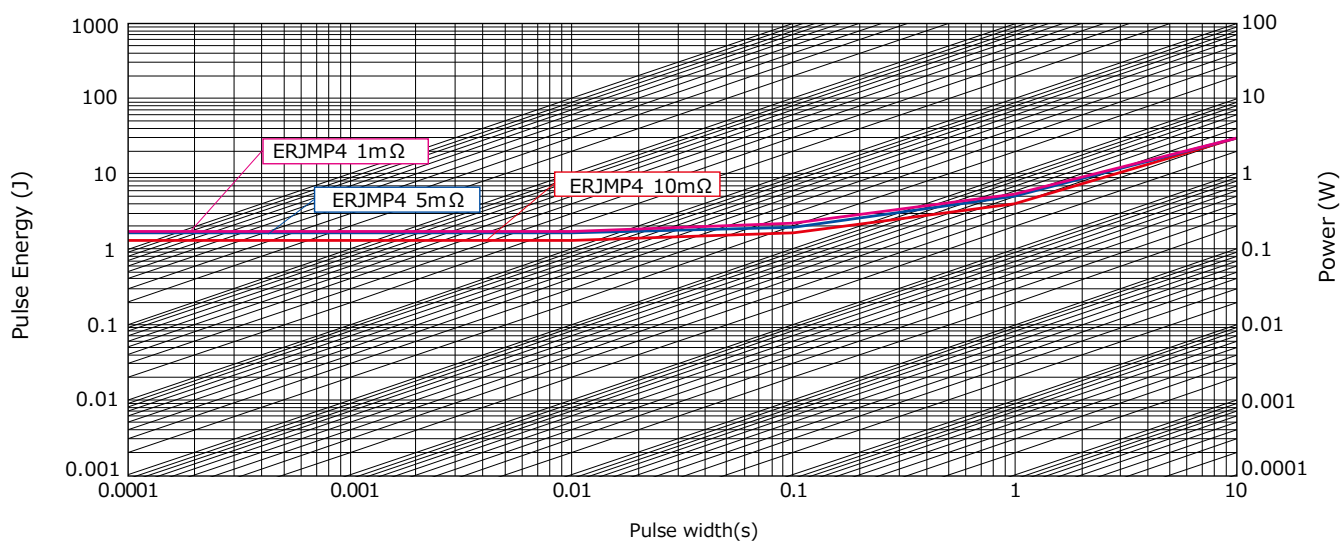

This pulse data is reference characteristic data measured under Panasonic test method and it does not guarantee the performance / characteristics of this product. (The performance / characteristics will change due to the test board, land pattern, amount and type of solder, influence of test equipment and surrounding parts, etc.)

Therefore, please use it after sufficiently confirming its reliability under your using conditions.

Performance (AEC-Q200)

Test Item	Performance Requirements ΔR	Typical value ΔR	Test Condition
Thermal Shock	$\pm 1 \%$	0.20 %	-55 °C / +155 °C, 1000 cycles
Overload	$\pm 0.5 \%$	0.10 %	Rated Power $\times 3$, 5 s
Solderability	> 95% coverage	> 95% coverage	245 °C, 3 s
Resistance to Solvents	No damage	No damage	MIL-STD-202 method 215, 2.1a, 2.1d
Low Temperature Storage and Operation	$\pm 0.5 \%$	0.03 %	-65 °C, 24 h
Resistance to Soldering Heat	$\pm 0.5 \%$	0.10 %	MIL-STD-202 method 210 (260 °C, 10 s)
Moisture Resistance	$\pm 0.5 \%$	0.10 %	MIL-STD-202 method 106
Shock	$\pm 0.5 \%$	0.10 %	MIL-STD-202 method 213-A
Vibration, High Frequency	$\pm 0.5 \%$	0.05 %	10 to 2000 (Hz)
Life	$\pm 1 \%$	0.30 %	70 °C, Rated Power, 2000 h
Storage Life at Elevated Temperature	$\pm 1 \%$	0.30 %	170 °C, 2000 h
High Temperature Characteristics	$\pm 0.5 \%$	0.05 %	140 °C, 2000 h
Frequency Characteristics	< 5 nH	< 2 nH	Inductance

Sense terminal-Layout

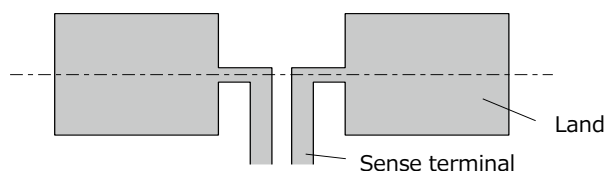

Guidelines and precautions regarding the technical information and use of our products described in this online catalog.

- If you want to use our products described in this online catalog for applications requiring special qualities or reliability, or for applications where the failure or malfunction of the products may directly jeopardize human life or potentially cause personal injury (e.g. aircraft and aerospace equipment, traffic and transportation equipment, combustion equipment, medical equipment, accident prevention, anti-crime equipment, and/or safety equipment), it is necessary to verify whether the specifications of our products fit to such applications. Please ensure that you will ask and check with our inquiry desk as to whether the specifications of our products fit to such applications use before you use our products.
- The quality and performance of our products as described in this online catalog only apply to our products when used in isolation. Therefore, please ensure you evaluate and verify our products under the specific circumstances in which our products are assembled in your own products and in which our products will actually be used.
- If you use our products in equipment that requires a high degree of reliability, regardless of the application, it is recommended that you set up protection circuits and redundancy circuits in order to ensure safety of your equipment.
- The products and product specifications described in this online catalog are subject to change for improvement without prior notice. Therefore, please be sure to request and confirm the latest product specifications which explain the specifications of our products in detail, before you finalize the design of your applications, purchase, or use our products.
- The technical information in this online catalog provides examples of our products' typical operations and application circuits. We do not guarantee the non-infringement of third party's intellectual property rights and we do not grant any license, right, or interest in our intellectual property.
- If any of our products, product specifications and/or technical information in this online catalog is to be exported or provided to non-residents, the laws and regulations of the exporting country, especially with regard to security and export control, shall be observed.

<Regarding the Certificate of Compliance with the EU RoHS Directive/REACH Regulations>

- The switchover date for compliance with the RoHS Directive/REACH Regulations varies depending on the part number or series of our products.
- When you use the inventory of our products for which it is unclear whether those products are compliant with the RoHS Directive/REACH Regulation, please select "Sales Inquiry" in the website inquiry form and contact us.

We do not take any responsibility for the use of our products outside the scope of the specifications, descriptions, guidelines and precautions described in this online catalog.

Safety Precautions (Common precautions for Fixed Resistors)

- When using our products, no matter what sort of equipment they might be used for, be sure to make a written agreement on the specifications with us in advance. The design and specifications in this catalog are subject to change without prior notice.
- Do not use the products beyond the specifications described in this catalog.
- This catalog explains the quality and performance of the products as individual components. Before use, check and evaluate their operations when installed in your products under the actual conditions for use.
- Install the following systems for a failsafe design to ensure safety if these products are to be used in equipment where a defect in these products may cause the loss of human life or other significant damage, such as damage to vehicles (automobile, train, vessel), traffic lights, medical equipment, aerospace equipment, electric heating appliances, combustion/gas equipment, rotating equipment, and disaster/crime prevention equipment.
 - * Systems equipped with a protection circuit and a protection device.
 - * Systems equipped with a redundant circuit or other system to prevent an unsafe status in the event of a single fault.
 - * Systems equipped with an arresting the spread of fire or preventing glitch.

(1) Precautions for use

- These products are designed and manufactured for general and standard use in general electronic equipment (e.g. AV equipment, home electric appliances, office equipment, information and communication equipment). For applications in which special quality and reliability are required, or if the failure or malfunction of the products may directly jeopardize life or cause threat of personal injury (such as for aircraft and aerospace equipment, traffic and transport equipment, combustion equipment, medical equipment, accident prevention and anti-theft devices, and safety equipment), please be sure to consult with our sales representative in advance and to exchange product specifications which conform to such applications.
- These products are not intended for use in the following special conditions. Before using the products, carefully check the effects on their quality and performance, and determine whether or not they can be used.
 1. In liquid, such as water, oil, chemicals, or organic solvent.
 2. In direct sunlight, outdoors, or in dust.
 3. In salty air or air with a high concentration of corrosive gas, such as Cl_2 , H_2S , NH_3 , SO_2 , or NO_x .
 4. Electric Static Discharge (ESD) Environment.

These components are sensitive to static electricity and can be damaged under static shock (ESD). Please take measures to avoid any of these environments.
Smaller components are more sensitive to ESD environment.
 5. Electromagnetic and Radioactive Environment.

Avoid any environment where strong electromagnetic waves and radiation exist.
 6. In an environment where these products cause dew condensation.
 7. Sealing or coating of these products or a printed circuit board on which these products are mounted, with resin or other materials.
- These products generate Joule heat when energized. Carefully position these products so that their heat will not affect the other components.
- Carefully position these products so that their temperatures will not exceed the category temperature range due to the effects of neighboring heat-generating components. Do not mount or place heat-generating components or inflammables, such as vinyl-coated wires, near these products.
- Note that non-cleaning solder, halogen-based highly active flux, or water-soluble flux may deteriorate the performance or reliability of the products.
- Carefully select a flux cleaning agent for use after soldering. An unsuitable agent may deteriorate the performance or reliability. In particular, when using water or a water-soluble cleaning agent, be careful not to leave water residues. Otherwise, the insulation performance may be deteriorated.
- Do not apply flux to these products after soldering. The activity of flux may be a cause of failures in these products.
- Refer to the recommended soldering conditions and set the soldering condition. High peak temperature or long heating time may impair the performance or the reliability of these products.
- Recommended soldering condition is for the guideline for ensuring the basic characteristics of the products, not for the stable soldering conditions. Conditions for proper soldering should be set up according to individual conditions.

- Do not reuse any products after removal from mounting boards.
- Do not drop these products. If these products are dropped, do not use them. Such products may have received mechanical or electrical damage.
- If any doubt or concern to the safety on these products arise, make sure to inform us immediately and conduct technical examinations at your side.

(2) Precautions for storage

The performance of these products, including the solderability, is guaranteed for a year from the date of arrival at your company, provided that they remain packed as they were when delivered and stored at a temperature of 5 °C to 35 °C and a relative humidity of 45 % to 85 %.

Even within the above guarantee periods, do not store these products in the following conditions. Otherwise, their electrical performance and/or solderability may be deteriorated, and the packaging materials (e.g. taping materials) may be deformed or deteriorated, resulting in mounting failures.

1. In salty air or in air with a high concentration of corrosive gas, such as Cl₂, H₂S, NH₃, SO₂, or NO_x.
2. In direct sunlight.

(3) AEC-Q200 Compliant

The products are tested based on all or part of the test conditions and methods defined in AEC-Q200.

Please consult with Panasonic for the details of the product specification and specific evaluation test results, etc., and please review and approve Panasonic's product specification before ordering.

<Package markings>

Package markings include the product number, quantity, and country of origin.

In principle, the country of origin should be indicated in English.

Safety Precautions (Common precautions for Surface Mount Resistors)

The following are precautions for individual products. Please also refer to the common precautions for Fixed Resistors in this catalog.

1. Take measures against mechanical stress during and after mounting of Surface Mount Resistors (hereafter called the resistors) so as not to damage their electrodes and protective coatings. Be careful not to misplace the resistors on the land patterns. Otherwise, solder bridging may occur.
2. Keep the rated power and ambient temperature within the specified derating curve. Some circuit boards, wiring patterns, temperatures of heat generated by adjacent components, or ambient temperatures can become factors in the rise of the temperature of the resistors, regardless of the level of power applied. Therefore, check the conditions before use and optimize them so as not to damage the boards and peripheral components. Make sure to contact us before using the resistors under special conditions.
3. If a transient load (heavy load in a short time) like a pulse is expected to be applied, check and evaluate the operations of the resistors when installed in your products before use. Never exceed the rated power. Otherwise, the performance and/or reliability of the resistors may be impaired.
4. Transient voltage
If there is a possibility that the transient phenomenon (significantly high voltage applied in a short time) may occur or that a high voltage pulse may be applied, make sure to evaluate and check the characteristics of resistors mounted on your product rather than only depending on the calculated power limit or steady-state conditions.
5. If the resistors are to be used in high frequency circuits, carefully check the operation before use. Such circuits change the electrical characteristics of the resistors.
6. Before using halogen-based or other high-activity flux, check the possible effects of the flux residues on the performance and reliability of the resistors.
7. When soldering with a soldering iron, never touch the resistors' bodies with the tip of the soldering iron. When using a soldering iron with a high temperature tip, finish soldering as quickly as possible (within three seconds at 350 °C max.).
8. Mounting of the resistors with excessive or insufficient wetting amount of solder may affect the connection reliability or the performance of the resistors. Carefully check the effects and apply a proper amount of solder for use.
9. When the resistors' protective coatings are chipped, flawed, or removed, the characteristics of the resistors may be impaired. Take special care not to apply mechanical shock during automatic mounting or cause damage during handling of the boards with the resistors mounted.
10. Do not apply shock to the resistors or pinch them with a hard tool (e.g. pliers and tweezers). Otherwise, the resistors' protective coatings and bodies may be chipped, affecting their performance.
11. Avoid excessive bending of printed circuit boards in order to protect the resistors from abnormal stress.
12. Do not immerse the resistors in solvent for a long time. Before using solvent, carefully check the effects of immersion.
13. Do not apply excessive tension to the terminals.

X-ON Electronics

Largest Supplier of Electrical and Electronic Components

Click to view similar products for [Current Sense Resistors - SMD category](#):

Click to view products by [Panasonic manufacturer](#):

Other Similar products are found below :

[CRL0603-FW-R700ELF](#) [65709-330JE](#) [PF2512FKF7W0R007L](#) [PR2512FKF7W0R003L](#) [PR2512FKF7W0R005L](#) [PF2512FKF7W0R006L](#)
[PF2512FKF7W0R033L](#) [CD2015FC-0.10-1%](#) [PR2512FKF7W0R004L](#) [RC1005F124CS](#) [RL73K3AR56JTDF](#) [RL7520WT-R001-F](#)
[RL7520WT-R009-G](#) [RL7520WT-R020-F](#) [RLP73N1ER43JTD](#) [LRC-LR2512LF-01-R820J](#) [WR06X104JGLJ](#) [TL2BR01F](#) [65709-330](#) [SP1R12J](#)
[RL7520WT-R039-G](#) [PF1206FRF7W0R02L](#) [RL7520WT-R002-F](#) [RL7520WT-R047-F](#) [KRL1632E-C-R200-F-T5](#) [KRL1632E-C-R200-F-T1](#)
[Y14880R02000B9R](#) [RLP73M1ER051FTDF](#) [RLP73M2AR051FTDF](#) [RLP73M2AR075FTDF](#) [RLP73K2A1R0FTDF](#) [RLP73M1JR051FTDF](#)
[RLP73N1JR47FTDF](#) [SR731ERTTP5R10F](#) [SR731ERTTP100J](#) [SR731ERTTP6R80F](#) [SR731ERTTP4R70F](#) [SR731ERTTP2R20F](#)
[SR731ERTTP3R90F](#) [SR731ERTTP1R00F](#) [SR731ERTTP10R0F](#) [SR731ERTTP2R00F](#) [SR731ERTTP8R20F](#) [SR731ERTTP3R9J](#)
[SR731ERTTP8R2J](#) [SR731ERTTP2R0J](#) [SR731ERTTP4R7J](#) [SR731ERTTP9R1J](#) [SR731ERTTP1R0J](#) [SR731ERTTP2R2J](#)