

# ER-TF SERIES

Related Information

- General terms and conditions..... F-3
- Selection guide ..... P.1155~
- Glossary of terms..... P.1591
- General precautions ..... P.1595

No compressed air necessary



[panasonic.net/id/pidsx/global](http://panasonic.net/id/pidsx/global)

## Slim in shape, Wide in charge removal area, An evolutionary form in expression

### Safe design

A monitoring function stops discharge operation if any foreign material or object is detected in the discharge unit. This capability provides peace of mind when working with the unit since you can rest assured that the high-voltage circuit will stop if your finger approaches the unit.

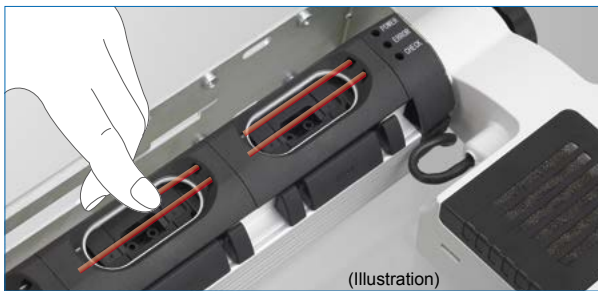

### Easy maintenance

Discharge units can be removed with a single touch, making it easy to clean them or replace them as they naturally wear down. Units can also be cleaned with a commercially available ultrasonic cleaner.

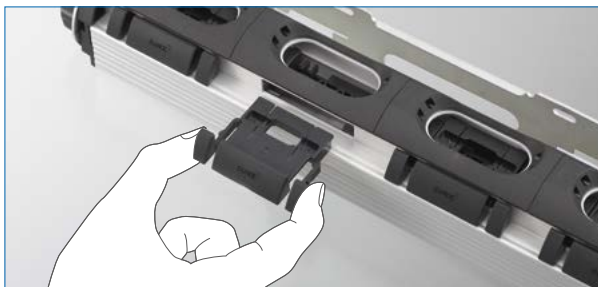

### Available quiet fan cover (optional)

An available fan cover reduces fan suction noise without reducing air volume.

### Flexible layout

Thanks to its space-saving design, the **ER-TF** series delivers a sufficiently large charge removal area while allowing you to make effective use of your workspace. It can be mounted on a shelf or pipe or placed directly on the working surface. The unit adapts flexibly to the local working environment.

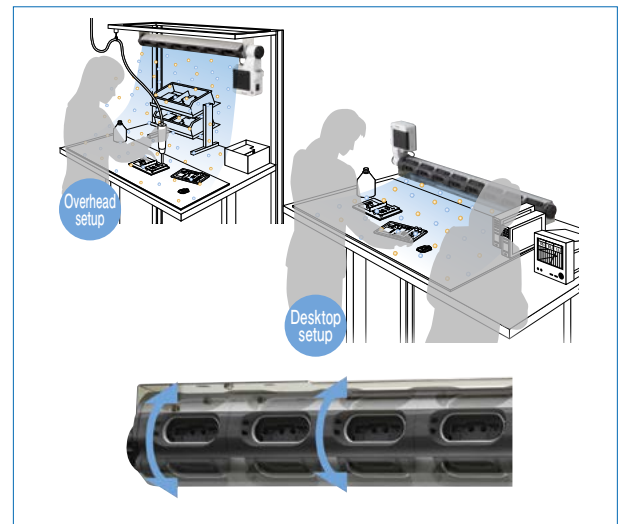

- FIBER SENSORS
- LASER SENSORS
- PHOTOELECTRIC SENSORS
- MICRO PHOTOELECTRIC SENSORS
- AREA SENSORS
- SAFETY LIGHT CURTAINS / SAFETY COMPONENTS
- PRESSURE / FLOW SENSORS
- INDUCTIVE PROXIMITY SENSORS
- PARTICULAR USE SENSORS
- SENSOR OPTIONS
- SIMPLE WIRE- SAVING UNITS
- WIRE- SAVING SYSTEMS
- MEASUREMENT SENSORS
- STATIC CONTROL DEVICES
- LASER MARKERS
- PLC
- HUMAN MACHINE INTERFACES
- ENERGY MANAGEMENT SOLUTIONS
- FA COMPONENTS
- MACHINE VISION SYSTEMS
- UV CURING SYSTEMS

- Selection Guide
- Static Removers
- Pulse Air-gun
- Cleaning Box
- Electrostatic Sensor

- ER-X
- ER-TF
- ER-VS02
- ER-VW
- ER-Q
- ER-F

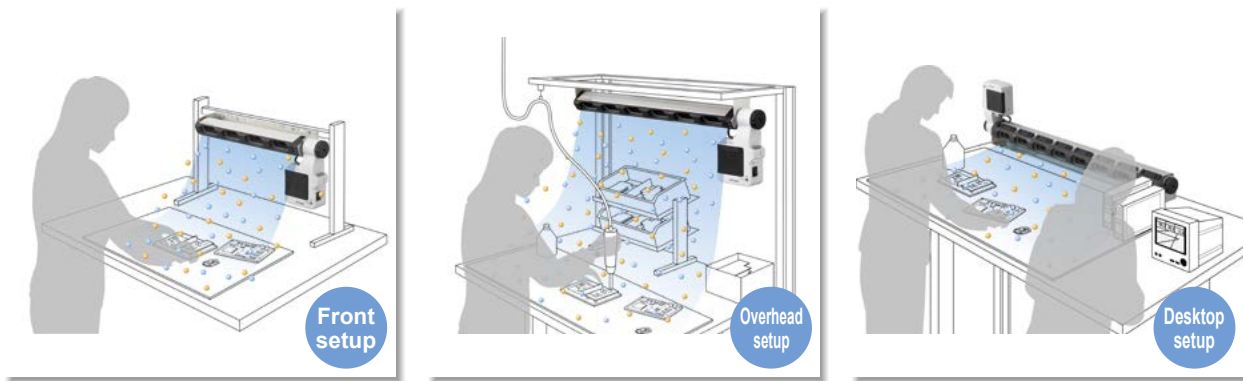
**APPLICATIONS****Indicators showing operation conditions**

This section will now explain the indicator lights that indicate such abnormalities as maintenance time of the discharge needle unit and the decrease in the amount of ventilation due to filter clogging.

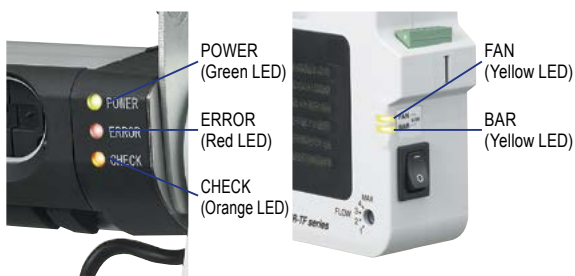
**ERROR indicator:**

Lights up when an intrusion of a foreign object into the discharger is detected by the entry detection function, or when an abnormal discharge, air intake constraint caused by clogged filter, or any other abnormality of the fan is detected.

**CHECK indicator:**

Lights up when it is time for maintenance of the discharge needle unit, or when a drop in the fan speed resulting from filter clogging is detected.

**FAN indicator:**

Lights up when a fan error or a fan check is detected.

**BAR indicator:**

Lights up when a discharger error or a discharger check is detected.

**Airflow adjustable in 4 levels**

Fan speed can be adjusted in 4 levels. By setting the fan speed to MAX, speedy static removal of wide area is possible.

**Easy filter cleaning**

The fan air intake filter can be easily taken out by sliding open the cover. This greatly reduces the man-hour in cleaning.

**Silent fan cover (option) is available.**

Without decreasing the airflow, it is possible to reduce noise during fan suction. You can easily attach the silent fan cover to the front of the main unit fan with a single step.

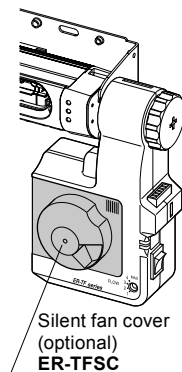

FIBER SENSORS

LASER SENSORS

PHOTOELECTRIC SENSORS

MICRO PHOTOELECTRIC SENSORS

AREA SENSORS

SAFETY LIGHT CURTAINS / SAFETY COMPONENTS

PRESSURE / FLOW SENSORS

INDUCTIVE PROXIMITY SENSORS

PARTICULAR USE SENSORS

SENSOR OPTIONS

SIMPLE WIRE-SAVING UNITS

WIRE-SAVING SYSTEMS

MEASUREMENT SENSORS

STATIC CONTROL DEVICES

LASER MARKERS

PLC

HUMAN MACHINE INTERFACES

ENERGY MANAGEMENT SOLUTIONS

FA COMPONENTS

MACHINE VISION SYSTEMS

UV CURING SYSTEMS

Selection Guide

Static Removers

Pulse Air-gun

Cleaning Box



Electrostatic Sensor

**ER-X****ER-TF****ER-VS02****ER-VW****ER-Q****ER-F**

FIBER SENSORS  
 LASER SENSORS  
 PHOTO-ELECTRIC SENSORS  
 MICRO PHOTO-ELECTRIC SENSORS  
 AREA SENSORS  
 SAFETY LIGHT CURTAINS / SAFETY COMPONENTS  
 PRESSURE / FLOW SENSORS  
 INDUCTIVE PROXIMITY SENSORS  
 PARTICULAR USE SENSORS  
 SENSOR OPTIONS  
 SIMPLE WIRE-SAVING UNITS  
 WIRE-SAVING SYSTEMS  
 MEASUREMENT SENSORS  
 STATIC CONTROL DEVICES  
 LASER MARKERS  
 PLC  
 HUMAN MACHINE INTERFACES  
 ENERGY MANAGEMENT SOLUTIONS  
 FA COMPONENTS  
 MACHINE VISION SYSTEMS  
 UV CURING SYSTEMS  
 Selection Guide  
 Static Removers  
 Pulse Air-gun  
 Cleaning Box  
 Electrostatic Sensor

## ORDER GUIDE

### Ionizer main unit

Type	Appearance	Charge removal time (±1,000 V → ±100 V)	Ion balance	Model No.
Wide-area fan type		1 sec. approx. (Note 1)	±10 V or less (Note 2)	<b>ER-TF04-EX</b>
				<b>ER-TF06-EX</b>
				<b>ER-TF08-EX</b>

- Notes: 1) Typical value at 200 mm **7.874 in** from directly in front of air outlet at the unit center at maximum fan speed.  
 2) Typical value at 300 mm **11.811 in** from directly in front of air outlet at the unit center at maximum fan speed.  
 3) Please prepare an AC cable separately as it is needed.

The following cables are available as optionals:

**CN-ACCN-C2**: AC cable (conforming to CCC), **CN-ACKR-C2**: AC cable (conforming to KTL)



Connector configuration (IEC 60320 C7)

## OPTIONS

Designation	Model No.	Description
AC cable	<b>CN-ACCN-C2</b>	AC cable (conforming to CCC), Length: 2 m <b>6.562 ft</b>
	<b>CN-ACKR-C2</b>	AC cable (conforming to KTL), Length: 2 m <b>6.562 ft</b>
Mounting unit	<b>ER-TF06MS1</b>	Mounting unit for <b>ER-TF06-EX</b> . Allows easy attachment or detachment of the main unit.
Air filter	<b>ER-TFF×10</b>	Air filter for fan air intake part (10 pcs. per set)
Discharge needle unit	<b>ER-TFANT</b>	Unit with tungsten needles (1 pc.)
Silent fan cover	<b>ER-TFSC</b>	To be mounted on the front part of the fan unit as a cover to reduce the fan blowing sound.

### Mounting unit

•ER-TF06MS1

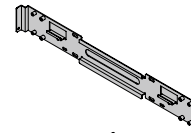

### Air filter

•ER-TFF×10



### Discharge needle unit

•ER-TFANT

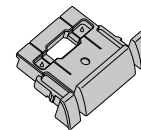

### Silent fan cover

•ER-TFSC

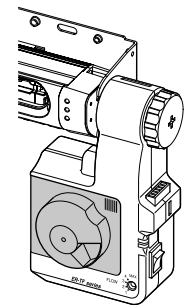

**ER-X**  
**ER-TF**  
**ER-VS02**  
**ER-VW**  
**ER-Q**  
**ER-F**

**SPECIFICATIONS**

Item	Type	Wide-area fan type		
	Model No.	ER-TF04-EX	ER-TF06-EX	ER-TF08-EX
CE marking directive compliance	EMC Directive, RoHS Directive			
Charge removal time ( $\pm 1,000$ V $\rightarrow$ $\pm 100$ V)	1 sec. approx. (Note 2)			
Ion balance	$\pm 10$ V or less (Note 3)			
Ozone generation	0.02 ppm or less (Note 3)			
Power supply voltage	Accessory AC adapter input: 100-240 V AC $\pm 10$ % 50/60 Hz (Note 4) (Output: 24 V DC)			
Power consumption	80 VA or less (at 100 V: 70 VA or less)			
Discharge method	Steady-state DC			
Discharge output voltage	$\pm 6,000$ V approx.			
Error output	NPN open-collector transistor • Maximum sink current: 50 mA • Applied voltage: 30 V DC or less (between output and 0 V) • Residual voltage: 1 V or less (at 50 mA sink current)			
	Output operation	OFF if abnormal discharge, object inserted into discharge window or fan problem detected; normally ON		
	Short-circuit protection	Incorporated		
Indicators	Bar	POWER	Green LED (Lights up when the power is ON)	
		ERROR	Red LED (Lights up when discharge part error or fan error is detected)	
		CHECK	Orange LED (Lights up when discharge part check or fan check is detected)	
	Fan	Discharge part status	Yellow LED (Lights up when discharge part error or discharge part check is detected)	
		Fan status	Yellow LED (Lights up when fan error or fan check is detected)	
Ambient temperature	0 to +50 °C <b>+32 to +122 °F</b> (No dew condensation), AC adapter: 0 to +40 °C <b>+32 to +104 °F</b>			
Ambient humidity	35 to 65 % RH (No dew condensation allowed)			
Material	Bar unit enclosure: ABS, Fan unit enclosure: ABS, Discharge needles: Tungsten, Mounting bracket: Cold rolled carbon steel (SPCC)			
Weight	Net weight: 1.0 kg approx.	Net weight: 1.2 kg approx.	Net weight: 1.4 kg approx.	
Accessories	AC adapter (Note 3), F.G. connection cable: 1 pc., Spare replacement filters: 5 pcs., Three-pronged outlet with ground pin: 1 pc., Blindfold seals: 2 sheets			

Notes: 1) Where measurement conditions have not been specified precisely, the conditions used were an ambient temperature of +20 °C **+68 °F**.

2) Typical value at 200 mm **7.874 in** from directly in front of air outlet at the unit center at maximum fan speed.

3) Typical value at 300 mm **11.811 in** from directly in front of air outlet at the unit center at maximum fan speed.

4) Please prepare an AC cable separately as it is needed.

The following cables are available as optionals:

**CN-ACCN-C2**: AC cable (conforming to CCC), **CN-ACKR-C2**: AC cable (conforming to KTL)

FIBER  
SENSORSLASER  
SENSORSPHOTO-  
ELECTRIC  
SENSORSMICRO  
PHOTO-  
ELECTRIC  
SENSORSAREA  
SENSORSSAFETY LIGHT  
CURTAINS/  
SAFETY  
COMPONENTSPRESSURE /  
FLOW  
SENSORSINDUCTIVE  
PROXIMITY  
SENSORSPARTICULAR  
USE  
SENSORSSENSOR  
OPTIONSSIMPLE  
WIRE-SAVING  
UNITSWIRE-SAVING  
SYSTEMSMEASURE-  
MENT  
SENSORSSTATIC  
CONTROL  
DEVICESLASER  
MARKERS

PLC

HUMAN  
MACHINE  
INTERFACESENERGY  
MANAGEMENT  
SOLUTIONSFA  
COMPONENTSMACHINE  
VISION  
SYSTEMSUV  
CURING  
SYSTEMSSelection  
GuideStatic  
RemoversPulse  
Air-gunCleaning  
BoxElectrostatic  
Sensor**ER-X****ER-TF****ER-VS02****ER-VW****ER-Q****ER-F**

## I/O CIRCUIT AND WIRING DIAGRAMS

### I/O circuit diagram

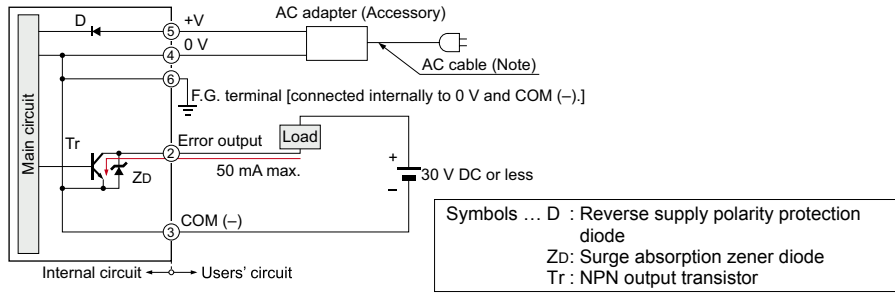

Note: Please prepare an AC cable separately as it is needed.  
The following cables are available as optionals:  
**CN-ACCN-C2**: AC cable (conforming to CCC)  
**CN-ACKR-C2**: AC cable (conforming to KTL)

### Terminal position

Terminal No.	Terminal name
①	N.C. (no connection)
②	Error output
③	COM (-)
④	0 V
⑤	+V
⑥	F.G.

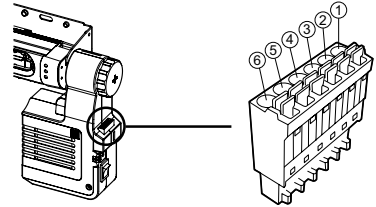

## CHARGE REMOVAL CHARACTERISTICS (TYPICAL)

Measured using a 150 × 150 mm 5.906 × 5.906 in CPM (charge plate monitor). (At center of CPM)

### ER-TF04-EX

#### Charge removal time

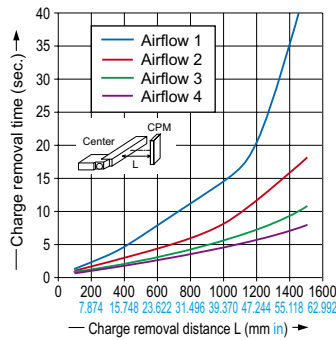

#### Correlation between charge removal distance and ion balance

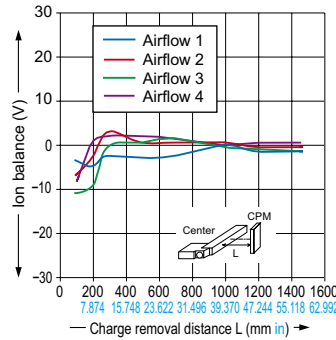

#### Charge removal field (Horizontal direction)

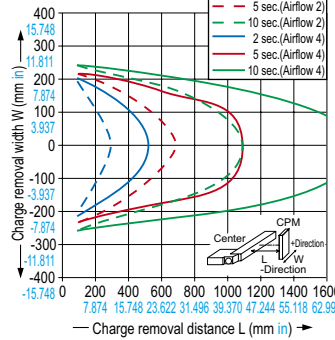

#### Ion balance (Horizontal direction) [Airflow 4]

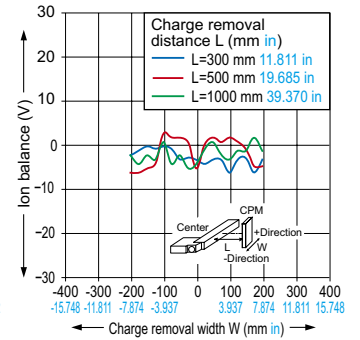

### ER-TF06-EX

#### Charge removal time

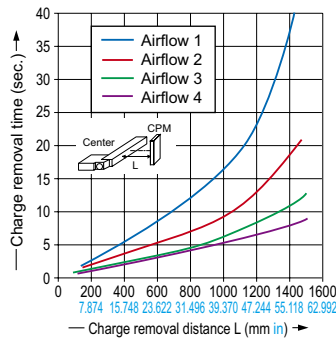

#### Correlation between charge removal distance and ion balance

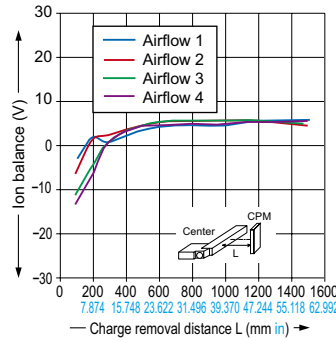

#### Charge removal field (Horizontal direction)

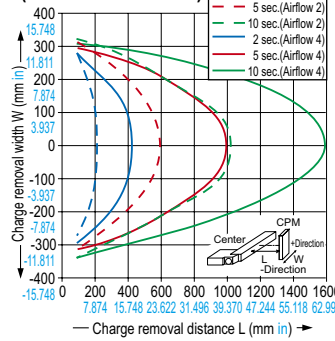

#### Ion balance (Horizontal direction) [Airflow 4]

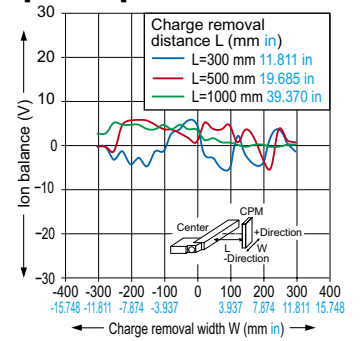

### ER-TF08-EX

#### Charge removal time

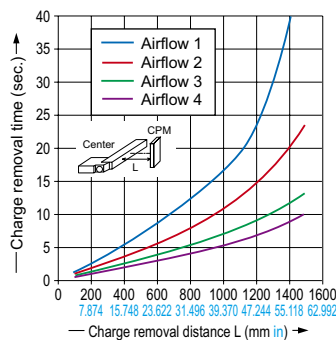

#### Correlation between charge removal distance and ion balance

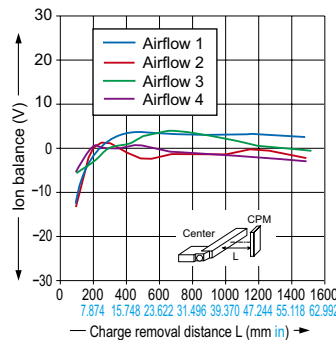

#### Charge removal field (Horizontal direction)

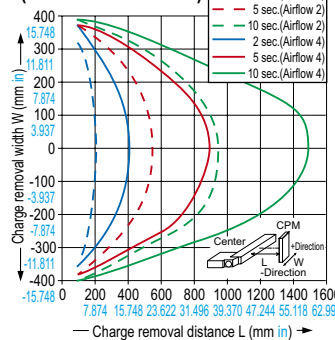

#### Ion balance (Horizontal direction) [Airflow 4]

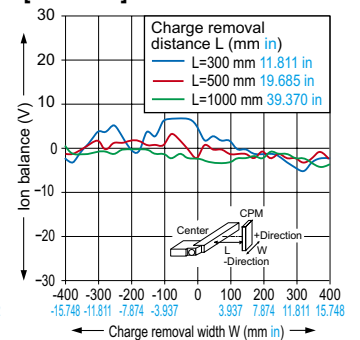

FIBER SENSORS  
LASER SENSORS  
PHOTO-ELECTRIC SENSORS  
MICRO PHOTO-ELECTRIC SENSORS  
AREA SENSORS  
SAFETY LIGHT CURTAINS / SAFETY COMPONENTS  
PRESSURE / FLOW SENSORS  
INDUCTIVE PROXIMITY SENSORS  
PARTICULAR USE SENSORS  
SENSOR OPTIONS  
SIMPLE WIRE-SAVING UNITS  
WIRE-SAVING SYSTEMS  
MEASUREMENT SENSORS  
STATIC CONTROL DEVICES  
LASER MARKERS  
PLC  
HUMAN MACHINE INTERFACES  
ENERGY MANAGEMENT SOLUTIONS  
FA COMPONENTS  
MACHINE VISION SYSTEMS  
UV CURING SYSTEMS  
Selection Guide  
Static Removers  
Pulse Air-gun  
Cleaning Box  
Electrostatic Sensor  
ER-X  
ER-TF  
ER-VS02  
ER-VW  
ER-Q  
ER-F



**PRECAUTIONS FOR PROPER USE**

Refer to p.1595 for general precautions.



- This product is to remove static electricity for industrial use. Never use this product for medical equipment etc. relating to maintenance / supervision of human life or body, for prevention of accidents which damage a human life or properties, or for safety maintenance.
- Do not use this product near or around surroundings containing any dangerous materials, such as combustible material and flammable material.
- This product emits ozone. In order for this product to be used in an airtight room, be sure to keep the room ventilated.
- Do not place any objects that may obstruct the inflow of air within 10 mm **0.394 in** of the front of the fan air intake part. Doing so may cause accident or product malfunction.
- Be sure to ground the main body of this product via ground terminal to ensure electrical shock prevention and reliable charge removal.
- Since the charge needle is applied with high voltage, never touch the discharge needle, or an electric shock may result.
- Since the tip of the discharge needle is sharp, take sufficient care in handling the discharge needle, or injuries may result.

**Mounting**

- Do not place any objects or any other charge removal equipment within 100 mm **3.937 in** of the ionized air outlet front (refer to the illustration below), as they may affect operation and performance of the ionizer.

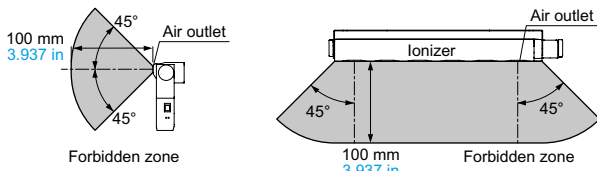
**Maintenance**

- Always be sure to turn off the power before carrying out any care and maintenance of the product.
- The tip of the discharge needle is sharp, so be careful not to touch it while cleaning.
- When the product is used for long periods of time, dust and other foreign particles may accumulate on the discharge needle, the area around it, and on the fan filter. Clean regularly (discharge needle: about once a week, air filter: about once every two months), otherwise their charge removal performance will drop and operating problems or accidents may occur.
- The discharge needle is a consumable part. If the charge removal performance is not restored after cleaning the discharge needle, the discharge needle unit should be replaced. All of the discharge needle units should be replaced at the same time.

**DIMENSIONS (Unit: mm in)**

The CAD data can be downloaded from our website.

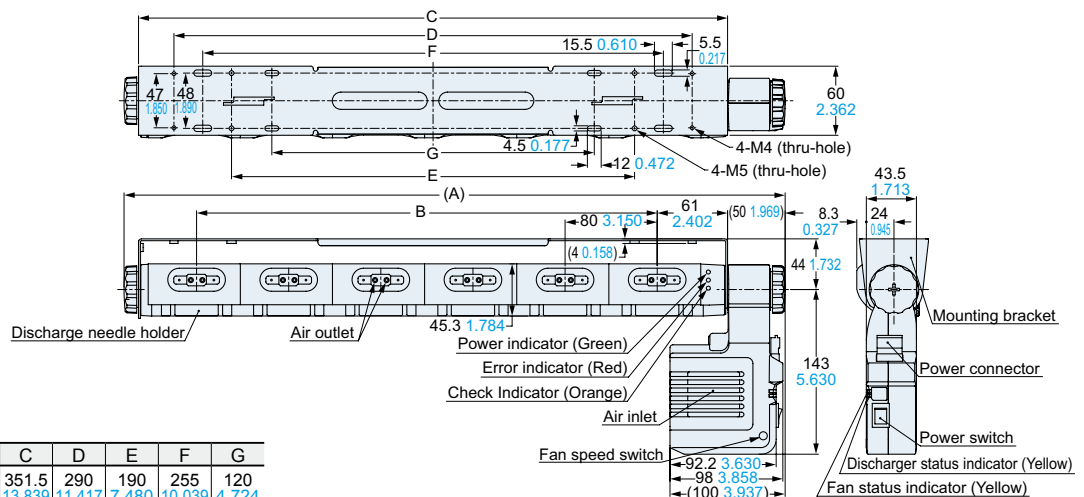
**ER-TF□-EX****ionizer**

Model No.	A	B	C	D	E	F	G
<b>ER-TF04-EX</b>	414 16.299	240 9.449	351.5 13.839	290 11.417	190 7.480	255 10.039	120 4.724
<b>ER-TF06-EX</b>	574 22.598	400 15.748	511.5 20.138	450 17.717	350 13.780	400 15.748	280 11.024
<b>ER-TF08-EX</b>	734 28.898	560 22.047	671.5 26.437	610 24.016	510 20.079	560 22.047	440 17.323

FIBER  
SENSORSLASER  
SENSORSPHOTO-  
ELECTRIC  
SENSORSMICRO  
PHOTO-  
ELECTRIC  
SENSORSAREA  
SENSORSSAFETY LIGHT  
CURTAINS/  
SAFETY  
COMPONENTSPRESSURE /  
FLOW  
SENSORSINDUCTIVE  
PROXIMITY  
SENSORSPARTICULAR  
USE  
SENSORSSENSOR  
OPTIONSSIMPLE  
WIRE-SAVING  
UNITSWIRE-SAVING  
SYSTEMSMEASURE-  
MENT  
SENSORS**STATIC  
CONTROL  
DEVICES**LASER  
MARKERS

PLC

HUMAN  
MACHINE  
INTERFACESENERGY  
MANAGEMENT  
SOLUTIONSFA  
COMPONENTSMACHINE  
VISION  
SYSTEMSUV  
CURING  
SYSTEMSSelection  
GuideStatic  
RemoversPulse  
Air-gunCleaning  
BoxElectrostatic  
Sensor**ER-X****ER-TF****ER-VS02****ER-VW****ER-Q****ER-F**

## X-ON Electronics

Largest Supplier of Electrical and Electronic Components

*Click to view similar products for [panasonic](#) manufacturer:*

Other Similar products are found below :

[ECE-A1HKAR47](#) [ELC-09D151F](#) [HC2-H-DC48V-F](#) [HL2-HP-AC120V-F](#) [HL2-H-DC12V-F](#) [HL2-HP-DC12V-F](#) [HL2-HP-DC6V-F](#) [HL2-HP-DC24V-F](#) [HL2-H-DC110V-F](#) [HC4-H-DC24V](#) [HL2-HTM-DC24V-F](#) [HL2-HTM-AC24V-F](#) [HC4-H-AC24V](#) [HC4-H-AC120V](#) [HC4-H-DC12V](#) [AZH2031](#) [RP-SDMF64DA1](#) [EVM-F6SA00B55](#) [RP-SMLE08DA1](#) [ERZ-V20R391](#) [ELL-ATV681M](#) [ERZ-V05V680CB](#) [LT4H-DC24V](#) [LT4HL8-AC24V](#) [LT4HW-AC24V](#) [LT4HWT8-AC240V](#) [LT4HWT-AC240VS](#) [CY-122A-P](#) [ETQ-P5M470YFM](#) [EVAL\\_PAN1555](#) [EVQ-PAE04M](#) [EX-14B](#) [EX-22B-PN](#) [EX-31A-C5](#) [EXB-24N121JX](#) [EX-F72-PN](#) [EX-L211](#) [EYG-A121803V](#) [FCR-M50-AC208V](#) [FC-SFBH-20](#) [FC-SFBH-24](#) [FD-F8Y](#) [MHMA102A1C](#) [MHMD022S1S](#) [MHMD041S1S](#) [MHMD042G1T](#) [MHMD082G1T](#) [FD-S9](#) [FP0-LDR](#) [FP2-AD8X](#)