

ER-VS02

Related Information

- General terms and conditions..... F-3
- Selection guide P.1155~
- Glossary of terms..... P.1591
- General precautions P.1595



panasonic.net/id/pidsx/global

No. 1* in ability to accommodate a range of applications thanks to outstanding ion balance, robust dust resistance, and an extensive nozzle selection * In-company survey

Optimized discharge needle tip shape for even more stable ion-producing power

The discharge needle tip's spherical shape enables more stable ion production while making it less likely that the shape of the tip will change over time as a result of electrical discharge.

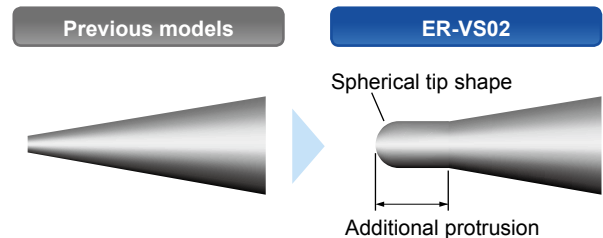

Improved maintenance cycle

Stable ion-producing performance contributes to a longer maintenance cycle, which has been improved to one month or longer* in the **ER-VS**.

*When used in an operating environment that complies with Panasonic Industrial Device SUNX requirements

Selection of nozzles for different applications

In addition to eight standard nozzle types, including shower and tube nozzles, we offers a range of differently shaped nozzles (including made-to-order models).

Produces excellent ion balance

The adoption of high-frequency AC method allows extremely stable ion balance to be achieved. Because the ion balance is not affected by the pressure of air supplied or by the setup distance, no troublesome adjustments are required after setup.

Charge removal time (typical)

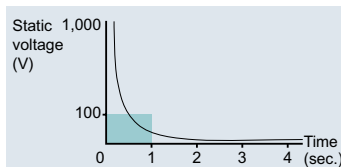

Ion balance comparison

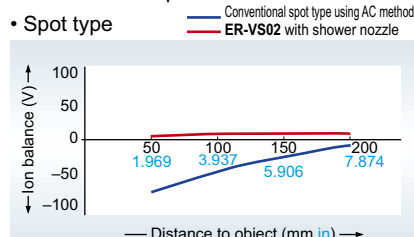

* Comparison test carried out by Panasonic Industrial devices SUNX

Bar type

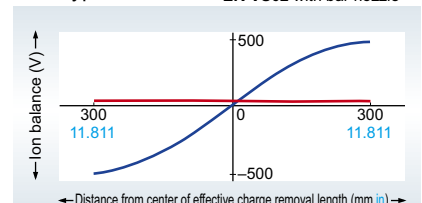

* Comparison test carried out by Panasonic Industrial devices SUNX

- FIBER SENSORS
- LASER SENSORS
- PHOTOELECTRIC SENSORS
- MICRO PHOTOELECTRIC SENSORS
- AREA SENSORS
- SAFETY LIGHT CURTAINS / SAFETY COMPONENTS
- PRESSURE / FLOW SENSORS
- INDUCTIVE PROXIMITY SENSORS
- PARTICULAR USE SENSORS
- SENSOR OPTIONS
- SIMPLE WIRE-SAVING UNITS
- WIRE-SAVING SYSTEMS
- MEASUREMENT SENSORS
- STATIC CONTROL DEVICES
- LASER MARKERS
- PLC
- HUMAN MACHINE INTERFACES
- ENERGY MANAGEMENT SOLUTIONS
- FA COMPONENTS
- MACHINE VISION SYSTEMS
- UV CURING SYSTEMS

- Selection Guide
- Static Removers
- Pulse Air-gun
- Cleaning Box
- Electrostatic Sensor

- ER-X
- ER-TF
- ER-VS02**
- ER-VW
- ER-Q
- ER-F

APPLICATIONS

Charge removal and dust removal of relay and switch contacts

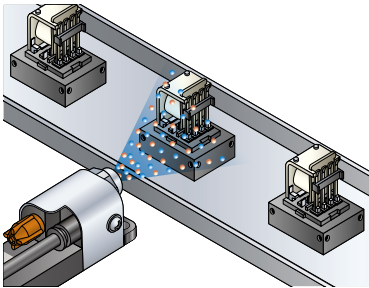

Pinpoint charge removal of electronic components

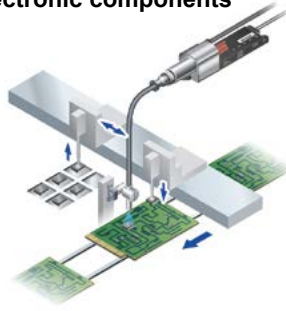

Removal of dust from connectors and switches

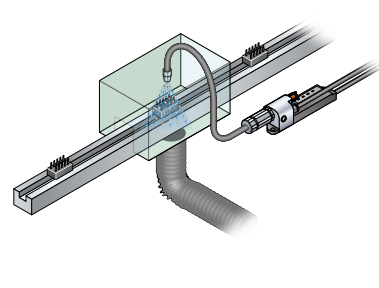

Ultra-compact design accurately removes charges of objects even from narrow spaces

The main unit is merely 109 × 27 × 28 mm 4.291 × 1.063 × 1.102 in, so it can easily be combined with other devices and also be installed as an add-on. Furthermore, the high-voltage power supply is built-in, so no extra space is required except for the ionizer itself.

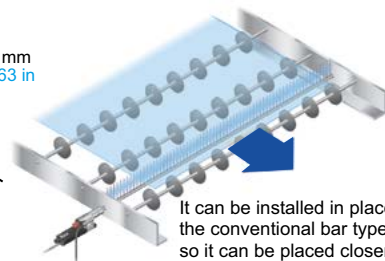

It can be installed in places where the conventional bar type cannot, so it can be placed closer to the object for more accurate charge removal.

BASIC PERFORMANCE / MAINTENANCE

Completely safe design and easy maintenance

Easy discharge needle maintenance

The discharge needle can be removed from the rear of the main unit, so there is no need to remove the nozzle when replacing the needle. Maintenance is easy even when the ion air outlet is located close to the object.



Low power consumption and low-voltage wiring

The power supply voltage is 24 V DC, and the power consumed is only 70 mA or less. In addition, safety is enhanced because no high-voltage cables are required.

Discharge needle is covered by the nozzle

The discharge needle does not protrude from the main unit, so it cannot be touched by accident. Furthermore, no leaks can occur when it is brought close to metallic objects.

Safe design

A "checking function" and an "abnormal discharge monitoring function" are provided to notify the operator when it is time to clean or replace the discharge needle and to prevent discharge problems from occurring. Each function has an LED display to use for checking. The output from each function can also be used to externally monitor the status of the ionizer during operation.

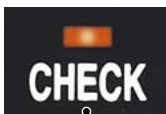

Lights up when the discharge needle is worn or dirty
(Orange LED)
[Checking function]
When lit, the discharge needle may be worn or dirty.

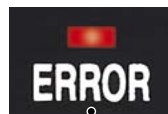

Lights up when abnormal discharge is detected
(Red LED)
[Abnormal discharge monitoring function]
When lit, an abnormal discharge has been detected, e.g. due to a foreign substance, and discharge halted in order to maintain safety.



FIBER SENSORS

LASER SENSORS

PHOTOELECTRIC SENSORS

MICRO PHOTOELECTRIC SENSORS

AREA SENSORS

SAFETY LIGHT CURTAINS / SAFETY COMPONENTS

PRESSURE / FLOW SENSORS

INDUCTIVE PROXIMITY SENSORS

PARTICULAR USE SENSORS

SENSOR OPTIONS

SIMPLE WIRE-SAVING UNITS

WIRE-SAVING SYSTEMS

MEASUREMENT SENSORS

STATIC CONTROL DEVICES

LASER MARKERS

PLC

HUMAN MACHINE INTERFACES

ENERGY MANAGEMENT SOLUTIONS

FA COMPONENTS

MACHINE VISION SYSTEMS

UV CURING SYSTEMS

Selection Guide

Static Removers

Pulse Air-gun

Cleaning Box

Electrostatic Sensor

ER-X

ER-TF

ER-VS02

ER-VW

ER-Q

ER-F

FIBER SENSORS
LASER SENSORS
PHOTO-ELECTRIC SENSORS
MICRO PHOTO-ELECTRIC SENSORS
AREA SENSORS
SAFETY LIGHT CURTAINS / SAFETY COMPONENTS
PRESSURE / FLOW SENSORS
INDUCTIVE PROXIMITY SENSORS
PARTICULAR USE SENSORS
SENSOR OPTIONS
SIMPLE WIRE-SAVING UNITS
WIRE-SAVING SYSTEMS
MEASURE-MENT SENSORS
STATIC CONTROL DEVICES
LASER MARKERS
PLC
HUMAN MACHINE INTERFACES
ENERGY MANAGEMENT SOLUTIONS
FA COMPONENTS
MACHINE VISION SYSTEMS
UV CURING SYSTEMS
Selection Guide
Static Removers
Pulse Air-gun
Cleaning Box
Electrostatic Sensor
ER-X
ER-TF
ER-VS02
ER-VW
ER-Q
ER-F

FUNCTIONS

High performance with no controller needed

A full range of functions have been provided with full consideration given to ease of use in the workplace. No separate controller is needed.

Discharge halt input

A signal from an external device can be used to turn discharge ON and OFF. Sensors can be used to detect the objects so that the ion air is generated only when required.

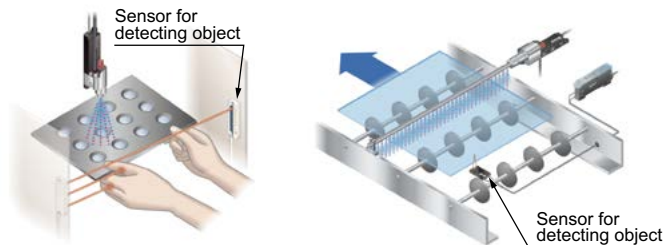

Discharge indicator

The discharge ON/OFF status can be checked using an LED display. This lets you avoid problems such as when the power is on but no discharge is occurring.

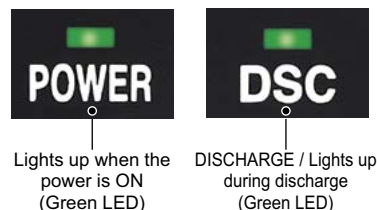

ORDER GUIDE

Ionizer main unit Nozzle and cable with connector are not supplied with the ionizer main unit. Please order them separately.

Type	Appearance	Charge removal time (±1,000 V → ±100 V)	Ion balance	Model No.
Spot type	 * The photograph shows the unit fitted with a shower nozzle.	1 sec. or less (Note)	±10 V or less (Note)	ER-VS02

Note: A typical sample applied with a supply voltage of 24 V, a distance of 100 mm 3.937 in from the front surface of the air flow outlet and a pressure of 0.25 MPa while the shower nozzle is in use.
(Measured on a sample left in the atmosphere at a relative humidity of 65 % RH or less for 24 hours or more.)

Nozzles Nozzle is not supplied with the ionizer main unit. Please order it separately.

Type	Appearance	Model No.	Description
Shower nozzle	 Effective charge removal length	ER-VAS	Air dispersal type
Straight bar nozzle (Note)	 Effective charge removal length	ER-VAB020	Effective charge removal length 200 mm 7.874 in
		ER-VAB032	Effective charge removal length 320 mm 12.598 in
		ER-VAB065	Effective charge removal length 650 mm 25.591 in

Note: In addition to the effective charge removal lengths listed above, we can supply models with an effective charge removal length ranging from 100 to 640 mm 3.937 to 25.197 in in 10 mm 0.394 in increments on a special-order basis.
Model number: **ER-VAB□N** (for an effective charge removal length of 180 mm 7.087 in: **ER-VAB018N**)
For details, please contact our sales office.

ORDER GUIDE**Nozzles / Tubes** Nozzle is not supplied with the ionizer main unit. Please order it separately.

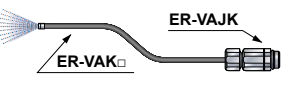
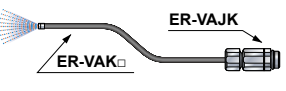
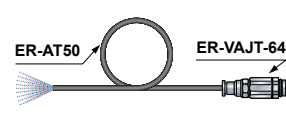
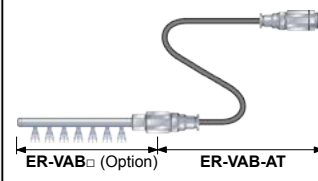
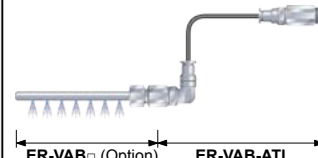
Type	Appearance	Model No.	Description
Joint nozzle		ER-VAJK	Joint nozzle for ionizer main unit and shape-preserving tube
Shape-preserving tube (Note)		ER-VAK10	Tube length 112 mm 4.409 in
		ER-VAK30	Tube length 312 mm 12.283 in
		ER-VAK50	Tube length 512 mm 20.157 in
			Bends easily and holds its bent shape so the tube does not need to be secured (Tube diameter: ϕ 10 mm ϕ 0.394 in Minimum bending radius: R40 mm R1.575 in)
Joint nozzle		ER-VAJT-64	Joint nozzle for ionizer main unit and conductive tube
Conductive tube		ER-AT50	Tube length 500 mm 19.685 in
			This flexible conductive tube is suitable for a variety of applications since it can be cut to the desired length. (Tube diameter: ϕ 6 mm ϕ 0.236 in Minimum bending radius: R15 mm R0.591 in)
Tube joint set		ER-VAB-AT	Tube length 500 mm 19.685 in
			This set includes flexible, free-cut conductive tube and a joint nozzle. (Tube diameter: ϕ 8 mm ϕ 0.315 in Minimum bending radius: R25 mm R0.984 in)
		ER-VAB-ATL	Tube length 500 mm 19.685 in
			Compatible nozzles: straight nozzles (Effective charge removal length 320 mm 12.598 in or less)

Note: We can also supply shape-preserving tubes at lengths shorter than the tube lengths noted above on a special-order basis. For details, please contact our office.

Cables with connector Cable with connector is not supplied with the ionizer main unit. Please order it separately.

Appearance	Model No.	Description
	ER-VCCJ2	Length: 2 m 6.562 ft , Net weight: 52 g approx.
	ER-VCCJ5	Length: 5 m 16.404 ft , Net weight: 120 g approx.
	ER-VCCJ9	Length: 9 m 29.528 ft , Net weight: 240 g approx.
		0.15mm ² 8-core cabtyre cable with connector Cable outer diameter: ϕ 4.2 mm ϕ0.165 in

OPTIONS

Type	Model No.	Description
Conductive tube holder	ER-ATH	Used to secure conductive tubes
Mini line filter	ER-AF10	Processed air volume 40 ℓ /min. (ANR) Removes solid particles such as dirt and dust from air supply • Collected particle dia.: 0.1 μ m 0.004 mil • Collection efficiency: 99.9 %
	ER-AF20	Processed air volume 80 ℓ /min. (ANR)
AC adapter	ER-VAPS1	• IN: 100-240 V AC, 50/60 Hz, 40 VA • OUT: 24 V DC, 750 mA • Ambient temperature: 0 to +40 °C +32 to +104 °F
Discharge needle unit	ER-VANT2	Unit with tungsten needle (1 set)

Conductive tube holder

- **ER-ATH**

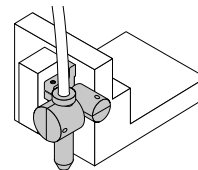
**Mini line filter**

- **ER-AF10**
- **ER-AF20**



* The photograph shows **ER-AF10**

AC adapter

- **ER-VAPS1**

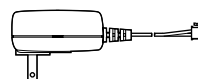
**Discharge needle unit**

- **ER-VANT2**

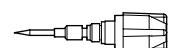

FIBER SENSORS

LASER SENSORS

PHOTO-ELECTRIC SENSORS

MICRO PHOTO-ELECTRIC SENSORS

AREA SENSORS

SAFETY LIGHT CURTAINS / SAFETY COMPONENTS

PRESSURE / FLOW SENSORS

INDUCTIVE PROXIMITY SENSORS

PARTICULAR USE SENSORS

SENSOR OPTIONS

SIMPLE WIRE-SAVING UNITS

WIRE-SAVING SYSTEMS

MEASUREMENT SENSORS

STATIC CONTROL DEVICES

LASER MARKERS

PLC

HUMAN MACHINE INTERFACES

ENERGY MANAGEMENT SOLUTIONS

FA COMPONENTS

MACHINE VISION SYSTEMS

UV CURING SYSTEMS

Selection Guide

Static Removers

Pulse Air-gun

Cleaning Box

Electrostatic Sensor

ER-X**ER-TF****ER-VS02****ER-VW****ER-Q****ER-F**

SPECIFICATIONS

Main unit

Item	Type Model No.	Spot type ER-VS02
CE marking directive compliance		EMC Directive, RoHS Directive
Charge removal time ($\pm 1,000$ V \rightarrow ± 100 V)		1 sec. or less (Note 2)
Ion balance		± 10 V or less (Note 2)
Ozone generation		0.03 ppm or less (Note 3)
Applicable fluid		Air (dried clean air) (Note 4)
Supplied air flow		500 ℓ /min. (ANR) or less (Note 5)
Air pressure range		0.05 to 0.7 MPa (Note 5)
Supply voltage		24 V DC ± 10 %
Current consumption		70 mA or less
Discharge method		High frequency AC method
Discharge output voltage		2,000 V approx.
Check output (CHECK)		NPN open-collector transistor <ul style="list-style-type: none"> • Maximum sink current: 50 mA • Applied voltage: 30 V DC or less (between check output and 0 V) • Residual voltage: 1 V or less (at 50 mA sink current)
Output operation		ON when a dirt or worn etc. of the discharge needle is detected for 1.5 sec. or more continuously, OFF when operation is normal (Note 6)
Short-circuit protection		Incorporated
Error output (ERROR)		NPN open-collector transistor <ul style="list-style-type: none"> • Maximum sink current: 50 mA • Applied voltage: 30 V DC or less (between error output and 0 V) • Residual voltage: 1 V or less (at 50 mA sink current)
Output operation		OFF when abnormal discharge is detected, ON when operation is normal
Short-circuit protection		Incorporated
Discharge halt input (DSC OFF) (Note 7)		Short-circuit to 0 V: Discharge halt, Open: Discharge allowed (operation start)
Reset input		When abnormal discharge is detected, discharge is halted due to an error. Reset the discharge halt by briefly shorting the power supply's 0 V line.
Indicators	Power (POWER)	Green LED (lights up when the power is ON)
	Discharge (DSC) (Note 7)	Green LED (lights up when discharging)
	Check (CHECK)	Orange LED (lights up when the discharge needle is worn or dirty, etc.) (Note 6)
	Error (ERROR)	Red LED (lights up when abnormal discharge is detected)
Environmental resistance	Ambient temperature	0 to +55 °C +32 to +131 °F (No dew condensation allowed)
	Ambient humidity	35 to 65 % RH
	Vibration resistance	10 to 150 Hz frequency, 0.75 mm 0.030 in double amplitude in X, Y and Z directions for two hours each
Cable		Cable with a connector, 0.5 m 1.640 ft long
Material		Enclosure: PPS, Cover: Stainless steel, Discharge needle: Tungsten
Weight		Net weight: 120 g approx.
Accessory		Connector for wiring: 1 set [Manufactured by Molex: Housing (5557-08R), Terminal (5556TL)]

Notes: 1) Where measurement conditions have not been specified precisely, the conditions used were an ambient temperature of +20 °C +68 °F.

2) A typical sample applied with a supply voltage of 24 V, a distance of 100 mm 3.937 in from the front surface of the air flow outlet and a pressure of 0.25 MPa while the shower nozzle is in use. (Measured on a sample left in the atmosphere at a relative humidity of 65 % RH or less for 24 hours or more.)

3) A typical sample applied with a power voltage of 24 V, a distance of 300 mm 11.811 in from the front surface of the air flow outlet and a pressure of 0.25 MPa while the shower nozzle is in use.

4) Dried clean air is the air passing through air dryer (dew point -20 °C -4 °F approx.) and air filter (mesh size 0.01 μ m 0.0004 mil approx.)

5) The applicable pressure range depends on the nozzle to be used.

6) When confirming the check output, carry out discharge for 2 sec. or more.

7) "DSC" is an abbreviated name of "DISCHARGE".

FIBER
SENSORSLASER
SENSORSPHOTO-
ELECTRIC
SENSORSMICRO
PHOTO-
ELECTRIC
SENSORSAREA
SENSORSSAFETY LIGHT
CURTAINS/
SAFETY
COMPONENTSPRESSURE /
FLOW
SENSORSINDUCTIVE
PROXIMITY
SENSORSPARTICULAR
USE
SENSORSSENSOR
OPTIONSSIMPLE
WIRE-SAVING
UNITSWIRE-SAVING
SYSTEMSMEASURE-
MENT
SENSORSSTATIC
CONTROL
DEVICESLASER
MARKERS

PLC

HUMAN
MACHINE
INTERFACESENERGY
MANAGEMENT
SOLUTIONSFA
COMPONENTSMACHINE
VISION
SYSTEMSUV
CURING
SYSTEMSSelection
GuideStatic
RemoversPulse
Air-gunCleaning
BoxElectrostatic
Sensor

ER-X

ER-TF

ER-VS02

ER-VW

ER-Q

ER-F

SPECIFICATIONS

Nozzles/Tubes

Type	Shower nozzle	Straight bar nozzle 200 mm 7.874 in	Straight bar nozzle 320 mm 12.598 in	Straight bar nozzle 650 mm 25.591 in
Item	ER-VAS	ER-VAB020	ER-VAB032	ER-VAB065
Supplied air pressure range	0.05 to 0.4 MPa			
Charge removal range	—	200 mm 7.874 in	320 mm 12.598 in	650 mm 25.591 in
Material	Stainless steel			
Accessories	Attachment and insulation pipe: 1 pc. each	Attachment and insulation pipe: 1 pc. each, Straight bar nozzle holder: 1 set		

Type	Shape-preserving tube joint nozzle	Conductive tube joint nozzle
Item	ER-VAJK	ER-VAJT-64
Air pressure range	0.02 to 0.5 MPa	0.02 to 0.7 MPa (Maximum applied pressure depends on the tube length. Refer to the following figure)
Material	Stainless steel	Stainless steel
Supplied air flow	30 to 250 l/min. (ANR)	20 to 160 l/min. (ANR) (at applied pressure of 0.02 to 0.7 MPa)
Accessories	Attachment (White): 1pc., Insulation pipe: 1pc.	Attachment (White): 1pc., Insulation pipe: 1pc.

Type	Shape-preserving tube			Conductive tube
Item	ER-VAK10	ER-VAK30	ER-VAK50	ER-AT50
Tube length	112 mm 4.409 in	312 mm 12.283 in	512 mm 20.157 in	500 mm 19.685 in
Material	Tube interior: Aluminum, Tube sheath: High-density polyethylene, Terminal cap: Stainless steel			Urethane
Air pressure range	0.02 to 0.5 MPa			0.02 to 0.7 MPa
Minimum bending radius	R40 mm R1.575 in or more			R15 mm R0.591 in or more

Type	Tube and joint set
Item	ER-VAB-AT
Compatible nozzles	Straight nozzle (effective charge removal length 320 mm 12.598 in or less)
Tube length	500 mm 19.685 in
Material	Nozzle: Stainless steel (SUS), Conductive tube: Urethane
Supplied air flow	Max. 200 l/min. (ANR)
Air pressure range	0.05 to 0.4 MPa
Minimum bending radius	R25 mm R0.984 in (conductive tube portion)
Accessories	Attachment (Black) 1 pc., insulated pipe: 1pc., Straight bar nozzle holder: 1 set

• Correlation between tube length and maximum applied pressure

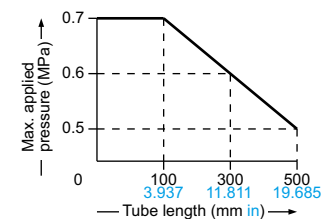

Note: Where measurement conditions have not been specified precisely, the conditions used were an ambient temperature of +20 °C +68 °F.

I/O CIRCUIT AND WIRING DIAGRAMS

ER-VS02

I/O circuit diagram

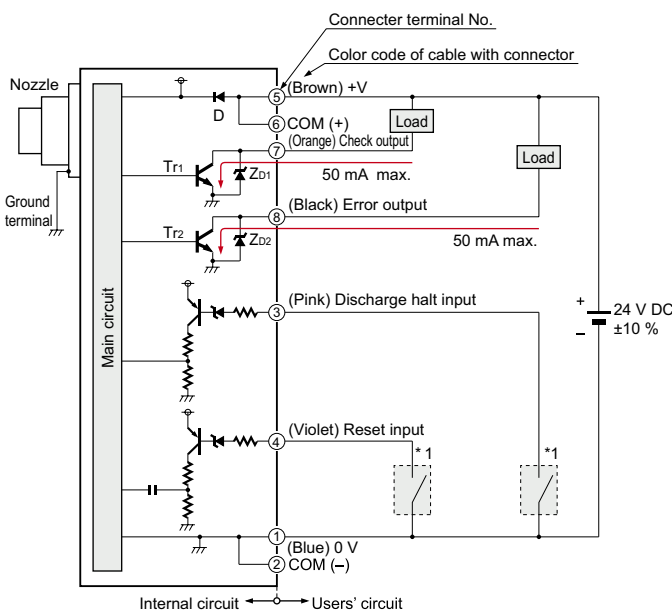

Symbols ... D: Reverse supply polarity protection diode
 ZD1, ZD2: Surge absorption zener diode
 Tr1, Tr2 : NPN output transistor

Connector terminal arrangement

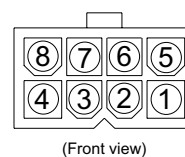

Terminal No.	Description	Color code of cable with connector
①	0 V	Blue
②	COM (-)	—
③	Discharge halt input	Pink
④	Reset input	Violet
⑤	24 V	Brown
⑥	COM (+)	—
⑦	Check output	Orange
⑧	Error output	Black

Note: ① and ② are short-circuited at the connector side.
 ⑤ and ⑥ are short-circuited at the connector side.

Non-voltage contact or NPN open-collector transistor

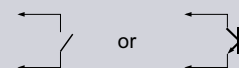

- Discharge halt input
 Low (0 V): Discharge halt
 High (Open): Discharge allowed (Operation starts)
- Reset input
 When abnormal discharge is detected, discharge is halted due to an error.
 Reset the discharge halt by briefly shorting the power supply's 0 V line.

FIBER SENSORS

LASER SENSORS

PHOTO-ELECTRIC SENSORS

MICRO PHOTO-ELECTRIC SENSORS

AREA SENSORS

SAFETY LIGHT CURTAINS / SAFETY COMPONENTS

PRESSURE / FLOW SENSORS

INDUCTIVE PROXIMITY SENSORS

PARTICULAR USE SENSORS

SENSOR OPTIONS

SIMPLE WIRE-SAVING UNITS

WIRE-SAVING SYSTEMS

MEASUREMENT SENSORS

STATIC CONTROL DEVICES

LASER MARKERS

PLC

HUMAN MACHINE INTERFACES

ENERGY MANAGEMENT SOLUTIONS

FA COMPONENTS

MACHINE VISION SYSTEMS

UV CURING SYSTEMS

Selection Guide

Static Removers

Pulse Air-gun

Cleaning Box

Electrostatic Sensor

ER-X

ER-TF

ER-VS02

ER-VW

ER-Q

ER-F

CHARGE REMOVAL CHARACTERISTICS (TYPICAL)

Please contact our office for details on data that is not listed here.

Measured using a 150 mm × 150 mm 5.906 in × 5.906 in CPM (charge plate monitor). (At center of CPM)

Common to all nozzles

Air flow

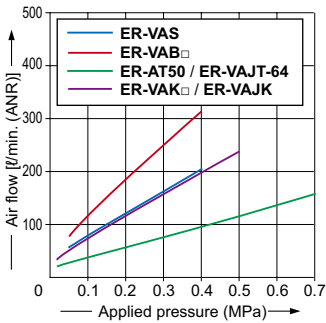

Correlation between charge removal distance and ion balance (Typical: ER-VAS)

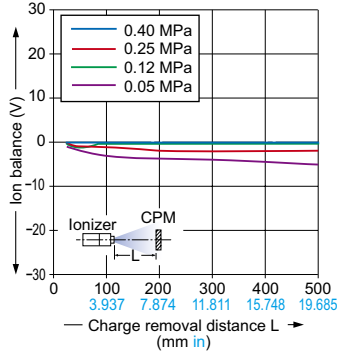

ER-VAS

Shower nozzle

Correlation between charge removal distance and charge removal time

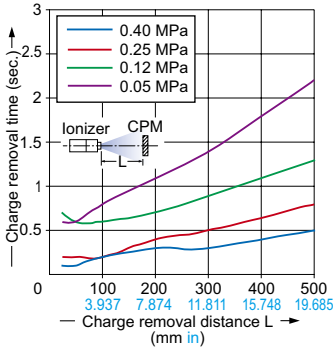

Charge removal field (0.40 MPa)

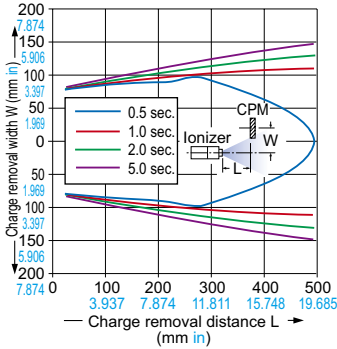

ER-VAB020

Straight bar nozzle

Correlation between charge removal distance and charge removal time

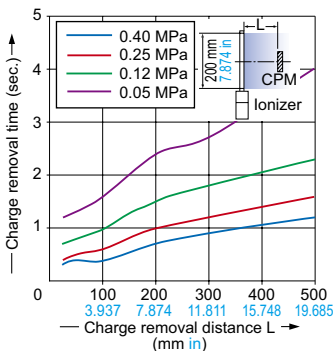

Charge removal field (0.40 MPa)

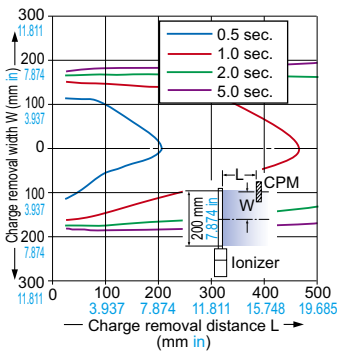

ER-VAB032

Straight bar nozzle

Correlation between charge removal distance and charge removal time

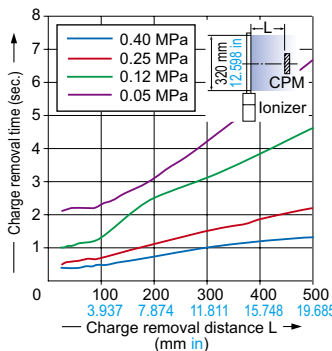

Charge removal field (0.40 MPa)

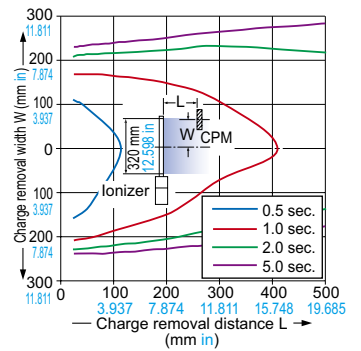

ER-X

ER-TF

ER-VS02

ER-VW

ER-Q

ER-F

ER-VAB065

Straight bar nozzle

Correlation between charge removal distance and charge removal time

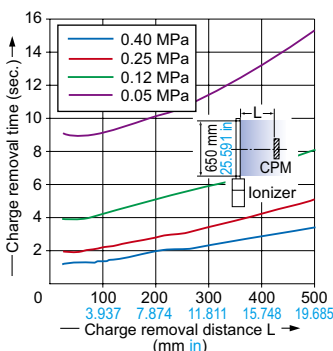

Charge removal field (0.40 MPa)

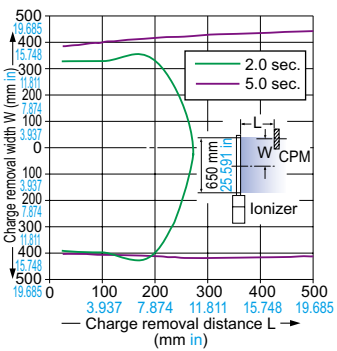

CHARGE REMOVAL CHARACTERISTICS (TYPICAL) Please contact our office for details on data that is not listed here.

ER-VAJK ER-VAK10 Shape-preserving tube joint nozzle, Shape-preserving tube

Correlation between charge removal distance and charge removal time

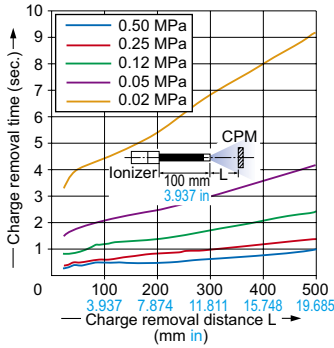

Charge removal field (0.50 MPa)

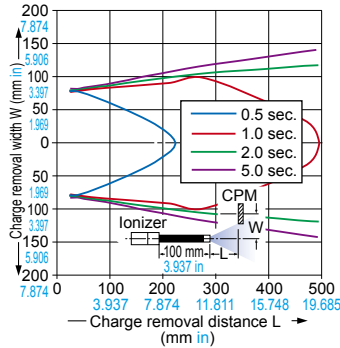

ER-VAJK ER-VAK30 Shape-preserving tube joint nozzle, Shape-preserving tube

Correlation between charge removal distance and charge removal time

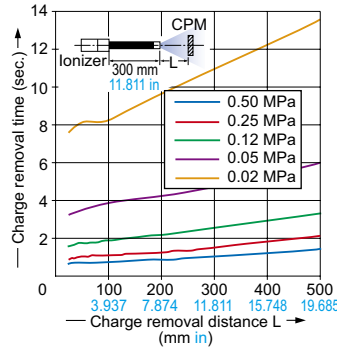

Charge removal field (0.50 MPa)

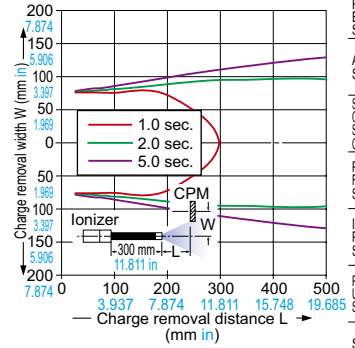

ER-VAJK ER-VAK50 Shape-preserving tube joint nozzle, Shape-preserving tube

Correlation between charge removal distance and charge removal time

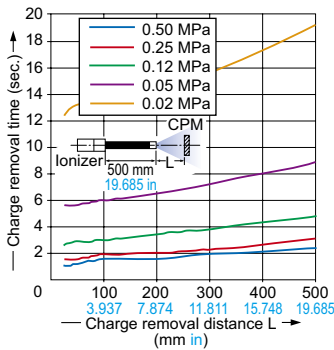

Charge removal field (0.50 MPa)

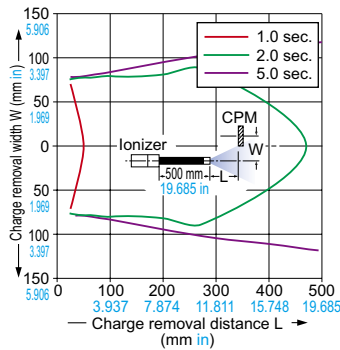

ER-VAJT-64 ER-AT50

Conductive tube joint nozzle, Conductive tube

Correlation between charge removal distance and charge removal time (Tube length 100 mm 3.937 in)

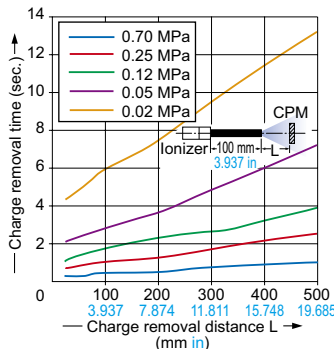

Correlation between charge removal distance and charge removal time (Tube length 300 mm 11.811 in)

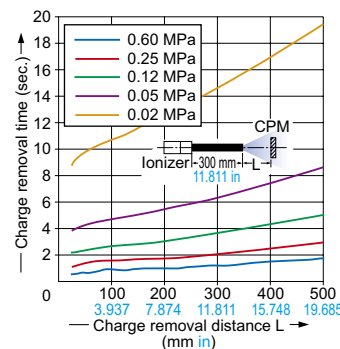

Correlation between charge removal distance and charge removal time (Tube length 500 mm 19.685 in)

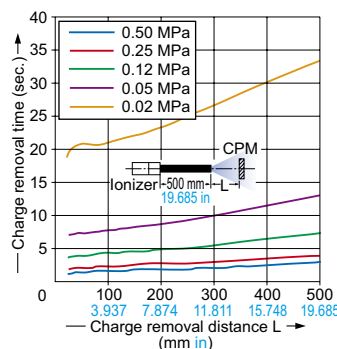

Correlation between tube length and max. applied pressure

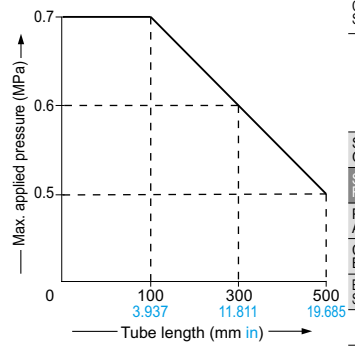

Charge removal field (0.70 MPa) (Tube length 100 mm 3.937 in)

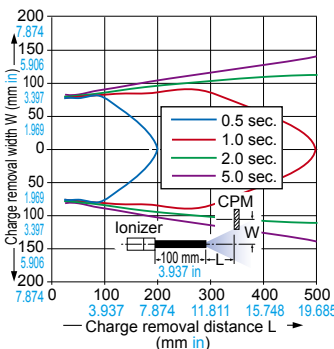

Charge removal field (0.60 MPa) (Tube length 300 mm 11.811 in)

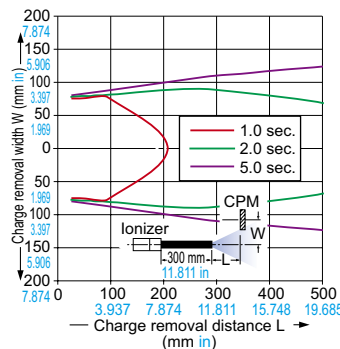

Charge removal field (0.50 MPa) (Tube length 500 mm 19.685 in)

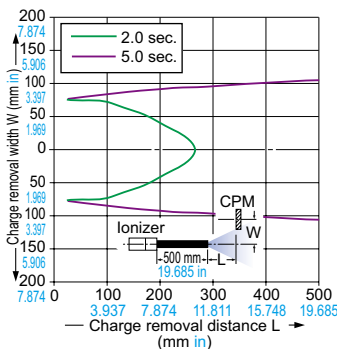

- FIBER SENSORS
- LASER SENSORS
- PHOTO-ELECTRIC SENSORS
- MICRO PHOTO-ELECTRIC SENSORS
- AREA SENSORS
- SAFETY LIGHT CURTAINS / SAFETY COMPONENTS
- PRESSURE / FLOW SENSORS
- INDUCTIVE PROXIMITY SENSORS
- PARTICULAR USE SENSORS
- SENSOR OPTIONS
- SIMPLE WIRE-SAVING UNITS
- WIRE-SAVING SYSTEMS
- MEASUREMENT SENSORS
- STATIC CONTROL DEVICES
- LASER MARKERS
- PLC
- HUMAN MACHINE INTERFACES
- ENERGY MANAGEMENT SOLUTIONS
- FA COMPONENTS
- MACHINE VISION SYSTEMS
- UV CURING SYSTEMS
- Selection Guide
- Static Removers
- Pulse Air-gun
- Cleaning Box
- Electrostatic Sensor
- ER-X
- ER-TF
- ER-VS02
- ER-VW
- ER-Q
- ER-F

PRECAUTIONS FOR PROPER USE

Refer to p.1595 for general precautions.



This product is designed to remove static electricity for industrial use. It is not intended to be used to prevent accidents, either to humans or properties, or for safety maintenance.

Mounting

- When this product is mounted in a housing, use M4 screws (please arrange separately).
- If more than 2 units are mounted close together, keep 5 mm **0.197 in** or more between them. If used at distances within 5 mm **0.197 in**, performance may be affected.
- Ensure sufficient space for daily check and maintenance.
- If AC adapter **ER-VAPS1** is used, be sure to connect the ground terminal to the power supply common earth.
- Make sure to ground this product. If the grounding is not proper, charge removal may be impaired. (Direct earth or power supply common earth)
- If an electrostatically charged object is in contact with or near another object, charge removal may be impaired. Install this product such that ions are blown against the electrostatically charged object, when the object is at a distance from other objects or is floating in mid-air.

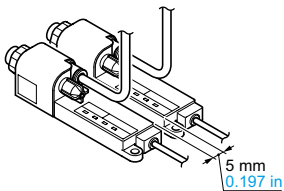

Nozzle



- The ionizer main unit cannot be used by itself. Always be sure to attach a nozzle (optional) before use.
- Never modify the optional nozzle. If the modified nozzle is used, the pressure inside of the nozzle increases, and the check output works as the monitoring function of the discharge part is activated.
- For the details of the optional nozzle, refer to the instruction manual enclosed with the nozzle.

- There are Select the suitable model for your application.
- Appropriate air pressure for each nozzle should be used.
- To fit the air nozzle, screw it to the product till it stops.

Piping

- The outer diameter of the air tube for the air inlet of this product should be $\varnothing 6$ mm **$\varnothing 0.236$ in.**
- Make sure that clean air (air containing no water, no oil and no dust) should be supplied.

Wiring



- Make sure that the power supply is off while wiring. Otherwise, there is a danger of electric shock.

- After wiring, reconfirm the wiring connections before switching on the power supply.
- Note, wrong wiring will damage the product.
- Verify that the supply voltage variation is within the rating.
- Do not run the wires together with high-voltage lines or power lines or put them in the same raceway. This can cause malfunction due to induction.

Maintenance



- Always be sure that the power supply and the air supply are both turned off before inspection and cleaning.
- Since the tip of the discharge needle is pointed, take sufficient care when cleaning.

- The charge removal effect will deteriorate if dirt is stuck to the tip of the discharge needle. If a check signal is output, clean the discharge needle.
- Clean the discharge needle periodically even if no check signal is output.
- The discharge needle's life-time is approximately 20,000 hours. Please change it after this period has elapsed. Use only discharge needle **ER-VANT2** (optional).
- If a check signal is output even after the discharge needle has been cleaned, replace the discharge needle.
- If an error signal is output, it may indicate an abnormal discharge. Check the following points:
 - ① Make sure that the supply voltage is within the tolerance as per specifications.
 - ② Make sure that the discharge needle unit is mounted correctly on the main unit. Check the tip of the discharge needle for a chip or contamination. If the discharge needle is chipped or dirty, clean it or replace it with a new needle.
 - ③ Check that no foreign materials are inside the nozzle, that the nozzle is mounted correctly and that the ionizer is set up correctly.
 - ④ Make sure that the ground terminal is connected completely.
- To reset the ionizer after an error signal has been output, input a reset signal.

Procedure for cleaning

- ① Check that the power supply and the air supply are both turned off.
- ② Remove the discharge needle from the rear of the main unit.
- ③ Remove the dirt on and around the discharge needle with a cotton swab soaked in alcohol.
- ④ Check the discharge needle once more to make sure it is free from foreign particles such as thread scraps.
- ⑤ After cleaning the discharge needle, mount it.

Replacing the discharge needle

- ① Check that the power supply and the air supply are both turned off.
- ② Remove the discharge needle from the rear of the main unit.
- ③ After checking there is no contamination on or around the new discharge needle, mount the nozzle.

PRECAUTIONS FOR PROPER USE

Refer to p.1595 for general precautions.

Others

- Only connect an isolated DC power supply, for example one equipped with an isolating transformer, or the optional AC adapter **ER-VAPS1** to the product.
- If an auto-transformer, etc. (single winding transformer) is used, this product or the power supply may be damaged due to short-circuit.

- Do not use this product beyond its rated specifications. Doing so can cause product breakdown, non-function, or damage. Furthermore, it will also cause a marked reduction in product life.
- Never disassemble, repair, modify, or misuse this product, as this can cause an accident or malfunction.
- Do not throw this product into fire: it may explode or generate poisonous gas.
- Since high voltage is applied to the discharge needle, keep your fingers, body, metal, e.g. wires or tools, etc., away from the needle. If you fail to keep away from the needle, electric shock or malfunction may be the result.
- This product is not explosion-proof. Do not use it in places where combustible or flammable material is present. There is a danger of catching fire.
- If the power supply is switched on immediately after being switched off, fault output may be generated. After the power supply is switched off, wait at least 1 sec. before switching it on again.

- Do not use this product in steamy or dusty places, in places where water and oil splash, or where spatter flies when welding.
- Since this product emits ozone into the atmosphere, circulate air to prevent foul smells. If ozone lingers for long periods, metals, etc. may oxidize / decay. Furthermore, do not try to confirm that foul smells are caused by the ozone by drawing your face near the nozzle outlet and air outlet: you may hurt your nose, throat, etc.
- Confirm the wiring and piping state before supplying power or air. Wrong wiring and piping may cause malfunction.
- Do not use this product for any purpose other than charge removal.
- When this product is no longer usable or required, dispose of properly as industrial waste.
- If the air supplied to this product is turned ON/OFF by a solenoid valve, for example, make sure to turn the discharge halt input ON/OFF simultaneously.
- Use air (dry, clean air) for the fluid. Any fluid other than air (dry, clean air) or even air containing corrosive gas may cause an accident or malfunction.
- Do not use air that contains foreign particles, e.g. carbon dust, dust, water or oil. Since these substances may cause electric shock or malfunction, take appropriate countermeasures, e.g. install an airfilter, air-drier, etc.

Mini line filter**Specifications**

Designation		Mini line filter	
Item	Model No.	ER-AF10	ER-AF20
Applicable ionizer		ER-VS02, ER-SP□	
Applicable fluid		Air	
Pipe connection port		R 1/8, Rc 1/8	R 1/4, Rc 1/4
Collected particle dia.		0.1 μm 0.0004 mil	
Collection efficiency		99.9 %	
Processed air volume (Note)		40 l/min. (ANR)	80 l/min. (ANR)
Membrane area		29.9 cm ²	68.7 cm ²
Max. operating pressure		0.97 MPa	
Warranted withstand pressure		1.47 MPa	
Ambient temperature		+5 to +45 °C +41 to +113 °F	
Material		Main body: Aluminum alloy (Almite processed) Element: Porous, hollow fiber membrane	
Net weight		11 g approx.	18 g approx.

Note: Maximum processed air volume that the filter performance can be maintained.
Approximately 0.1 MPa of pressure drop occurs with the max. processed air volume.

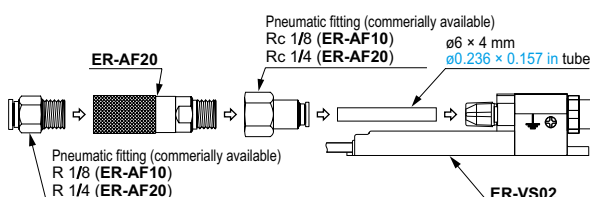
Piping**<Mounting example of ER-AF20 + ER-VS02>**

- Fit the pneumatic fittings on the both sides of this product to connect to the pneumatic tube, as the figure shown above.

Notes: 1) Since this product is made by aluminum alloy, make sure that excessive force is not applied.
2) This product is for removal of solid particles. Remove water, oil, etc., in the primary pressure side.

Cautions

- Before the piping, make sure to sufficiently carry out internal flashing (blowing of compressed air) of the pipe. If scrap or sealing tape, generated during work, or rust, etc., gets inserted, it will cause clogging.
- Use air (dry, clean air) which does not contain water, oil, etc. Water or oil will cause clogging or reduction in performance.
- Do not use with a fluid or in an environment containing the following substances:
 - Organic solvents, Ester phosphate type hydraulic fluid
 - Sulfuric acid gas, Chlorine gas, Acids
- This product is for industrial use. Do not use it in equipment affecting human life.
- Never disassemble or modify this product.
- When disposing this product, dispose it as industrial waste.

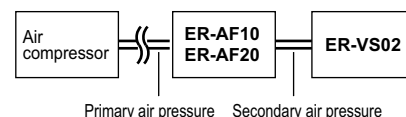
Pressure drop

- When the mini line filter (**ER-AF10/AF20**) is fitted, a pressure drop occurs. Adjust the primary air pressure so that the secondary air pressure is within the air pressure range of the ionizer. (Take care that the air pressure range differs depending on the nozzle. Furthermore, in case the filter is used with the max. processed air volume, approximately 0.1 MPa of pressure drop occurs.)
- Take care that if the air more than the specified processed air volume is applied, the efficiency will deteriorate.

FIBER SENSORS

LASER SENSORS

PHOTO-ELECTRIC SENSORS

MICRO PHOTO-ELECTRIC SENSORS

AREA SENSORS

SAFETY LIGHT CURTAINS / SAFETY COMPONENTS

PRESSURE / FLOW SENSORS

INDUCTIVE PROXIMITY SENSORS

PARTICULAR USE SENSORS

SENSOR OPTIONS

SIMPLE WIRE-SAVING UNITS

WIRE-SAVING SYSTEMS

MEASUREMENT SENSORS

STATIC CONTROL DEVICES

LASER MARKERS

PLC

HUMAN MACHINE INTERFACES

ENERGY MANAGEMENT SOLUTIONS

FA COMPONENTS

MACHINE VISION SYSTEMS

UV CURING SYSTEMS

Selection Guide

Static Removers

Pulse Air-gun

Cleaning Box

Electrostatic Sensor

ER-X**ER-TF****ER-VS02****ER-VW****ER-Q****ER-F**

DIMENSIONS (Unit: mm in)

The CAD data can be downloaded from our website.

ER-VS02

Ionizer main unit

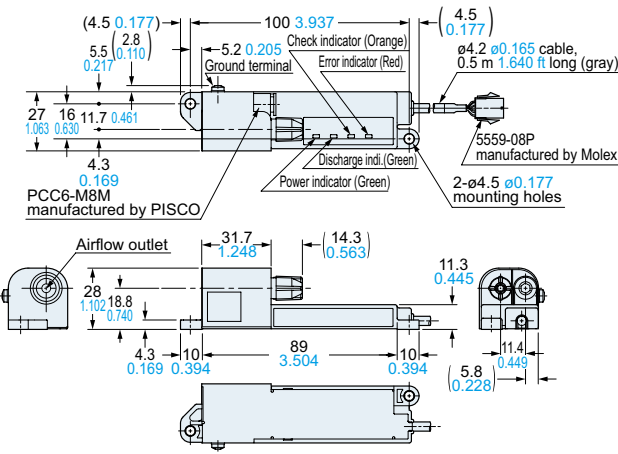

Mounting drawing with shower nozzle (ER-VAS, Optional)

Mounting drawing with shape-preserving tube and joint nozzle (ER-VAK□, ER-VAJK, Optional)

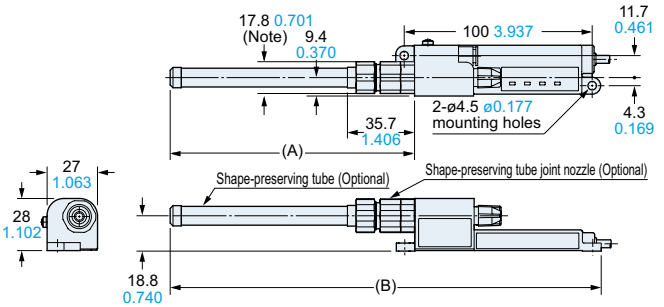
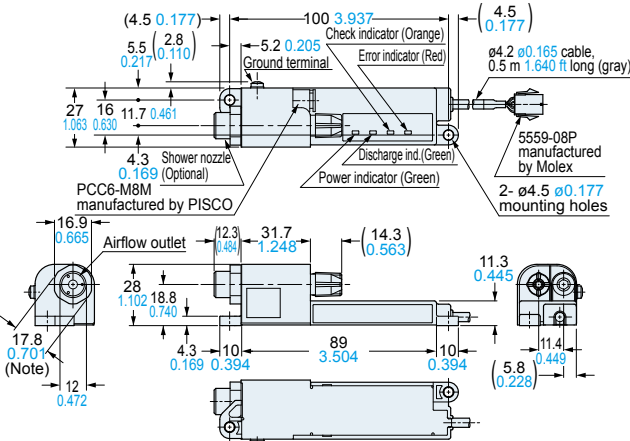

Note: Hexagonal clamping part is 16.9 mm 0.665 in.

Model No.	A	B
ER-VAK10	130 5.118	229.3 9.028
ER-VAK30	330 12.992	429.3 16.902
ER-VAK50	530 20.866	629.3 24.776

Note: Hexagonal clamping part is 16.9 mm 0.665 in.

Mounting drawing with straight bar nozzle (ER-VAB□, Optional)

Mounting drawing with conductive tube joint nozzle (ER-VAJT-64, Optional)

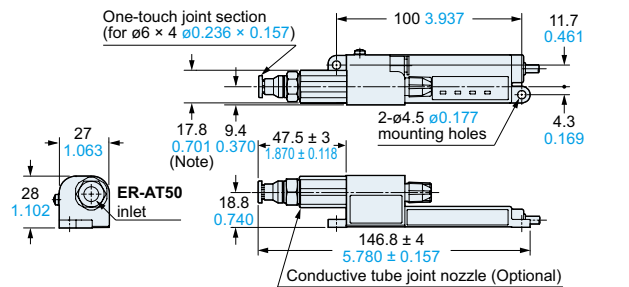
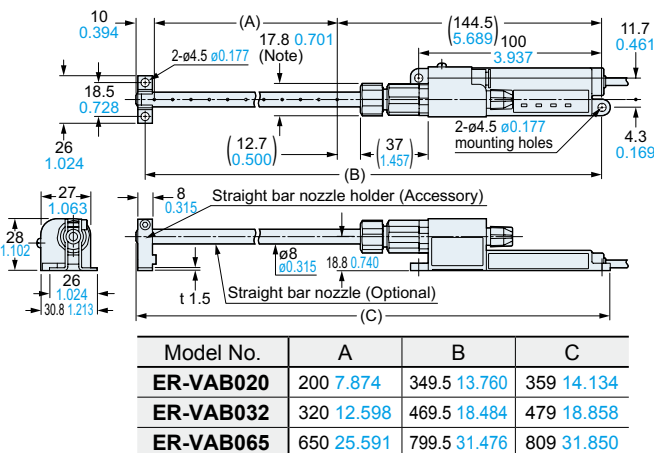

Note: Hexagonal clamping part is 16.9 mm 0.665 in.

Model No.	A	B	C
ER-VAB020	200 7.874	349.5 13.760	359 14.134
ER-VAB032	320 12.598	469.5 18.484	479 18.858
ER-VAB065	650 25.591	799.5 31.476	809 31.850

Note: Hexagonal clamping part is 16.9 mm 0.665 in.

- FIBER SENSORS
- LASER SENSORS
- PHOTO-ELECTRIC SENSORS
- MICRO PHOTO-ELECTRIC SENSORS
- AREA SENSORS
- SAFETY LIGHT CURTAINS / SAFETY COMPONENTS
- PRESSURE / FLOW SENSORS
- INDUCTIVE PROXIMITY SENSORS
- PARTICULAR USE SENSORS
- SENSOR OPTIONS
- SIMPLE WIRE-SAVING UNITS
- WIRE-SAVING SYSTEMS
- MEASUREMENT SENSORS
- STATIC CONTROL DEVICES
- LASER MARKERS
- PLC
- HUMAN MACHINE INTERFACES
- ENERGY MANAGEMENT SOLUTIONS
- FA COMPONENTS
- MACHINE VISION SYSTEMS
- UV CURING SYSTEMS
- Selection Guide
- Static Removers
- Pulse Air-gun
- Cleaning Box
- Electrostatic Sensor
- ER-X
- ER-TF
- ER-VS02
- ER-VW
- ER-Q
- ER-F

DIMENSIONS (Unit: mm in)

Please contact our office for details on data that is not listed here.
The CAD data can be downloaded from our website.

ER-VAJK Shape-preserving tube joint nozzle (Optional)

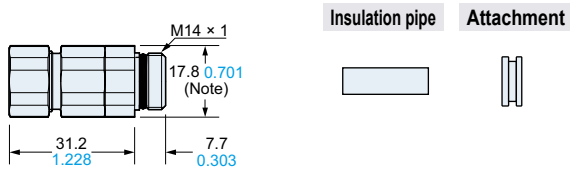

Note: Hexagonal clamping part is 16.9 mm 0.665 in.

ER-VAJT-64 Conductive tube joint nozzle (Optional)

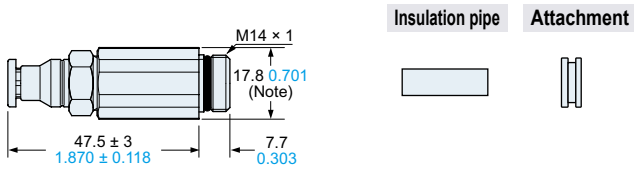

Note: Hexagonal clamping part is 16.9 mm 0.665 in.

ER-ATH Conductive tube holder (Optional)

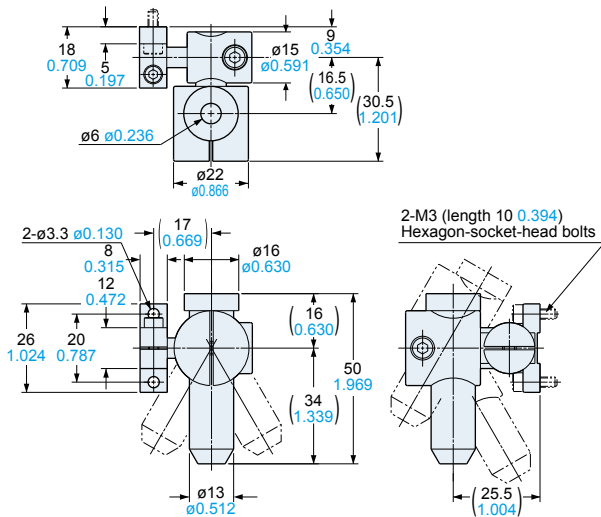

ER-VAK□ Shape-preserving tube (Optional)

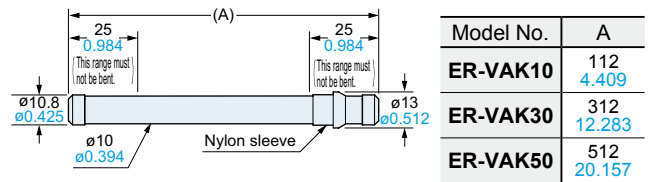

ER-AT50 Conductive tube (Optional)

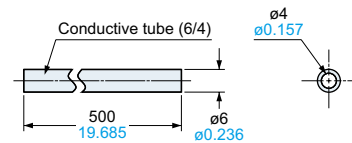

ER-AF10 Mini line filter (Optional)

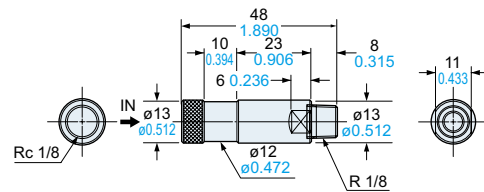

ER-AF20 Mini line filter (Optional)

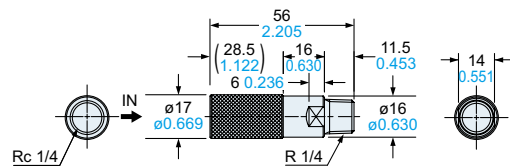

ER-VAPS1 AC adapter (Optional)

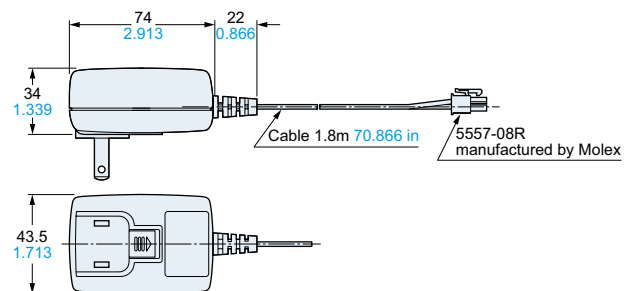

FIBER SENSORS

LASER SENSORS

PHOTO-ELECTRIC SENSORS

MICRO PHOTO-ELECTRIC SENSORS

AREA SENSORS

SAFETY LIGHT CURTAINS / SAFETY COMPONENTS

PRESSURE / FLOW SENSORS

INDUCTIVE PROXIMITY SENSORS

PARTICULAR USE SENSORS

SENSOR OPTIONS

WIRE-SAVING UNITS

WIRE-SAVING SYSTEMS

MEASUREMENT SENSORS

STATIC CONTROL DEVICES

LASER MARKERS

PLC

HUMAN MACHINE INTERFACES

ENERGY MANAGEMENT SOLUTIONS

FA COMPONENTS

MACHINE VISION SYSTEMS

UV CURING SYSTEMS

Selection Guide

Static Removers

Pulse Air-gun

Cleaning Box

Electrostatic Sensor

ER-X

ER-TF

ER-VS02

ER-VW

ER-Q

ER-F

X-ON Electronics

Largest Supplier of Electrical and Electronic Components

Click to view similar products for [panasonic](#) manufacturer:

Other Similar products are found below :

[ECE-A1HKAR47](#) [ELC-09D151F](#) [HC2-H-DC48V-F](#) [HL2-HP-AC120V-F](#) [HL2-H-DC12V-F](#) [HL2-HP-DC12V-F](#) [HL2-HP-DC6V-F](#) [HL2-HP-DC24V-F](#) [HL2-H-DC110V-F](#) [HC4-H-DC24V](#) [HL2-HTM-DC24V-F](#) [HL2-HTM-AC24V-F](#) [HC4-H-AC24V](#) [HC4-H-AC120V](#) [HC4-H-DC12V](#) [AZH2031](#) [RP-SDMF64DA1](#) [EVM-F6SA00B55](#) [RP-SMLE08DA1](#) [ERZ-V20R391](#) [ELL-ATV681M](#) [ERZ-V05V680CB](#) [LT4H-DC24V](#) [LT4HL8-AC24V](#) [LT4HW-AC24V](#) [LT4HWT8-AC240V](#) [LT4HWT-AC240VS](#) [CY-122A-P](#) [ETQ-P5M470YFM](#) [EVAL_PAN1555](#) [EVQ-PAE04M](#) [EX-14B](#) [EX-22B-PN](#) [EX-31A-C5](#) [EXB-24N121JX](#) [EX-F72-PN](#) [EX-L211](#) [EYG-A121803V](#) [FCR-M50-AC208V](#) [FC-SFBH-20](#) [FC-SFBH-24](#) [FD-F8Y](#) [MHMA102A1C](#) [MHMD022S1S](#) [MHMD041S1S](#) [MHMD042G1T](#) [MHMD082G1T](#) [FD-S9](#) [FP0-LDR](#) [FP2-AD8X](#)