

Power Choke Coil

Series: **PCC-D125H (NX2)**

Low profile, High power, Low loss



■ Features

- High power, high inductance (No saturation performance limitation due to metal dust core)
(17 A to 50 A/2.12 μH to 0.24 μH)
- Low loss due to low R_{DC} (using flat wire)
- Low buzz noise due to its gap-less structure
- Surface mount, low profile
(H) 4.9 mm×(L)13.0 mm×(W)12.9 mm
- RoHS compliant

■ Recommended Applications

- DC-DC converter for CPU in PCs
- Thin on-board power supply modules for servers

■ Standard Packing Quantity

- 500 pcs./Reel

■ Explanation of Part Numbers

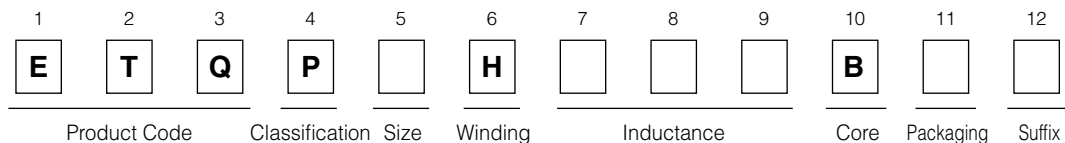

■ Standard Parts

Part No.	Inductance (at 20 °C)*1					Rated current (A)*2	DC resistance (at 20 °C) (mΩ) max.
	L1			L2 (Reference)			
	(μH)	Tolerance (%)	Measurement current (A)	(μH)	Measurement current (A)		
ETQP2H0R3BFA	0.29	±20	36	0.24	50	36	0.54
ETQP2H0R7BFA	0.69		21	0.59	29	21	1.30
ETQP2H1R2BFA	1.22		16	1.04	22	16	2.27
ETQP2H1R8BFA	1.83		14	1.49	20	14	3.48
ETQP2H2R6BFA	2.61		12	2.12	17	12	4.98

(*1) Inductance is measured at 100 kHz.

(*2) Rated current defines actual value of DC current, when temperature rise of coil becomes 40 K.

Performance Characteristics (Reference)

Inductance vs DC Current

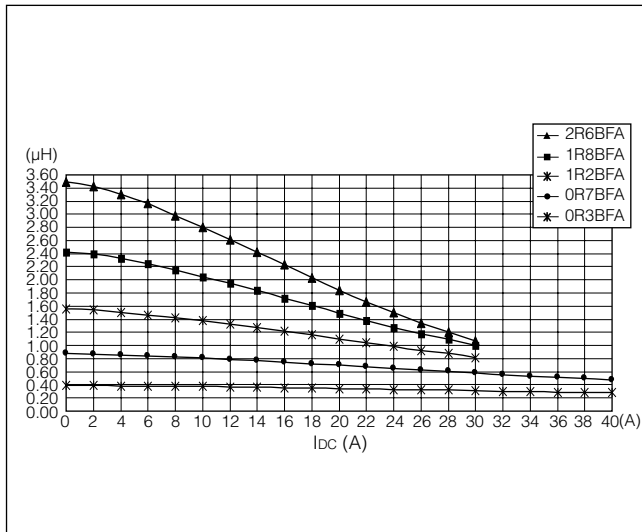

Case temperature vs DC Current

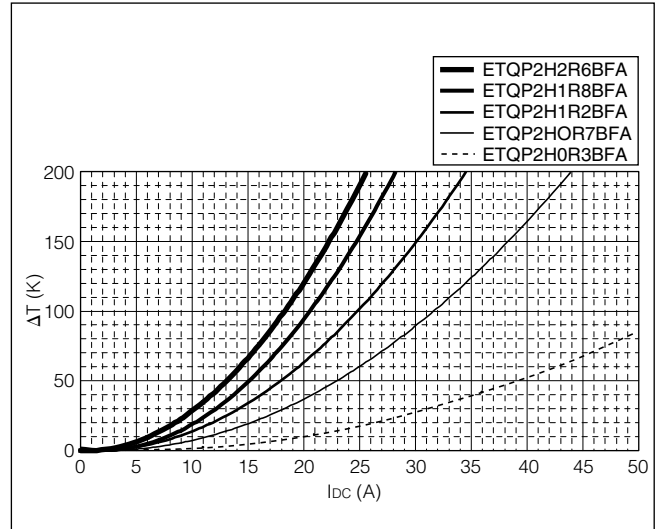

Dimensions in mm (not to scale)

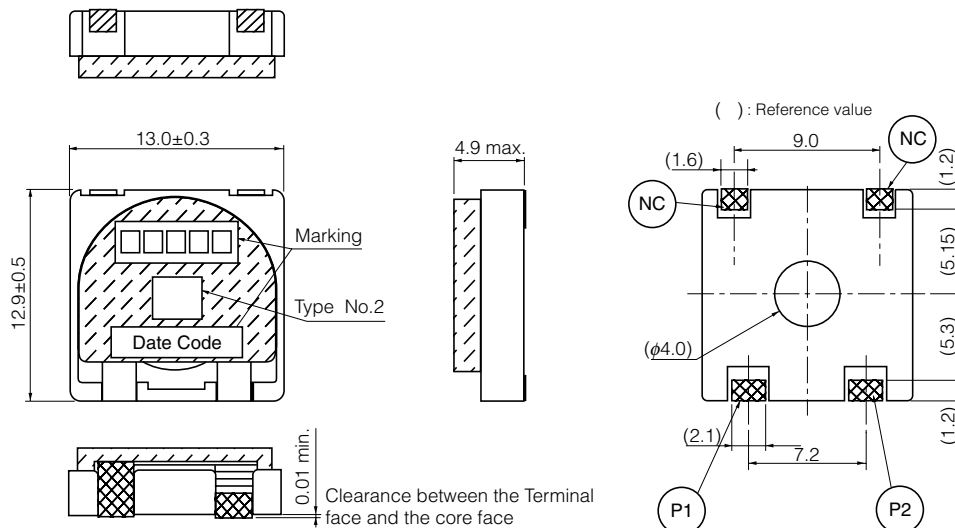

Connection

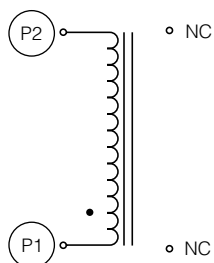

Recommended Land Pattern in mm (not to scale)

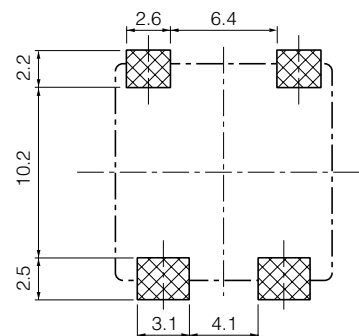

Packaging Methods, Soldering Conditions and Safety Precautions (Power Choke Coils for Consumer use)

Please see Data Files

■ Packaging Methods (Taping)

● Embossed Carrier Tape Dimensions in mm (not to scale)

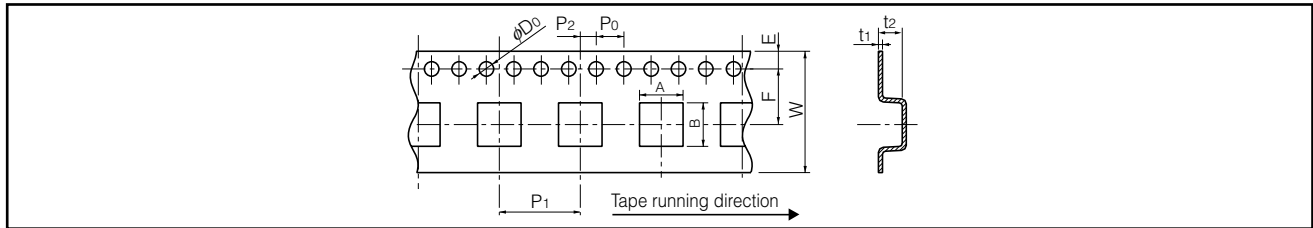

Power Choke Coils for high reliability use

Series	A	B	W	E	F	P ₁	P ₂	P ₀	φD ₀	t ₁	t ₂								
PCC-M0530M	5.6	6.1	16.0	1.75	7.5	12.0	2.0	4.0	1.5	0.4	3.3								
PCC-M0540M											4.3								
PCC-M0630M	7.1	6.6									16.0	1.75	7.5	12.0	2.0	4.0	1.5	3.3	
PCC-M0645M																		5.0	
PCC-M0754M	8.1	7.6									16.0	1.75	7.5	12.0	2.0	4.0	1.5	0.4	6.0
PCC-M0854M/M0850M	9.1	8.6																	
PCC-M1054M/M1050M PCC-M1050ML/M1060ML	10.7	11.9	24.0	1.75	11.5	16.0	2.0	4.0	1.5	0.5	6.3								

Power Choke Coils for consumer use

Series	A	B	W	E	F	P ₁	P ₂	P ₀	φD ₀	t ₁	t ₂
PCC-M0512W	5.6	5.85	12.0	1.75	5.5	8.0	2.0	4.0	1.5	0.4	1.4
PCC-M0630L	7.1	8.0			7.5						12.0
PCC-M0630W	7.2	7.5	7.5		12.0	3.3					
PCC-M0730L	7.6	8.9				4.2					
PCC-M074L	7.6	8.9	7.5		12.0	4.3					
PCC-M104W	10.6	11.0				11.5					16.0
PCC-M104L	10.6	11.8	24.0	11.5	16.0		5.3				
PCC-M125L	13.1	14.8				13.5	13.5	13.0	5.2		
PCC-D124H	13.5	13.5	24.0	11.5	16.0				6.2		
PCC-D125H						5.2					
PCC-D126H	13.0	13.0	24.0	11.5	16.0	6.0					
PCC-D126F						6.0					
PCC-F126F	13.0	13.0	24.0	11.5	16.0	2.0	4.0	1.5	0.4	6.0	

● Taping Reel Dimensions in mm (not to scale)

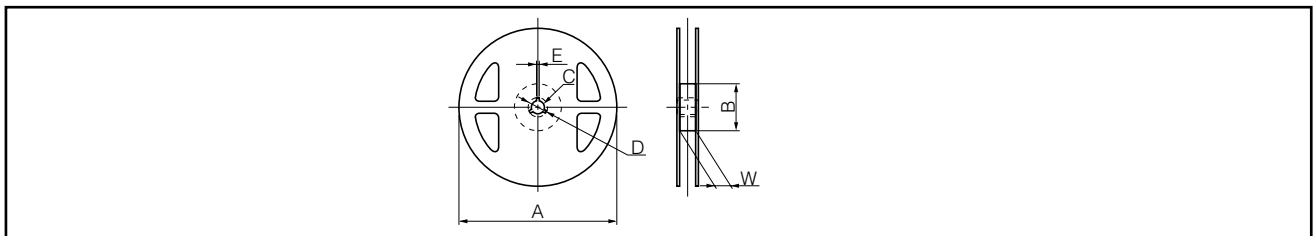

Power Choke Coils for high reliability use

Series	A	B	C	D	E	W
PCC-M0530M/M0540M PCC-M0630M/M0645M PCC-M0754M PCC-M0854M/M0850M	330	100	13	21	2	17.5
PCC-M1054M/M1050M PCC-M1050ML/M1060ML						25.5

Power Choke Coils for consumer use

Series	A	B	C	D	E	W
PCC-M0512W	330	(80)	13	21	2	13.5
PCC-M0630L/M0630W		17.5				
PCC-M104W		25.5				
PCC-M0730L/M074L PCC-M104L	380	80	13	21	2	17.5
PCC-M125L/D124H/D125H/ D126H/D126F/F126F						25.4

■ Component Placement (Taping)

● Power Choke Coils for high reliability use

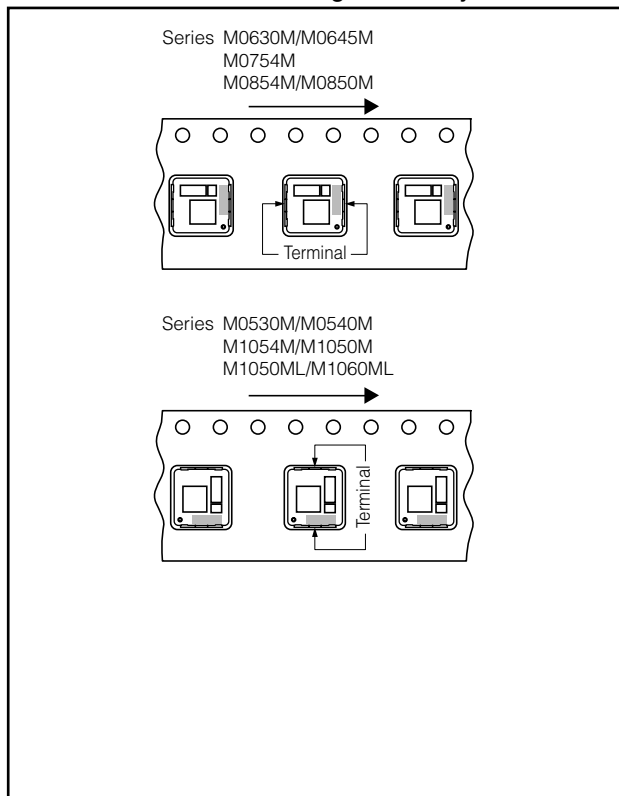

● Power Choke Coils for consumer use

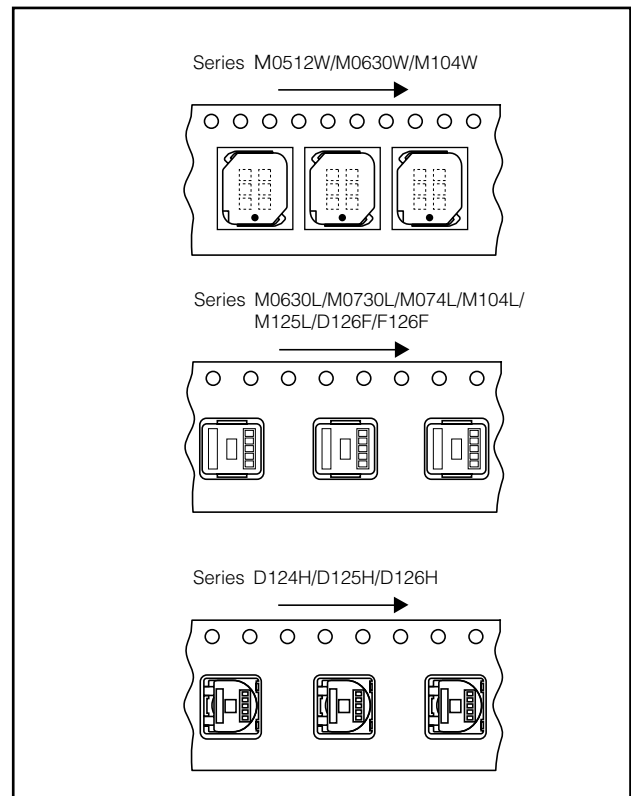

■ Standard Packing Quantity/Reel

● Power Choke Coils for high reliability use

Series	Minimum Quantity / Packing Unit	Quantity per reel
PCC-M0530M/M0540M	2000 pcs. / box (2 reel)	1000 pcs.
PCC-M0630M		
PCC-M0645M	1000 pcs. / box (2 reel)	500 pcs.
PCC-M0754M		
PCC-M0854M/M0850M		
PCC-M1054M/M1050M		
PCC-M1050ML/M1060ML		

● Power Choke Coils for consumer use

Series	Minimum Quantity / Packing Unit	Quantity per reel
PCC-M0512W	6000 pcs. / box (2 reel)	3000 pcs.
PCC-M0730L	3000 pcs. / box (2 reel)	1500 pcs.
PCC-M074L		
PCC-M0630L	2000 pcs. / box (2 reel)	1000 pcs.
PCC-M0630W		
PCC-M104L		
PCC-M104W	1000 pcs. / box (2 reel)	500 pcs.
PCC-M125L		
PCC-D124H		
PCC-D125H		
PCC-D126H		
PCC-D126F		
PCC-F126F		

Soldering Conditions

■ Reflow soldering conditions

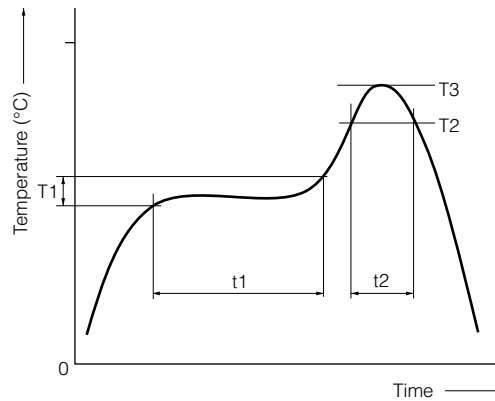

● Pb free solder recommended temperature profile
Power Choke Coils for high reliability use

Series	Preheat		Soldering		Peak Temperature		Time of Reflow
	T1 [°C]	t1 [s]	T2 [°C]	t2 [s]	T3	T3 Limit	
PCC-D1413H PCC-M0530M/M0540M PCC-M0630M/M0645M PCC-M0754M PCC-M0854M/M0850M PCC-M1054M/M1050M PCC-M1050ML/M1060ML	150 to 170	60 to 120	230 °C	30 to 40	250 °C, 5 s	260 °C, 10 s	2 times max.

Power Choke Coils for consumer use

Series	Preheat		Soldering		Peak Temperature		Time of Reflow
	T1 [°C]	t1 [s]	T2 [°C]	t2 [s]	T3	T3 Limit	
PCC-M0512W PCC-M0630L PCC-M0630W PCC-M0730L PCC-M074L PCC-M104L PCC-M104W PCC-M125L PCC-D124H PCC-D125H PCC-D126H PCC-D126F PCC-F126F	150 to 170	60 to 120	230 °C	30 to 40	250 °C, 5 s	260 °C, 10 s	2 times max.

⚠ Safety Precautions

(Common precautions for Power Choke Coils for consumer use)

- When using our products, no matter what sort of equipment they might be used for, be sure to make a written agreement on the specifications with us in advance. The design and specifications in this catalog are subject to change without prior notice.
- Do not use the products beyond the specifications described in this catalog.
- This catalog explains the quality and performance of the products as individual components. Before use, check and evaluate their operations when installed in your products.
- Install the following systems for a failsafe design to ensure safety if these products are to be used in equipment where a defect in these products may cause the loss of human life or other significant damage, such as damage to vehicles (automobile, train, vessel), traffic lights, medical equipment, aerospace equipment, electric heating appliances, combustion/gas equipment, rotating equipment, and disaster/crime prevention equipment.
 - * Systems equipped with a protection circuit and a protection device
 - * Systems equipped with a redundant circuit or other system to prevent an unsafe status in the event of a single fault

⚠ Precautions for use

1. Provision to abnormal condition

This power choke coil itself does not have any protective function in abnormal condition such as overload, short-circuit and open-circuit conditions, etc.

Therefore, it shall be confirmed as the end product that there is no risk of smoking, fire, dielectric withstand voltage, insulation resistance, etc. in abnormal conditions to provide protective devices and/or protection circuit in the end product.

2. Temperature rise

Temperature rise of power choke coil depends on the installation condition in end products. It shall be confirmed in the actual end product that temperature rise of power choke coil is in the limit of specified temperature class.

3. Dielectric strength

Dielectric withstanding test with higher voltage than specific value will damage Insulating material and shorten its life.

4. Water

This Power choke coil must not be used in wet condition by water, coffee or any liquid because insulation strength becomes very low in the condition.

5. Potting

If this power choke coil is potted in some compound, coating material of magnet wire might be occasionally damaged. Please ask us if you intend to pot this power choke coil.

6. Detergent

Please consult our company in case of this because the confirmation of reliability etc. is needed when the washing is used for the power choke coil.

7. Storage temperature

-5 °C to +35 °C

8. Operating temperature

Minimum temperature : -40 °C(Ambient temperature of the power choke coil)

Maximum temperature : 130 °C(Ambient temperature of the power choke coil plus the temperature rise)

100 °C(Only series : PCC-F126F(N6))

9. Model

When this power choke coil was used in a similar or new product to the original one, sometimes it might be unable to satisfy the specifications due to difference of condition of usage.

Please ask us if you would use this power choke coil in the manner such as above.

10. Drop

If the power choke coil suffered mechanical stress such as drop, characteristics may become poor (due to damage on coil bobbin, etc.). Never use such stressed power choke coil.

<Package markings>

Package markings include the product number, quantity, and country of origin.

In principle, the country of origin should be indicated in English.

X-ON Electronics

Largest Supplier of Electrical and Electronic Components

Click to view similar products for [Fixed Inductors](#) category:

Click to view products by [Panasonic](#) manufacturer:

Other Similar products are found below :

[CR43NP-680KC](#) [CR54NP-820KC](#) [CR54NP-8R5MC](#) [CTX32CT-100](#) [70F224AI](#) [MGDQ4-00004-P](#) [MHL1ECTTP18NJ](#) [MHL1JCTTD12NJ](#)
[PE-51506NL](#) [PE-53601NL](#) [PE-53602NL](#) [PE-53630NL](#) [PE-53824SNLT](#) [PE-62892NL](#) [PE-92100NL](#) [PG0434.801NLT](#) [PG0936.113NLT](#)
[9310-16](#) [PM06-2N7](#) [PM06-39NJ](#) [A01TK](#) [1206CS-471XJ](#) [HC2-2R2TR](#) [HC2LP-R47-R](#) [HC3-2R2-R](#) [HCF1305-3R3-R](#) [1206CS-151XG](#)
[RCH664NP-140L](#) [RCH664NP-4R7M](#) [RCH8011NP-221L](#) [RCP1317NP-332L](#) [RCP1317NP-391L](#) [RCR1010NP-470M](#) [RCR110DNP-331L](#)
[DH2280-4R7M](#) [DS1608C-106](#) [ASPI-4020HI-R10M-T](#) [B10TJ](#) [B82477P4333M](#) [B82498B3101J000](#) [B82498B3680J000](#) [ELJ-RE27NJF2](#)
[1812CS-153XJ](#) [1812CS-183XJ](#) [1812CS-223XJ](#) [1812LS-104XJ](#) [1812LS-105XJ](#) [1812LS-124XJ](#) [1812LS-154XJ](#) [1812LS-223XJ](#)