

### 4.7 mm×3.5 mm Double-action Side-operational SMD Light Touch Switches

Type: **EVPAJ**



#### ■ Features

- External dimensions : 4.7 mm×3.5 mm (Without push plate), Height : 1.2 mm
- With ground terminal

#### ■ Recommended Applications

- Camera function  
(Digital still cameras, Camcorders, Mobile phones, etc.)
- Operating switches for menu scrolling and confirmation for portable equipment.

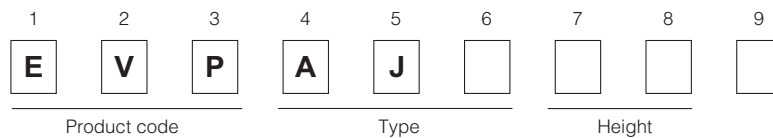

#### ■ Explanation of Part Numbers



#### ■ Specifications

Type	Snap action/Push-on type SPDT	
	Rating	10 $\mu$ A 2 Vdc to 20 mA 15 Vdc (Resistive load)
	Contact Resistance	500 m $\Omega$ max.
	Insulation Resistance	100 M $\Omega$ min. (at 100 Vdc)
	Dielectric Withstanding Voltage	250 Vac for 1 minute
	Bouncing	3 ms max. (ON) 20 ms max. (OFF)
Mechanical	Operating Force (1st Action)	1.6 N
	Operating Force (2nd Action)	2.6 N
	Travel (1st Action)	0.15 mm
	Travel (2nd Action)	0.4 mm
	Push Strength	30 N for 15 seconds
Endurance	Operating Life	100000 cycles min.
Operating Temperature		-20 °C to +70 °C
Storage Temperature		-40 °C to +85 °C (Bulk) -20 °C to +60 °C (Taping)
Minimum Quantity/Packing Unit		5000 pcs. Embossed Taping (Reel Pack)
Quantity/Carton		25000 pcs.

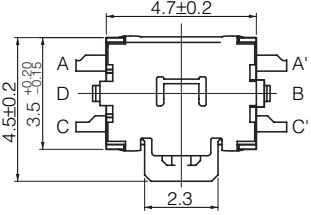
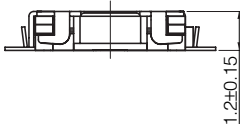
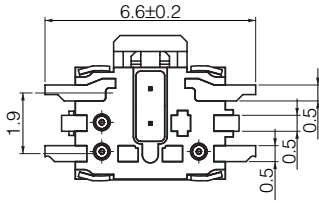
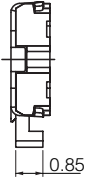
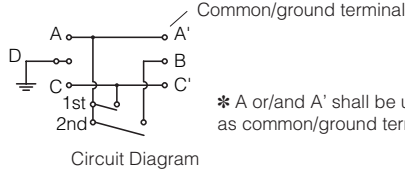
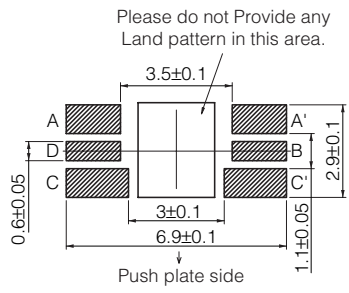
■ Dimensions in mm (not to scale)

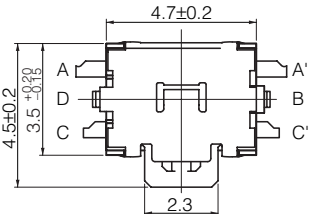
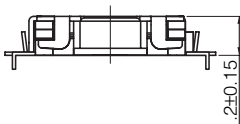
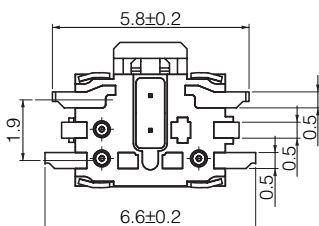
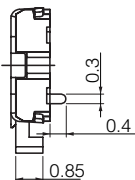
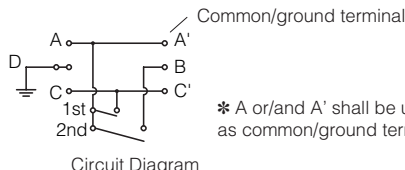
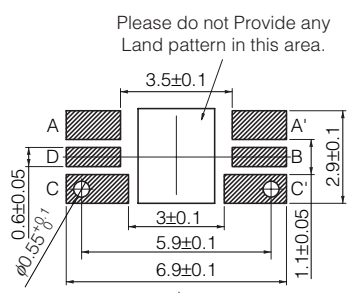
<p>EVPAJ</p> <p>(Embossed Taping) With Ground Terminal</p> <p>Part Numbers : EVPAJAC1A</p> 	     <p>Circuit Diagram</p> <p>* A or/and A' shall be used as common/ground terminal.</p> <p>Please do not Provide any Land pattern in this area.</p>  <p>Push plate side</p> <p>PWB land pattern for reference(View from mounting side)</p>
<p>EVPAJ</p> <p>L-shape</p> <p>Part Numbers : EVPAJAE1A</p> 	     <p>Circuit Diagram</p> <p>* A or/and A' shall be used as common/ground terminal.</p> <p>Please do not Provide any Land pattern in this area.</p>  <p>Push plate side</p> <p>PWB land pattern for reference(View from mounting side)</p>

### Recommended Reflow Soldering Conditions

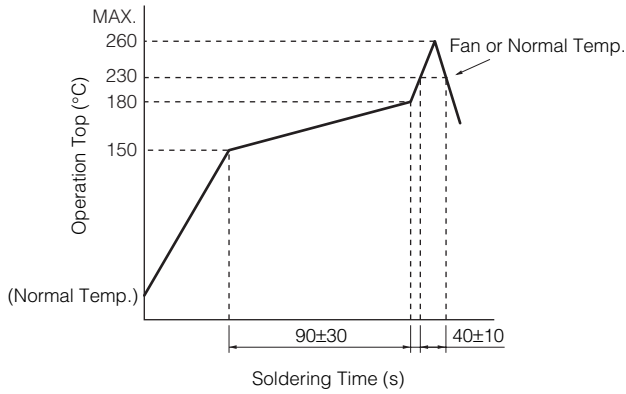

### Embossed Carrier Taping

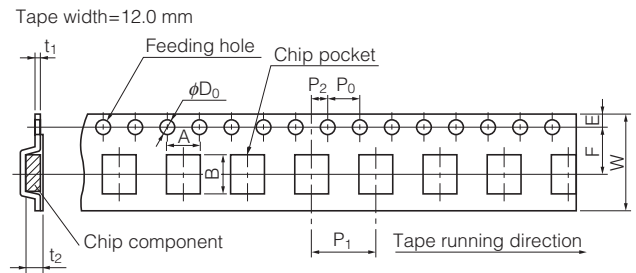

Unit: mm

Part No.	Height	A	B	W	F	E	P <sub>1</sub>	P <sub>2</sub>	P <sub>0</sub>	D <sub>0</sub> Dia.	t <sub>1</sub>	t <sub>2</sub>
EVPAJ	1.2	6.8±0.2	4.9±0.2	12.0 <sup>+0.3</sup> <sub>-0.1</sub>	5.78±0.1	1.75±0.1	8.0±0.1	2.0±0.1	4.0±0.1	1.5 <sup>+0.1</sup> <sub>-0</sub>	0.3±0.05	1.95 <sup>+0.3</sup> <sub>-0</sub>

### Standard Reel Dimensions in mm (not to scale)

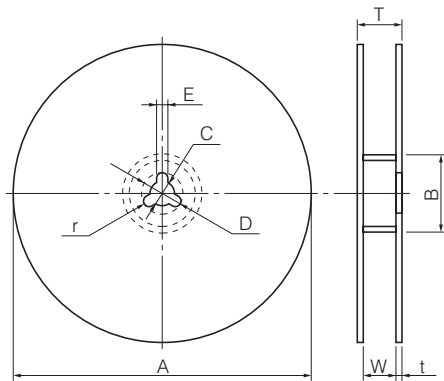

Item	A	B	C	D	E
Rate (mm)	φ380.0±2.0	φ80.0±1.0	φ13.0±0.5	φ21.0±1.0	2.0±0.5

Item	W	T	t	r
Rate (mm)	13.5±1.0	17.5±1.0	-	-

## X-ON Electronics

Largest Supplier of Electrical and Electronic Components

*Click to view similar products for [Tactile Switches](#) category:*

*Click to view products by [Panasonic](#) manufacturer:*

Other Similar products are found below :

[KMR633NG LFG](#) [5GTH92001](#) [5GTH9202242](#) [6426-201-11343](#) [MJ1226](#) [MJTP1109B](#) [MJTP1138EAUTR](#) [MJTP1230BL](#) [MJTPSHW](#)  
[GS6.90F300QP](#) [1-1977223-0](#) [1-1977120-4](#) [ADTSA62NV](#) [ADTSA62RV](#) [ADTSA63KV](#) [ADTSA644NV](#) [ADTSM24NVTR](#) [ADTSMW66NV](#)  
[ADTSMW67RV](#) [ATM533VTR](#) [1571300-3](#) [B3F-3123](#) [B3F-6055A](#) [B3F-B32-01-KIT](#) [1977177-8](#) [1977266-1](#) [2-1977223-4](#) [2-1977223-7](#)  
[ADTS644KV](#) [ADTSA61RV](#) [ADTSA62KV](#) [ADTSA63NV](#) [ADTSA63RV](#) [ADTSA65NV](#) [ADTSM21NSVTR](#) [ADTSM25RVTR](#)  
[ADTSM31RVTR](#) [ADTSM32NVTR](#) [ADTSM61YVTR](#) [ADTSM63SVTR](#) [ADTSM644KVTR](#) [ADTSMW64RV](#) [ADTSMW69NV](#)  
[FSMRA4JHA04](#) [GS4.70F300QP](#) [D38999/20JJ37SA](#) [TL1105B](#) [TL1105J](#) [ATH447K2Q](#) [ATM534VTR](#)