

Common mode Noise Filters

Type: **EXCX4CZ**



Features

- Small and thin (L 0.65 mm×W 0.50 mm×H 0.30 mm)
- High-common mode attenuation at 2.4GHz, Suitable for noise suppression at Wi-Fi band
- Strong multilayer/sintered structure, excellent reflow resistance and high mounting reliability
- Lead, halogen and antimony-free
- RoHS compliant

Recommended Applications

- Smartphones, Tablet PCs and DSC
- Suppresses noise radiation to Wi-Fi Equipment

Explanation of Part Numbers

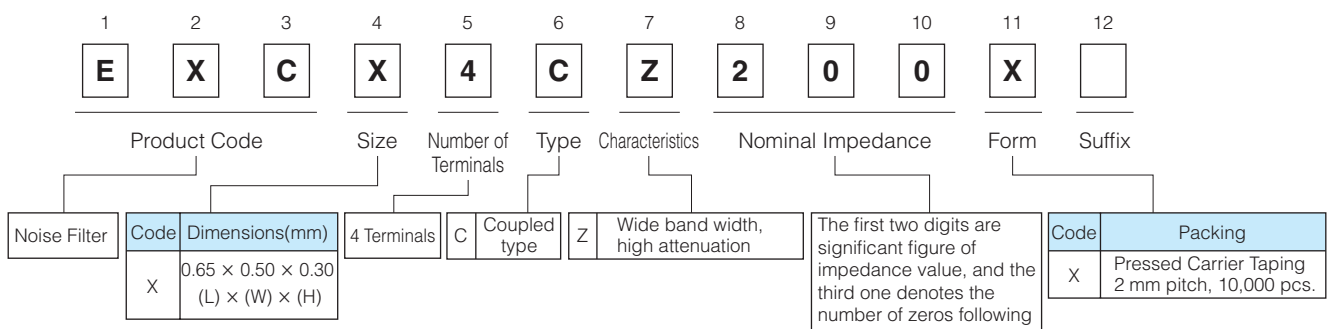

Construction

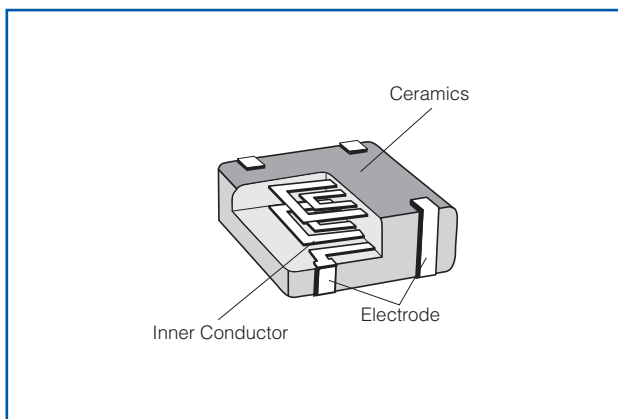

Dimensions in mm (not to scale)

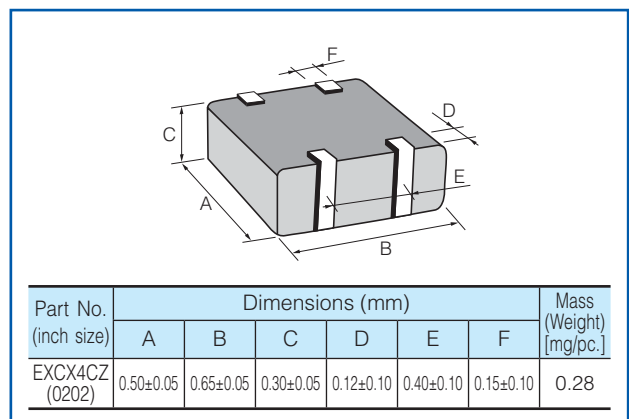

Circuit Configuration (No Polarity)

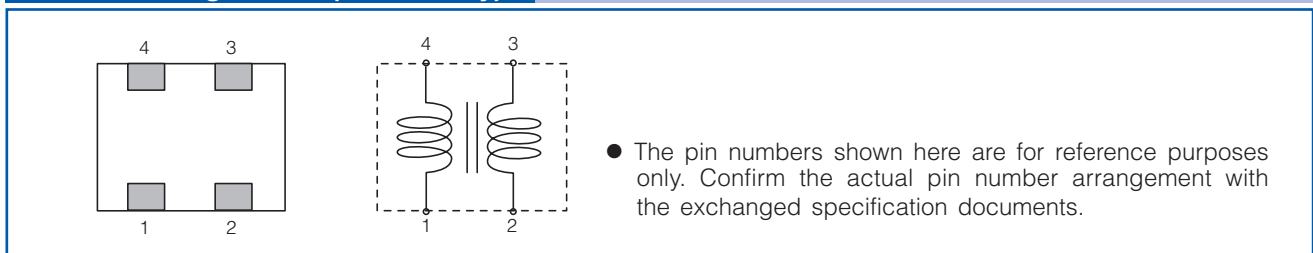

Ratings

Part Number	Impedance (Ω) at 100 MHz	Rated Voltage (V DC)	Rated Current (mA DC)	DC Resistance (Ω)max.
	Common Mode			
EXCX4CZ200X	20 Ω ±30 %	10	100	3.0±30 %

- Category Temperature Range -40 °C to +85 °C

Impedance Characteristics (Typical)

- EXCX4CZ200X

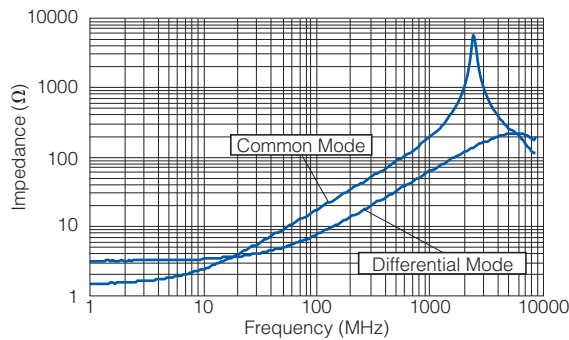

- Measurement Circuit

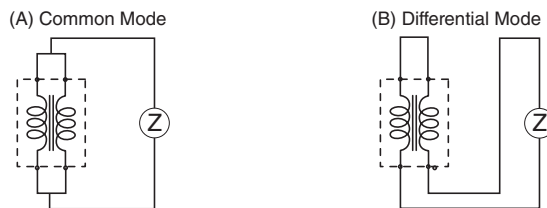

Attenuation Characteristics (Typical)

- EXCX4CZ200X

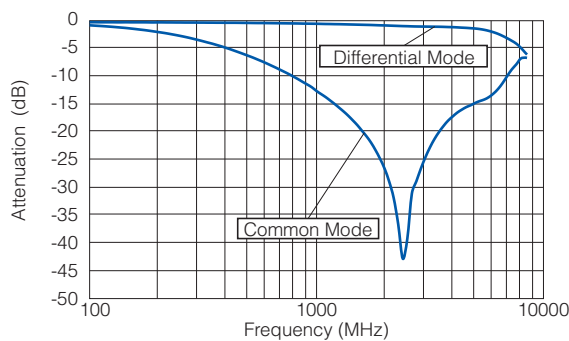

- As for Packaging Methods, Land Pattern, Soldering Conditions and Safety Precautions, Please see Data Files

X-ON Electronics

Largest Supplier of Electrical and Electronic Components

Click to view similar products for [Common Mode Chokes / Filters](#) category:

Click to view products by [Panasonic](#) manufacturer:

Other Similar products are found below :

[74279408](#) [PE-62911NL](#) [PE-64683](#) [ST6118T-R](#) [T8114NLT](#) [RD5122-10-6M0](#) [TCM0806G-350-2P-T](#) [TCM0806G-650-2P-T](#) [IND-0110](#)
[UAL21V07012500](#) [UAL21VR0802000](#) [UAL24VR06500CH](#) [UALSC023000000](#) [UALSC1020JH000](#) [UALSC1520JH000](#)
[UALSU10VR20010](#) [UALSU16VD30030](#) [UALSU16VD40010](#) [UALSU9H0305000](#) [UALSU9HF060300](#) [UALSU9VD070100](#) [36-00037](#)
[5701610000](#) [UALW21HS072450](#) [UALSU9VD070400](#) [UALSU9HF050500](#) [UALSU9H0208000](#) [UALSCF25081300](#) [UAL24VK06450CH](#)
[PLT10HH501100PNB](#) [PLT10HH401100PNB](#) [PLT10HH1026R0PNB](#) [PE-67531](#) [EXC-X4CH120X](#) [TLH10UB 113 0R5](#) [2752041447](#)
[2752045447](#) [CMS3-11-R](#) [7351V](#) [CMF16-153131](#) [744252510](#) [T8116NLT](#) [FE2X10-4-2NL](#) [744253200](#) [744253101](#) [744252220](#) [TX8111NLT](#)
[UAL30VR3500470](#) [CTX01-19077-R](#) [T8003NLT](#)