

Fiber Sensor Guide Book



GENERAL TERMS AND CONDITIONS

Please read this document carefully with respect to our product warranty policy before using our Panasonic Industrial Devices SUNX products ("Products"). If you have any questions or comments regarding do's and don'ts of the Products, please consult your local Panasonic Industrial Devices SUNX authorized dealer for the correct use and application of the Products.

1. PRODUCT MODIFICATION & DISCONTINUANCE:

Panasonic Industrial Devices SUNX expressly reserves the right to modify, including the right to discontinue, any of the Products, prior to their order, from time to time without notice.

2. WARRANTIES:

- (1) Subject to the exclusions stated in 3 (EXCLUSIONS) herein below, Panasonic Industrial Devices SUNX warrants the Products to be free of defects in material and workmanship for a period of one (1) year from the date of shipment under normal usage in environments commonly found in manufacturing industry.
- (2) Any Products found to be defective must be shipped to Panasonic Industrial Devices SUNX with all shipping costs paid by Purchaser or offered to Panasonic Industrial Devices SUNX for inspection and examination. Upon examination by Panasonic Industrial Devices SUNX, Panasonic Industrial Devices SUNX will, at its sole discretion, repair or replace at no charge, or refund the purchase price of, any Products found to be defective.

3. EXCLUSIONS

- (1) This warranty does not apply to defects resulting from any cause:
 - (i) which was due to abuse, misuse, mishandling, improper installation, improper interfacing, or improper repair by Purchaser;
 - (ii) which was due to unauthorized modification by Purchaser, in part or in whole, whether in structure, performance or specification;
 - (iii) which was not discoverable by a person with the state-of-the-art scientific and technical knowledge at the time of manufacture;
 - (iv) which was due to an operation or use by Purchaser outside of the limits of operation or environment specified by Panasonic Industrial Devices SUNX;
 - (v) which was due to Force Majeure; and
 - (vi) which was due to any use or application expressly discouraged by Panasonic Industrial Devices SUNX in 5 (CAUTIONS FOR SAFE USE) hereunder.
- (2) This warranty extends only to the first purchaser for application, and is not transferable to any person or entity which purchased from such purchaser for application.
- (3) The performance data presented in this catalogue is only for guidance and shall not constitute any performance warranty by Panasonic Industrial Devices SUNX.

4. DISCLAIMERS

- (1) Panasonic Industrial Devices SUNX's sole obligation and liability under this warranty is limited to the repair or replacement, or refund of the purchase price, of a defective Product, at Panasonic Industrial Devices SUNX's option.
- (2) THE REPAIR, REPLACEMENT, OR REFUND IS THE EXCLUSIVE REMEDY OF THE PURCHASER, AND ALL OTHER WARRANTIES, EXPRESS OR IMPLIED, INCLUDING, WITHOUT LIMITATION, THE WARRANTIES OF MERCHANTABILITY, FITNESS FOR A PARTICULAR PURPOSE, AND NON-INFRINGEMENT OF PROPRIETARY RIGHTS, ARE HEREBY EXPRESSLY DISCLAIMED. IN NO EVENT SHALL PANASONIC INDUSTRIAL DEVICES SUNX AND ITS AFFILIATED ENTITIES BE LIABLE FOR DAMAGES IN EXCESS OF THE PURCHASE PRICE OF THE PRODUCTS, OR FOR ANY INDIRECT, INCIDENTAL, SPECIAL OR CONSEQUENTIAL DAMAGES OF ANY KIND, OR ANY DAMAGES RESULTING FROM LOSS OF USE, BUSINESS INTERRUPTION, LOSS OF INFORMATION, LOSS OR INACCURACY OF DATA, LOSS OF PROFITS, LOSS OF SAVINGS, THE COST OF PROCUREMENT OF SUBSTITUTED GOODS, SERVICES OR TECHNOLOGIES, OR FOR ANY MATTER ARISING OUT OF OR IN CONNECTION WITH THE USE OR INABILITY TO USE THE PRODUCTS.

5. CAUTIONS FOR SAFE USE

- (1) The applications shown in this catalogue are only suggestions, and it is Purchaser's sole responsibility to ascertain the fitness and suitability of the Products for any particular application, as well as to abide by Purchaser's applicable local laws and regulations, if any.
- (2) Never use the Products NOT rated or designated as "SAFETY SENSOR" in any application involving risk to life or property. When such a use is made by Purchaser, such Purchaser shall indemnify and hold harmless Panasonic Industrial Devices SUNX from any liability or damage whatsoever arising out of or in relation to such use.
- (3) In incorporating the Products to any equipment, facilities or systems, it is highly recommended to employ fail-safe designs, including but not limited to a redundant design, flame propagation prevention design, and malfunction prevention design so as not to cause any risk of bodily injury, fire accident, or social damage due to any failure of such equipment, facilities or systems.
- (4) The Products are each intended for use only in environments commonly found in manufacturing industry, and, unless expressly allowed in this catalogue, specification or otherwise, shall not be used in, or incorporated into, any equipment, facilities or systems, such as those:
 - (a) which are used for the protection of human life or body parts;
 - (b) which are used outdoors or in environments subject to any likelihood of chemical contamination or electromagnetic influence;
 - (c) which are likely to be used beyond the limits of operations or environments specified by Panasonic Industrial Devices SUNX in this catalogue or otherwise;
 - (d) which may cause risk to life or property, such as nuclear energy control equipment, transportation equipment (whether on rail or land, or in air or at sea), and medical equipment;
 - (e) which are operated continuously each day for 24 hours; and
 - (f) which otherwise require a high level of safety performance similar to that required in those equipment, facilities or systems as listed in (a) through (e) above.

6. EXPORT CONTROL LAWS

In some jurisdictions, the Products may be subject to local export laws and regulations. If any diversion or re-export is to be made, Purchaser is advised to abide by such local export laws and regulations, if any, at its own responsibility.

7. PURCHASER'S TRASFER OBLIGATIONS

If Purchaser resell or deliver the Products to a third party, Purchaser must provide such third party with a copy of this document, all specifications, manuals, catalogs, leaflets and written information of any kind provided to Purchaser by Panasonic Industrial Devices SUNX or its authorized local representative from time to time regarding the Products.

INDEX

■ Fiber Selection Guide	Choose by model	2
	Choose by shape/application	3
	How to read Model No.	4
	Earlier model comparison table	6
■ New Product Introduction	Tough Fiber	8
■ Fibers	Super Quality	10
	Threaded Type	12
	Square Head Type	14
	Cylindrical Type	16
	Sleeve	18
	Flat Type	20
	Small Spot	22
	Narrow Beam	24
	Wide Beam	25
	Convergent Reflective Type	26
	Retroreflective Type	27
	Chemical / Oil-resistant	28
	Heat-resistant	30
	Vacuum-resistant	32
Liquid Leak / Liquid Detection	34	
■ Fiber Options		42
■ Semi-custom Fibers		46
■ Fiber Dimensions	Thru-beam Type	48
	Retroreflective Type	55
	Reflective Type	56
	Others	66
■ Amplifiers	FX-500 series Ver.2	70
	FX-100 series	98
■ INDEX		112

Fiber Selection Guide

Choose by model

Thru-beam type

Model No.	Page	
	Sensing range Specifications	Dimensions
FT-140	P.12	P.48
FT-30	P.11	
FT-31	P.12	
FT-31S	P.19	
FT-31W	P.12	
FT-40	P.11	
FT-42	P.12	
FT-42S	P.19	
FT-42W	P.12	
FT-43		
FT-45X	P.25	
FT-A11		
FT-A11W		
FT-A32		
FT-A32W		
FT-AL05	P.49	
FT-E13		
FT-E23	P.16/P.19	
FT-F93	P.35	
FT-H13-FM2	P.50	
FT-H20-J20-S		
FT-H20-J30-S		
FT-H20-J50-S		
FT-H20-M1		
FT-H20-VJ50-S		
FT-H20-VJ80-S		
FT-H20W-M1		
FT-H30-M1V-S		P.32
FT-H35-M2		P.30
FT-H35-M2S6	P.51	
FT-HL80Y		P.29
FT-KS40		P.24
FT-KV26		
FT-KV40		
FT-KV40W		
FT-L80Y		P.29
FT-R31		P.15
FT-R40		P.12
FT-R41W		P.15
FT-R42W		
FT-R43		
FT-R44Y	P.15/P.29	
FT-R60Y		
FT-S11	P.16	
FT-S20	P.11	
FT-S21	P.52	
FT-S21W		
FT-S30		P.11
FT-S31W		P.16
FT-S32	P.19	
FT-V23		
FT-V24W		
FT-V25		
FT-V30		
FT-V40	P.16	
FT-V80Y	P.29	
FT-Z20HBW	P.20	
FT-Z20W		

Retroreflective type

Model No.	Page	
	Sensing range Specifications	Dimensions
FR-KZ22E	P.24/P.27	P.55
FR-KZ50E		
FR-KZ50H		
FR-Z50HW		

Model No.	Page	
	Sensing range Specifications	Dimensions
FT-Z30	P.20	P.53
FT-Z30E		
FT-Z30EW		
FT-Z30H		
FT-Z30HW		
FT-Z30W		
FT-Z40HBW		
FT-Z40W		
FT-Z802Y		P.29

Reflective type

Model No.	Page	
	Sensing range Specifications	Dimensions
FD-30	P.11	P.56
FD-31	P.13	
FD-31W		
FD-32G		
FD-32GX		
FD-40	P.11	
FD-41	P.13	
FD-41S	P.19	
FD-41SW	P.13	
FD-41W		
FD-42G	P.13/P.23	P.57
FD-42GW		
FD-60	P.11	
FD-61	P.13	
FD-61G	P.19	
FD-61S	P.13	
FD-61W	P.13	
FD-62	P.13	
FD-64X	P.25	
FD-A16	P.17/P.19	
FD-AL11		
FD-E13		
FD-E23		
FD-EG30	P.13/P.23	
FD-EG30S	P.19	
FD-EG31	P.13/P.23	
FD-F4	P.35	P.59
FD-F41		
FD-F41Y		
FD-F71		
FD-F8Y		
FD-FA93		
FD-H13-FM2		
FD-H18-L31	P.31	P.60
FD-H20-21		
FD-H20-M1		
FD-H25-L43		
FD-H25-L45		

Model No.	Page	
	Sensing range Specifications	Dimensions
FD-H30-KZ1V-S	P.32	P.61
FD-H30-L32	P.31	
FD-H30-L32V-S	P.32	
FD-H35-20S	P.31	P.62
FD-H35-M2		
FD-H35-M2S6	P.35	
FD-HF40Y	P.26	
FD-L10		
FD-L11		
FD-L12W		
FD-L20H		
FD-L21		
FD-L21W		
FD-L22A		
FD-L23		
FD-L30A		
FD-L31A	P.15/P.23	P.63
FD-L32H		
FD-R31G		
FD-R32EG		
FD-R33EG		
FD-R34EG		
FD-R41	P.15	
FD-R60	P.13	
FD-R61Y	P.15/P.29	
FD-S21	P.17	
FD-S30	P.11	
FD-S31	P.17	P.64
FD-S32		
FD-S32W		
FD-S33GW		
FD-S60Y		
FD-V30	P.19	
FD-V30W		
FD-V50		
FD-Z20HBW	P.21	P.65
FD-Z20W		
FD-Z40HBW		
FD-Z40W		
FD-Z50HW		

New product introduction

Tough Fiber

Fiber Selection Guide

Model

Choose by shape/application

How to read Model No

Earlier models comparison table

Fibers

Super Quality

Threaded Type

Square Head Type

Cylindrical Type

Sleeve

Flat Type

Small Spot

Narrow Beam

Wide Beam

Convergent Reflective Type

Retroreflective Type

Chemical / Oil-resistant

Heat-resistant

Vacuum-resistant

Liquid Leak / Liquid Detection

Fiber Options

Semi-custom fibers

Fiber Dimensions

Thru-beam Type

Retroreflective Type

Reflective Type

Others

Amplifiers

FX-500 series

FX-100 series

INDEX

Fiber Selection Guide

Choose by shape

Threaded Type

- Standard type which is mounted using nuts.



P.12

Square Head Type

- Installed cleanly on the side of a conveyor belt.



P.14

Cylindrical Type

- Has a slender shape that is mounted using set screws.



P.16

Sleeve

- Suitable for sensing in narrow locations and sensing minute objects.



P.18

Flat Type

- Thin and rectangular shape. Installed directly in narrow locations with screws.



P.20

Choose by beam shape

Small Spot

- Senses minute objects using a spot lens.



P.22

Narrow Beam

- Not easily affected by surrounding obstacles.

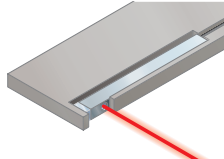

P.24

Wide Beam

- Senses in the beam band without missing a work.

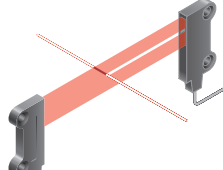

P.25

Convergent Reflective Type

- Senses in the limited range only.

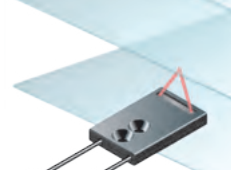

P.26

Retroreflective Type

- Ideal for sensing transparent objects



P.27

Choose by quality

Super Quality

- The variance of beam intensity and beam axis is extremely small.



P.10

Chemical / Oil-resistant

- Various kinds of liquids can be detected due to the fluorine contained resin case



P.28

Heat-resistant

- Withstands at -60 °C -76 °F to 350 °C 662 °F



P.30

Vacuum-resistant

- Usable in high-temperatures of 300 °C 572 °F and vacuum



P.32

Liquid Leak / Liquid Detection

- Corresponds to various liquid events.

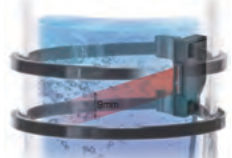

P.34

Choose by environment / performance

Fiber sensor amplifiers guidance

Digital fiber sensor FX-500 series Ver. 2

- At the industry's leading edge



P.70

Digital fiber sensor FX-100 series

- Super functionality, yet, economical price



P.98

New product introduction
Tough Fiber

Fiber Selection Guide
Model
Choose by shape/application
How to read Model No.
Earlier models comparison table

Fibers
Super Quality
Threaded Type
Square Head Type
Cylindrical Type
Sleeve
Flat Type
Small Spot
Narrow Beam
Wide Beam
Convergent Reflective Type
Retroreflective Type
Chemical / Oil-resistant
Heat-resistant
Vacuum-resistant
Liquid Leak / Liquid Detection

Fiber Options

Semi-custom fibers

Fiber Dimensions
Thru-beam Type
Retroreflective Type
Reflective Type

Others

Amplifiers
FX-500 series
FX-100 series

INDEX

Fiber Selection Guide

How to read Model No.

Applies to the fiber in (P.10~P.35)

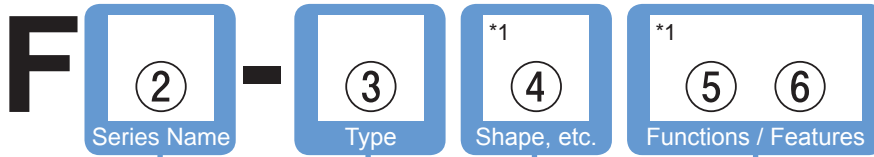

*1: Excluding liquid leak / liquid detection fiber

②

Symbol	Details
T	Thru-beam type
D	Reflective type
R	Retroreflective type

⑤

Symbol	Details
None	General-purpose
G	Coaxial reflective
S	Sleeve
H	Top sensing *
E	Side sensing *
HB	Top sensing + Bent *
A	Alignment

*③ is for Flat type (Z and KZ) only

⑥

Symbol	Details
None	General-purpose
W	Sharp bending
X	Stainless-jacketed
Y	Chemical-resistant

③		④	
Symbol	Details	Lead No.	Details
None	Treaded type	3	M3
		4	M4
		6	M6
		14	M14
R	Elbow or square head	4	M4
		6	M6
S	Cylindrical type	1	ø1 mm
		2	ø1.5 mm
		3	ø2.5 or ø3 mm
KS	Narrow beam	4	ø3.7 mm
		2	ø2 mm
V	Side-view	3	ø2.5 or ø3 mm
		4	ø4 mm
		5	ø5 mm
KV	Narrow beam / Side-view	4	ø4 mm
		2	1.5 x 2 mm
E	Ultra small diameter	1	Fiber ø0.125 mm
		2	Fiber ø0.25 mm
EG	Coaxial	3	M3
Z	Flat type	2	Thickness 2 mm
		3	Thickness 3 mm
		4	Thickness 3.5 mm
		5	Thickness 5.2 mm
		2	Thickness 2.2 mm
KZ	Narrow beam	5	Thickness 5.2 mm
		3	Sensing width 32 mm
A	Wide beam	1	Sensing width 10 to 19 mm
		1	Sensing width 11.1 mm
AL	Array	0	Sensing width 5.5 mm
		1	Sensing range 0 to 10 mm (STD)
		2	Sensing range 11 to 30 mm (STD)
L	Convergent reflective type	3	Sensing range 31mm or more (STD)
		9	Mountable on pipe
		7	Liquid leak
F	Liquid leak / Liquid detection	9	Mountable on pipe
		7	Liquid leak

MEMO

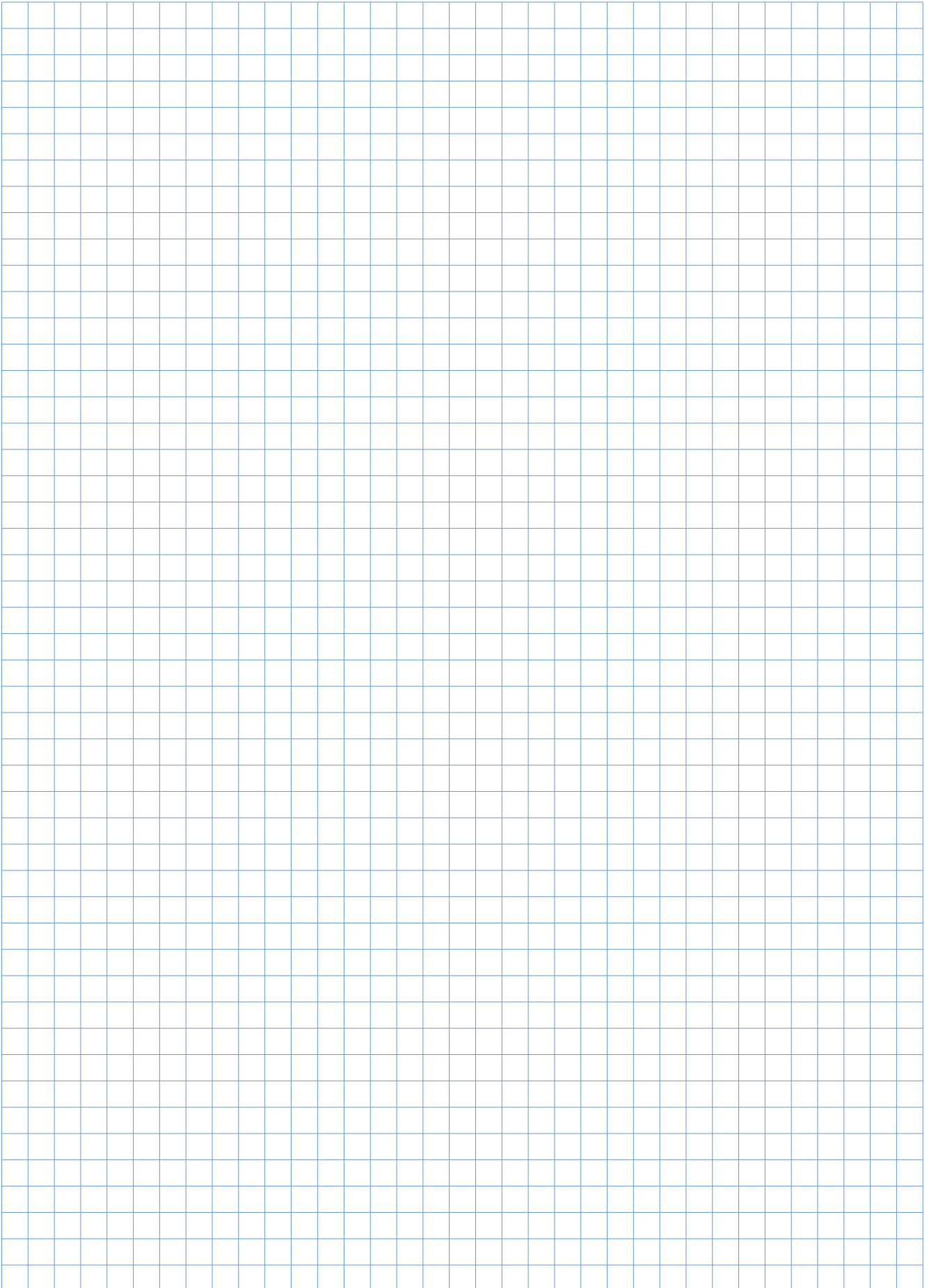

Fiber Selection Guide

Earlier Models Comparison Table (The specification of new fiber may be changed from that of old one. Please confirm the specification before use.)

Thru-beam type

Old fiber Model No.	New fiber Model No.	Page	
		Sensing range Specifications	Dimensions
FT-A30	FT-A32	P.25	P.49
FT-A8	FT-A11		
FT-AFM2	FT-AL05		
FT-AFM2E			
FT-B8	FT-43	P.12	P.48
FT-E12	FT-E13	P.16/P.19	P.49
FT-E22	FT-E23		
FT-F902	FT-F93	P.35	
FT-FM10L	FT-140	P.12	P.48
FT-FM2	FT-42		
FT-FM2S	FT-42S	P.19	
FT-FM2S4			
FT-K8	FT-KS40	P.24	P.51
FT-KV1	FT-KV26		
FT-KV8	FT-KV40		
FT-NFM2	FT-31	P.12	
FT-NFM2S	FT-31S	P.19	P.48
FT-NFM2S4			
FT-P2	FT-S21	P.16	P.52
FT-P40	FT-31	P.12	P.48
FT-P60	FT-42		
FT-P80			
FT-P81X	FT-45X		P.49
FT-PS1	FT-S11	P.16	P.52
FT-R80	FT-R40	P.12	P.51
FT-SFM2	FT-S32	P.16	P.52
FT-SFM2L			
FT-SFM2SV2	FT-V30	P.19	P.53
FT-SNFM2	FT-S21	P.16	P.52
FT-T80	FT-42	P.12	P.48
FT-V10	FT-V40	P.16	P.53
FT-V22	FT-V23	P.19	P.52
FT-V41	FT-V25		P.53
FT-W4	FT-31	P.12	P.48
	FT-31W		
FT-W8	FT-42		
	FT-42W		
FT-WA30	FT-A32	P.25	P.49
	FT-A32W		
FT-WA8	FT-A11		
	FT-A11W		

Old fiber Model No.	New fiber Model No.	Page	
		Sensing range Specifications	Dimensions
FT-WKV8	FT-KV40	P.24	P.51
	FT-KV40W		
FT-WR80	FT-R41W	P.15	
FT-WR80L	FT-R42W		
FT-WS3	FT-S31W	P.16	P.52
FT-WS4	FT-S21		
	FT-S21W		
FT-WS8	FT-S31W	P.19	P.53
FT-WS8L	FT-S32		
FT-WV42	FT-V25	P.20	P.54
	FT-V24W		
FT-WZ4	FT-Z20W	P.20	P.53
FT-WZ4HB	FT-Z20HBW		
FT-WZ7	FT-Z40W	P.20	P.54
FT-WZ7HB	FT-Z40HBW		
FT-WZ8	FT-Z30	P.20	P.53
	FT-Z30W		
FT-WZ8E	FT-Z30E	P.20	P.53
	FT-Z30EW		
FT-WZ8H	FT-Z30H	P.20	P.54
	FT-Z30HW		
FT-Z8	FT-Z30		P.53
FT-Z8E	FT-Z30E		P.54
FT-Z8H	FT-Z30H	P.11	P.52
————	FT-30		
————	FT-40		
————	FT-S20	P.15	P.51
————	FT-S30		
————	FT-R31		
————	FT-R43		

Retroreflective type

Old fiber Model No.	New fiber Model No.	Page	
		Sensing range Specifications	Dimensions
FR-KV1	FR-KZ22E	P.24/P.27	P.55
FR-KZ21	FR-KZ50H		
FR-KZ21E	FR-KZ50E		
FR-WKZ11	FR-Z50HW		

New product introduction

Tough Fiber

Fiber Selection Guide

Model

Choose by shape/application

How to read Model No

Earlier models comparison table

Fibers

Super Quality

Threaded Type

Square Head Type

Cylindrical Type

Sleeve

Flat Type

Small Spot

Narrow Beam

Wide Beam

Convergent Reflective Type

Retroreflective Type

Chemical / Oil-resistant

Heat-resistant

Vacuum-resistant

Liquid Leak / Liquid Detection

Fiber Options

Semi-custom fibers

Fiber Dimensions

Thru-beam Type

Retroreflective Type

Reflective Type

Others

Amplifiers

FX-500 series

FX-100 series

INDEX

Fiber Selection Guide

Reflective type

Old fiber Model No.	New fiber Model No.	Page	
		Sensing range Specifications	Dimensions
FD-A15	FD-A16	P.25	P.58
FD-AFM2	FD-AL11		
FD-AFM2E			
FD-B8	FD-62	P.13	P.57
FD-E12	FD-E13	P.17/P.19	P.58
FD-E22	FD-E23		
FD-EG1	FD-EG30	P.13/P.23	P.59
FD-EG2	FD-EG31		
FD-EG3			
FD-EN500S1	FD-EG30S	P.19	P.59
FD-ENM1S1			
FD-F705	FD-F71	P.35	P.57
FD-FA90	FD-FA93		
FD-FM2	FD-61	P.13	P.57
	FD-61G		
FD-FM2S	FD-61S	P.19	P.56
FD-FM2S4			
FD-G4	FD-42G	P.13/P.23	P.62
FD-G6	FD-32G		
FD-G6X	FD-32GX		
FD-L4	FD-L20H	P.26	P.62
FD-L41	FD-L21		
FD-L43	FD-L22A		
FD-L44	FD-L11		
FD-L44S	FD-L10		
FD-L45	FD-L30A		
FD-L45A	FD-L31A		
FD-L46	FD-L32H		
FD-L47	FD-L23		
FD-L47	FD-L23		
FD-NFM2	FD-41	P.13	P.56
FD-NFM2S	FD-41S	P.19	
FD-NFM2S4			
FD-P2	FD-S21	P.17	P.63
FD-P40	FD-31	P.13	P.56
FD-P50	FD-S32	P.17	P.64
FD-P60	FD-41	P.13	P.56
FD-P80	FD-61		P.57
FD-P81X	FD-64X		P.58
FD-R80	FD-R60		P.63
FD-S80	FD-S32	P.17	P.64

Old fiber Model No.	New fiber Model No.	Page	
		Sensing range Specifications	Dimensions
FD-SFM2SV2	FD-V50	P.19	P.65
FD-SNFM2	FD-S31	P.17	P.64
FD-T40	FD-31	P.13	P.56
FD-T80	FD-61		P.57
	FD-41		P.56
FD-V41	FD-V30	P.19	P.64
FD-W44	FD-41S		P.56
	FD-41SW		
FD-W8	FD-61	P.13	P.57
	FD-61W		
FD-WG4	FD-42G	P.13/P.23	P.65
	FD-42GW		
FD-WKZ1	FD-Z50HW	P.24	P.65
FD-WL41	FD-L21	P.26	P.62
	FD-L21W		
FD-WL48	FD-L12W	P.17	P.64
FD-WS8	FD-S32		
	FD-S32W		
FD-WSG4	FD-S33GW	P.13	P.56
FD-WT4	FD-31		
	FD-31W		
FD-WT8	FD-41	P.19	P.64
	FD-41W		
FD-WV42	FD-V30	P.19	P.64
	FD-V30W		
FD-WZ4	FD-Z20W	P.21	P.65
FD-WZ4HB	FD-Z20HBW		
FD-WZ7	FD-Z40W		
FD-WZ7HB	FD-Z40HBW		
—————	FD-30	P.11	P.56
—————	FD-40		P.57
—————	FD-60		
—————	FD-S30		P.64
—————	FD-R31G	P.15/P.23	P.63
—————	FD-R32EG		
—————	FD-R33EG		
—————	FD-R34EG	P.15	P.63
—————	FD-R41		

New product introduction

Tough Fiber

Fiber Selection Guide

Model

Choose by shape/application

How to read Model No.

Earlier models comparison table

Fibers

Super Quality

Threaded Type

Square Head Type

Cylindrical Type

Sleeve

Flat Type

Small Spot

Narrow Beam

Wide Beam

Convergent Reflective Type

Retroreflective Type

Chemical / Oil-resistant

Heat-resistant

Vacuum-resistant

Liquid Leak / Liquid Detection

Fiber Options

Semi-custom fibers

Fiber Dimensions

Thru-beam Type

Retroreflective Type

Reflective Type

Others

Amplifiers

FX-500 series

FX-100 series

INDEX

Tough Fiber

Unbreakable ! More flexible ! ECO !
Conventional 3 types rolled into 1 !!



Flexible fiber
Flexible durability
1 million times

Sharp bending fiber
Bending radius
R2~R1 mm

General purpose fiber
Bending radius
R25 mm

Tough Fiber
Unbreakable
Flexible durability **10 million times** (Typical)
Bending conditions Bending radius: R10 mm
Reciprocating bending: 180°
More flexible
Bending radius **R2~R4 mm**

ECO
Stainless steel fittings are used for the fiber head of all models.

- Clearly conforms to RoHS
- Can be used for secondary battery
- Improved mounting strength

New tough fibers exceed normal optic fibers!

Tough fibers can be used on moving parts, can be bent with precision, and offer high quality for all purposes. They go beyond what was commonly thought to be possible.

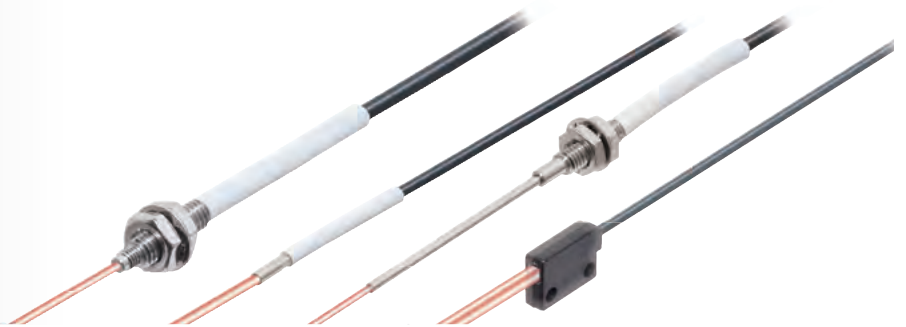

Unbreakable

Bending conditions

Bending radius: R10 mm **R0.394 in**,
Reciprocating bending: 180°

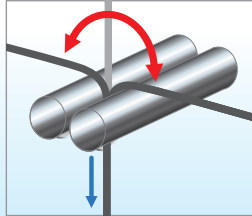

Flexible durability

10 million times
(Typical)

ECO

Stainless steel fittings are used for the fiber head of all models.

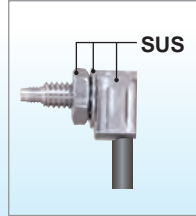

- Clearly conforms to RoHS
- Can be used for secondary batteries
- Improved tightening torque

More flexible

R2 to R4 mm **R0.079 to R0.157 in**

Example: FT-31



Example: FT-42

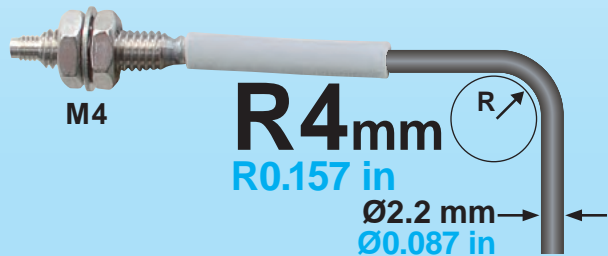

Reduced the time in selecting fiber and in registering part numbers

For Designers

High-quality

- High-quality in whichever tough fiber you choose!
- Easy selection!
- Reduces risk of breaking and bending during installation!

For Buyers

Low Price

- Cost savings!
- Reduced registration of part numbers!
- Reduced maintenance time in keeping stocks and replacement!

Reduced variation in detection

Beams at the fiber aperture are uniform, leading to stable sensing.

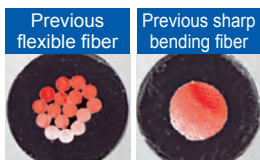

Generally flexible fibers and sharp bending fibers are composed of multiple fiber cores, often resulting in large variations in light intensity.

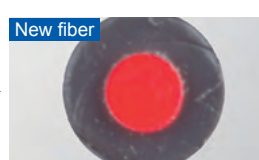

The new standard fiber is composed of a single fiber core, achieving uniform light intensity.

- Uniform and highly accurate sensing
- Stable sensing even if the fiber is bent

New product introduction
Tough Fiber

Fiber Selection Guide
Model
Choose by shape/application
How to read Model No.
Earlier models comparison table

Fibers
Super Quality
Threaded Type
Square Head Type
Cylindrical Type
Sleeve
Flat Type
Small Spot
Narrow Beam
Wide Beam
Convergent Reflective Type
Retroreflective Type
Chemical / Oil-resistant
Heat-resistant
Vacuum-resistant
Liquid Leak / Liquid Detection

Fiber Options

Semi-custom fibers

Fiber Dimensions

Thru-beam Type

Retroreflective Type

Reflective Type

Others

Amplifiers

FX-500 series

FX-100 series

INDEX

New product introduction
Tough Fiber

Fiber Selection Guide
Model
Choose by shape/application
How to read Model No
Earlier models comparison table

Fibers
Super Quality
Threaded Type
Square Head Type
Cylindrical Type
Sleeve
Flat Type
Small Spot
Narrow Beam
Wide Beam
Convergent Reflective Type
Retroreflective Type
Chemical / Oil-resistant
Heat-resistant
Vacuum-resistant
Liquid Leak / Liquid Detection

Fiber Options
Semi-custom fibers

Fiber Dimensions
Thru-beam Type
Retroreflective Type
Reflective Type
Others

Amplifiers
FX-500 series
FX-100 series

INDEX

Super Quality

- It is a fiber with superior light intensity stability and simple digital management when combined with the **FX-500** series amplifier.
- It offers stable sensing with an extremely small beam axis curvature and gap.

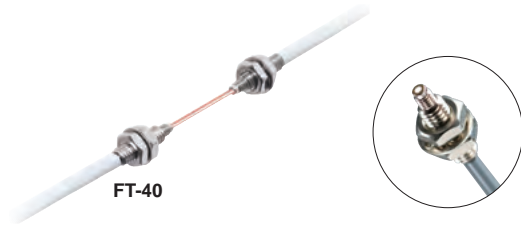

Digital management is simple due to small differences in body.

When connected with the **FX-500** series amplifiers, it has up to 4 times improved stability of incident light intensity compared with traditional fibers. Management is simple even when replacing amplifiers because the digital display shows the approximate value.

Super quality fiber + **FX-500 series**

"Stabilized incident light intensities" even in multiple units

Emitter intensity is also stable due to few curvatures and gaps in the beam axis.

Stable emission amount within ±10 %

Variation in emission amount of the fiber core is controlled down to less than ±10 %, achieving a stable detection.

- Beam axis deviation: Thru-beam type within ±2°, Reflective type within ±3°
- Beam axis centering precision: within ±150 μm

Expanded temperature range

Ambient temperature [-40 to +70 °C -40 to +158 °F in previous model]

-55 to +80 °C 1.2 times more than previous model
-67 to +176 °F

ø2.2 mm ø0.087 in standard fiber

New material

Single core standard fiber with high flexibility

Previous

In general, high-flexibility types adopt a multi-fiber core, which may result in large variation in light emission.

More flexible! **R4**

Bending radius [Previous model is R25 mm R0.984 in]

R4 mm 1/6 of that of previous model
R0.157 in



Integrated high-precision plug

The centering precision of the fiber core attached to the inserting plug is doubled. As the insertion precision is increased, the variation among units can be greatly suppressed.



- Centering precision: within ±40 μm

More bendable!

Bending durability [Previous model is 1,000 times]

10 million times 10,000 times more than previous model

* Bending conditions
 Bending radius: R10 mm **R0.394 in**,
 Reciprocating bending 180°

LIST OF FIBERS

Thru-beam type (one pair set)

Type	Shape of fiber head (mm)	Model No.	Bending radius (mm)	Fiber cable length	Sensing range (mm in)			Beam axis dia. (mm)	Beam axis position/Inclination of beam axis	Optical transmission loss	Protection	Ambient temp.	Dimensions
					FX-500 series	U-LG LONG FAST H-SP	FX-101 (Upper value) FX-102 (Lower value)						
Threaded	M3	Tough FT-30	R2 Bending durability	2 m	STD 400 15.748	810 31.890 650 25.91 210 8.268 75 2.953	135 5.315 400 15.748	∅0.5	150 μm ±2°	±10 %	IP67	-55 to +80 °C	P.48
	M4	Tough FT-40	R4 Bending durability		STD 1,200 47.244 HYPR (Note) 3,600 141.732	2,200 86.614 1,700 66.929 530 20.866 190 7.480	320 12.598 870 34.252	∅1					
Cylindrical	∅1.5	Tough FT-S20	R2 Bending durability		STD 400 15.748 HYPR 1,350 53.150	810 31.890 650 25.91 210 8.268 75 2.953	135 5.315 400 15.748	∅0.5					
	∅3	Tough FT-S30	R4 Bending durability		STD 1,200 47.244 HYPR (Note) 3,600 141.732	2,200 86.614 1,700 66.929 530 20.866 190 7.480	320 12.598 870 34.252	∅1					

Note: The fiber cable length practically limits the sensing range.

Reflective type

Type	Shape of fiber head (mm)	Model No.	Bending radius (mm)	Fiber cable length	Sensing range (mm in) (Note)			Beam axis position/Inclination of beam axis	Optical transmission loss	Protection	Ambient temp.	Dimensions					
					FX-500 series	U-LG LONG FAST H-SP	FX-101 (Upper value) FX-102 (Lower value)										
Threaded	M3	Tough FD-30	R2 Bending durability	2 m	STD 160 6.299 HYPR 600 23.622	330 12.992 250 9.843 80 3.150 25 0.984	45 1.772 155 6.102	150 μm ±3°	±10 %	IP67	-55 to +80 °C	P.56					
	M4	Tough FD-40			STD 520 20.472 HYPR 1,550 61.024	900 35.433 740 29.134 260 10.236 90 3.543	140 5.512 420 16.535						P.57				
	M6	Tough FD-60	R4 Bending durability		STD 160 6.299 HYPR 600 23.622	330 12.992 250 9.843 80 3.150 25 0.984	45 1.772 155 6.102					P.64					
Cylindrical	∅3	Tough FD-S30															

Note: The sensing range is specified for white non-glossy paper.

Tough : Refers to a fiber which possesses both unbreakable (bending radius: R10 mm R0.394 in, reciprocating bending: 180°) and more flexible (bending radius: R4 mm R0.157 in or less) features.

Threaded Type

- It is a standard fiber which is mounted using nuts. It has reasonable pricing while drastically improving flexing performance.
- With the lens installable type, long distance sensing and microscopic object sensing is possible by installing a lens.
- A protective tube and a sturdy stainless jacket type that prevents disconnection are also prepared.

Stainless steel fittings are used for the fiber head of all models.

- Clearly conforms to RoHS
- Can be used for secondary battery
- Improved mounting strength

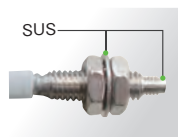

* Some models not included (FT-140)

Coaxial type FD-□G□ in which high-precision positioning can be achieved.

It is a coaxial fiber that encloses the circumference of the emitter fiber at the center with the receiver fiber. This is suitable for high-precision positioning. It can perform sensing without affecting the approach direction of the work.



Supports spot lenses and zoom lenses!

LIST OF FIBERS

Thru-beam type (one pair set)

Type	Shape of fiber head (mm)	Model No.	Bending radius (mm)	Fiber cable length (m)	Sensing range (mm in) (Note 1)			Beam axis dia. (mm)	Beam axis position/Inclination of beam axis	Protection	Ambient temp.	Dimensions
					FX-500 series	U-LG LONG FAST H-SP	FX-101 (Upper value) FX-102 (Lower value)					
Threaded		Tough FT-31	R2	Free-cut	STD 315 12.402	770 30.315	130 5.118	ø0.5	±2°	IP67	-55 to +80 °C	P.48
		HYPR 1,350 53.150	550 21.654		340 13.386							
		FT-31W	R1	STD 260 10.236	590 23.228	80 3.150	150 μm /±3°	-40 to +60 °C				
		HYPR 990 38.976	440 17.323	240 9.449								
		Lens mountable	FT-43	R4	2 m	STD 1,400 55.118	2,800 110.236	350 13.780	ø1.5	±2°	-55 to +80 °C	
		HYPR (Note 2) 3,600 141.732	2,100 82.677	970 38.189								
		Tough FT-42	R4	STD 1,130 44.488		2,050 80.709	300 11.811					
		HYPR (Note 2) 3,600 141.732	1,600 62.992	800 31.496								
		STD 800 31.496	1,900 74.803	260 10.236								
		HYPR 3,300 129.921	1,400 55.118	720 28.346								
	FT-42W	R1	STD 1,200 47.244	1,600 62.992 (Note 2)	340 13.386	150 μm /±3°	-40 to +60 °C					
	HYPR (Note 2) 1,600 62.992	1,600 62.992 (Note 2)	920 36.220									
	Lens mountable, Stainless-jacketed	FT-45X	R4	1 m	STD 930 36.614	1,750 68.898	270 10.630	ø1	±2°	-55 to +80 °C		
	HYPR (Note 2) 3,600 141.732	1,500 59.055	740 29.134									
	Lens mountable	Tough FT-R40	R4	2 m	STD (Note 2) 19,600 771.654	19,600 771.654 (Note 2)	14,000 551.181	ø10	—	-40 to +70 °C		
	HYPR (Note 2) 19,600 771.654	19,600 771.654 (Note 2)	19,600 771.654 (Note 2)									
	With expansion lens	Tough FT-140	R4	10 m	STD (Note 2) 19,600 771.654	19,600 771.654 (Note 2)	14,000 551.181 (Note 2)					

Notes: 1) Note that the sensing range of the free-cut type fiber may be reduced by 20 % max. depending upon how the fiber is cut.
2) The fiber cable length practically limits the sensing range.

Tough : Refers to a fiber which possesses both unbreakable (bending radius: R10 mm R0.394 in, reciprocating bending: 180°) and more flexible (bending radius: R4 mm R0.157 in or less) features.



FT-42

- <Thru-beam type> FT-31/31W/43/42/42W FT-45X/R40
- <Reflective type> FD-31/41/62/61/R60

More user-friendly, high quality fiber

Improved centering accuracy

The beam axis deviation of each unit is kept within ±3° and the beam axis centering accuracy is kept within ±150 μm.

(Within ±5° and ±90 μm for ultra small diameter fibers)

- Makes beam axis adjustment easier
- Improves mounting hole machining accuracy
- Improves sensing accuracy



Improved specularity

High precision polishing is accomplished by using the PCTC polishing technique.

The specularity of the end face of the fiber is 5 times greater.

- Light intensity is increased, enabling stable sensing.

Application

Detecting a presence of a workpiece

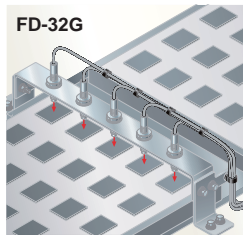

FIBER OPTIONS

Lens
(For thru-beam type fiber)
► P.42

Lens
(For reflective type fiber)
► P.43

Protective tube ► P.45

- FTP-□
- FDP-□

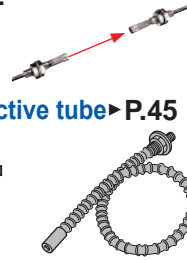

LIST OF FIBERS

Reflective type

Type	Shape of fiber head (mm)	Model No.	Bending radius (mm)	Fiber cable length Free-cut	Sensing range (mm in) (Note 1, 2)			Beam axis position/ Inclination of beam axis	Protection	Ambient temp.	Dimensions		
					FX-500 series	U-LG LONG FAST H-SP	FX-101 (Upper value) FX-102 (Lower value)						
M3		Tough FD-31	R2 Bending durability	2 m	STD 125 4.921	290 11.417	35 1.378	150 μm /±3°	IP67	-55 to +80 °C	P.56		
					HYPR 515 20.276	220 8.661	140 5.512						
		FD-31W	R1	2 m	STD 80 3.150	180 7.087	15 0.591	—	—	-40 to +60 °C			
					HYPR 330 12.992	140 5.512	60 2.362						
		Tough FD-32G	R2 Bending durability	1 m	STD 200 7.874	380 14.961	70 2.756	—	—	-55 to +80 °C			
					HYPR 650 25.591	270 10.630	190 7.480						
		FD-32GX	R2	1 m (Note 3)	STD 200 7.874	410 16.142	75 2.953	—	—	—			
					HYPR 630 24.803	360 14.173	210 8.268						
		FD-EG30	R4	500 mm	STD 48 1.890	130 5.118	20 0.787	—	—	-40 to +70 °C			
					HYPR 170 6.693	110 4.331	70 2.756						
	FD-EG31	R4	500 mm	STD 20 0.787	45 1.772	7 0.276	—	—	-20 to +60 °C				
				HYPR 85 3.346	35 1.378	25 0.984							
Threaded		Tough FD-41	R2 Bending durability	2 m	STD 125 4.921	290 11.417	35 1.378	150 μm /±3°	IP67	-55 to +80 °C	P.56		
					HYPR 515 20.276	220 8.661	140 5.512						
		FD-41W	R1	2 m	STD 270 10.630	630 24.803	80 3.150	—	—	-40 to +60 °C			
					HYPR 900 35.433	430 16.929	230 9.055						
		Tough FD-42G	R2 Bending durability	2 m	STD 200 7.874	380 14.961	70 2.756	—	—	-55 to +80 °C			
					HYPR 650 25.591	270 10.630	190 7.480						
		FD-42GW	R1	2 m	STD 150 5.906	340 13.386	45 1.772	—	—	-40 to +60 °C			
					HYPR 670 26.378	280 11.024	140 5.512						
	M6		FD-62	R4 Bending durability	2 m	STD 520 20.472	1,000 39.370	170 6.693	150 μm /±3°	IP67		-55 to +80 °C	P.57
						HYPR 1,500 59.055	940 37.008	450 17.717					
		Tough FD-61	R4 Bending durability	2 m	STD 450 17.717	840 33.071	120 4.724	—	—	-40 to +60 °C			
					HYPR 1,400 55.118	670 26.378	410 16.142						
		FD-61W	R1	2 m	STD 270 10.630	630 24.803	80 3.150	—	—	-40 to +60 °C			
	HYPR 900 35.433				430 16.929	230 9.055							
	Tough FD-61G	R4 Bending durability	2 m	STD 420 16.535	800 31.496	120 4.724	—	—	-55 to +80 °C				
	FD-64X	R4	1 m	STD 280 11.024	500 19.685	75 2.953	—	—	-55 to +80 °C				
				HYPR 670 26.378	410 16.142	220 8.661							
Elbow		Tough FD-R60	R4 Bending durability	2 m	STD 290 11.417	600 23.622	110 4.331	150 μm /±3°	IP67	-55 to +80 °C	P.63		
					HYPR 1,100 43.307	550 21.654	240 9.449						

- Notes: 1) Note that the sensing range of the free-cut type fiber may be reduced by 20% max. depending upon how the fiber is cut.
 2) The sensing range is specified for white non-glossy paper.
 3) The allowable cutting range is 700 mm 27.559 in from the end that the amplifier inserted.

Tough : Refers to a fiber which possesses both unbreakable (bending radius: R10 mm R0.394 in, reciprocating bending: 180°) and more flexible (bending radius: R4 mm R0.157 in or less) features.

New product introduction
Tough Fiber

Fiber Selection Guide

Model
Choose by shape/application
How to read Model No.
Earlier models comparison table

Fibers

- Super Quality
- Threaded Type
- Square Head Type
- Cylindrical Type
- Sleeve
- Flat Type
- Small Spot
- Narrow Beam
- Wide Beam
- Convergent Reflective Type
- Retroreflective Type
- Chemical / Oil-resistant
- Heat-resistant
- Vacuum-resistant
- Liquid Leak / Liquid Detection

Fiber Options

Semi-custom fibers

Fiber Dimensions

- Thru-beam Type
- Retroreflective Type
- Reflective Type
- Others

Amplifiers

- FX-500 series
- FX-100 series

INDEX

New product introduction
Tough Fiber

Fiber Selection Guide

Model

Choose by shape/application

How to read Model No

Earlier models comparison table

Fibers

Super Quality

Threaded Type

Square Head Type

Cylindrical Type

Sleeve

Flat Type

Small Spot

Narrow Beam

Wide Beam

Convergent Reflective Type

Retroreflective Type

Chemical / Oil-resistant

Heat-resistant

Vacuum-resistant

Liquid Leak / Liquid Detection

Fiber Options

Semi-custom fibers

Fiber Dimensions

Thru-beam Type

Retroreflective Type

Reflective Type

Others

Amplifiers

FX-500 series

FX-100 series

INDEX

Square Head Type

- Compact, space-saving design brings clean installation on the side of a conveyor belt.
- As for lens compatible type fiber head, sensing range becomes longer when a lens is attached to the thru-beam type fiber, spot detection is achieved in case of the reflective type.
- A lens equipped type fiber head is also available.
- Oil resistant type is also available. Please refer to p.28

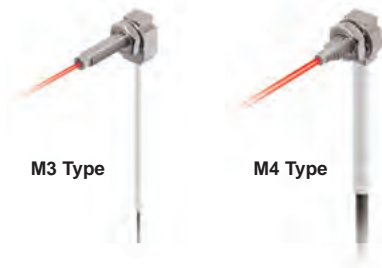

Compact, space-saving

Fiber can be installed at a minimum pitch of M3: 6.5 mm 0.256 in or M4: 8.5 mm 0.335 in using needle-nose pliers.

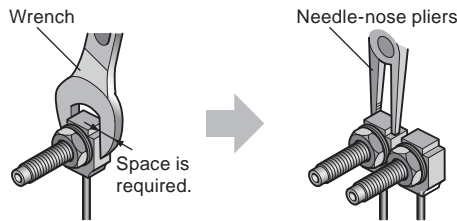

Compact installation

Square head fiber heads can be installed cleanly on the side of a conveyor belt. The design makes it less likely for tools and other objects to catch on the fiber cable during installation.

FT-R□ / FD-R□



Standard fiber



Introducing square R1 mm (R0.039 in) (sharp bending) fiber

We now offer a sharp bending fiber featuring a low level of light fluctuations, even when bent at R1 mm R0.039 in. It is also available with a lens capable of long-range sensing.

FT-R41W/R42W

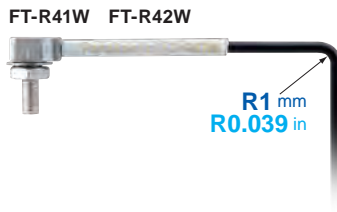

FT-R42W (With lens)

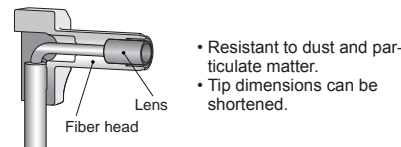

Full-protection type

High environmental resistance

The head, nut, and washer are made from rust-resistant SUS304. The unbreakable tough fiber with high durability is covered in a fluorine resin tube. The fiber head is also covered with a fluorine resin component, achieving a high level of environmental resistance.

Less susceptibility to oil adhesion thanks to fluorine resin

Fibers deliver stable detection, since the sensing part is sealed with fluorine resin, which does not allow oil penetration. Additionally, the detection part features a convex design made of fluorine resin, achieving lower friction than glass.

Resistant to oil and coolant

The fiber head and fiber cable are connected by the "fastening and caulking" method without using adhesives. This method eliminates concerns that adhesives will absorb moisture in high-humidity environments and damage the fiber. The enclosure achieves IP68G protection, so the fiber can be installed around metal processing machines shrouded in the oil mist.

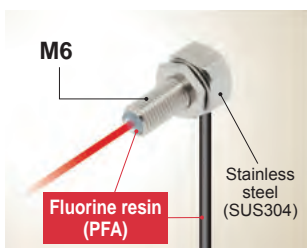
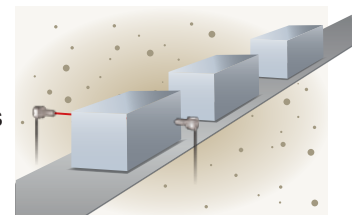

Test oil	Product
Lubricating oil	Velocite Oil No. 3
Non-water-soluble cutting oil	Yushiron Cut Abas KZ201
	Yushiron Cut UH75
Water-soluble cutting oil	Syntilo 9954 (10% diluted)
	Yushiroken S50N (2% diluted)
Alcohol-based neutral detergent	Super Teepol

*Yushiron and Yushiroken are registered trademarks of Yushiro Chemical Industry Co., Ltd.

Cable-protection type FT-R44Y / FD-R61Y

FT-R44Y (Square head type M4 / thru-beam type)

FD-R61Y (Square head type M6 / reflective type)

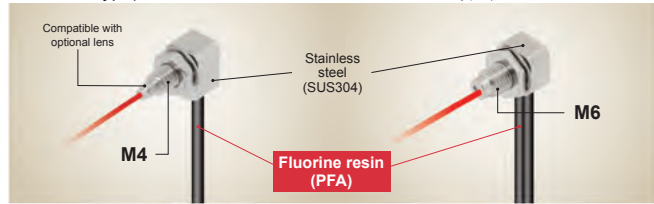

Even stronger than tough fiber

The tough fiber has been reinforced by covering it with a fluorine resin tube so that it can be used even in harsh environments where oils and solvents are used. The fiber cable will not harden or break, even if it is splashed with oil.



Protective structure IP67

The head, nut, and washer are made from rust-resistant SUS304.



LIST OF FIBERS

Thru-beam type (one pair set)

Type	Shape of fiber head (mm)	Model No.	Bending radius (mm)	Fiber cable length Free-cut	Sensing range (mm in) (Note 1)			Beam axis dia. (Fiber Core) (mm)	Protection	Ambient temp.	Dimensions
					FX-500 series	U-LG LONG FAST H-SP	FX-101 (Upper value) FX-102 (Lower value)				
Square head	M3 W5.5xH8xD16	Tough FT-R31	R2 Bending durability	2m	STD 270 10.630 HYPR 1,000 39.370	580 22.835 440 17.323 160 6.299 55 2.165	100 3.937 340 13.386	∅0.5	IP67	-55 to +80 °C	P.51
		Tough FT-R43	R4 Bending durability		STD 720 28.346 HYPR 3,000 118.110	1,600 62.992 1,100 43.307 430 16.929 130 5.118	210 8.268 640 25.197	∅1			
	M4 W7xH9xD13.9	FT-R41W	R1		STD 800 31.496 HYPR 3,200 125.984	1,800 70.866 1,400 55.118 460 18.110 150 5.906	250 9.843 710 27.953	∅2.2	IP40	-40 to +60 °C	
		FT-R42W			With expansion lens W7xH9xD1.4.4	STD 2,200 86.614 HYPR (Note2) 3,600 141.732	3,600 141.732 (Note 2) 3,500 137.795 1,300 51.181 460 18.110				
	M4 W7xH9.5xD15.5	Tough NEW FT-R44Y	R4		STD 720 28.346 HYPR 3,000 118.110	1,600 62.992 1,100 43.307 430 16.929 130 5.118	210 8.268 640 25.197	∅1	IP67 (Note 3)	-55 to +80 °C	
M6 W10xH11xD21.2	Tough NEW FT-R60Y	R4 Bending durability	STD 2,100 82.677 HYPR (Note2) 3,600 141.732	3,600 141.732 (Note 2) 3,600 141.732 (Note 2) 1,260 49.606 400 15.748	690 27.165 1,890 74.409	∅3.5	IP68G				

Notes: 1) Note that the sensing range of the free-cut type fiber may be reduced by 20 % max. depending upon how the fiber is cut.
2) The fiber cable length practically limits the sensing range.
3) The fiber part is oil-resistant.

Reflective type

Type	Shape of fiber head (mm)	Model No.	Bending radius (mm)	Fiber cable length Free-cut	Sensing range (mm in) (Note 1, 2)			Beam axis dia. (Fiber Core) (mm)	Protection	Ambient temp.	Dimensions
					FX-500 series	U-LG LONG FAST H-SP	FX-101 (Upper value) FX-102 (Lower value)				
Square head	M3 W5.5xH8xD16	Tough FD-R31G	R2 Bending durability	500mm	STD 170 6.693 HYPR 530 20.866	310 12.205 260 10.236 85 3.346 27 1.063	45 1.772 150 5.906	Emitter ∅0.5	IP40	-55 to +80 °C	P.63
		FD-R32EG	R4		STD 45 1.772 HYPR 170 6.693	110 4.331 92 3.622 30 1.181 9 0.354	20 0.787 68 2.677	Emitter ∅0.25			
		FD-R34EG	STD 38 1.496 HYPR 130 5.118		90 3.543 70 2.756 23 0.906 7 0.276	17 0.669 60 2.362	Emitter ∅0.175				
		FD-R33EG	STD 19 0.748 HYPR 84 3.307		44 1.732 33 1.299 11 0.433 3 0.118	7 0.276 22 0.866	Emitter ∅0.125				
	M4 W7xH9xD13.5	Tough FD-R41	R2 Bending durability	STD 210 8.268 HYPR 710 27.953	430 16.929 320 12.598 100 3.937 34 1.339	60 2.362 170 6.693	∅0.75	IP67	-55 to +80 °C		
M6 W10xH11xD15.5	Tough NEW FD-R61Y	R4 Bending durability	STD 280 11.024 HYPR 990 38.976	610 24.016 435 17.126 160 6.299 50 1.969	85 3.346 185 7.283	—	IP67 (Note 3)				

Notes: 1) Note that the sensing range of the free-cut type fiber may be reduced by 20 % max. depending upon how the fiber is cut.
2) The sensing range is specified for white non-glossy paper.
3) The fiber part is oil-resistant.

FIBER OPTIONS

Lens (For thru-beam type fiber) ▶P.42

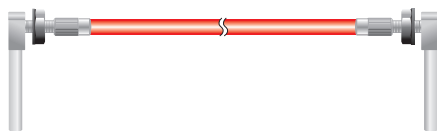

Lens (For square head M3 reflective fiber) ▶P.43



Tough : Refers to a fiber which possesses both unbreakable (bending radius: R10 mm R0.394 in, reciprocating bending: 180°) and more flexible (bending radius: R4 mm R0.157 in or less) features.

New product introduction

Tough Fiber

Fiber Selection Guide

Model

Choose by shape/application

How to read Model No.

Earlier models comparison table

Fibers

Super Quality

Threaded Type

Square Head Type

Cylindrical Type

Sleeve

Flat Type

Small Spot

Narrow Beam

Wide Beam

Convergent Reflective Type

Retroreflective Type

Chemical / Oil-resistant

Heat-resistant

Vacuum-resistant

Liquid Leak / Liquid Detection

Fiber Options

Semi-custom fibers

Fiber Dimensions

Thru-beam Type

Retroreflective Type

Reflective Type

Others

Amplifiers

FX-500 series

FX-100 series

INDEX

Cylindrical Type

- Has a slender shape which can be mounted in narrow locations using set screws.
- Line up that includes ultra-thin fibers with $\phi 0.25$ mm tips.



<Thru-beam type> FT-S21/S21W/S31W
<Reflective type> FD-S32/S31

- User-friendly, high quality fiber
- Improved centering accuracy and specularity

Stainless steel fittings are used for the fiber head of all models.

- Clearly conforms to RoHS
- Can be used for secondary battery
- Improved mounting strength

LIST OF FIBERS

Thru-beam type (one pair set)

Type	Shape of fiber head (mm)	Model No.	Bending radius (mm)	Fiber cable length : Free-cut	Sensing range (mm in) (Note 1)			Beam axis dia. (mm)	Beam axis position/Inclination of beam axis	Protection	Ambient temp.	Dimensions		
					FX-500 series	U-LG LONG FAST H-SP	FX-101 (Upper value) FX-102 (Lower value)							
Cylindrical	$\phi 1$	Tough FT-S11	R2	500 mm	STD 190 3.543 HYPR 350 13.780	210 8.268 160 6.299 60 2.362 19 0.748	40 1.575 90 3.543	$\phi 0.25$	—	—	-55 to +80 °C	P.52		
	$\phi 1.5$	Tough FT-S21	R1	2 m	STD 770 30.315 315 12.402 HYPR 1,350 53.150	590 23.228 440 17.323 150 5.906 70 2.756	130 5.118 340 13.386	$\phi 0.5$	150 μ m / $\pm 2^\circ$	IP67	-40 to +60 °C			
		FT-S21W			STD 260 10.236 HYPR 990 38.976	590 23.228 440 17.323 150 5.906 53 2.087	80 3.150 240 9.449		150 μ m / $\pm 3^\circ$					
	$\phi 2.5$	With lens, Long sensing range $\phi 2.5$	FT-S32	R10	2 m	STD 3,100 122.047 HYPR (Note 2) 3,600 141.732	3,600 141.732 (Note 2) 1,800 70.866 600 23.622	1,100 43.307 3,000 118.110	$\phi 2$	—	IP40		-40 to +70 °C	
	$\phi 3$	FT-S31W	R1	STD 800 31.496 HYPR 3,300 129.921		1,900 74.803 1,400 55.118 490 19.291 160 6.299	260 10.236 720 28.346	$\phi 1$	150 μ m / $\pm 3^\circ$	—	-40 to +60 °C			
	Side-view Ultra-small diameter	Narrow beam $\phi 0.125$ mm	Tough FT-E13	R2	1 m	STD 15 0.591 HYPR 52 2.047	30 1.181 24 0.945 8 0.315 2 0.079	6 0.236 19 0.748	$\phi 0.125$	—	IP67		-40 to +70 °C	P.49
		Sleeve part cannot be bent.	Tough FT-E23	R4		STD 75 2.953 HYPR 270 10.630	160 6.299 125 4.921 42 1.654 13 0.512	22 0.866 80 3.150	$\phi 0.25$	—	—		-40 to +70 °C	
		Narrow beam $\phi 0.25$ mm	Tough FT-V40	R4		STD 3,500 137.795 HYPR (Note 2) 3,600 141.732	3,600 141.732 (Note 2) 3,600 141.732 (Note 2) 2,400 94.488 850 33.465	1,000 39.370 3,100 122.047	$\phi 2.5$	—	IP50		-40 to +60 °C	

Notes: 1) Note that the sensing range of the free-cut type fiber may be reduced by 20 % max. depending upon how the fiber is cut.
2) The fiber cable length practically limits the sensing range.

Tough : Refers to a fiber which possesses both unbreakable (bending radius: R10 mm R0.394 in, reciprocating bending: 180°) and more flexible (bending radius: R4 mm R0.157 in or less) features.

Reflective type

Type	Shape of fiber head (mm)	Model No.	Bending radius (mm)	Fiber cable length Free-cut	Sensing range (mm in) (Note 1, 2)			Beam axis position/ Inclination of beam axis	Protection	Ambient temp.	Dimensions
					FX-500 series	U-LG LONG FAST H-SP	FX-101 (Upper value) FX-102 (Lower value)				
Cylindrical		Tough FD-S21	R2 Bending durability	1 m	STD 80 3.150 HYPR 190 7.480	130 5.118 110 4.331 37 1.457 11 0.433	25 0.984 70 2.756	—	IP40	-55 to +80 °C	P.63
		Tough FD-S32	R4 Bending durability	2 m	STD 420 16.535 HYPR 1,200 47.244	790 31.102 660 25.984 220 8.661 75 2.953	120 4.724 345 13.583	150 μm /±3°	IP67	-40 to +60 °C	P.64
		FD-S32W	R1		STD 270 10.630 HYPR 900 35.433	630 24.803 430 16.929 150 5.906 45 1.772	80 3.150 230 9.055	—			
		Tough FD-S31	R2 Bending durability	1 m	STD 125 4.921 HYPR 515 20.276	290 11.417 220 8.661 80 3.150 25 0.984	35 1.378 140 5.512	150 μm /±3°	IP40	-40 to +60 °C	P.58
		FD-S33GW	R1		STD 150 5.906 HYPR 670 26.378	340 13.386 280 11.024 90 3.543 25 0.984	45 1.772 140 5.512	—			
Ultra-small diameter		FD-E13	R4	1 m	STD 12 0.472 HYPR 50 1.969	29 1.142 25 0.984 7 0.276 2 0.079	5 0.197 15 0.591	—	IP40	-40 to +70 °C	P.58
		FD-E23			STD 55 2.165 HYPR 170 6.693	120 4.724 80 3.150 30 1.181 9 0.354	20 0.787 70 2.756	—			

Notes: 1) Note that the sensing range of the free-cut type fiber may be reduced by 20 % max. depending upon how the fiber is cut.
2) The sensing range is specified for white non-glossy paper.

Tough : Refers to a fiber which possesses both unbreakable (bending radius: R10 mm R0.394 in, reciprocating bending: 180°) and more flexible (bending radius: R4 mm R0.157 in or less) features.

Sleeve

- It is suitable for sensing in narrow locations and sensing minute objects because the fiber tip is a thin sleeve.
- The 40 mm sleeve type can be bent in any direction.



<Thru-beam type> FT-E13 / FT-E23 Ultra-small diameter fiber

Centering accuracy of 1/10 mm or less

Ultra-small diameter fibers with a compact head ensure precision centering accuracy* to stably detect minute parts.

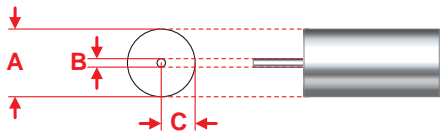

* Tolerance of A + Tolerance of B + Tolerance of C = ±0.09 mm

Dimensions UNCLEAR

Previous general fiber

Extra clearance needs to be added when designing and machining the mounting hole due to unclear dimensions. As a result, mounting variation increases and the beam axis deviates, resulting in a decrease in sensing accuracy or causing the sleeve to bend or break.

Dimensions CLEAR

Example: FT-E13

New standard fiber

Highly accurate design and machining are possible due to clear mounting hole dimensions. As a result, mounting variation is minimal, improving sensing accuracy. In addition to this, as the beam axis alignment is not affected when the fiber is changed, readjustment is not necessary.

Minute sensing only possible with ultra small fiber

Detection of fine-pitch connector pins

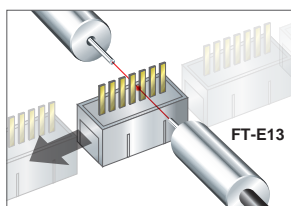

Ultra-small diameter fiber with $\varnothing 0.125 \text{ mm } \varnothing 0.005 \text{ in}$ beam axis is able to detect the insertion or bending of fine-pitch connector pins.

Detection of tiny chips

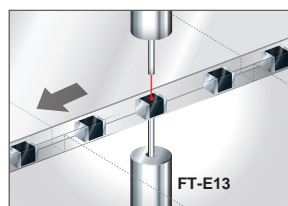

Fiber can be installed with only the $\varnothing 0.25 \text{ mm } \varnothing 0.010 \text{ in}$ sleeve close to the minute section.

Stainless steel fittings are used for the fiber head of all models.

- Clearly conforms to RoHS
- Can be used for secondary battery
- Improved mounting strength

Application

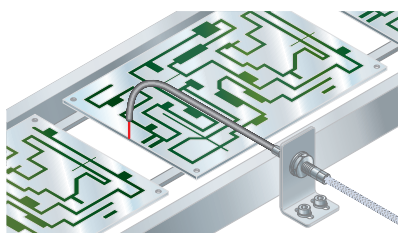

FIBER OPTION

Fiber bender

-FB-1

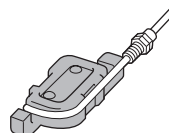

The fiber bender bends the sleeve part of the fiber head at the proper radius.

Note: Do not bend the sleeve part of any side-view type fiber or ultra-small diameter head type fiber.

LIST OF FIBERS

Thru-beam type (one pair set)

Type	Shape of fiber head (mm)	Model No.	Bending radius (mm)	Fiber cable length Free-cut	Sensing range (mm in) (Note 1, 2)			Beam axis dia. (mm)	Protection	Ambient temp.	Dimensions
					FX-500 series	U-LG LONG FAST H-SP	FX-101 (Upper value) FX-102 (Lower value)				
Threaded	M3 Sleeve 40mm M3 ø0.88 10	Tough FT-31S	R2 Bending durability (Note 3)	2 m	STD 315 12.402 HYPR 1,220 48.031	740 29.134 550 21.654 195 7.677 63 2.480	130 5.118 340 13.386	ø0.5	IP67	-55 to +80 °C	P.48
	M4 Sleeve 40mm M4 ø1.48 12	Tough FT-42S	R4 Bending durability (Note 3)	2 m	STD 1,130 44.488 HYPR (Note 2) 3,600 141.732	2,050 80.709 1,600 62.992 530 20.866 190 7.480	300 11.811 800 31.496	ø1			
Cylindrical	Ultra-small diameter ø3 Narrow beam ø0.125mm Sleeve part cannot be bent. ø0.25 ø3 5 15	Tough FT-E13	R2 Bending durability	1 m	STD 15 0.591 HYPR 52 2.047	30 1.181 24 0.945 8 0.315 2 0.079	6 0.236 19 0.748	ø0.125	IP67	-40 to +70 °C	P.49
		Tough FT-E23	R2 Bending durability	1 m	STD 175 2.953 HYPR 270 10.630	160 6.299 125 4.921 42 1.654 13 0.512	22 0.866 80 3.150	ø0.25			
	Side-view ø2 Sleeve part cannot be bent. ø1 ø2 20 15	Tough FT-V23	R4 Bending durability	2 m	STD 450 17.717 HYPR 1,800 70.866	1,000 39.370 880 34.646 280 11.024 90 3.543	160 6.299 400 15.748	ø0.75	IP30	-55 to +80 °C	P.52
		Tough FT-V25	R2 Bending durability		STD 240 9.449 HYPR 900 35.433	550 21.654 480 18.898 140 5.512 45 1.772	95 3.740 260 10.236	ø0.5			
	Side-view ø2.5 Sleeve part cannot be bent. ø1 ø2 15 15	Tough FT-V24W	R1	2 m	STD 110 4.331 HYPR 380 14.961	230 9.055 200 7.874 60 2.362 20 0.787	35 1.378 90 3.543	ø0.5	IP30	-40 to +60 °C	P.53
		Tough FT-V30	R4 Bending durability		STD 680 26.772 HYPR 2,200 86.614	1,200 47.244 1,000 39.370 340 13.386 100 3.937	180 7.087 480 18.898	ø1.0			

Notes: 1) Note that the sensing range of the free-cut type fiber may be reduced by 20 % max. depending upon how the fiber is cut.
 2) The fiber cable length practically limits the sensing range.
 3) Bending radius of sleeve part is R10 mm R0.394 in or more.

Reflective type

Type	Shape of fiber head (mm)	Model No.	Bending radius (mm)	Fiber cable length Free-cut	Sensing range (mm in) (Note 1, 2)			Protection	Ambient temp.	Dimensions
					FX-500 series	U-LG LONG FAST H-SP	FX-101 (Upper value) FX-102 (Lower value)			
Threaded	Ultra-small diameter M3 Sleeve 15 mm M3 ø0.8 15 Sleeve part cannot be bent.	FD-EG30S	R4	1 m	STD 50 1.969 HYPR 170 6.693	110 4.331 80 3.150 30 1.181 9 0.354	20 0.787 70 2.756	IP40	-40 to +70 °C	P.59
	M4 Sleeve 40 mm M4 ø1.48 12	Tough FD-41S	R2 Bending durability (Note 3)	2 m	STD 125 4.921 HYPR 515 20.276	290 11.417 220 8.661 80 3.150 25 0.984	35 1.378 140 5.512	IP67	-55 to +80 °C	P.56
		Tough FD-41SW	R1 (Note 3)		STD 80 3.150 HYPR 330 12.992	180 7.087 140 5.512 45 1.772 12 0.472	15 0.591 60 2.362			
	M6 Sleeve 40 mm M6 ø2.5 15	Tough FD-61S	R4 Bending durability (Note 3)	2 m	STD 420 16.535 HYPR 1,200 47.244	790 31.102 660 25.984 220 8.661 75 2.953	130 5.118 360 14.173	IP67	-55 to +80 °C	P.57
Cylindrical	Ultra-small diameter ø1.5 ø0.48 15 15 Sleeve part cannot be bent.	FD-E13	R4	1 m	STD 12 0.472 HYPR 50 1.969	29 1.142 25 0.984 7 0.276 2 0.079	5 0.197 15 0.591	IP40	-40 to +60 °C	P.58
		FD-E23	R4		STD 55 2.165 HYPR 170 6.693	120 4.724 80 3.150 30 1.181 9 0.354	20 0.787 70 2.756			
	Side-view ø3 Small diameter ø3 ø1.5 15 15 Sleeve part cannot be bent.	Tough FD-V30	R2 Bending durability	2 m	STD 65 2.559 HYPR 240 9.449	130 5.118 120 4.724 35 1.378 14 0.551	25 0.984 75 2.953	IP30	-55 to +80 °C	P.64
		Tough FD-V30W	R1		STD 20 0.787 HYPR 80 3.150	40 1.575 30 1.181 10 0.394 2 0.079	6 0.236 20 0.787			
		Tough FD-V50	R4 Bending durability		STD 120 4.724 HYPR 370 14.567	220 8.661 210 8.268 75 2.953 25 0.984	40 1.575 100 3.937			

Notes: 1) Note that the sensing range of the free-cut type fiber may be reduced by 20 % max. depending upon how the fiber is cut.
 2) The sensing range is specified for white non-glossy paper.
 3) Bending radius of sleeve part is R10 mm R0.394 in or more.

Tough : Refers to a fiber which possesses both unbreakable (bending radius: R10 mm R0.394 in, reciprocating bending: 180°) and more flexible (bending radius: R4 mm R0.157 in or less) features.

New product introduction

Tough Fiber

Fiber Selection Guide

Model

Choose by shape/application
How to read Model No.
Earlier models comparison table

Fibers

Super Quality

Threaded Type

Square Head Type

Cylindrical Type

Sleeve

Flat Type

Small Spot

Narrow Beam

Wide Beam

Convergent Reflective Type

Retroreflective Type

Chemical / Oil-resistant

Heat-resistant

Vacuum-resistant

Liquid Leak / Liquid Detection

Fiber Options

Semi-custom fibers

Fiber Dimensions

Thru-beam Type

Retroreflective Type

Reflective Type

Others

Amplifiers

FX-500 series

FX-100 series

INDEX

Flat Type

Since it has a thin, rectangular shape, it can be installed in narrow locations. It is also a fiber with good workability and can be mounted directly with screws.

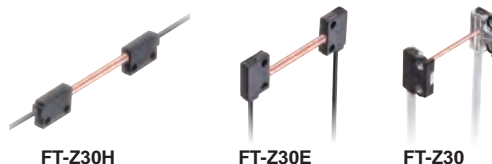

1 point mounting

The sensor can be mounted on 1 point with either M2 screw or M3 screw. Metal sleeve in the enclosure helps to be tightened firmly even with a single screw.

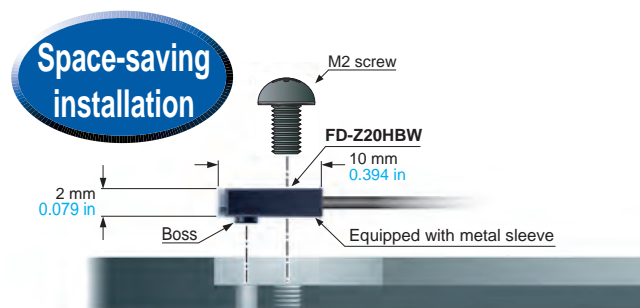

Fiber guide system contributes to space-saving

FT-Z□HBW and FD-Z□HBW is equipped with a fiber guide system. This enables to mount either way of top sensing and side sensing.

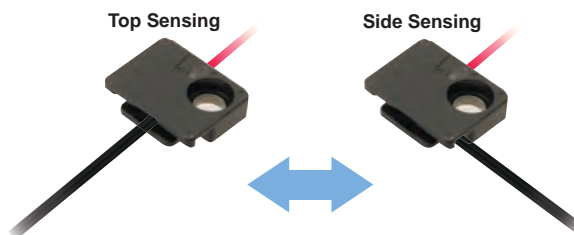

LIST OF FIBERS

Thru-beam type (one pair set)

Type	Shape of fiber head (mm)	Model No.	Bending radius (mm)	Fiber cable length Free-cut	Sensing range (mm in) (Note 1)			Beam axis dia. (mm)	Protection	Ambient temp.	Dimensions	
					FX-500 series	U-LG LONG FAST H-SP	FX-101 (Upper value) FX-102 (Lower value)					
Flat	Top sensing W3 x H8 x D12	Tough FT-Z30H	R2	2 m	STD 3,500 137.795	3,600 141.732 (Note 2)	1,400 55.118	2 x 3	IP40	-40 to +60 °C	P.54	
	Top sensing W3 x H8 x D12	FT-Z30HW	R1		HYPR (Note 2) 3,600 141.732	3,600 141.732 (Note 2)	2,600 102.362 810 31.890					3,200 125.984
	Side sensing W3 x H12 x D8	Tough FT-Z30E	R2		STD 3,500 137.795	3,600 141.732 (Note 2)	2,400 94.488 740 29.134					1,200 47.244 3,200 125.984
	Side sensing W3 x H12 x D8	FT-Z30EW	R1		STD 3,400 133.858	3,600 141.732 (Note 2)	2,000 78.740 630 24.803					1,400 55.118 2,600 102.362
	Front sensing W8.5 x H12 x D3	Tough FT-Z30	R2		STD 2,100 82.677	3,600 141.732 (Note 2)	1,200 47.244 410 16.142					710 27.953 2,300 90.551
	Front sensing W8.5 x H12 x D3	FT-Z30W			STD 1,500 59.055	3,300 129.921 3,200 125.984	1,000 39.370 280 11.024					540 21.260 1,800 70.866
	Front sensing W10 x H7 x D2	FT-Z20W			STD 620 24.409	1,500 59.055 1,100 43.307	420 16.535 130 5.118	280 11.024 730 28.740				
	Fiber bending type W2 x H10 x D10	FT-Z20HBW	R1		STD 260 10.236	670 26.378 570 22.441	180 7.087 55 2.165	100 3.937 320 12.598				
	Front sensing W14 x H7 x D3.5	FT-Z40W			STD 1,500 59.055	3,300 129.921 2,300 90.551	900 35.433 290 11.417	410 16.142 1,200 47.244				
	Fiber bending type W3.5 x H14 x D11	FT-Z40HBW			STD 800 31.496	1,900 74.803 1,400 55.118	490 19.291 160 6.299	260 10.236 720 28.346				

Notes: 1) Note that the sensing range of the free-cut type fiber may be reduced by 20 % max. depending upon how the fiber is cut.
2) The fiber cable length practically limits the sensing range.

Tough : Refers to a fiber which possesses both unbreakable (bending radius: R10 mm R0.394 in, reciprocating bending: 180°) and more flexible (bending radius: R4 mm R0.157 in or less) features.

New product
introductionTough
FiberFiber
Selection
Guide

Model

Choose
by shape/
applicationHow to read
Model No.Earlier models
comparison
table

Fibers

Super
QualityThreaded
TypeSquare Head
TypeCylindrical
Type

Sleeve

Flat
TypeSmall
SpotNarrow
BeamWide
BeamConvergent
Reflective
TypeRetroreflective
TypeChemical / Oil-
resistant

Heat-resistant

Vacuum-
resistantLiquid Leak /
Liquid DetectionFiber
OptionsSemi-custom
fibersFiber
DimensionsThru-beam
TypeRetroreflective
TypeReflective
Type







Others

Amplifiers

FX-500
seriesFX-100
series

INDEX

Reflective type

Type	Shape of fiber head (mm)	Model No.	Bending radius (mm)	Fiber cable length  : Free-cut	Sensing range (mm in) (Note 1, 2)			Protection	Ambient temp.	Dimensions
					FX-500 series	U-LG LONG FAST H-SP	FX-101 (Upper value) FX-102 (Lower value)			
Flat With boss	Front sensing  W10 x H7 x D2	FD-Z20W	R1	1 m 	STD 1 to 65 0.039 to 2.559	150 5.906 130 5.118	2 to 32 0.079 to 1.260	IP40	-40 to +60 °C	P.65
	Fiber bending type  W2 x H10 x D10	FD-Z20HBW			HYPR 260 10.236	2 to 45 0.079 to 1.772 5 to 13 0.197 to 0.512	0.039 to 3.150			
	Front sensing  W14 x H7 x D3.5	FD-Z40W		2 m 	STD 190 7.480	440 17.323 390 15.354	1 to 74 0.039 to 2.913	IP40		
	Fiber bending type  W3.5 x H14 x D11	FD-Z40HBW			HYPR 790 31.102	1 to 120 0.039 to 4.724 2 to 35 0.079 to 1.378	200 7.874			
					STD 260 10.236	540 21.260 470 18.504	1 to 90 0.039 to 3.543	IP67		
					HYPR 760 29.921	1 to 160 0.039 to 6.299 2 to 50 0.079 to 1.969	0.5 to 240 0.020 to 9.449			

Notes: 1) Note that the sensing range of the free-cut type fiber may be reduced by 20 % max. depending upon how the fiber is cut.

2) The sensing range is specified for white non-glossy paper.

Small Spot

■ Sensing of minute objects can be performed by combining the fiber and spot lens. The spot diameter can also be changed.



Applications

Packing detection



Because it's a side-view type, it can be mounted even in narrow spaces.

Number of IC pins checking

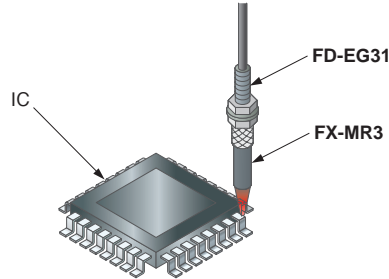

Discrimination of 0603 chip direction

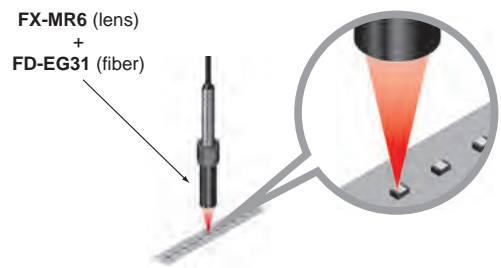

Three optional lenses for reflective type fiber are available. Perfect for chip component detection applications.

FX-MR7 / MR8 / MR9

Finest spot lens FX-MR7

About 3 times more light received (compared to previous models)

Since there is a large difference in the amount of light received in applications such as direction detection, it is easy to set a threshold that will allow stable detection. Additionally, these products offer an S/N ratio that is 1.3 times better than previous models.



Parallel light lens FX-MR9

Long-range parallel light

Depending on the fiber with which it is used, this lens creates parallel light with a spot diameter of approximately $\varnothing 4$ mm $\varnothing 0.157$ in at a sensing range of 0 to 30 mm 0 to 1.181 in.



Typical FX-501 erformance (STD mode)

	White	Black
FX-MR7 + FD-R33EG	3,200 digits	1,030 digits
FX-MR6 (compared to previous models) + FD-R33EG	1,000 digits	435 digits

Zoom lens FX-MR8

Variable spot diameter

Spot diameters ranging from $\varnothing 0.4$ to $\varnothing 3.5$ mm $\varnothing 0.016$ to $\varnothing 0.138$ in can be achieved by combining the lens with a variety of fibers.



All models

Tightening torque 5 times (compared to previous models)

The standard aluminum body has been changed to stainless steel (SUS 303) to reduce the likelihood of damage from over-tightening.

Standard lens outer diameter of $\varnothing 4.3$ mm ($\varnothing 0.169$ in)

Use of the same mounting hardware across the product line means less inventory and lower costs.

LIST OF FIBERS

High precision fiber & spot lens

Designation	Shape of head (mm) Dimensions	Spot diameter (mm in) (Note)	Distance to focal point (mm in) (Note)	Lens		Applicable fibers																			
				Model No.	Ambient temp.	Model No.	Fiber cable length : Free-cut	Bending radius (mm)	Protection	Ambient temp.	Dimensions														
Finest spot lens		ø0.1 ø0.004	7±0.5 0.276±0.020	FX-MR6	-20 to +60 °C	FD-EG31	500 mm	R4	IP40		-20 to +60 °C	P.59													
	P.68	FD-EG30				-40 to +70 °C							P.58												
		ø0.2 ø0.008					Tough FD-42G	2 m						R2 Bending durability	-55 to +80 °C	P.57									
	P.68	FD-42GW				R1	-40 to +60 °C																		
		ø0.4 ø0.016				Tough FD-32G	1 m	R2 Bending durability						-55 to +80 °C	P.56										
	P.68	FD-32GX				R2		-40 to +60 °C																	
		ø0.15 ø0.006				7.5±0.5 0.295±0.020	FX-MR3	-40 to +70 °C						FD-EG31			500 mm	R4			-20 to +60 °C	P.59			
	P.68	FD-EG30												-40 to +70 °C									P.58		
		ø0.3 ø0.012															Tough FD-42G	2 m						R2 Bending durability	-55 to +80 °C
	P.68	FD-42GW												R1			-40 to +60 °C								
	ø0.5 ø0.020	Tough FD-32G	1 m	R2 Bending durability	-55 to +80 °C				P.56																
P.68	FD-32GX	R2		-40 to +60 °C																					
Pinpoint spot lens		ø0.5 ø0.020	6±1 0.236±0.039	FX-MR1	-40 to +70 °C					Tough FD-42G	2 m	R2 Bending durability				-55 to +80 °C	P.57								
	P.67	FD-42GW								R1		-40 to +60 °C													
Zoom lens		ø0.7 to ø2.0 ø0.028 to ø0.079	Approx. 18.5 to 43 Approx. 0.728 to 1.693	FX-MR2	-40 to +70 °C					Tough FD-42G	2 m	R2 Bending durability			-55 to +80 °C	P.57									
	P.67	FD-42GW								R1		-40 to +60 °C													
Zoom lens (Side-view type)		ø0.5 to ø3.0 ø0.020 to ø0.118	Approx. 13 to 30 Approx. 0.512 to 1.181	FX-MR5	-40 to +70 °C	Tough FD-42G		R2 Bending durability				-55 to +80 °C	P.57												
	P.68	FD-42GW				R1		-40 to +60 °C																	

Square head type M3, Reflective type fiber & spot lens

Type	Spot diameter (mm in) (Note)	Distance to focal point (mm in) (Note)	Lens		Fiber			
			Shape (mm in) Dimensions	Model No.	Shape	Emitting fiber core (mm in)	Model No.	
Finest spot lens	ø0.1 ø0.004 approx.	7 ± 0.5 0.276 ± 0.020		FX-MR7	P.68		ø0.125 ø0.005	FD-R33EG
	ø0.15 ø0.006 approx.						ø0.125 ø0.005	FD-EG31
	ø0.2 ø0.008 approx.						ø0.175 ø0.007	FD-R34EG
	ø0.4 ø0.016 approx.						ø0.25 ø0.010	FD-R32EG
							ø0.25 ø0.010	FD-EG30
							ø0.5 ø0.020	FD-R31G
							ø0.5 ø0.020	FD-32G
							ø0.5 ø0.020	FD-32GX
							ø0.5 ø0.020	FD-42G
								ø0.5 ø0.020
Zoom lens	ø0.4 to ø2.0 ø0.016 to ø0.079 approx.	10 to 30 0.394 to 1.181		FX-MR8	P.68		ø0.125 ø0.005	FD-R33EG, FD-EG31
	ø0.4 to ø2.2 ø0.016 to ø0.087 approx.						ø0.175 ø0.007	FD-R34EG
	ø0.5 to ø2.5 ø0.020 to ø0.098 approx.						ø0.25 ø0.010	FD-R32EG, FD-EG30
	ø0.8 to ø3.5 ø0.031 to ø0.138 approx.						ø0.5 ø0.020	FD-R31G, FD-32G, FD-32GX, FD-42G, FD-42GW
Parallel light lens	ø4.0 ø0.157 approx.	0 to 30 0 to 1.181		FX-MR9	P.68		ø0.125 ø0.005	FD-R33EG, FD-EG31
							ø0.175 ø0.007	FD-R34EG
							ø0.25 ø0.010	FD-R32EG, FD-EG30
							ø0.5 ø0.020	FD-R31G, FD-32G, FD-32GX, FD-42G, FD-42GW

Note: Spot diameter, distance to focal point and sensing range are specified for FX-500/FX-100 series.

Tough : Refers to a fiber which possesses both unbreakable (bending radius: R10 mm R0.394 in, reciprocating bending: 180°) and more flexible (bending radius: R4 mm R0.157 in or less) features.

New product introduction

Tough Fiber

Fiber Selection Guide

Model

Choose by shape/application
How to read Model No.
Earlier models comparison table

Fibers

Super Quality

Threaded Type

Square Head Type

Cylindrical Type

Sleeve

Flat Type

Small Spot

Narrow Beam

Wide Beam

Convergent Reflective Type

Retr reflective Type

Chemical / Oil-resistant

Heat-resistant

Vacuum-resistant

Liquid Leak / Liquid Detection

Fiber Options

Semi-custom fibers

Fiber Dimensions

Thru-beam Type

Retr reflective Type

Reflective Type

Others

Amplifiers

FX-500 series

FX-100 series

INDEX

Narrow Beam

Since the beam is narrow, it has a feature by which it is not easily affected by surrounding obstacles even in long distances.

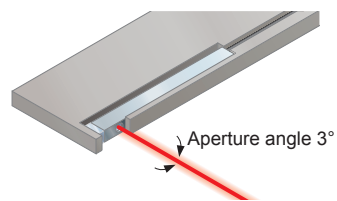

Applications

Detection of a transparent tube



Mapping of a wafer



Detection of a wafer



LIST OF FIBERS

Thru-beam type (one pair set)

Type	Shape of fiber head (mm)	Model No.	Bending radius (mm)	Fiber cable length (m) Free-cut	Sensing range (mm in) (Note 1)			Beam axis dia. (mm)	Beam axis position/ inclination of beam axis	Protection	Ambient temp.	Dimensions
					FX-500 series	U-LG LONG FAST H-SP	FX-101 (Upper value) FX-102 (Lower value)					
Narrow beam Side-view	Aperture angle 2° 	Tough FT-KS40	R2	2 m	STD (Note 2) 3,600 141.732 HYPR (Note 2) 3,600 141.732	3,600 141.732 (Note 2) 3,600 141.732 (Note 2) 1,200 47.244	2,200 86.614 (Note 2) 3,600 141.732 (Note 2)	ø2.2	—	IP40	-40 to +60 °C	P.51
	Aperture angle 2° 	Tough FT-KV40	R2		STD (Note 2) 3,600 141.732 HYPR (Note 2) 3,600 141.732	3,600 141.732 (Note 2) 3,600 141.732 (Note 2) 1,200 47.244	2,200 86.614 (Note 2) 3,600 141.732 (Note 2)	ø2.5	±0.8°	IP30		
	Aperture angle 2° 	FT-KV40W	R1		STD (Note 2) 3,600 141.732 HYPR (Note 2) 3,600 141.732	3,600 141.732 (Note 2) 3,600 141.732 (Note 2) 3,100 122.047 940 37.008	2,200 86.614 (Note 2) 3,600 141.732 (Note 2)	ø2.5	±0.8°	IP30		
	Aperture angle 3° 1.5 x 2 	Tough FT-KV26	R2		STD 710 27.953 HYPR 2,500 98.425	1,600 62.992 1,200 47.244 440 17.323 160 6.299	135 5.315 560 22.047	ø1	X±1° Z±0.5°	IP30		

Retroreflective type

Type	Shape of fiber head (mm)	Model No.	Bending radius (mm)	Fiber cable length (m) Free-cut	Sensing range (mm in) (Note 1, 3)			Protection	Ambient temp.	Dimensions
					FX-500 series	U-LG LONG FAST H-SP	FX-101 (Upper value) FX-102 (Lower value)			
With polarizing filter	W5.2 x H9.5 x D16 W30 x H30 x D0.5	FR-Z50HW	R1	2 m	STD 100 to 990 3.937 to 38.976 HYPR 100 to 1,900 3.937 to 74.803	100 to 1,400 3.937 to 55.118 100 to 1,200 3.937 to 47.244 100 to 780 3.937 to 30.709 100 to 490 3.937 to 19.291	100 to 550 3.937 to 21.654 100 to 830 3.937 to 32.677	IP40	-25 to +55 °C	P.55
Wafer mapping	W7.5 x H2.2 x D11.2 Aperture angle 3° (emitter) W4 x H2 x D21.5	Tough FR-KZ22E	R2		STD 15 to 310 0.591 to 12.205 HYPR 15 to 570 0.591 to 22.441	15 to 460 0.591 to 18.110 15 to 410 0.591 to 16.142 15 to 220 0.591 to 8.661 15 to 100 0.591 to 3.937	15 to 200 0.591 to 7.874 15 to 360 0.591 to 14.173	IP30	-40 to +60 °C	
Narrow beam Top sensing	W5.2 x H9.5 x D21 W10.6 x H28 x D10.1	Tough FR-KZ50H	R2		STD 20 to 300 0.787 to 11.811 HYPR 20 to 1,000 0.787 to 39.370	20 to 800 0.787 to 31.496 20 to 400 0.787 to 15.748 20 to 200 0.787 to 7.874 20 to 200 0.787 to 7.874	20 to 200 0.787 to 7.874 20 to 350 0.787 to 13.780	IP30	-40 to +60 °C	
	W9.5 x H25 x D5.2 W28 x H10.6 x D10.1	Tough FR-KZ50E	R2		STD 20 to 300 0.787 to 11.811 HYPR 20 to 1,000 0.787 to 39.370	20 to 800 0.787 to 31.496 20 to 400 0.787 to 15.748 20 to 200 0.787 to 7.874 20 to 200 0.787 to 7.874	20 to 200 0.787 to 7.874 20 to 350 0.787 to 13.780	IP30	-40 to +60 °C	

Reflective type

Type	Shape of fiber head (mm)	Model No.	Bending radius (mm)	Fiber cable length (m) Free-cut	Sensing range (mm in) (Note1)			Protection	Ambient temp.	Dimensions
					FX-500 series	U-LG LONG FAST H-SP	FX-101 (Upper value) FX-102 (Lower value)			
Long range	W5.2 x H9.5 x D16	FD-Z50HW	R1	2 m	STD 10 to 650 0.394 to 25.591 HYPR 10 to 2,500 0.394 to 98.425	10 to 1,100 0.394 to 43.307 10 to 1,000 0.394 to 39.370 10 to 410 0.394 to 16.142 15 to 130 0.591 to 5.118	10 to 200 0.394 to 7.874 10 to 530 0.394 to 20.866	IP40	-40 to +60 °C	P.65

Notes: 1) Note that the sensing range of the free-cut type fiber may be reduced by 20 % max. depending upon how the fiber is cut.

2) The fiber cable length practically limits the sensing range.

3) The sensing range is the possible setting range for the attached reflector. The fiber can detect an object less than setting range for the reflector. Refer to P.27 or 38 for the sensing range when FR-Z50HW is used in combination with a reflector (optional).

Tough : Refers to a fiber which possesses both unbreakable (bending radius: R10 mm R0.394 in, reciprocating bending: 180°) and more flexible (bending radius: R4 mm R0.157 in or less) features.

Wide Beam

■ Senses a workpiece with indefinite shape or position in the wide beam without missing. It can also be used to discriminate shape.

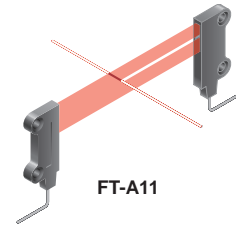

Applications

- Sensing tiny moving objects
- Inspecting screw height
- Control the amount of meandering
- Confirming presence of slit mask

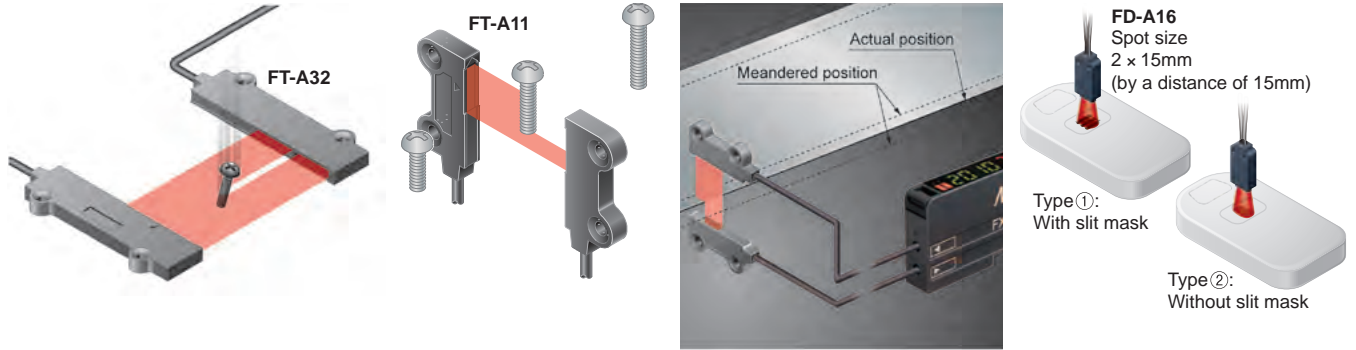

LIST OF FIBERS

Thru-beam type (one pair set)

Type	Shape of fiber head (mm)	Model No.	Bending radius (mm)	Fiber cable length ✂: Free-cut	Sensing range (mm in) (Note 1)			Beam axis dia. (mm)	Protection	Ambient temp.	Dimensions
					FX-500 series	U-LG LONG FAST H-SP	FX-101 (Upper value) FX-102 (Lower value)				
Wide beam	<p>Sensing width 32mm W5 x H69 x D20</p>	Tough FT-A32	R2 Bending durability	2 m	STD (Note 2) 3,600 141.732	3,600 141.732 (Note 2)	3,600 141.732 (Note 2)	3.2 x 32	IP40	-40 to +60 °C	P.49
		HYPR (Note 2) 3,600 141.732	3,600 141.732 (Note 2) 2,100 82.677								
	Allows flexible wiring	FT-A32W	R1		STD (Note 2) 3,600 141.732	3,600 141.732 (Note 2)	3,600 141.732 (Note 2)				
	HYPR (Note 2) 3,600 141.732	3,600 141.732 (Note 2) 3,000 118.110									
Wide beam	<p>Sensing width 11mm W4.2 x H31 x D13.5</p>	Tough FT-A11	R2 Bending durability	2 m	STD (Note 2) 3,600 141.732	3,600 141.732 (Note 2)	3,600 141.732 (Note 2)	2.2 x 11	IP40	-40 to +70 °C	P.49
		HYPR (Note 2) 3,600 141.732	3,600 141.732 (Note 2) 1,100 43.307								
Allows flexible wiring	FT-A11W	R1	STD (Note 2) 3,600 141.732		3,600 141.732 (Note 2)	1,900 74.803					
HYPR (Note 2) 3,600 141.732	3,600 141.732 (Note 2) 3,400 133.858										
Array	<p>Sensing width 5.5mm W5 x H15 x D15</p>	Tough FT-AL05	R2 Bending durability	2 m	STD 860 33.858	1,550 61.024 1,500 59.055	250 9.843 660 25.984	0.25 x 5.5	IP40	-55 to +80 °C	P.49
HYPR 2,300 90.551	500 19.685 170 6.693										

Notes: 1) Note that the sensing range of the free-cut type fiber may be reduced by 20 % max. depending upon how the fiber is cut.
2) The fiber cable length practically limits the sensing range.

Reflective type

Type	Shape of fiber head (mm)	Model No.	Bending radius (mm)	Fiber cable length ✂: Free-cut	Sensing range (mm in) (Note 1, 2)			Protection	Ambient temp.	Dimensions
					FX-500 series	U-LG LONG FAST H-SP	FX-101 (Upper value) FX-102 (Lower value)			
Wide beam	<p>W7 x H15 x D30</p>	Tough FD-A16	R4 Bending durability	2 m	STD 200 7.874	200 7.874	120 4.724 240 9.449	IP40	-40 to +60 °C	P.58
HYPR Cannot use	140 5.512 75 2.953									
Array	<p>W5 x H20 x D20</p>	Tough FD-AL11	R2 Bending durability	2 m	STD 320 12.598	530 20.866 510 20.079	100 3.937 285 11.220	IP40	-55 to +80 °C	P.58
HYPR 670 26.378	180 7.087 50 1.969									

Notes: 1) Note that the sensing range of the free-cut type fiber may be reduced by 20 % max. depending upon how the fiber is cut.
2) The sensing range is specified for white non-glossy paper.

Tough : Refers to a fiber which possesses both unbreakable (bending radius: R10 mm R0.394 in, reciprocating bending: 180°) and more flexible (bending radius: R4 mm R0.157 in or less) features.

New product introduction
Tough Fiber

Fiber Selection Guide

Model

Choose by shape/application

How to read Model No.

Earlier models comparison table

Fibers

Super Quality

Threaded Type

Square Head Type

Cylindrical Type

Sleeve

Flat Type

Small Type

Small Spot

Narrow Beam

Wide Beam

Convergent Reflective Type

Retroreflective Type

Chemical / Oil-resistant

Heat-resistant

Vacuum-resistant

Liquid Leak / Liquid Detection

Fiber Options

Semi-custom fibers

Fiber Dimensions

Thru-beam Type

Retroreflective Type

Reflective Type

Others

Amplifiers

FX-500 series

FX-100 series

INDEX

Convergent Reflective Type

It is a fiber in which the sensing distance is limited to a specific range so it is not easily affected by the background. It is effective when a workpiece is accumulated or when the background is near.

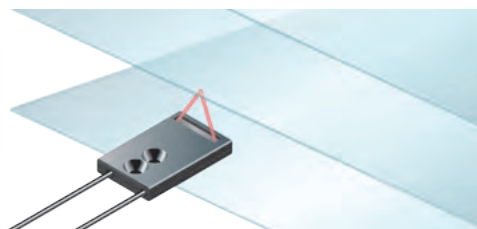

Applications

Detecting a passing glass

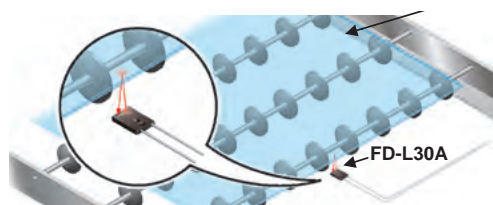

LCD transportation

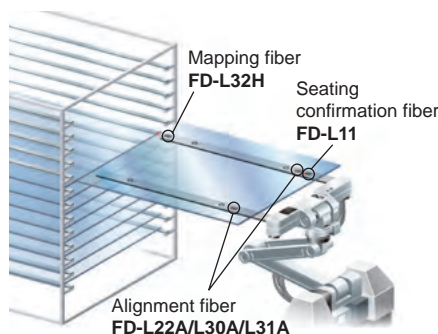

Mounting in handling arms

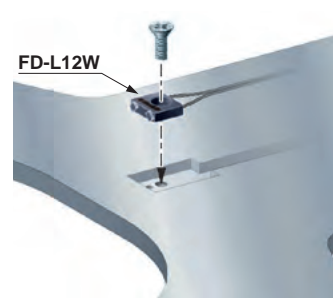

LIST OF FIBERS

Reflective type

Type	Shape of fiber head (mm)	Model No.	Bending radius (mm)	Fiber cable length (m)	Sensing range (mm in) (Note 1, 2)			Protection	Ambient temp.	Dimensions
					FX-500 series	U-LG LONG FAST H-SP	FX-101 (Upper value) FX-102 (Lower value)			
Glass substrate detection	Mapping W25 x H7.3 x D30	FD-L32H	R4 Bending durability	 4 m	STD 0 to 56 0 to 2.205 HYPR 0 to 110 0 to 4.331	0 to 87 0 to 3.425 0 to 74 0 to 2.913 1 to 38 0.039 to 1.496 Cannot use	16 to 30 0.630 to 1.181 0 to 50 0 to 1.969	IP40	-40 to +60 °C	P.63
	Alignment W20 x H29 x D3.8	Tough FD-L30A	R2 Bending durability	3 m	STD 0 to 43 0 to 1.693 HYPR 0 to 43 0 to 1.693	0 to 43 0 to 1.693 0 to 42 0 to 1.654 0 to 29 0 to 1.142	0 to 40 0 to 1.575 0 to 50 0 to 1.969			
	Alignment W23.5 x H29 x D4.5	Tough FD-L31A	R4 Bending durability	3 m	STD 4 to 33 0.157 to 1.299 HYPR 3 to 35 0.118 to 1.378	4 to 33 0.157 to 1.299 4 to 33 0.157 to 1.299 4 to 32 0.157 to 1.260 5 to 25 0.197 to 0.984	5 to 30 0.197 to 1.181 4 to 33 0.157 to 1.299			
	Alignment W17 x H29 x D3.8	Tough FD-L22A	R2 Bending durability	2 m	STD 0 to 24 0 to 0.945 HYPR 0 to 31 0 to 1.220	0 to 28 0 to 1.102 0 to 27 0 to 1.063 0 to 24 0 to 0.945 0 to 18 0 to 0.709	0 to 19 0 to 0.748 0 to 25 0 to 0.984			
	Seating confirmation W18 x H29 x D3.8	Tough FD-L23	R2 Bending durability	3 m	STD 0 to 29 0 to 1.142 HYPR 0 to 30 0 to 1.181	0 to 30 0 to 1.181 0 to 30 0 to 1.181 0 to 28 0 to 1.102 1.5 to 24 0.059 to 0.945	0 to 28 0 to 1.102 0 to 30 0 to 1.181			
	Seating confirmation W12 x H19 x D3	Tough FD-L11	R4 Bending durability	3 m	STD 0 to 9.5 0 to 0.374 HYPR 0 to 11.5 0 to 0.453	0 to 10.5 0 to 0.413 0 to 10 0 to 0.394 0 to 9 0 to 0.354 0 to 8 0 to 0.315	0 to 8 0 to 0.315 0 to 9 0 to 0.354			
	Seating confirmation W12 x H19 x D3	Tough FD-L10	R2 Bending durability	3 m	STD 0 to 5 0 to 0.197 HYPR 0 to 6 0 to 0.236	0 to 5.5 0 to 0.217 0 to 5.5 0 to 0.217 0 to 4.5 0 to 0.177 0 to 4 0 to 0.157	0 to 4.5 0 to 0.177 0 to 5.5 0 to 0.217			
	Alignment W24 x H21 x D4	Tough FD-L21	R2 Bending durability	2 m	STD 1.5 to 16 0.059 to 0.630 HYPR 1 to 19 0.039 to 0.748	1 to 18 0.039 to 0.709 1 to 18 0.039 to 0.709 2 to 15 0.079 to 0.591 3 to 12 0.118 to 0.472	3 to 15 0.118 to 0.591 1.5 to 16 0.059 to 0.630			
	Alignment W24 x H21 x D4	FD-L21W	R1 Bending durability	2 m	STD 3 to 14 0.118 to 0.551 HYPR 1.5 to 15 0.059 to 0.591	2 to 15 0.079 to 0.591 2 to 15 0.079 to 0.591 4 to 14 0.157 to 0.551 6.5 to 10 0.256 to 0.394	7 to 12 0.276 to 0.472 3 to 14 0.118 to 0.551			
	General purpose W6 x H18 x D14	Tough FD-L20H	R2 Bending durability	2 m	STD 23 0.906 HYPR 45 1.772	35 1.378 32 1.260 2 to 15 0.079 to 0.591 5 to 9 0.197 to 0.354	5 to 15 0.197 to 0.591 1 to 30 0.039 to 1.181			
Ultra-small W7.2 x H7.5 x D2	FD-L12W	R1 Bending durability	1 m	STD 8 0.315 HYPR 14 0.551	12.5 0.492 12 0.472 0.5 to 7 0.020 to 0.276 0.5 to 4 0.020 to 0.157	1 to 4.5 0.039 to 0.177 0.5 to 7 0.020 to 0.276	IP30	-40 to +60 °C		

Notes: 1) The sensing range is specified for transparent glass 100 × 100 × t0.7 mm 3.937 × 3.937 × t0.028 in (FD-L32H: R edge, FD-L21 and FD-L21W: t2 mm 0.079 in) (FD-L20H: white non-glossy paper, FD-L10: silicon wafers 100 × 100 mm 3.937 × 3.937 in).
2) Note that the sensing range of the free-cut type fiber may be reduced by 20 % max. depending upon how the fiber is cut.

Tough : Refers to a fiber which possesses both unbreakable (bending radius: R10 mm R0.394 in, reciprocating bending: 180°) and more flexible (bending radius: R4 mm R0.157 in or less) features.

Retroreflective Type

Compared with the thru-beam type, it is easier to arrange the fibers since one side is a reflector. Sensing transparent objects is also its advantage.



Applications

Detecting transparent film

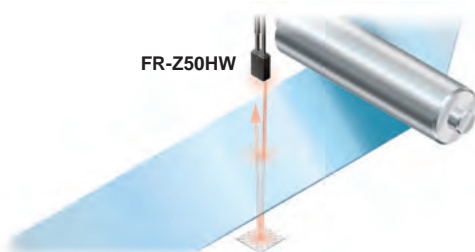

Detecting wafers



Detecting transparent seals on transparent sheet

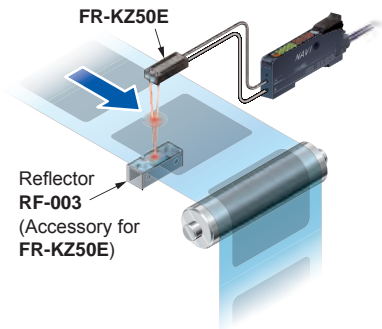

LIST OF FIBERS

Retroreflective type

Type	Shape of fiber head (mm)	Model No.	Bending radius (mm)	Fiber cable length Free-cut	Sensing range (mm in) (Note 1, 2)			Protection	Ambient temp.	Dimensions
					FX-500 series	U-LG LONG FAST H-SP	FX-101 (Upper value) FX-102 (Lower value)			
With polarizing filters	W5.2 x H9.5 x D16 W30 x H30 x D0.5	FR-Z50HW	R1	2 m	STD	100 to 1,400 3.937 to 55.118	100 to 550	IP40	-25 to +55 °C	P.55
					HYPR	100 to 1,200 3.937 to 47.244 100 to 780 3.937 to 30.709 100 to 490 3.937 to 19.291	3.937 to 21.654 100 to 830 3.937 to 32.677			
Wafer mapping	W7.5 x H2.2 x D11.2 W4 x H2 x D21.5	Tough FR-KZ22E	R2	2 m	STD	15 to 460 0.591 to 18.110 15 to 410 0.591 to 16.142 15 to 220 0.591 to 8.661 15 to 100 0.591 to 3.937	15 to 200 0.591 to 7.874 15 to 360 0.591 to 14.173	IP30	-40 to +60 °C	P.55
Narrow beam Top sensing	W5.2 x H9.5 x D21 W10.6 x H28 x D10.1 W9.5 x H25 x D5.2 W28 x H10.6 x D10.1	Tough FR-KZ50H FR-KZ50E	Bending durability	2 m	STD	20 to 800 0.787 to 31.496 20 to 400 0.787 to 15.748 20 to 200 0.787 to 7.874 20 to 200 0.787 to 7.874	20 to 200 0.787 to 7.874 20 to 350 0.787 to 13.780			

Notes: 1) Note that the sensing range of the free-cut type fiber may be reduced by 20 % max. depending upon how the fiber is cut.
2) The sensing range is the possible setting range for the attached reflector. The fiber can detect an object less than setting range for the reflector.

Sensing range when FR-Z50HW is used in combination with a reflector (optional)

Reflector model No.	Sensing range (mm in)							
	FX-500 series						FX-101	FX-102
	HYPR	U-LG	LONG	STD	FAST	H-SP		
RF-230	100 to 19,000 3.937 to 748.030	100 to 8,000 3.937 to 314.960	100 to 5,000 3.937 to 196.850	100 to 3,600 3.937 to 141.732	100 to 2,900 3.937 to 114.173	100 to 1,400 3.937 to 55.118	100 to 2,400 3.937 to 94.488	100 to 5,000 3.937 to 196.850
RF-220	100 to 8,000 3.937 to 314.960	100 to 4,700 3.937 to 185.039	100 to 3,500 3.937 to 137.795	100 to 3,000 3.937 to 118.110	100 to 1,800 3.937 to 70.866	100 to 830 3.937 to 32.677	100 to 1,300 3.937 to 51.181	100 to 2,600 3.937 to 102.362
RF-210	100 to 5,500 3.937 to 216.535	100 to 2,700 3.937 to 106.299	100 to 2,400 3.937 to 94.488	100 to 1,500 3.937 to 59.055	100 to 1,200 3.937 to 47.244	100 to 530 3.937 to 20.866	100 to 980 3.937 to 38.583	100 to 1,300 3.937 to 51.181

Note: The sensing range of retroreflective type is the possible setting range for the attached reflector. The fiber can detect an object less than 100 mm 3.937 in. However, note that if there are any white or highly-reflective surfaces near the fiber head, reflected incident light may affect the fiber head. If this occurs, adjust the threshold value of the amplifier unit before use.

FIBER OPTION

Reflectors (for FR-Z50HW) ▶ P.45



Tough : Refers to a fiber which possesses both unbreakable (bending radius: R10 mm R0.394 in, reciprocating bending: 180°) and more flexible (bending radius: R4 mm R0.157 in or less) features.

New product introduction
Tough Fiber

Fiber Selection Guide

Model

Choose by shape/application

How to read Model No.

Earlier models comparison table

Fibers

Super Quality

Threaded Type

Square Head Type

Cylindrical Type

Sleeve

Flat Type

Small Spot

Narrow Beam

Wide Beam

Convergent Reflective Type

Retroreflective Type

Chemical / Oil-resistant

Heat-resistant

Vacuum-resistant

Liquid Leak / Liquid Detection

Fiber Options

Semi-custom fibers

Fiber Dimensions

Thru-beam Type

Retroreflective Type

Reflective Type

Others

Amplifiers

FX-500 series

FX-100 series

INDEX

Chemical / Oil-resistant



- With the case and fiber sheath made of PFA, the fiber can be used with various types of chemical liquids.
- The fiber core will not harden or break, even in environments where oil is present.

Full-protection type

FT-R60Y (Square head type M6 / thru-beam type)

High environmental resistance

The head, nut, and washer are made from rust-resistant SUS304. The unbreakable tough fiber with high durability is covered in a fluorine resin tube. The fiber head is also covered with a fluorine resin component, achieving a high level of environmental resistance.

Less susceptibility to oil adhesion thanks to fluorine resin

Fibers deliver stable detection, since the sensing part is sealed with fluorine resin, which does not allow oil penetration. Additionally, the detection part features a convex design made of fluorine resin, achieving lower friction than glass.

Resistant to oil and coolant

The fiber head and fiber cable are connected by the “fastening and caulking” method without using adhesives. This method eliminates concerns that adhesives will absorb moisture in high-humidity environments and damage the fiber. The enclosure achieves IP68G protection, so the fiber can be installed around metal processing machines shrouded in the oil mist.

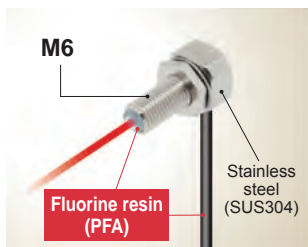
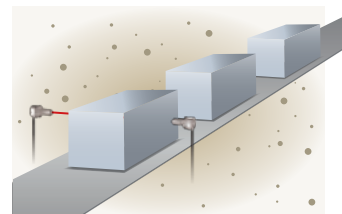

Test oil	Product
Lubricating oil	Velocite Oil No. 3
Non-water-soluble cutting oil	Yushiron Cut Abas KZ201
	Yushiron Cut UH75
Water-soluble cutting oil	Syntilo 9954 (10% diluted)
	Yushiroken S50N (2% diluted)
Alcohol-based neutral detergent	Super Teepol

*Yushiron and Yushiroken are registered trademarks of Yushiro Chemical Industry Co., Ltd.

Cable-protection type

FT-R44Y / FD-R61Y

FT-R44Y (Square head type M4 / thru-beam type)

FD-R61Y (Square head type M6 / reflective type)

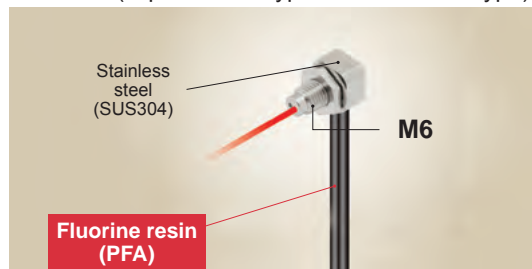
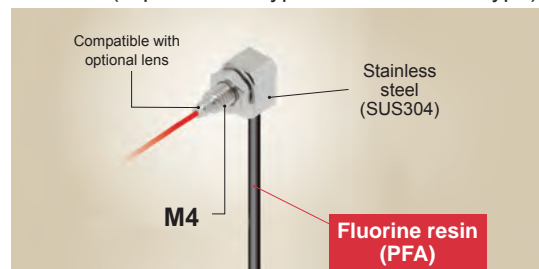

Full-protection type

FD-S60Y (Cylindrical type / reflective type) Metal-free

Metal-free design

Since no metal components are used, there is no need to worry about metal contamination, even if the protective tube is damaged. It is ideal for use in applications such as semiconductor front-end equipment where a clean environment is required.

Detection in long range and narrow view

A built-in lens achieves narrow-view detection with an aperture angle of 30 degrees.

Improved tip flexibility

The protective tube features a bending radius of R30 mm **R1.181 in**, which improved the cable arrangement compared to previous (R40 mm **R1.575 in**) designs.

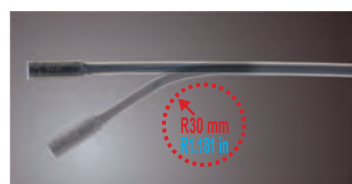
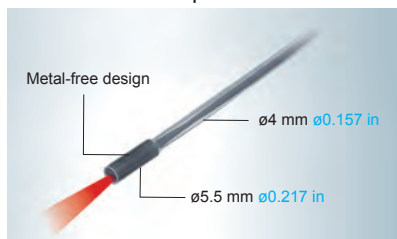

LIST OF FIBERS

Thru-beam type (one pair set)

Type	Shape of fiber head (mm)	Model No.	Bending radius (mm)	Fiber cable length (mm): Free-cut	Sensing range (mm in) (Note 1)			Beam axis dia. (mm)	Protection	Ambient temp.	Dimensions	
					FX-500 series	U-LG LONG FAST H-SP	FX-101 (Upper value) FX-102 (Lower value)					
Oil-resistant	Square head type M4 Cable-protection type Compatible with lens W7×H9.5×D15.5	Tough NEW FT-R44Y	R4	2 m	STD 720 28.346 HYPR 3,000 118.110	1,600 62.992 1,100 43.307 430 16.929 130 5.118	210 8.268 640 25.197	ø1	IP67 (Note 4)	-55 to +80 °C	P.52	
	Square head type M6 Full-protection type W10×H11×D21.2	Tough NEW FT-R60Y	R4	2 m	STD 2,100 82.677 HYPR (Note 2) 3,600 141.732	3,600 141.732 (Note 2) 3,600 141.732 (Note 2) 1,260 49.606 400 15.748	690 27.165 1,890 74.409	ø3.5		-55 to +80 °C		
Chemical-resistant	Flat type Easy mounting • Rectangular head SEMI S2 compliant W7 × H15 × D13 Metal-free	Tough FT-Z802Y	R4	2 m	STD 3,100 122.047 HYPR (Note 2) 3,600 141.732	3,600 141.732 (Note 2) 3,600 141.732 (Note 2) 1,900 74.803 470 18.504	520 20.472 3,100 122.047			0 to +60 °C	P.54	
	Cylindrical type	Heat-resistant 115 °C Metal-free ø5.5 -(25)-	FT-HL80Y	R30	2 m (Note 3)	STD (Note 2) 3,600 141.732 HYPR (Note 2) 3,600 141.732	3,600 141.732 (Note 2) 3,600 141.732 (Note 2) 2,300 90.551 740 29.134	990 38.976 2,340 92.126	ø3.7	IP68G	-40 to +115 °C	P.50
		Metal-free ø5.5 -(25)-	FT-L80Y			STD (Note 2) 3,600 141.732 HYPR (Note 2) 3,600 141.732	3,600 141.732 (Note 2) 3,600 141.732 (Note 2) 2,800 110.236 920 36.220	1,100 43.307 2,600 102.362				P.51
		Side-view Metal-free ø5.5 -(25)-	FT-V80Y			STD 1,300 51.181 HYPR (Note 2) 3,600 141.732	2,800 110.236 2,200 86.614 800 31.496 240 9.449	340 13.386 800 31.496				ø2.8

Notes: 1) Note that the sensing range of the free-cut type fiber may be reduced by 20 % max. depending upon how the fiber is cut.
 2) The fiber cable length practically limits the sensing range.
 3) The allowable cutting range is 500 mm 19.685 in from the end that the amplifier inserted.
 4) The fiber part is oil-resistant.

Reflective type

Type	Shape of fiber head (mm)	Model No.	Bending radius (mm)	Fiber cable length (mm): Free-cut	Sensing range (mm in) (Note 1, 2)			Beam axis dia. (mm)	Protection	Ambient temp.	Dimensions
					FX-500 series	U-LG LONG FAST H-SP	FX-101 (Upper value) FX-102 (Lower value)				
Oil-resistant	Square head type M6 Cable-protection type W10×H11×D15.5	Tough NEW FD-R61Y	R4	2 m	STD 280 11.024 HYPR 990 38.976	610 24.016 435 17.126 160 6.299 50 1.969	85 3.346 185 7.283	—	IP67 (Note 3)	-55 to +80 °C	P.63
Chemical-resistant	Cylindrical type Metal-free ø5.5 -(16)-	Tough NEW FD-S60Y	R4	2 m (Note 4)	STD 320 12.598 HYPR 600 23.622	590 23.228 420 16.535 200 7.874 75 2.953	140 5.512 300 11.811	—	IP68G	-40 to +70 °C	P.64

Notes: 1) Note that the sensing range of the free-cut type fiber may be reduced by 20 % max. depending on how the fiber is cut.
 2) The sensing range is specified for white, non-glossy paper.
 3) The fiber part is oil-resistant.
 4) The allowable cutting range is 500 mm 19.685 in from the end that is inserted to the amplifier.

Applications

Detecting wafer cassette in cleaning tank

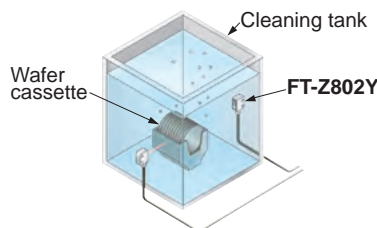

Sensing a wafer in corrosive environment

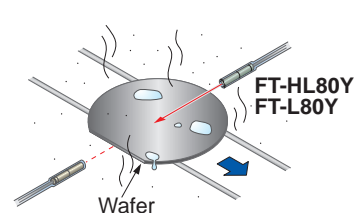

Detecting a container at a chemical Piller

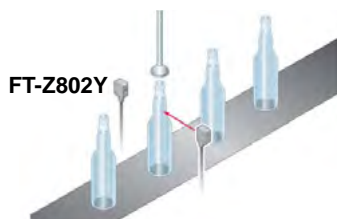

Tough : Refers to a fiber which possesses both unbreakable (bending radius: R10 mm R0.394 in, reciprocating bending: 180°) and more flexible (bending radius: R4 mm R0.157 in or less) features.

New product introduction

Tough Fiber

Fiber Selection Guide

Model

Choose by shape/application

How to read Model No.

Earlier models comparison table

Fibers

Super Quality

Threaded Type

Square Head Type

Cylindrical Type

Sleeve

Flat Type

Small Spot

Narrow Beam

Wide Beam

Convergent Reflective Type

Retroreflective Type

Chemical / Oil-resistant

Heat-resistant

Vacuum-resistant

Liquid Leak / Liquid Detection

Fiber Options

Semi-custom fibers

Fiber Dimensions

Thru-beam Type

Retroreflective Type

Reflective Type

Others

Amplifiers

FX-500 series

FX-100 series

INDEX

Heat-resistant

- It can be used under environments of -60 to +350 °C
-76 to +662 °F.
- A joint type for wider workability is also available.



Applications

IC detection within a high temperature handler

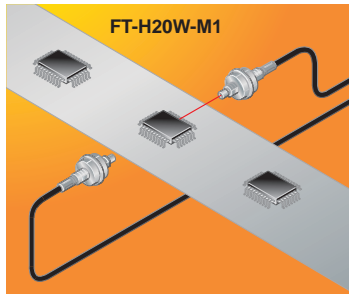

Detecting glass substrates

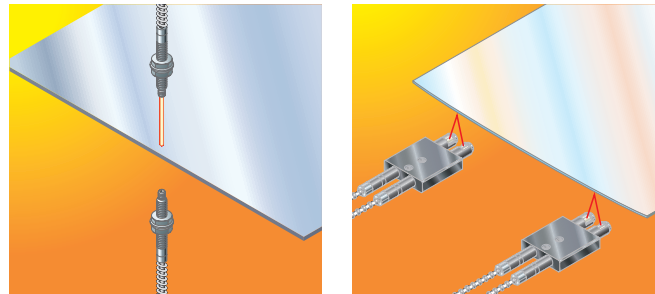

LIST OF FIBERS

Thru-beam type (one pair set)

Type	Heat-resistant temp.	Shape of fiber head (mm)	Model No.	Bending radius (mm)	Fiber cable length ✂️: Free-cut	Sensing range (mm in) (Note 1)			Beam axis dia. (mm)	Ambient temp.	Dimensions				
						FX-500 series	U-LG LONG FAST H-SP	FX-101 (Upper value) FX-102 (Lower value)							
Heat-resistant	350 °C	Lens mountable (FX-LE1/LE2/SV1) 	FT-H35-M2	R25	2 m	STD 430 16.929	880 34.646	170 6.693	ø1.2	-60 to +350 °C	P.50				
		Sleeve 60 mm 	FT-H35-M2S6	Fiber R25 Sleeve R10		HYPR 250 9.843	250 9.843	490 19.291				80 3.150			
	200 °C	Allows flexible wiring Lens mountable (FX-LE1/LE2/SV1) 	FT-H20W-M1	R10	1 m	STD 470 18.504	1,000 39.370	100 3.937	ø0.8	-60 to +200 °C					
		Lens mountable (FX-LE1/LE2/SV1) 	FT-H20-M1	R25		HYPR (Note 2) 1,600 62.992	840 33.071	300 11.811				300 11.811	90 3.543		
	130 °C	Lens mountable (FX-LE2 only) 	FT-H13-FM2	R25	✂️	2 m	STD 540 21.260	1,300 51.181	210 8.268	ø1.2		-60 to +130 °C			
				HYPR (Note 2) 1,600 62.992	960 37.795	330 12.992	540 21.260	110 4.331							
Heat-resistant (joint)	200 °C	Lens mountable (FX-LE1/LE2/SV1) 	FT-H20-J20-S (Note 5)	Heat-resistant side R18 (Note 4)	✂️	200 mm (Note 3)	STD 470 18.504	1,000 39.370	135 5.315	ø1.2	-60 to +200 °C				
			FT-H20-J30-S (Note 5)		✂️	300 mm (Note 3)						HYPR 1,600 62.992	790 31.102	300 11.811	420 16.535
			FT-H20-J50-S (Note 5)		✂️	500 mm (Note 3)						STD 600 23.622	1,300 51.181	150 5.906	500 19.685
		Side-view 	FT-H20-VJ50-S (Note 5)		✂️	800 mm (Note 3)						HYPR (Note 2) 2,100 82.677	980 38.583	120 4.724	
			FT-H20-VJ80-S (Note 5)		✂️										

- Notes: 1) Note that the sensing range of the free-cut type fiber may be reduced by 20 % max. depending upon how the fiber is cut.
 2) The fiber cable length practically limits the sensing range.
 3) Fiber length (fixed-length) for heat-resistant fiber side. Fiber length for ordinary temperature side is 2 m 6.562 ft (free-cut).
 4) Bending durable fiber R4 mm R0.157 in or more for ordinary temperature side.
 5) Heat-resistant joint fibers and ordinary-temperature fibers (FT-42) are sold as a set.

Heat-resistant joint fiber set contents

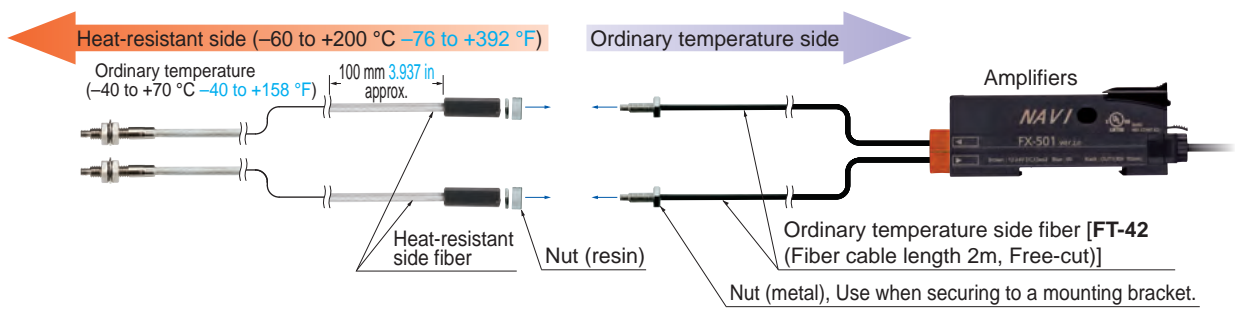

Model No. when ordering individually as spare parts

- Heat-resistant side fiber **one pair set**
FT-H20-J20, FT-H20-J30, FT-H20-J50, FT-H20-VJ50, FT-H20-VJ80
- Ordinary temperature side fiber **one pair set**
FT-42

LIST OF FIBERS

Reflective type

Type	Heat-resistant temp.	Shape of fiber head (mm)	Model No.	Bending radius (mm)	Fiber cable length ✂: Free-cut	Sensing range (mm in) (Note 1, 2)			Ambient temp.	Dimensions	
						FX-500 series	U-LG LONG FAST H-SP	FX-101 (Upper value) FX-102 (Lower value)			
Heat-resistant	350 °C	Coaxial M6 25	FD-H35-M2	R25	2 m	STD 260 10.236	540 21.260 460 18.110 150 5.906 45 1.772	75 2.953 280 11.024	-60 to +350 °C	P.61	
		Sleeve 60 mm M6 ø2.8 22	FD-H35-M2S6	Fiber R25		HYPR 720 28.346					
		Sleeve 90 mm M4 ø2.1 27	FD-H35-20S	Sleeve R10		STD 260 10.236 HYPR 840 33.071					
	200 °C	Coaxial M6 28	FD-H20-M1	R25	1 m	STD 330 12.992	550 21.654 500 19.685 200 7.874 55 2.165	120 4.724 300 11.811	-60 to +200 °C	P.60	
		Coaxial M4 27	FD-H20-21			STD 230 9.055 HYPR 770 30.315					
	130 °C	Coaxial M6 21	FD-H13-FM2	R25	2 m	STD 350 13.780 HYPR 880 34.646	640 25.197 600 23.622 200 7.874 65 2.559	100 3.937 280 11.024	-60 to +130 °C		
	Glass substrate detection convergent reflective	300 °C	W19 x H27 x D5	FD-H30-L32	R25	2 m	STD 17 0.669 HYPR 40 1.575	30 1.181 25 0.984 12 0.472	2 to 9 0.079 to 0.354 0 to 17	-60 to +300 °C	P.61
			W21 x H33.2 x D5	FD-H25-L43	STD 1.5 to 26 0.059 to 1.024 HYPR 1 to 31 0.039 to 1.220		1 to 28 0.039 to 1.102 1.5 to 24 0.059 to 0.945 2 to 18 0.079 to 0.709	0.157 to 0.630 4 to 23			
		250 °C	W21 x H34.5 x D5	FD-H25-L45	R25	3 m	STD 5 to 42 0.197 to 1.654 HYPR 4 to 43.5 0.157 to 1.713	4 to 43 0.157 to 1.693 4.5 to 43 0.177 to 1.693 5 to 40 0.197 to 1.575 6.5 to 34 0.256 to 1.339	7 to 35 0.276 to 1.378 7 to 38 0.276 to 1.496	-20 to +250 °C (Ordinary temp. side: -20 to +70 °C)	P.60
			W19 x H27 x D5	FD-H18-L31			STD 16 0.630 HYPR 60 2.362	32 1.260 24 0.945 13 0.512	0 to 10 0 to 0.394 0 to 25 0 to 0.984		

Notes: 1) The sensing range of reflective type is the value for white non-glossy paper (50 × 50 mm 1.969 × 1.969 in glass substrate for **FD-H30-L32**, **FD-H18-L31**, transparent glass 100 × 100 × 0.7 mm 3.937 × 3.937 × 0.028 in for **FD-H25-L43** and **FD-H25-L45**).
 2) Note that the sensing range of the free-cut type fiber may be reduced by 20 % max. depending upon how the fiber is cut.

FIBER OPTION

Lens (For thru-beam type fiber) ▶ P.42



New product introduction
 Tough Fiber
 Fiber Selection Guide
 Model
 Choose by shape/application
 How to read Model No.
 Earlier models comparison table

Fibers
 Super Quality
 Threaded Type
 Square Head Type
 Cylindrical Type
 Sleeve
 Flat Type
 Small Spot
 Narrow Beam
 Wide Beam
 Convergent Reflective Type
 Retroreflective Type
 Chemical / Oil-resistant
 Heat-resistant
 Vacuum-resistant
 Liquid Leak / Liquid Detection

Fiber Options

Semi-custom fibers

Fiber Dimensions
 Thru-beam Type
 Retroreflective Type
 Reflective Type

Others
 Amplifiers
 FX-500 series
 FX-100 series

INDEX

Vacuum-resistant

- Usable in high-temperatures of 300 °C 572 °F vacuum
- The leakage of **FV-BR1** is still less than a very slight $1.33 \times 10^{-10} \text{ Pa} \cdot \text{m}^3/\text{s} [\text{He}]$, so that it can be used in vacuums with confidence.

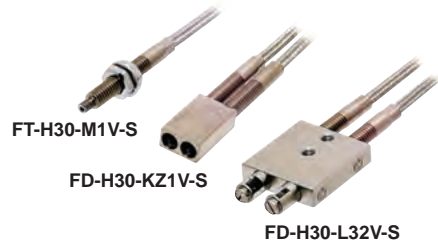

Applications

Detecting an FPD in vacuum chamber

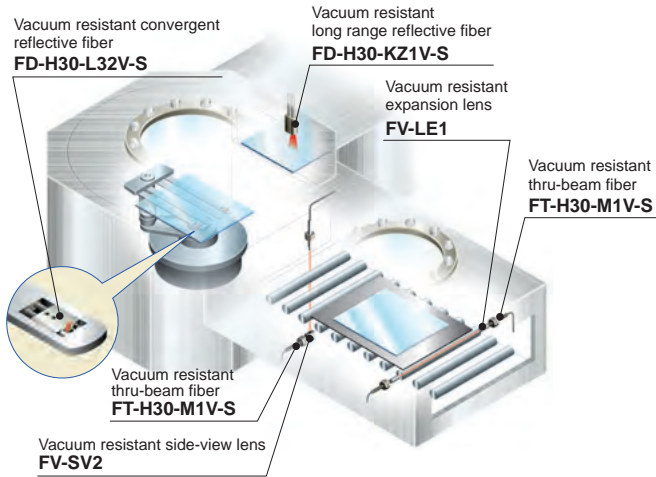

Highly resistant to repeated bending

Because it has a bending durability of over 100,000 times (R20 mm R0.787 in), it is highly resistant to repeated bending and is optimal for mounting on moving robot hand.



LIST OF FIBERS

Thru-beam type (one pair set)

Type	Shape of fiber head (mm)	Model No.	Bending radius (mm)	Fiber cable length	Sensing range (mm in)			Beam axis dia. (mm)	Ambient temp.	Dimensions
					FX-500 series	U-LG LONG FAST H-SP	FX-101 (Upper value) FX-102 (Lower value)			
Vacuum-resistant Thru-beam	300 °C Lens mountable (FV-LE1/SV2) M4 	FT-H30-M1V-S (Note)	R18	1 m	STD 270 10.630 HYPR 1,000 39.370	590 23.228 470 18.504 160 6.299 55 2.165	110 4.331 280 11.024	ø1.2	-30 to +300 °C	P.50

Note: Sold as a set comprising vacuum type fiber + photo-terminal (FV-BR1) + fiber at atmospheric side (FT-J8).

Reflective type

Type	Shape of fiber head (mm)	Model No.	Bending radius (mm)	Fiber cable length	Sensing range (mm in)(Note 2)			Ambient temp.	Dimensions
					FX-500 series	U-LG LONG FAST H-SP	FX-101 (Upper value) FX-102 (Lower value)		
Vacuum-resistant Reflective	300 °C, Rectangular head W9.5 x H5.2 x D15	FD-H30-KZ1V-S (Note 1)	R18	1 m	STD 20 to 200 0.787 to 7.874 HYPR 5 to 500 0.197 to 19.685	10 to 340 0.394 to 13.386 15 to 270 0.591 to 10.630 20 to 120 0.787 to 4.724 20 to 45 0.787 to 1.772	25 to 80 0.984 to 3.150 10 to 220 0.394 to 8.661	-30 to +300 °C	P.61
Vacuum-resistant Convergent reflective	300 °C, Glass substrate detection W19 x H5 x D27	FD-H30-L32V-S (Note 1)	R18	3 m	STD 8 0.315 HYPR 18 0.709	12 0.472 10 0.394 5.5 0.217 1.5 to 3 0.059 to 0.118	2.5 to 6.5 0.098 to 0.256 0 to 11 0 to 0.433	-30 to +300 °C	P.61

Notes: 1) Sold as a set comprising vacuum type fiber + photo-terminal (FV-BR1) + fiber at atmospheric side (FT-J8).
2) The sensing range of reflective type is the value for transparent glass 100 × 100 × 0.7 mm 3.937 × 3.937 × 0.028 in.

Vacuum-resistant fiber set contents

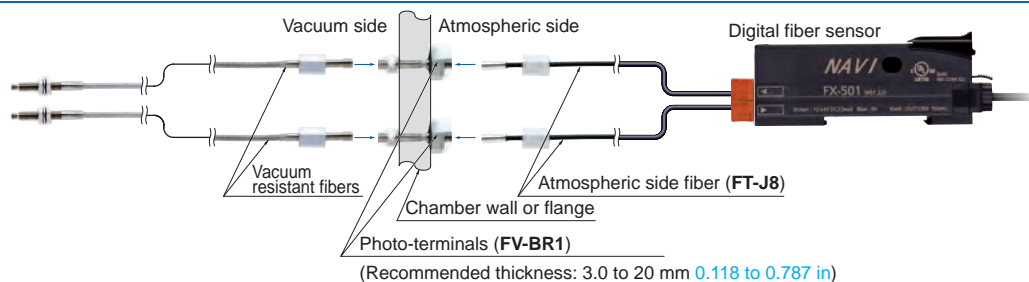

Model No. when ordering individually as spare parts

- Vacuum resistant fiber
FT-H30-M1V (one pair set)
FD-H30-KZ1V
FD-H30-L32V
- Photo-terminal
FV-BR1 (one pair set)
- Atmospheric side fiber
FT-J8 (one pair set)
- Mounting bracket for **FD-H30-KZ1V(-S)**
MS-FD-2

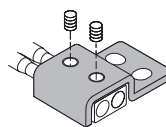

FIBER OPTIONS

Lens (For thru-beam fiber)

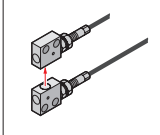
Designation	Model No.	Description																																								
For thru-beam type fiber	Vacuum resistant expansion lens (Note 1)	FV-LE1	 <p>Increases the sensing range 4 times or more.</p> <ul style="list-style-type: none"> • Ambient temperature: -60 to $+350$ °C -76 to $+662$ °F (Note 3) • Beam axis dia: $\varnothing 3.6$ mm $\varnothing 0.142$ in • Sensing range (mm in) [Lens on both sides] (Note 4) <table border="1"> <thead> <tr> <th rowspan="2">Amplifier</th> <th colspan="7">FX-500 series</th> <th colspan="2">FX-100 series</th> </tr> <tr> <th>Fiber</th> <th>Mode</th> <th>HYP</th> <th>U-LG</th> <th>LONG</th> <th>STD</th> <th>FAST</th> <th>H-SP</th> <th>FX-101</th> <th>FX-102</th> </tr> </thead> <tbody> <tr> <td rowspan="2">FT-H30-M1V-S</td> <td>3,600</td> <td>141.732</td> <td>141.732</td> <td>133.858</td> <td>59.055</td> <td>35.433</td> <td>14.567</td> <td>450</td> <td>1,600</td> </tr> <tr> <td>(Note 2)</td> <td>(Note 2)</td> <td>(Note 2)</td> <td>(Note 2)</td> <td>(Note 2)</td> <td>(Note 2)</td> <td>(Note 2)</td> <td>(Note 2)</td> <td>(Note 2)</td> </tr> </tbody> </table>	Amplifier	FX-500 series							FX-100 series		Fiber	Mode	HYP	U-LG	LONG	STD	FAST	H-SP	FX-101	FX-102	FT-H30-M1V-S	3,600	141.732	141.732	133.858	59.055	35.433	14.567	450	1,600	(Note 2)	(Note 2)	(Note 2)	(Note 2)	(Note 2)	(Note 2)	(Note 2)	(Note 2)	(Note 2)
	Amplifier	FX-500 series							FX-100 series																																	
Fiber		Mode	HYP	U-LG	LONG	STD	FAST	H-SP	FX-101	FX-102																																
FT-H30-M1V-S	3,600	141.732	141.732	133.858	59.055	35.433	14.567	450	1,600																																	
	(Note 2)	(Note 2)	(Note 2)	(Note 2)	(Note 2)	(Note 2)	(Note 2)	(Note 2)	(Note 2)																																	
Vacuum resistant side-view lens (Note 1)	FV-SV2	 <p>Beam axis is bent by 90°.</p> <ul style="list-style-type: none"> • Ambient temperature: -60 to $+300$ °C -76 to $+572$ °F (Note 3) • Beam axis dia: $\varnothing 3.7$ mm $\varnothing 0.146$ in • Sensing range (mm in) [Lens on both sides] (Note 4) <table border="1"> <thead> <tr> <th rowspan="2">Amplifier</th> <th colspan="7">FX-500 series</th> <th colspan="2">FX-100 series</th> </tr> <tr> <th>Fiber</th> <th>Mode</th> <th>HYP</th> <th>U-LG</th> <th>LONG</th> <th>STD</th> <th>FAST</th> <th>H-SP</th> <th>FX-101</th> <th>FX-102</th> </tr> </thead> <tbody> <tr> <td rowspan="2">FT-H30-M1V-S</td> <td>3,600</td> <td>141.732</td> <td>141.732</td> <td>133.858</td> <td>59.055</td> <td>35.433</td> <td>14.567</td> <td>450</td> <td>1,600</td> </tr> <tr> <td>(Note 2)</td> <td>(Note 2)</td> <td>(Note 2)</td> <td>(Note 2)</td> <td>(Note 2)</td> <td>(Note 2)</td> <td>(Note 2)</td> <td>(Note 2)</td> <td>(Note 2)</td> </tr> </tbody> </table>	Amplifier	FX-500 series							FX-100 series		Fiber	Mode	HYP	U-LG	LONG	STD	FAST	H-SP	FX-101	FX-102	FT-H30-M1V-S	3,600	141.732	141.732	133.858	59.055	35.433	14.567	450	1,600	(Note 2)	(Note 2)	(Note 2)	(Note 2)	(Note 2)	(Note 2)	(Note 2)	(Note 2)	(Note 2)	
Amplifier	FX-500 series							FX-100 series																																		
	Fiber	Mode	HYP	U-LG	LONG	STD	FAST	H-SP	FX-101	FX-102																																
FT-H30-M1V-S	3,600	141.732	141.732	133.858	59.055	35.433	14.567	450	1,600																																	
	(Note 2)	(Note 2)	(Note 2)	(Note 2)	(Note 2)	(Note 2)	(Note 2)	(Note 2)	(Note 2)																																	

- Notes: 1) Be careful when installing the thru-beam type fiber equipped with the lens, as the beam envelope becomes narrow and alignment is difficult.
 2) The fiber cable length practically limits the sensing range.
 3) Refer to previous page for the ambient temperature of fibers to be used in combination.
 4) The fiber cable length for the **FT-H30-M1V-S** is 1 m **3.281 ft**. The sensing ranges in HYP, U-LG and LONG of **FX-500** series, in **FX-102** take into account the length of the **FT-J8** atmospheric side fiber.

Liquid Leak / Liquid Detection

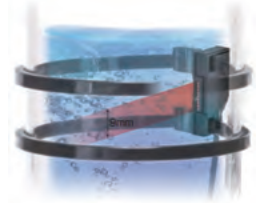

It corresponds to various liquid events, from the contact (wetted) type to the pipe mounting type, and up to leak detection.

For detecting the upper limit of liquid surface level, sensor that receives beam when “liquid is absent” is recommended.

The sensor will turn OFF during abnormal conditions (excess fluid, fiber disconnection, etc.)!
Liquid absent: Beam received (Output ON)
Liquid present / fiber is cutoff: Beam not received (Output OFF)

FD-FA93 Strong against air bubbles

Applicable pipe: Transparent pipe, Outer diameter $\varnothing 8$ mm
 $\varnothing 0.315$ in or more
(When used with the tying bands: $\varnothing 8$ to $\varnothing 80$ mm $\varnothing 0.315$ to $\varnothing 3.150$ in)

FD-F41

Standard type



FD-F4

For 1 mm 0.039 in thick pipes manufactured by PFA

For detecting the lower limit of liquid surface level, sensor that receives beam when “liquid is present” is recommended.

The sensor will turn OFF during abnormal conditions (insufficient liquid, fiber disconnection, etc.) !
Liquid present: Beam received (Output ON)
Liquid absent / fiber is cutoff: Beam not received (Output OFF)

FT-F93 Thru-beam



Full-protection type

FD-HF40Y / FD-F41Y (Liquid level sensing) Metal-free

Small diameter type

($\varnothing 4$ mm $\varnothing 0.157$ in)
Bends easily with its small bending radius, protective tube is cuttable and extendable

FD-HF40Y

R10 mm R0.394 in

Sheath: Polyethylene

R20 mm R0.787 in

$\varnothing 4$ mm $\varnothing 0.157$ in protective tube (fluorine resin)

Heat-resistant
 $+105$ °C $+221$ °F

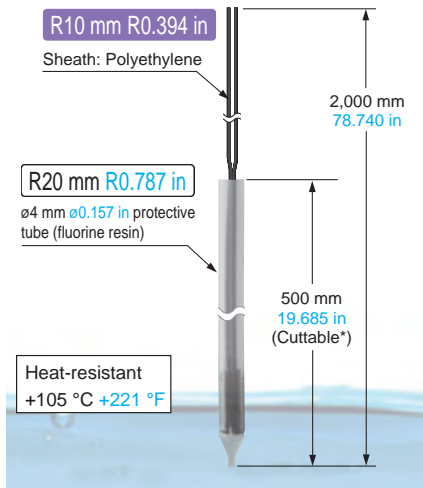

FD-F41Y

R10 mm R0.394 in

Primary sheath: Polyethylene
Secondary sheath: Fluorine resin

R20 mm R0.787 in

$\varnothing 4$ mm $\varnothing 0.157$ in protective tube (fluorine resin)

Heat-resistant
 $+70$ °C $+158$ °F

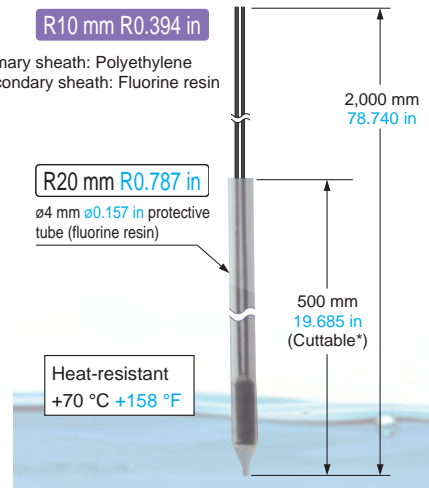

* The range of 50 mm 1.969 in from the fiber tip cannot be cut. Also, fiber length can be extended using **MS-FX-02Y** (optional).

Full-protection type

FD-F71 (Liquid level sensing) SEMI S2 compliant

Detect chemical leaks in semiconductor and LCD manufacturing processes.

Compact, space-saving

Side-mountable fiber head as slim as 10 mm 0.394 in is good to use in confined spaces.

Ideal for use with chemicals and volatile materials

This fiber type sensor is safer to use with volatile materials (SEMI S2 compliant). The fluorine resin fiber head makes it ideal for use with chemicals.



LIST OF FIBERS

Reflective type / Thru-beam type

Type	Shape of fiber head (mm)	Model No.	Bending radius (mm)	Fiber cable length Free-cut	Description		Protection	Ambient temp.	Dimensions					
					FX-500 series (STD mode)	FX-101 FX-102								
Contact type	Liquid level sensing 	Heat resistant 125 °C Fluorine resin coating ø6 FD-F8Y	Protective tube R40 Fiber R15	2 m (Note 1)	ø6 mm ø0.236 in Protective tube: Fluorine resin, length 1,000 mm 39.370 in (not cuttable) Liquid surface not contacted: Beam received, Liquid surface contacted: Beam not received		IP68	-40 to +125 °C	P.59					
		Heat resistant 105 °C Fluorine resin coating Metal-free ø4 FD-HF40Y (Note 2)	Protective tube R20 Fiber R10							2 m	ø4 mm ø0.157 in Protective tube: Fluorine resin, length 500 mm 19.685 in (cuttable) Liquid surface not contacted: Beam received, Liquid surface contacted: Beam not received	IP68G	-40 to +105 °C	P.61
		Heat resistant 70 °C Fluorine resin coating throughout the fiber Metal-free ø4 FD-F41Y (Note 2)												
Liquid leak detection		Tough FD-F71	R4 Bending durability	5 m	Liquid leak detection Leak absent: Beam received, Leak present: Beam interrupted Compatible amplifier: FX500 series only		IP67	-20 to +60 °C						
Pipe-mountable type	Liquid level sensing	Standard W25 x H13 x D20 FD-F41	R10	2 m	Applicable pipe diameter: Outer dia. ø6 to ø26 mm ø0.236 to ø1.024 in transparent pipe [PVC (vinyl chloride), fluorine resin, polycarbonate, acrylic, glass, wall thickness 1 to 3 mm 0.039 to 0.118 in] Liquid absent: Beam received, Liquid present: Beam not received			-40 to +100 °C	P.59					
		For 1 mm thick PFA pipe W25 x H13 x D20 FD-F4								Applicable pipe diameter: Outer dia. ø6 to ø26 mm ø0.236 to ø1.024 in transparent pipe [PFA (fluorine resin) or equivalently transparent pipe, wall thickness 1 mm 0.039 in] Liquid absent: Beam received, Liquid present: Beam not received				
	Liquid sensing	Mountable on pipe-array fiber W6.5 x H28.3 x D17 Tough FD-FA93	R4 Bending durability		Applicable pipe diameter: Outer dia. ø8 mm ø0.315 in or more transparent pipe (When used with the tying bands: ø8 to ø80 mm ø0.315 to ø3.150 in) [PFA (fluorine resin), including translucent] Liquid absent: Beam received, Liquid present: Beam not received	IP40	-40 to +70 °C							
		SEMI S2 compliant W23 x H20 x D17 Tough FT-F93	Protective tube R20 Fiber R2 Bending durability		Applicable pipe diameter: Outer dia. ø3 to ø10 mm ø0.118 to ø0.394 in transparent pipe [PFA (fluorine resin) or equivalently transparent pipe, wall thickness 0.3 to 1 mm 0.012 to 0.039 in] Liquid absent: Beam not received, Liquid present: Beam received Compatible amplifier: FX500 series only			-40 to +60 °C	P.49					

Notes: 1) The allowable cutting range is 1,000 mm **39.370 in** from the end that the amplifier inserted.
2) Liquid inflow prevention joint, protective tube extension joint, fiber mounting joint is available.

Accessories for additional supply

- **MS-FD-F7-1**

(SUS mounting bracket for **FD-F71**)

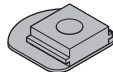

- **MS-FD-F7-2**

(PVC mounting bracket for **FD-F71**)

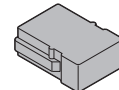

FIBER OPTIONS

Designation	Model No.	Description	
Liquid inflow prevention joint (Note)	MS-FX-01Y	Applicable fibers FD-HF40Y FD-F41Y	This joint suppresses false operations due to liquid slip-in from the top of the protective tube.
Protective tube extension joint (Note)	MS-FX-02Y		The protective tube can be extended.
Fiber mounting joint (Note)	MS-FX-03Y		The joint is used for mounting fibers on a tank.

Note: The joint internal ferrule (**MS-FX-YF**) is available as a spare part. A distorted ferrule may result in leakage.

Liquid inflow prevention joint

- **MS-FX-01Y**

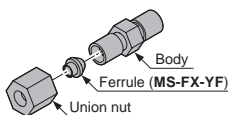

Protective tube extension joint

- **MS-FX-02Y**

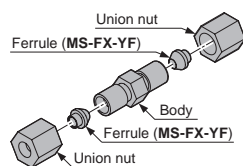

Fiber mounting joint

- **MS-FX-03Y**

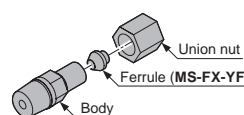

Applications

Detecting liquid level in a tank



Leak detection for use in semiconductor device manufacturing



Tough : Refers to a fiber which possesses both unbreakable (bending radius: R10 mm **R0.394 in**, reciprocating bending: 180°) and more flexible (bending radius: R4 mm **R0.157 in** or less) features.

New product introduction

Tough Fiber

Fiber Selection Guide

Model

Choose by shape/application

How to read Model No.

Earlier models comparison table

Fibers

Super Quality

Threaded Type

Square Head Type

Cylindrical Type

Sleeve

Flat Type

Small Spot

Narrow Beam

Wide Beam

Convergent Reflective Type

Retroreflective Type

Chemical / Oil-resistant

Heat-resistant

Vacuum-resistant

Liquid Leak / Liquid Detection

Fiber Options

Semi-custom fibers

Fiber Dimensions

Thru-beam Type

Retroreflective Type

Reflective Type

Others

Amplifiers

FX-500 series

FX-100 series

INDEX

SENSING RANGE

Fibers are listed in alphabetic order.
Refer to p. 2~ for details of each fiber.

Thru-beam type (one pair set)



Model No.	Sensing range (mm in) (Note 1)								Dimensions
	FX-500 series					FX-100 series			
	HYPR	U-LG	LONG	STD	FAST	H-SP	FX-101	FX-102	
FT-140	19,600 771.652 (Note 2)	19,600 771.652 (Note 2)	19,600 771.652 (Note 2)	19,600 771.652 (Note 2)	16,000 629.920	6,300 248.031	14,000 551.180	19,600 771.652 (Note 2)	P.48
FT-30	1,350 53.150	810 31.890	650 25.591	400 15.748	210 8.268	75 2.953	135 5.315	400 15.748	P.48
FT-31	1,350 53.150	770 30.315	550 21.654	315 12.402	210 8.268	70 2.756	130 5.118	340 13.386	P.48
FT-31S	1,220 48.031	740 29.134	550 21.654	315 12.402	195 7.677	63 2.480	130 5.118	340 13.386	P.48
FT-31W	990 38.976	590 23.228	440 17.323	260 10.236	150 5.906	53 2.087	80 3.150	240 9.449	P.48
FT-40	3,600 141.732 (Note 2)	2,200 86.614	1,700 66.929	1,200 47.244	530 20.866	190 7.480	320 12.598	870 34.252	P.48
FT-42	3,600 141.732 (Note 2)	2,050 80.709	1,600 62.992	1,130 44.488	530 20.866	190 7.480	300 11.811	800 31.496	P.48
FT-42S	3,600 141.732 (Note 2)	2,050 80.709	1,600 62.992	1,130 44.488	530 20.866	190 7.480	300 11.811	800 31.496	P.48
FT-42W	3,300 129.921	1,900 74.803	1,400 55.118	800 31.496	490 19.291	160 6.299	260 10.236	720 28.346	P.48
FT-43	3,600 141.732 (Note 2)	2,800 110.236	2,100 82.677	1,400 55.118	770 30.315	240 9.449	350 13.780	970 38.189	P.48
FT-45X	1,600 62.992 (Note 2)	1,600 62.992 (Note 2)	1,600 62.992 (Note 2)	1,200 47.244	630 24.803	200 7.874	340 13.386	920 36.220	P.49
FT-A11	3,600 141.732 (Note 2)	3,600 141.732 (Note 2)	3,600 141.732 (Note 2)	3,600 141.732 (Note 2)	3,600 141.732 (Note 2)	3,600 141.732 (Note 2)	1,100 43.307	3,600 141.732 (Note 2)	P.49
FT-A11W	3,600 141.732 (Note 2)	3,600 141.732 (Note 2)	3,600 141.732 (Note 2)	3,600 141.732 (Note 2)	3,600 141.732 (Note 2)	3,600 141.732 (Note 2)	1,300 51.181	3,400 133.858	P.49
FT-A32	3,600 141.732 (Note 2)	3,600 141.732 (Note 2)	3,600 141.732 (Note 2)	3,600 141.732 (Note 2)	3,600 141.732 (Note 2)	3,600 141.732 (Note 2)	2,100 82.677	3,600 141.732 (Note 2)	P.49
FT-A32W	3,600 141.732 (Note 2)	3,600 141.732 (Note 2)	3,600 141.732 (Note 2)	3,600 141.732 (Note 2)	3,600 141.732 (Note 2)	3,600 141.732 (Note 2)	3,000 118.110	3,600 141.732 (Note 2)	P.49
FT-AL05	2,300 90.551	1,550 61.024	1,500 59.055	860 33.858	500 19.685	170 6.693	250 9.843	660 25.984	P.49
FT-E13	52 2.047	30 1.181	24 0.945	15 0.591	8 0.315	2 0.079	6 0.236	19 0.748	P.49
FT-E23	270 10.630	160 6.299	125 4.921	75 2.953	42 1.654	13 0.512	22 0.866	80 3.150	P.49
FT-F93	Applicable pipe diameter: Outer dia. $\phi 3$ to $\phi 10$ mm $\phi 0.118$ to $\phi 0.394$ in transparent pipe [PFA (fluorine resin) or equivalently transparent pipe, wall thickness 0.3 to 1 mm 0.012 to 0.039 in] Liquid absent: Beam interrupted, Liquid present: Beam received Compatible amplifier: FX-500 series only								P.49
FT-H13-FM2	3,300 129.921	1,900 74.803	1,300 51.181	700 27.559	410 16.142	140 5.512	250 9.843	700 27.559	P.49
FT-H20-J20-S (Note 3)	1,600 62.992	1,000 39.370	790 31.102	470 18.504	300 11.811	90 3.543	135 5.315	420 16.535	P.50
FT-H20-J30-S (Note 3)	1,600 62.992	1,000 39.370	790 31.102	470 18.504	300 11.811	90 3.543	135 5.315	420 16.535	P.50
FT-H20-J50-S (Note 3)	1,600 62.992	1,000 39.370	790 31.102	470 18.504	300 11.811	90 3.543	135 5.315	420 16.535	P.50
FT-H20-M1	1,600 62.992 (Note 2)	1,300 51.181	960 37.795	540 21.260	330 12.992	110 4.331	210 8.268	540 21.260	P.50
FT-H20-VJ50-S (Note 3)	2,100 82.677	1,300 51.181	980 38.583	600 23.622	390 15.354	120 4.724	150 5.906	500 19.685	P.50
FT-H20-VJ80-S (Note 3)	2,100 82.677	1,300 51.181	980 38.583	600 23.622	390 15.354	120 4.724	150 5.906	500 19.685	P.50
FT-H20W-M1	1,600 62.992 (Note 2)	1,000 39.370	840 33.071	470 18.504	300 11.811	90 3.543	100 3.937	300 11.811	P.50
FT-H30-M1V-S (Note 4)	1,000 39.370	590 23.228	470 18.504	270 10.630	160 6.299	55 2.165	110 4.331	280 11.024	P.50
FT-H35-M2	1,200 47.244	880 34.646	670 26.378	430 16.929	250 9.843	80 3.150	170 6.693	490 19.291	P.50
FT-H35-M2S6	1,200 47.244	880 34.646	670 26.378	430 16.929	250 9.843	80 3.150	170 6.693	490 19.291	P.50
FT-HL80Y	3,600 141.732 (Note 2)	3,600 141.732 (Note 2)	3,600 141.732 (Note 2)	3,600 141.732 (Note 2)	2,300 90.551	740 29.134	990 38.976	2,340 92.126	P.50
FT-KS40	3,600 141.732 (Note 2)	3,600 141.732 (Note 2)	3,600 141.732 (Note 2)	3,600 141.732 (Note 2)	3,600 141.732 (Note 2)	3,600 141.732 (Note 2)	1,200 47.244	3,600 141.732 (Note 2)	P.51
FT-KV26	2,500 98.425	1,600 62.992	1,200 47.244	710 27.953	440 17.323	160 6.299	135 5.315	560 22.047	P.51
FT-KV40	3,600 141.732 (Note 2)	3,600 141.732 (Note 2)	3,600 141.732 (Note 2)	3,600 141.732 (Note 2)	3,600 141.732 (Note 2)	3,600 141.732 (Note 2)	1,200 47.244	3,600 141.732 (Note 2)	P.51
FT-KV40W	3,600 141.732 (Note 2)	3,600 141.732 (Note 2)	3,600 141.732 (Note 2)	3,600 141.732 (Note 2)	3,600 141.732 (Note 2)	3,100 122.047	940 37.008	3,600 141.732 (Note 2)	P.51
FT-L80Y	3,600 141.732 (Note 2)	3,600 141.732 (Note 2)	3,600 141.732 (Note 2)	3,600 141.732 (Note 2)	2,800 110.236	920 36.220	1,100 43.307	2,600 102.362	P.51
FT-R31	1,000 39.370	580 22.835	440 17.323	270 10.630	160 6.299	55 2.165	100 3.937	340 13.386	P.51
FT-R40	3,600 141.732 (Note 2)	1,750 68.898	1,500 59.055	930 36.614	500 19.685	160 6.299	270 10.630	740 29.134	P.51
FT-R41W	3,200 125.984	1,800 70.866	1,400 55.118	800 31.496	460 18.110	150 5.906	250 9.843	710 27.953	P.51
FT-R42W	3,600 141.732 (Note 2)	3,600 141.732 (Note 2)	3,500 137.795	2,200 86.614	1,300 51.181	460 18.110	510 20.079	2,000 78.740	P.51

Notes: 1) Note that the sensing range of the free-cut type fiber may be reduced by 20 % max. depending upon how the fiber is cut.
2) The fiber cable length practically limits the sensing range.
3) Heat-resistant joint fibers and ordinary-temperature fibers (FT-42) are sold as a set.
4) Sold as a set comprising vacuum type fiber + photo-terminal (FV-BR1) + fiber at atmospheric side (FT-J8).

SENSING RANGE

Fibers are listed in alphabetic order.
Refer to p. 2~ for details of each fiber.

Thru-beam type (one pair set)

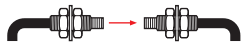

Model No.	Sensing range (mm in) (Note 1)								Dimensions
	FX-500 series						FX-100 series		
	HYPR	U-LG	LONG	STD	FAST	H-SP	FX-101	FX-102	
FT-R43	3,000 118.110	1,600 62.992	1,100 43.307	720 28.346	430 16.929	130 5.118	210 8.268	640 25.197	P.51
FT-R44Y	3,000 118.110	1,600 62.992	1,100 43.307	720 28.346	430 16.929	130 5.118	210 8.268	640 25.197	P.52
FT-R60Y	3,600 141.732 (Note 2)	3,600 141.732 (Note 2)	3,600 141.732 (Note 2)	2,100 82.677	1,260 49.606	400 15.748	690 27.165	1,890 74.409	P.52
FT-S11	350 13.780	210 8.268	160 6.299	90 3.543	60 2.362	19 0.748	40 1.575	90 3.543	P.52
FT-S20	1,350 53.150	810 31.890	650 25.591	400 15.748	210 8.268	75 2.953	135 5.315	400 15.748	P.52
FT-S21	1,350 53.150	770 30.315	550 21.654	315 12.402	210 8.268	70 2.756	130 5.118	340 13.386	P.52
FT-S21W	990 38.976	590 23.228	440 17.323	260 10.236	150 5.906	53 2.087	80 3.150	240 9.449	P.52
FT-S30	3,600 141.732 (Note 2)	2,200 86.614	1,700 66.929	1,200 47.244	530 20.866	190 7.480	320 12.598	870 34.252	P.52
FT-S31W	3,300 129.921	1,900 74.803	1,400 55.118	800 31.496	490 19.291	160 6.299	260 10.236	720 28.346	P.52
FT-S32	3,600 141.732 (Note 2)	3,600 141.732 (Note 2)	3,600 141.732 (Note 2)	3,100 122.047	1,800 70.866	600 23.622	1,100 43.307	3,000 118.110	P.52
FT-V23	1,800 70.866	1,000 39.370	880 34.646	450 17.717	280 11.024	90 3.543	160 6.299	400 15.748	P.52
FT-V24W	380 14.961	230 9.055	200 7.874	110 4.331	60 2.362	20 0.787	35 1.378	90 3.543	P.53
FT-V25	900 35.433	550 21.654	480 18.898	240 9.449	140 5.512	45 1.772	95 3.740	260 10.236	P.53
FT-V30	2,200 86.614	1,200 47.244	1,000 39.370	680 26.772	340 13.386	100 3.937	180 7.087	480 18.898	P.53
FT-V40	3,600 141.732 (Note 2)	3,600 141.732 (Note 2)	3,600 141.732 (Note 2)	3,500 137.795	2,400 94.488	850 33.465	1,000 39.370	3,100 122.047	P.53
FT-V80Y	3,600 141.732 (Note 2)	2,800 110.236	2,200 86.614	1,300 51.181	800 31.496	240 9.449	340 13.386	800 31.496	P.53
FT-Z20HBW	1,100 43.307	670 26.378	570 22.441	260 10.236	180 7.087	55 2.165	100 3.937	320 12.598	P.53
FT-Z20W	1,600 62.992 (Note 2)	1,500 59.055	1,100 43.307	620 24.409	420 16.535	130 5.118	280 11.024	730 28.740	P.53
FT-Z30	3,600 141.732 (Note 2)	3,600 141.732 (Note 2)	3,600 141.732 (Note 2)	2,100 82.677	1,200 47.244	410 16.142	710 27.953	2,300 90.551	P.53
FT-Z30E	3,600 141.732 (Note 2)	3,600 141.732 (Note 2)	3,600 141.732 (Note 2)	3,500 137.795	2,400 94.488	740 29.134	1,200 47.244	3,200 125.984	P.53
FT-Z30EW	3,600 141.732 (Note 2)	3,600 141.732 (Note 2)	3,600 141.732 (Note 2)	3,400 133.858	2,000 78.740	630 24.803	1,400 55.118	2,600 102.362	P.54
FT-Z30H	3,600 141.732 (Note 2)	3,600 141.732 (Note 2)	3,600 141.732 (Note 2)	3,500 137.795	2,600 102.362	810 31.890	1,400 55.118	3,200 125.984	P.54
FT-Z30HW	3,600 141.732 (Note 2)	3,600 141.732 (Note 2)	3,600 141.732 (Note 2)	3,500 137.795	2,600 102.362	810 31.890	1,400 55.118	3,200 125.984	P.54
FT-Z30W	3,600 141.732 (Note 2)	3,300 129.921	3,200 125.984	1,500 59.055	1,000 39.370	280 11.024	540 21.260	1,800 70.866	P.54
FT-Z40HBW	3,300 129.921	1,900 74.803	1,400 55.118	800 31.496	490 19.291	160 6.299	260 10.236	720 28.346	P.54
FT-Z40W	3,600 141.732 (Note 2)	3,300 129.921	2,300 90.551	1,500 59.055	900 35.433	290 11.417	410 16.142	1,200 47.244	P.54
FT-Z802Y	3,600 141.732 (Note 2)	3,600 141.732 (Note 2)	3,600 141.732 (Note 2)	3,100 122.047	1,900 74.803	470 18.504	520 20.472	3,100 122.047	P.54

Notes: 1) Note that the sensing range of the free-cut type fiber may be reduced by 20 % max. depending upon how the fiber is cut.
2) The fiber cable length practically limits the sensing range.

New product introduction
Tough Fiber

Fiber Selection Guide
Model
Choose by shape/application
How to read Model No.
Earlier models comparison table

Fibers
Super Quality
Threaded Type
Square Head Type
Cylindrical Type
Sleeve
Flat Type
Small Spot
Narrow Beam
Wide Beam
Convergent Reflective Type
Retroreflective Type
Chemical / Oil-resistant
Heat-resistant
Vacuum-resistant
Liquid Leak / Liquid Detection

Fiber Options
Semi-custom fibers

Fiber Dimensions
Thru-beam Type
Retroreflective Type
Reflective Type
Others

Amplifiers
FX-500 series
FX-100 series

INDEX

SENSING RANGE

Fibers are listed in alphabetic order.
Refer to p. 2~ for details of each fiber.

Retroreflective type



Model No.	Sensing range (mm in) (Note 1, 2)								Dimensions
	FX-500 series						FX-100 series		
	HYPR	U-LG	LONG	STD	FAST	H-SP	FX-101	FX-102	
FR-KZ22E	15 to 570 0.591 to 22.441	15 to 460 0.591 to 18.110	15 to 410 0.591 to 16.142	15 to 310 0.591 to 12.205	15 to 220 0.591 to 8.661	15 to 100 0.591 to 3.937	15 to 200 0.591 to 7.874	15 to 360 0.591 to 14.173	P.55
FR-KZ50E	20 to 1,000 0.787 to 39.370	20 to 800 0.787 to 31.496	20 to 400 0.787 to 15.748	20 to 300 0.787 to 11.811	20 to 200 0.787 to 7.874	20 to 200 0.787 to 7.874	20 to 200 0.787 to 7.874	20 to 350 0.787 to 13.780	P.55
FR-KZ50H	20 to 1,000 0.787 to 39.370	20 to 800 0.787 to 31.496	20 to 400 0.787 to 15.748	20 to 300 0.787 to 11.811	20 to 200 0.787 to 7.874	20 to 200 0.787 to 7.874	20 to 200 0.787 to 7.874	20 to 350 0.787 to 13.780	P.55
FR-Z50HW	100 to 1,900 3.937 to 74.803	100 to 1,400 3.937 to 55.118	100 to 1,200 3.937 to 47.244	100 to 990 3.937 to 38.976	100 to 780 3.937 to 30.709	100 to 490 3.937 to 19.291	100 to 550 3.937 to 21.654	100 to 830 3.937 to 32.677	P.55

- Notes: 1) Note that the sensing range of the free-cut type fiber may be reduced by 20 % max. depending upon how the fiber is cut.
The sensing range of **FR-Z50HW** is specified for the **RF-13**. The sensing range of **FR-KZ50H** and **FR-KZ50E** is specified for the attached reflector **RF-003**. The sensing range of **FR-KZ22E** is specified for the attached reflector.
- 2) The sensing range of retroreflective type is the possible setting range for the attached reflector. The fiber can detect an object less than setting range for the reflector. However, note that if there are any white or highly-reflective surfaces near the fiber head, reflected incident light may affect the fiber head. If this occurs, adjust the threshold value of the amplifier unit before use.

Sensing range when FR-Z50HW is used in combination with a reflector (optional)

Reflector Model No.	Sensing range (mm in)							
	FX-500 series						FX-100 series	
	HYPR	U-LG	LONG	STD	FAST	H-SP	FX-101	FX-102
RF-230	100 to 19,000 3.937 to 748.03	100 to 8,000 3.937 to 314.960	100 to 5,000 3.937 to 196.850	100 to 3,600 3.937 to 141.732	100 to 2,900 3.937 to 114.173	100 to 1,400 3.937 to 55.118	100 to 2,400 3.937 to 94.488	100 to 5,000 3.937 to 196.850
RF-220	100 to 8,000 3.937 to 314.960	100 to 4,700 3.937 to 185.039	100 to 3,500 3.937 to 137.795	100 to 3,000 3.937 to 118.110	100 to 1,800 3.937 to 70.866	100 to 830 3.937 to 32.677	100 to 1,300 3.937 to 51.181	100 to 2,600 3.937 to 102.362
RF-210	100 to 5,500 3.937 to 216.535	100 to 2,700 3.937 to 106.299	100 to 2,400 3.937 to 94.488	100 to 1,500 3.937 to 59.055	100 to 1,200 3.937 to 47.244	100 to 530 3.937 to 20.866	100 to 980 3.937 to 38.583	100 to 1,300 3.937 to 51.181

- Note: 1) The sensing range of retroreflective type is the possible setting range for the attached reflector. The fiber can detect an object less than 100 mm 3.937 in. However, note that if there are any white or highly-reflective surfaces near the fiber head, reflected incident light may affect the fiber head. If this occurs, adjust the threshold value of the amplifier unit before use.

New product introduction
Tough Fiber

Fiber Selection Guide

Model

Choose by shape/application

How to read Model No

Earlier models comparison table

Fibers

Super Quality

Threaded Type

Square Head Type

Cylindrical Type

Sleeve

Flat Type

Small Spot

Narrow Beam

Wide Beam

Convergent Reflective Type

Retroreflective Type

Chemical / Oil-resistant

Heat-resistant

Vacuum-resistant

Liquid Leak / Liquid Detection

Fiber Options

Semi-custom fibers

Fiber Dimensions

Thru-beam Type

Retroreflective Type

Reflective Type

Others

Amplifiers

FX-500 series

FX-100 series

INDEX

SENSING RANGE

Fibers are listed in alphabetic order.
Refer to p. 2~ for details of each fiber.

Reflective type



Model No.	Sensing range (mm in) (Note 1, 2)								Dimensions
	FX-500 series						FX-100 series		
	HYP	U-LG	LONG	STD	FAST	H-SP	FX-101	FX-102	
FD-30	600	330	250	160	80	25	45	155	P.56
	23.622	12.992	9.843	6.299	3.150	0.984	1.772	6.102	
FD-31	515	290	220	125	80	25	35	140	P.56
	20.276	11.417	8.661	4.921	3.150	0.984	1.378	5.512	
FD-31W	330	180	140	80	45	12	15	60	P.56
FD-32G	650	380	270	200	95	27	70	190	P.56
	25.591	14.961	10.630	7.874	3.740	1.063	2.756	7.480	
FD-32GX	630	410	360	200	100	30	75	210	P.56
FD-40	600	330	250	160	80	25	45	155	P.56
	23.622	12.992	9.843	6.299	3.150	0.984	1.772	6.102	
FD-41	515	290	220	125	80	25	35	140	P.56
	20.276	11.417	8.661	4.921	3.150	0.984	1.378	5.512	
FD-41S	515	290	220	125	80	25	35	140	P.56
FD-41SW	330	180	140	80	45	12	15	60	P.56
	12.992	7.087	5.512	3.150	1.772	0.472	0.591	2.362	
FD-41W	900	630	430	270	150	45	80	230	P.56
FD-42G	650	380	270	200	95	27	70	190	P.57
	25.591	14.961	10.630	7.874	3.740	1.063	2.756	7.480	
FD-42GW	670	340	280	150	90	25	45	140	P.57
FD-60	1,550	900	740	520	260	90	140	420	P.57
	61.024	35.433	29.134	20.472	10.236	3.543	5.512	16.535	
FD-61	1,400	840	670	450	200	70	120	410	P.57
	55.118	33.071	26.378	17.717	7.874	2.756	4.724	16.142	
FD-61G	1,100	800	650	420	200	60	120	350	P.57
	43.307	31.496	25.591	16.535	7.874	2.362	4.724	13.780	
FD-61S	1,200	790	660	420	220	75	130	360	P.57
	47.244	31.102	25.984	16.535	8.661	2.953	5.118	14.173	
FD-61W	900	630	430	270	150	45	80	230	P.57
	35.433	24.803	16.929	10.630	5.906	1.772	3.150	9.055	
FD-62	1,500	1,000	940	520	340	110	170	450	P.57
	59.055	39.370	37.008	20.472	13.386	4.331	6.693	17.717	
FD-64X	670	500	410	280	160	50	75	220	P.58
	26.378	19.685	16.142	11.024	6.299	1.969	2.953	8.661	
FD-A16	—	200	200	200	140	75	120	240	P.58
	—	7.874	7.874	7.874	5.512	2.953	4.724	9.449	
FD-AL11	670	530	510	320	180	50	100	285	P.58
	26.378	20.866	20.079	12.598	7.087	1.969	3.937	11.220	
FD-E13	50	29	25	12	7	2	5	15	P.58
	1.969	1.142	0.984	0.472	0.276	0.079	0.197	0.591	
FD-E23	170	120	80	55	30	9	20	70	P.58
	6.693	4.724	3.150	2.165	1.181	0.354	0.787	2.756	
FD-EG30	170	130	110	48	30	9	20	70	P.58
	6.693	5.118	4.331	1.890	1.181	0.354	0.787	2.756	
FD-EG30S	170	110	80	50	30	9	20	70	P.59
	6.693	4.331	3.150	1.969	1.181	0.354	0.787	2.756	
FD-EG31	85	45	35	20	12	3.5	7	25	P.59
	3.346	1.772	1.378	0.787	0.472	0.138	0.276	0.984	
FD-F4	Applicable pipe diameter: Outer dia. $\phi 6$ to $\phi 26$ mm $\phi 0.236$ to $\phi 1.024$ in transparent pipe [PFA (fluorine resin) or equivalently transparent pipe, wall thickness 1 mm 0.039 in] Liquid absent: Beam received, Liquid present: Beam interrupted								P.59
FD-F41	Applicable pipe diameter: Outer dia. $\phi 6$ to $\phi 26$ mm $\phi 0.236$ to $\phi 1.024$ in transparent pipe [PVC (vinyl chloride), fluorine resin, polycarbonate, acrylic, glass, wall thickness 1 to 3 mm 0.039 to 0.118 in] Liquid absent: Beam received, Liquid present: Beam interrupted								P.59
FD-F41Y (Note 3)	$\phi 4$ mm $\phi 0.157$ in Protective tube: Fluorine resin, length 500 mm 19.685 in (cuttable) Liquid surface not contacted: Beam received, Liquid surface contacted: Beam interrupted								P.59
FD-F71	Liquid leak detection Leak absent: Beam received, Leak present: Beam interrupted Compatible amplifier: FX-500 series only								P.59
FD-F8Y	$\phi 6$ mm $\phi 0.236$ in Protective tube: Fluorine resin, length 1,000 mm 39.370 in (not cuttable) Liquid surface not contacted: Beam received, Liquid surface contacted: Beam interrupted								P.59
FD-FA93	Applicable pipe diameter: Outer dia. $\phi 8$ mm $\phi 0.315$ in or more transparent pipe (When used with the tying bands: $\phi 8$ to $\phi 80$ mm $\phi 0.315$ to $\phi 3.150$ in) [PFA (fluorine resin), including translucent] Liquid absent: Beam received, Liquid present: Beam interrupted								P.59

Notes: 1) Note that the sensing range of the free-cut type fiber may be reduced by 20 % max. depending upon how the fiber is cut.
2) The sensing range is specified for white non-glossy paper.
3) Liquid inflow prevention joint, protective tube extension joint, fiber mounting joint are available. Please refer to page 35 for details.

New product
introduction
Tough
Fiber

Fiber
Selection
Guide

Model
Choose
by shape/
application
How to read
Model No.
Earlier models
comparison
table

Fibers

Super
Quality

Threaded
Type

Square Head
Type

Cylindrical
Type

Sleeve

Flat
Type

Small
Spot

Narrow
Beam

Wide
Beam

Convergent
Reflective
Type

Retroreflective
Type

Chemical / Oil-
resistant

Heat-
resistant

Vacuum-
resistant

Liquid Leak /
Liquid Detection

Fiber
Options

Semi-custom
fibers

Fiber
Dimensions

Thru-beam
Type

Retroreflective
Type

Reflective
Type

Others

Amplifiers

FX-500
series

FX-100
series

INDEX

SENSING RANGE

Fibers are listed in alphabetic order. Refer to p. 2~ for details of each fiber.

Reflective type



Model No.	Sensing range (mm in) (Note 1, 2)								Dimensions
	FX-500 series					FX-100 series			
	HYPR	U-LG	LONG	STD	FAST	H-SP	FX-101	FX-102	
FD-H13-FM2	880 34.646	640 25.197	600 23.622	350 13.780	200 7.874	65 2.559	100 3.937	280 11.024	P.60
FD-H18-L31	60 2.362	32 1.260	24 0.945	16 0.630	13 0.512	2 to 6.5 0.079 to 0.256	0 to 10 0 to 0.394	0 to 25 0 to 0.984	P.60
FD-H20-21	770 30.315	500 19.685	380 14.961	230 9.055	130 5.118	45 1.772	90 3.543	280 11.024	P.60
FD-H20-M1	840 33.071	550 21.654	500 19.685	330 12.992	200 7.874	55 2.165	120 4.724	300 11.811	P.60
FD-H25-L43 (Note 3)	1 to 31 0.039 to 1.220	1 to 30 0.039 to 1.181	1 to 28 0.039 to 1.102	1.5 to 26 0.059 to 1.024	1.5 to 24 0.059 to 0.945	2 to 18 0.079 to 0.709	4 to 16 0.157 to 0.630	4 to 23 0.157 to 0.906	P.60
FD-H25-L45 (Note 3)	4 to 43.5 0.157 to 1.713	4 to 43 0.157 to 1.693	4.5 to 43 0.177 to 1.693	5 to 42 0.197 to 1.654	5 to 40 0.197 to 1.575	6.5 to 34 0.256 to 1.339	7 to 35 0.276 to 1.378	7 to 38 0.276 to 1.496	P.60
FD-H30-KZ1V-S (Note 3, 4)	5 to 500 0.197 to 19.685	10 to 340 0.394 to 13.386	15 to 270 0.591 to 10.630	20 to 200 0.787 to 7.874	20 to 120 0.787 to 4.724	20 to 45 0.787 to 1.772	25 to 80 0.984 to 3.150	10 to 220 0.394 to 8.661	P.61
FD-H30-L32	40 1.575	30 1.181	25 0.984	17 0.669	12 0.472	1.5 to 6 0.059 to 0.236	2 to 9 0.079 to 0.354	0 to 17 0 to 0.669	P.61
FD-H30-L32V-S (Note 3, 4)	18 0.709	12 0.472	10 0.394	8 0.315	5.5 0.217	1.5 to 3 0.059 to 0.118	2.5 to 6.5 0.098 to 0.256	0 to 11 0 to 0.433	P.61
FD-H35-20S	840 33.071	550 21.654	440 17.323	260 10.236	140 5.512	45 1.772	85 3.346	200 7.874	P.61
FD-H35-M2	720 28.346	540 21.260	460 18.110	236 10.236	150 5.906	45 1.772	75 2.953	280 11.024	P.61
FD-H35-M2S6	720 28.346	540 21.260	460 18.110	260 10.236	150 5.906	45 1.772	75 2.953	280 11.024	P.61
FD-HF40Y (Note 5)	ø4 mm ø0.157 in Protective tube: Fluorine resin, length 500 mm 19.685 in (cuttable) Liquid surface not contacted: Beam received, Liquid surface contacted: Beam not received								P.61
FD-L10 (Note 3)	0 to 6 0 to 0.236	0 to 5.5 0 to 0.217	0 to 5.5 0 to 0.217	0 to 5 0 to 0.197	0 to 4.5 0 to 0.177	0 to 4 0 to 0.157	0 to 4.5 0 to 0.177	0 to 5.5 0 to 0.217	P.62
FD-L11 (Note 3)	0 to 11.5 0 to 0.453	0 to 10.5 0 to 0.413	0 to 10 0 to 0.394	0 to 9.5 0 to 0.374	0 to 9 0 to 0.354	0 to 8 0 to 0.315	0 to 8 0 to 0.315	0 to 9 0 to 0.354	P.62
FD-L12W (Note 3)	14 0.551	12.5 0.492	12 0.472	8 0.315	0.5 to 7 0.020 to 0.276	0.5 to 4 0.020 to 0.157	1 to 4.5 0.039 to 0.177	0.5 to 7 0.020 to 0.276	P.62
FD-L20H	45 1.772	35 1.378	32 1.260	23 0.906	2 to 15 0.079 to 0.591	5 to 9 0.197 to 0.354	5 to 15 0.197 to 0.591	1 to 30 0.039 to 1.181	P.62
FD-L21 (Note 3)	1 to 19 0.039 to 0.748	1 to 18 0.039 to 0.709	1 to 18 0.039 to 0.709	1.5 to 16 0.059 to 0.630	2 to 15 0.079 to 0.591	3 to 12 0.118 to 0.472	3 to 15 0.118 to 0.591	1.5 to 16 0.059 to 0.630	P.62
FD-L21W (Note 3)	1.5 to 15 0.059 to 0.591	2 to 15 0.079 to 0.591	2 to 15 0.079 to 0.591	3 to 14 0.118 to 0.551	4 to 14 0.158 to 0.551	6.5 to 10 0.256 to 0.394	7 to 12 0.276 to 0.472	3 to 14 0.118 to 0.551	P.62
FD-L22A (Note 3)	0 to 31 0 to 1.220	0 to 28 0 to 1.102	0 to 27 0 to 1.063	0 to 24 0 to 0.945	0 to 24 0 to 0.945	0 to 18 0 to 0.709	0 to 19 0 to 0.748	0 to 25 0 to 0.984	P.62
FD-L23 (Note 3)	0 to 30 0 to 1.181	0 to 30 0 to 1.181	0 to 30 0 to 1.181	0 to 29 0 to 1.142	0 to 28 0 to 1.102	1.5 to 24 0.059 to 0.945	0 to 28 0 to 1.102	0 to 30 0 to 1.181	P.62
FD-L30A (Note 3)	0 to 43 0 to 1.693	0 to 43 0 to 1.693	0 to 43 0 to 1.693	0 to 43 0 to 1.693	0 to 42 0 to 1.654	0 to 29 0 to 1.142	0 to 40 0 to 1.575	0 to 50 0 to 1.969	P.62
FD-L31A (Note 3)	3 to 35 0.118 to 1.378	4 to 33 0.157 to 1.299	4 to 33 0.157 to 1.299	4 to 33 0.157 to 1.299	4 to 32 0.157 to 1.260	5 to 25 0.197 to 0.984	5 to 30 0.197 to 1.181	4 to 33 0.157 to 1.299	P.62
FD-L32H (Note 3)	0 to 110 0 to 4.331	0 to 87 0 to 3.425	0 to 74 0 to 2.913	0 to 56 0 to 2.205	1 to 38 0.039 to 1.496	—	16 to 30 0.630 to 1.181	0 to 50 0 to 1.969	P.63
FD-R31G	530 20.866	310 12.205	260 10.236	170 6.693	85 3.346	27 1.063	45 1.772	150 5.906	P.63
FD-R32EG	170 6.693	110 4.331	92 3.622	45 1.772	30 1.181	9 0.354	20 0.787	68 2.677	P.63
FD-R33EG	84 3.307	44 1.732	33 1.299	19 0.748	11 0.433	3 0.118	7 0.276	22 0.866	P.63
FD-R34EG	130 5.118	90 3.543	70 2.756	38 1.496	23 0.906	7 0.276	17 0.669	60 2.362	P.63
FD-R41	710 27.953	430 16.929	320 12.598	210 8.268	100 3.937	34 1.339	60 2.362	170 6.693	P.63
FD-R60	1,100 43.307	600 23.622	550 21.654	290 11.417	190 7.480	65 2.559	110 4.331	240 9.449	P.63
FD-R61Y	990 38.976	610 24.016	435 17.126	280 11.024	160 6.299	50 1.969	85 3.346	185 7.283	P.63
FD-S21	190 7.480	130 5.118	110 4.331	80 3.150	37 1.457	11 0.433	25 0.984	70 2.756	P.63
FD-S30	600 23.622	330 12.992	250 9.843	160 6.299	80 3.15	25 0.984	45 1.772	155 6.102	P.64
FD-S31	515 20.276	290 11.417	220 8.661	125 4.921	80 3.15	25 0.984	35 1.378	140 5.512	P.64
FD-S32	1,200 47.244	790 31.102	660 25.984	420 16.535	220 8.661	75 2.953	120 4.724	345 13.583	P.64

- Notes: 1) Note that the sensing range of the free-cut type fiber may be reduced by 20 % max. depending upon how the fiber is cut.
- 2) The sensing range of reflective type is the value for white non-glossy paper (as for FD-H30-L32 and FD-H18-L31 50 x 50 mm 1.969 x 1.969 in glass substrate).
- 3) The sensing range is specified for transparent glass 100 x 100 x 10.7 mm 3.937 x 3.937 x t0.028 in (FD-L32H: R edge, FD-L21 and FD-L21W: t2 mm t0.079 in) [FD-L10: silicon wafers 100 x 100 mm 3.937 x 3.937 in].
- 4) Sold as a set comprising vacuum type fiber + photo-terminal (FV-BR1) + fiber at atmospheric side (FT-J8).
- 5) Liquid inflow prevention joint, protective tube extension joint, fiber mounting joint are available. Please refer to page 35 for details.

Fiber Selection Guide
Model
Choose by shape/application
How to read Model No.
Earlier models comparison table
Fibers
Super Quality
Threaded Type
Square Head Type
Cylindrical Type
Sleeve
Flat Type
Small Spot
Narrow Beam
Wide Beam
Convergent Reflective Type
Retroreflective Type
Chemical / Oil-resistant
Heat-resistant
Vacuum-resistant
Liquid Leak / Liquid Detection
Fiber Options
Semi-custom fibers
Fiber Dimensions
Thru-beam Type
Retroreflective Type
Reflective Type
Others
Amplifiers
FX-500 series
FX-100 series
INDEX

SENSING RANGE

Fibers are listed in alphabetic order.
Refer to p. 2~ for details of each fiber.

Reflective type

Model No.	Sensing range (mm in) (Note 1, 2)								Dimensions
	FX-500 series						FX-100 series		
	HYP	U-LG	LONG	STD	FAST	H-SP	FX-101	FX-102	
FD-S32W	900 35.433	630 24.803	430 16.929	270 10.630	150 5.906	45 1.772	80 3.150	230 9.055	P.64
FD-S33GW	670 26.378	340 13.386	280 11.024	150 5.906	90 3.543	25 0.984	45 1.772	140 5.512	P.64
FD-S60Y	600 23.622	590 23.228	420 16.535	320 12.598	200 7.874	75 2.953	140 5.512	300 11.811	P.64
FD-V30	240 9.449	130 5.118	120 4.724	65 2.559	35 1.378	14 0.551	25 0.984	75 2.953	P.64
FD-V30W	80 3.150	40 1.575	30 1.181	20 0.787	10 0.394	2 0.079	6 0.236	20 0.787	P.64
FD-V50	370 14.567	220 8.661	210 8.268	120 4.724	75 2.953	25 0.984	40 1.575	100 3.937	P.65
FD-Z20HBW	1 to 340 0.039 to 13.386	1 to 210 0.039 to 8.268	1 to 180 0.039 to 7.087	2 to 85 0.079 to 3.346	2 to 55 0.079 to 2.165	3 to 15 0.118 to 0.591	2 to 30 0.079 to 1.181	1 to 90 0.039 to 3.543	P.65
FD-Z20W	260 10.236	150 5.906	130 5.118	1 to 65 0.039 to 2.559	2 to 45 0.079 to 1.772	5 to 13 0.197 to 0.512	2 to 32 0.079 to 1.260	1 to 80 0.039 to 3.150	P.65
FD-Z40HBW	760 29.921	540 21.260	470 18.504	260 10.236	1 to 160 0.039 to 6.299	2 to 50 0.079 to 1.969	1 to 90 0.039 to 3.543	0.5 to 240 0.020 to 9.449	P.65
FD-Z40W	790 31.102	440 17.323	390 15.354	190 7.480	1 to 120 0.039 to 4.724	2 to 35 0.079 to 1.378	1 to 74 0.039 to 2.913	200 7.874	P.65
FD-Z50HW (Note 3)	10 to 2,500 0.394 to 98.425	10 to 1,100 0.394 to 43.307	10 to 1,000 0.394 to 39.370	10 to 650 0.394 to 25.591	10 to 410 0.394 to 16.142	15 to 130 0.591 to 5.118	10 to 200 0.394 to 7.874	10 to 530 0.394 to 20.866	P.65

- Notes: 1) Note that the sensing range of the free-cut type fiber may be reduced by 20 % max. depending upon how the fiber is cut.
 2) The sensing range is specified for white non-glossy paper (except for **FD-Z50HW**).
 3) The sensing range is the possible setting range for the attached reflector. The fiber can detect an object less than setting range for the reflector.
 Refer to P.38 for the sensing range when **FR-Z50HW** is used in combination with a reflector (optional).

- New product introduction
- Tough Fiber
- Fiber Selection Guide
- Model
- Choose by shape/application
- How to read Model No.
- Earlier models comparison table
- Fibers
- Super Quality
- Threaded Type
- Square Head Type
- Cylindrical Type
- Sleeve
- Flat Type
- Small Spot
- Narrow Beam
- Wide Beam
- Convergent Reflective Type
- Retroreflective Type
- Chemical / Oil-resistant
- Heat-resistant
- Vacuum-resistant
- Liquid Leak / Liquid Detection
- Fiber Options
- Semi-custom fibers
- Fiber Dimensions
- Thru-beam Type
- Retroreflective Type
- Reflective Type
- Others
- Amplifiers
- FX-500 series
- FX-100 series
- INDEX

FIBER OPTIONS

Refer to p.66~ for details of lens dimensions.

Lens (For thru-beam type fiber)

Designation	Model No.	Description																																																																																																																																																																
Expansion lens (Note 1)	FX-LE1	Increases the sensing range by 5 times or more. • Ambient temperature: -60 to +350 °C -76 to +662 °F (Note 4) • Beam dia: ø3.6 mm ø0.142 in Sensing range (mm in) [Lens on both sides]																																																																																																																																																																
		<table border="1"> <thead> <tr> <th colspan="2">Amplifier</th> <th colspan="6">FX-500 series</th> <th colspan="2">FX-100 series</th> </tr> <tr> <th>Fiber</th> <th>Mode</th> <th>HYPR</th> <th>U-LG</th> <th>LONG</th> <th>STD</th> <th>FAST</th> <th>H-SP</th> <th>FX-101</th> <th>FX-102</th> </tr> </thead> <tbody> <tr> <td>FT-43</td> <td></td> <td>3,600 141.732 (Note 2)</td> <td>3,600 141.732 (Note 2)</td> <td>3,600 141.732 (Note 2)</td> <td>3,600 141.732 (Note 2)</td> <td>3,600 141.732 (Note 2)</td> <td>3,600 141.732 (Note 2)</td> <td>1,600 62.992</td> <td>2,400 94.488</td> <td>3,600 141.732 (Note 2)</td> </tr> <tr> <td>FT-42</td> <td></td> <td>3,600 141.732 (Note 2)</td> <td>3,600 141.732 (Note 2)</td> <td>3,600 141.732 (Note 2)</td> <td>3,600 141.732 (Note 2)</td> <td>3,600 141.732 (Note 2)</td> <td>3,600 141.732 (Note 2)</td> <td>2,200 86.614</td> <td>3,400 133.858</td> <td>3,600 141.732 (Note 2)</td> </tr> <tr> <td>FT-42W</td> <td></td> <td>3,600 141.732 (Note 2)</td> <td>3,600 141.732 (Note 2)</td> <td>3,600 141.732 (Note 2)</td> <td>3,600 141.732 (Note 2)</td> <td>3,600 141.732 (Note 2)</td> <td>3,600 141.732 (Note 2)</td> <td>2,200 86.614</td> <td>3,400 133.858</td> <td>3,600 141.732 (Note 2)</td> </tr> <tr> <td>FT-45X</td> <td></td> <td>1,600 62.992 (Note 2)</td> <td>1,600 62.992 (Note 2)</td> <td>1,600 62.992 (Note 2)</td> <td>1,600 62.992 (Note 2)</td> <td>1,600 62.992 (Note 2)</td> <td>1,600 62.992 (Note 2)</td> <td>1,500 59.055</td> <td>1,600 62.992 (Note 2)</td> <td>1,600 62.992 (Note 2)</td> </tr> <tr> <td>FT-R40</td> <td></td> <td>3,600 141.732 (Note 2)</td> <td>3,600 141.732 (Note 2)</td> <td>3,600 141.732 (Note 2)</td> <td>3,600 141.732 (Note 2)</td> <td>3,600 141.732 (Note 2)</td> <td>3,600 141.732 (Note 2)</td> <td>3,100 122.047</td> <td>3,100 122.047</td> <td>3,600 141.732 (Note 2)</td> </tr> <tr> <td>FT-R42W</td> <td></td> <td>3,600 141.732 (Note 2)</td> <td>3,600 141.732 (Note 2)</td> <td>3,600 141.732 (Note 2)</td> <td>3,600 141.732 (Note 2)</td> <td>3,600 141.732 (Note 2)</td> <td>3,600 141.732 (Note 2)</td> <td>2,200 86.614</td> <td>3,400 133.858</td> <td>3,600 141.732 (Note 2)</td> </tr> <tr> <td>FT-R43</td> <td></td> <td>3,600 141.732 (Note 2)</td> <td>3,600 141.732 (Note 2)</td> <td>3,600 141.732 (Note 2)</td> <td>3,600 141.732 (Note 2)</td> <td>3,600 141.732 (Note 2)</td> <td>3,600 141.732 (Note 2)</td> <td>2,670 105.181</td> <td>2,670 105.181</td> <td>3,600 141.732 (Note 2)</td> </tr> <tr> <td>FT-H35-M2</td> <td></td> <td>3,600 141.732 (Note 2)</td> <td>3,600 141.732 (Note 2)</td> <td>3,600 141.732 (Note 2)</td> <td>3,600 141.732 (Note 2)</td> <td>3,600 141.732 (Note 2)</td> <td>3,600 141.732 (Note 2)</td> <td>3,300 129.921</td> <td>1,400 55.118</td> <td>3,500 137.795</td> </tr> <tr> <td>FT-H20W-M1</td> <td></td> <td>1,600 62.992 (Note 2)</td> <td>1,600 62.992 (Note 2)</td> <td>1,600 62.992 (Note 2)</td> <td>1,600 62.992 (Note 2)</td> <td>1,600 62.992 (Note 2)</td> <td>1,600 62.992 (Note 2)</td> <td>850 33.465</td> <td>1,300 51.181</td> <td>1,600 62.992 (Note 2)</td> </tr> <tr> <td>FT-H20-M1</td> <td></td> <td>1,600 62.992 (Note 2)</td> <td>1,600 62.992 (Note 2)</td> <td>1,600 62.992 (Note 2)</td> <td>1,600 62.992 (Note 2)</td> <td>1,600 62.992 (Note 2)</td> <td>1,600 62.992 (Note 2)</td> <td>1,200 47.244</td> <td>1,600 62.992 (Note 2)</td> <td>1,600 62.992 (Note 2)</td> </tr> <tr> <td>FT-H20-J50-S</td> <td></td> <td>3,600 141.732 (Note 2)</td> <td>3,600 141.732 (Note 2)</td> <td>3,500 137.795</td> <td>2,000 78.740</td> <td>1,600 62.992</td> <td>500 19.685</td> <td>1,000 39.370</td> <td>3,500 137.795 (Note 2)</td> </tr> <tr> <td>FT-H20-J30-S</td> <td></td> <td></td> <td></td> <td></td> <td></td> <td></td> <td></td> <td></td> <td></td> </tr> <tr> <td>FT-H20-J20-S</td> <td></td> <td></td> <td></td> <td></td> <td></td> <td></td> <td></td> <td></td> <td></td> </tr> </tbody> </table>	Amplifier		FX-500 series						FX-100 series		Fiber	Mode	HYPR	U-LG	LONG	STD	FAST	H-SP	FX-101	FX-102	FT-43		3,600 141.732 (Note 2)	3,600 141.732 (Note 2)	3,600 141.732 (Note 2)	3,600 141.732 (Note 2)	3,600 141.732 (Note 2)	3,600 141.732 (Note 2)	1,600 62.992	2,400 94.488	3,600 141.732 (Note 2)	FT-42		3,600 141.732 (Note 2)	3,600 141.732 (Note 2)	3,600 141.732 (Note 2)	3,600 141.732 (Note 2)	3,600 141.732 (Note 2)	3,600 141.732 (Note 2)	2,200 86.614	3,400 133.858	3,600 141.732 (Note 2)	FT-42W		3,600 141.732 (Note 2)	3,600 141.732 (Note 2)	3,600 141.732 (Note 2)	3,600 141.732 (Note 2)	3,600 141.732 (Note 2)	3,600 141.732 (Note 2)	2,200 86.614	3,400 133.858	3,600 141.732 (Note 2)	FT-45X		1,600 62.992 (Note 2)	1,600 62.992 (Note 2)	1,600 62.992 (Note 2)	1,600 62.992 (Note 2)	1,600 62.992 (Note 2)	1,600 62.992 (Note 2)	1,500 59.055	1,600 62.992 (Note 2)	1,600 62.992 (Note 2)	FT-R40		3,600 141.732 (Note 2)	3,600 141.732 (Note 2)	3,600 141.732 (Note 2)	3,600 141.732 (Note 2)	3,600 141.732 (Note 2)	3,600 141.732 (Note 2)	3,100 122.047	3,100 122.047	3,600 141.732 (Note 2)	FT-R42W		3,600 141.732 (Note 2)	3,600 141.732 (Note 2)	3,600 141.732 (Note 2)	3,600 141.732 (Note 2)	3,600 141.732 (Note 2)	3,600 141.732 (Note 2)	2,200 86.614	3,400 133.858	3,600 141.732 (Note 2)	FT-R43		3,600 141.732 (Note 2)	3,600 141.732 (Note 2)	3,600 141.732 (Note 2)	3,600 141.732 (Note 2)	3,600 141.732 (Note 2)	3,600 141.732 (Note 2)	2,670 105.181	2,670 105.181	3,600 141.732 (Note 2)	FT-H35-M2		3,600 141.732 (Note 2)	3,600 141.732 (Note 2)	3,600 141.732 (Note 2)	3,600 141.732 (Note 2)	3,600 141.732 (Note 2)	3,600 141.732 (Note 2)	3,300 129.921	1,400 55.118	3,500 137.795	FT-H20W-M1		1,600 62.992 (Note 2)	1,600 62.992 (Note 2)	1,600 62.992 (Note 2)	1,600 62.992 (Note 2)	1,600 62.992 (Note 2)	1,600 62.992 (Note 2)	850 33.465	1,300 51.181	1,600 62.992 (Note 2)	FT-H20-M1		1,600 62.992 (Note 2)	1,600 62.992 (Note 2)	1,600 62.992 (Note 2)	1,600 62.992 (Note 2)	1,600 62.992 (Note 2)	1,600 62.992 (Note 2)	1,200 47.244	1,600 62.992 (Note 2)	1,600 62.992 (Note 2)	FT-H20-J50-S		3,600 141.732 (Note 2)	3,600 141.732 (Note 2)	3,500 137.795	2,000 78.740	1,600 62.992	500 19.685	1,000 39.370	3,500 137.795 (Note 2)	FT-H20-J30-S										FT-H20-J20-S									
		Amplifier		FX-500 series						FX-100 series																																																																																																																																																								
		Fiber	Mode	HYPR	U-LG	LONG	STD	FAST	H-SP	FX-101	FX-102																																																																																																																																																							
		FT-43		3,600 141.732 (Note 2)	3,600 141.732 (Note 2)	3,600 141.732 (Note 2)	3,600 141.732 (Note 2)	3,600 141.732 (Note 2)	3,600 141.732 (Note 2)	1,600 62.992	2,400 94.488	3,600 141.732 (Note 2)																																																																																																																																																						
		FT-42		3,600 141.732 (Note 2)	3,600 141.732 (Note 2)	3,600 141.732 (Note 2)	3,600 141.732 (Note 2)	3,600 141.732 (Note 2)	3,600 141.732 (Note 2)	2,200 86.614	3,400 133.858	3,600 141.732 (Note 2)																																																																																																																																																						
		FT-42W		3,600 141.732 (Note 2)	3,600 141.732 (Note 2)	3,600 141.732 (Note 2)	3,600 141.732 (Note 2)	3,600 141.732 (Note 2)	3,600 141.732 (Note 2)	2,200 86.614	3,400 133.858	3,600 141.732 (Note 2)																																																																																																																																																						
		FT-45X		1,600 62.992 (Note 2)	1,600 62.992 (Note 2)	1,600 62.992 (Note 2)	1,600 62.992 (Note 2)	1,600 62.992 (Note 2)	1,600 62.992 (Note 2)	1,500 59.055	1,600 62.992 (Note 2)	1,600 62.992 (Note 2)																																																																																																																																																						
		FT-R40		3,600 141.732 (Note 2)	3,600 141.732 (Note 2)	3,600 141.732 (Note 2)	3,600 141.732 (Note 2)	3,600 141.732 (Note 2)	3,600 141.732 (Note 2)	3,100 122.047	3,100 122.047	3,600 141.732 (Note 2)																																																																																																																																																						
		FT-R42W		3,600 141.732 (Note 2)	3,600 141.732 (Note 2)	3,600 141.732 (Note 2)	3,600 141.732 (Note 2)	3,600 141.732 (Note 2)	3,600 141.732 (Note 2)	2,200 86.614	3,400 133.858	3,600 141.732 (Note 2)																																																																																																																																																						
		FT-R43		3,600 141.732 (Note 2)	3,600 141.732 (Note 2)	3,600 141.732 (Note 2)	3,600 141.732 (Note 2)	3,600 141.732 (Note 2)	3,600 141.732 (Note 2)	2,670 105.181	2,670 105.181	3,600 141.732 (Note 2)																																																																																																																																																						
		FT-H35-M2		3,600 141.732 (Note 2)	3,600 141.732 (Note 2)	3,600 141.732 (Note 2)	3,600 141.732 (Note 2)	3,600 141.732 (Note 2)	3,600 141.732 (Note 2)	3,300 129.921	1,400 55.118	3,500 137.795																																																																																																																																																						
		FT-H20W-M1		1,600 62.992 (Note 2)	1,600 62.992 (Note 2)	1,600 62.992 (Note 2)	1,600 62.992 (Note 2)	1,600 62.992 (Note 2)	1,600 62.992 (Note 2)	850 33.465	1,300 51.181	1,600 62.992 (Note 2)																																																																																																																																																						
FT-H20-M1		1,600 62.992 (Note 2)	1,600 62.992 (Note 2)	1,600 62.992 (Note 2)	1,600 62.992 (Note 2)	1,600 62.992 (Note 2)	1,600 62.992 (Note 2)	1,200 47.244	1,600 62.992 (Note 2)	1,600 62.992 (Note 2)																																																																																																																																																								
FT-H20-J50-S		3,600 141.732 (Note 2)	3,600 141.732 (Note 2)	3,500 137.795	2,000 78.740	1,600 62.992	500 19.685	1,000 39.370	3,500 137.795 (Note 2)																																																																																																																																																									
FT-H20-J30-S																																																																																																																																																																		
FT-H20-J20-S																																																																																																																																																																		
Super-expansion lens (Note 1)	FX-LE2	Tremendously increases the sensing range with large diameter lenses. • Ambient temperature: -60 to +350 °C -76 to +662 °F (Note 4) • Beam dia: ø9.8 mm ø0.386 in Sensing range (mm in) [Lens on both sides]																																																																																																																																																																
		<table border="1"> <thead> <tr> <th colspan="2">Amplifier</th> <th colspan="6">FX-500 series</th> <th colspan="2">FX-100 series</th> </tr> <tr> <th>Fiber</th> <th>Mode</th> <th>HYPR</th> <th>U-LG</th> <th>LONG</th> <th>STD</th> <th>FAST</th> <th>H-SP</th> <th>FX-101</th> <th>FX-102</th> </tr> </thead> <tbody> <tr> <td>FT-43</td> <td></td> <td>3,600 141.732 (Note 2)</td> <td>3,600 141.732 (Note 2)</td> <td>3,600 141.732 (Note 2)</td> <td>3,600 141.732 (Note 2)</td> <td>3,600 141.732 (Note 2)</td> <td>3,600 141.732 (Note 2)</td> <td>3,600 141.732 (Note 2)</td> <td>3,600 141.732 (Note 2)</td> </tr> <tr> <td>FT-42</td> <td></td> <td>3,600 141.732 (Note 2)</td> <td>3,600 141.732 (Note 2)</td> <td>3,600 141.732 (Note 2)</td> <td>3,600 141.732 (Note 2)</td> <td>3,600 141.732 (Note 2)</td> <td>3,600 141.732 (Note 2)</td> <td>3,600 141.732 (Note 2)</td> <td>3,600 141.732 (Note 2)</td> </tr> <tr> <td>FT-42W</td> <td></td> <td>3,600 141.732 (Note 2)</td> <td>3,600 141.732 (Note 2)</td> <td>3,600 141.732 (Note 2)</td> <td>3,600 141.732 (Note 2)</td> <td>3,600 141.732 (Note 2)</td> <td>3,600 141.732 (Note 2)</td> <td>3,600 141.732 (Note 2)</td> <td>3,600 141.732 (Note 2)</td> </tr> <tr> <td>FT-45X</td> <td></td> <td>1,600 62.992 (Note 2)</td> <td>1,600 62.992 (Note 2)</td> <td>1,600 62.992 (Note 2)</td> <td>1,600 62.992 (Note 2)</td> <td>1,600 62.992 (Note 2)</td> <td>1,600 62.992 (Note 2)</td> <td>1,600 62.992 (Note 2)</td> <td>1,600 62.992 (Note 2)</td> </tr> <tr> <td>FT-R40</td> <td></td> <td>3,600 141.732 (Note 2)</td> <td>3,600 141.732 (Note 2)</td> <td>3,600 141.732 (Note 2)</td> <td>3,600 141.732 (Note 2)</td> <td>3,600 141.732 (Note 2)</td> <td>3,600 141.732 (Note 2)</td> <td>3,600 141.732 (Note 2)</td> <td>3,600 141.732 (Note 2)</td> </tr> <tr> <td>FT-R42W</td> <td></td> <td>3,600 141.732 (Note 2)</td> <td>3,600 141.732 (Note 2)</td> <td>3,600 141.732 (Note 2)</td> <td>3,600 141.732 (Note 2)</td> <td>3,600 141.732 (Note 2)</td> <td>3,600 141.732 (Note 2)</td> <td>3,600 141.732 (Note 2)</td> <td>3,600 141.732 (Note 2)</td> </tr> <tr> <td>FT-R43</td> <td></td> <td>3,600 141.732 (Note 2)</td> <td>3,600 141.732 (Note 2)</td> <td>3,600 141.732 (Note 2)</td> <td>3,600 141.732 (Note 2)</td> <td>3,600 141.732 (Note 2)</td> <td>3,600 141.732 (Note 2)</td> <td>3,600 141.732 (Note 2)</td> <td>3,600 141.732 (Note 2)</td> </tr> <tr> <td>FT-H35-M2</td> <td></td> <td>3,600 141.732 (Note 2)</td> <td>3,600 141.732 (Note 2)</td> <td>3,600 141.732 (Note 2)</td> <td>3,600 141.732 (Note 2)</td> <td>3,600 141.732 (Note 2)</td> <td>3,600 141.732 (Note 2)</td> <td>3,500 137.795 (Note 2)</td> <td>3,500 137.795 (Note 2)</td> </tr> <tr> <td>FT-H20W-M1</td> <td></td> <td>1,600 62.992 (Note 2)</td> <td>1,600 62.992 (Note 2)</td> <td>1,600 62.992 (Note 2)</td> <td>1,600 62.992 (Note 2)</td> <td>1,600 62.992 (Note 2)</td> <td>1,600 62.992 (Note 2)</td> <td>1,600 62.992 (Note 2)</td> <td>1,600 62.992 (Note 2)</td> </tr> <tr> <td>FT-H20-M1</td> <td></td> <td>1,600 62.992 (Note 2)</td> <td>1,600 62.992 (Note 2)</td> <td>1,600 62.992 (Note 2)</td> <td>1,600 62.992 (Note 2)</td> <td>1,600 62.992 (Note 2)</td> <td>1,600 62.992 (Note 2)</td> <td>1,600 62.992 (Note 2)</td> <td>1,600 62.992 (Note 2)</td> </tr> <tr> <td>FT-H13-FM2</td> <td></td> <td>3,600 141.732 (Note 2)</td> <td>3,600 141.732 (Note 2)</td> <td>3,600 141.732 (Note 2)</td> <td>3,600 141.732 (Note 2)</td> <td>3,600 141.732 (Note 2)</td> <td>3,600 141.732 (Note 2)</td> <td>3,500 137.795 (Note 2)</td> <td>3,500 137.795 (Note 2)</td> </tr> <tr> <td>FT-H20-J50-S</td> <td></td> <td>3,600 141.732 (Note 2)</td> <td>3,600 141.732 (Note 2)</td> <td>3,600 141.732 (Note 2)</td> <td>3,600 141.732 (Note 2)</td> <td>3,600 141.732 (Note 2)</td> <td>3,600 141.732 (Note 2)</td> <td>3,500 137.795 (Note 2)</td> <td>3,500 137.795 (Note 2)</td> </tr> <tr> <td>FT-H20-J30-S</td> <td></td> <td></td> <td></td> <td></td> <td></td> <td></td> <td></td> <td></td> <td></td> </tr> <tr> <td>FT-H20-J20-S</td> <td></td> <td></td> <td></td> <td></td> <td></td> <td></td> <td></td> <td></td> <td></td> </tr> </tbody> </table>	Amplifier		FX-500 series						FX-100 series		Fiber	Mode	HYPR	U-LG	LONG	STD	FAST	H-SP	FX-101	FX-102	FT-43		3,600 141.732 (Note 2)	3,600 141.732 (Note 2)	3,600 141.732 (Note 2)	3,600 141.732 (Note 2)	3,600 141.732 (Note 2)	3,600 141.732 (Note 2)	3,600 141.732 (Note 2)	3,600 141.732 (Note 2)	FT-42		3,600 141.732 (Note 2)	3,600 141.732 (Note 2)	3,600 141.732 (Note 2)	3,600 141.732 (Note 2)	3,600 141.732 (Note 2)	3,600 141.732 (Note 2)	3,600 141.732 (Note 2)	3,600 141.732 (Note 2)	FT-42W		3,600 141.732 (Note 2)	3,600 141.732 (Note 2)	3,600 141.732 (Note 2)	3,600 141.732 (Note 2)	3,600 141.732 (Note 2)	3,600 141.732 (Note 2)	3,600 141.732 (Note 2)	3,600 141.732 (Note 2)	FT-45X		1,600 62.992 (Note 2)	1,600 62.992 (Note 2)	1,600 62.992 (Note 2)	1,600 62.992 (Note 2)	1,600 62.992 (Note 2)	1,600 62.992 (Note 2)	1,600 62.992 (Note 2)	1,600 62.992 (Note 2)	FT-R40		3,600 141.732 (Note 2)	3,600 141.732 (Note 2)	3,600 141.732 (Note 2)	3,600 141.732 (Note 2)	3,600 141.732 (Note 2)	3,600 141.732 (Note 2)	3,600 141.732 (Note 2)	3,600 141.732 (Note 2)	FT-R42W		3,600 141.732 (Note 2)	3,600 141.732 (Note 2)	3,600 141.732 (Note 2)	3,600 141.732 (Note 2)	3,600 141.732 (Note 2)	3,600 141.732 (Note 2)	3,600 141.732 (Note 2)	3,600 141.732 (Note 2)	FT-R43		3,600 141.732 (Note 2)	3,600 141.732 (Note 2)	3,600 141.732 (Note 2)	3,600 141.732 (Note 2)	3,600 141.732 (Note 2)	3,600 141.732 (Note 2)	3,600 141.732 (Note 2)	3,600 141.732 (Note 2)	FT-H35-M2		3,600 141.732 (Note 2)	3,600 141.732 (Note 2)	3,600 141.732 (Note 2)	3,600 141.732 (Note 2)	3,600 141.732 (Note 2)	3,600 141.732 (Note 2)	3,500 137.795 (Note 2)	3,500 137.795 (Note 2)	FT-H20W-M1		1,600 62.992 (Note 2)	1,600 62.992 (Note 2)	1,600 62.992 (Note 2)	1,600 62.992 (Note 2)	1,600 62.992 (Note 2)	1,600 62.992 (Note 2)	1,600 62.992 (Note 2)	1,600 62.992 (Note 2)	FT-H20-M1		1,600 62.992 (Note 2)	1,600 62.992 (Note 2)	1,600 62.992 (Note 2)	1,600 62.992 (Note 2)	1,600 62.992 (Note 2)	1,600 62.992 (Note 2)	1,600 62.992 (Note 2)	1,600 62.992 (Note 2)	FT-H13-FM2		3,600 141.732 (Note 2)	3,600 141.732 (Note 2)	3,600 141.732 (Note 2)	3,600 141.732 (Note 2)	3,600 141.732 (Note 2)	3,600 141.732 (Note 2)	3,500 137.795 (Note 2)	3,500 137.795 (Note 2)	FT-H20-J50-S		3,600 141.732 (Note 2)	3,600 141.732 (Note 2)	3,600 141.732 (Note 2)	3,600 141.732 (Note 2)	3,600 141.732 (Note 2)	3,600 141.732 (Note 2)	3,500 137.795 (Note 2)	3,500 137.795 (Note 2)	FT-H20-J30-S										FT-H20-J20-S									
		Amplifier		FX-500 series						FX-100 series																																																																																																																																																								
		Fiber	Mode	HYPR	U-LG	LONG	STD	FAST	H-SP	FX-101	FX-102																																																																																																																																																							
		FT-43		3,600 141.732 (Note 2)	3,600 141.732 (Note 2)	3,600 141.732 (Note 2)	3,600 141.732 (Note 2)	3,600 141.732 (Note 2)	3,600 141.732 (Note 2)	3,600 141.732 (Note 2)	3,600 141.732 (Note 2)																																																																																																																																																							
		FT-42		3,600 141.732 (Note 2)	3,600 141.732 (Note 2)	3,600 141.732 (Note 2)	3,600 141.732 (Note 2)	3,600 141.732 (Note 2)	3,600 141.732 (Note 2)	3,600 141.732 (Note 2)	3,600 141.732 (Note 2)																																																																																																																																																							
		FT-42W		3,600 141.732 (Note 2)	3,600 141.732 (Note 2)	3,600 141.732 (Note 2)	3,600 141.732 (Note 2)	3,600 141.732 (Note 2)	3,600 141.732 (Note 2)	3,600 141.732 (Note 2)	3,600 141.732 (Note 2)																																																																																																																																																							
		FT-45X		1,600 62.992 (Note 2)	1,600 62.992 (Note 2)	1,600 62.992 (Note 2)	1,600 62.992 (Note 2)	1,600 62.992 (Note 2)	1,600 62.992 (Note 2)	1,600 62.992 (Note 2)	1,600 62.992 (Note 2)																																																																																																																																																							
		FT-R40		3,600 141.732 (Note 2)	3,600 141.732 (Note 2)	3,600 141.732 (Note 2)	3,600 141.732 (Note 2)	3,600 141.732 (Note 2)	3,600 141.732 (Note 2)	3,600 141.732 (Note 2)	3,600 141.732 (Note 2)																																																																																																																																																							
		FT-R42W		3,600 141.732 (Note 2)	3,600 141.732 (Note 2)	3,600 141.732 (Note 2)	3,600 141.732 (Note 2)	3,600 141.732 (Note 2)	3,600 141.732 (Note 2)	3,600 141.732 (Note 2)	3,600 141.732 (Note 2)																																																																																																																																																							
		FT-R43		3,600 141.732 (Note 2)	3,600 141.732 (Note 2)	3,600 141.732 (Note 2)	3,600 141.732 (Note 2)	3,600 141.732 (Note 2)	3,600 141.732 (Note 2)	3,600 141.732 (Note 2)	3,600 141.732 (Note 2)																																																																																																																																																							
		FT-H35-M2		3,600 141.732 (Note 2)	3,600 141.732 (Note 2)	3,600 141.732 (Note 2)	3,600 141.732 (Note 2)	3,600 141.732 (Note 2)	3,600 141.732 (Note 2)	3,500 137.795 (Note 2)	3,500 137.795 (Note 2)																																																																																																																																																							
		FT-H20W-M1		1,600 62.992 (Note 2)	1,600 62.992 (Note 2)	1,600 62.992 (Note 2)	1,600 62.992 (Note 2)	1,600 62.992 (Note 2)	1,600 62.992 (Note 2)	1,600 62.992 (Note 2)	1,600 62.992 (Note 2)																																																																																																																																																							
FT-H20-M1		1,600 62.992 (Note 2)	1,600 62.992 (Note 2)	1,600 62.992 (Note 2)	1,600 62.992 (Note 2)	1,600 62.992 (Note 2)	1,600 62.992 (Note 2)	1,600 62.992 (Note 2)	1,600 62.992 (Note 2)																																																																																																																																																									
FT-H13-FM2		3,600 141.732 (Note 2)	3,600 141.732 (Note 2)	3,600 141.732 (Note 2)	3,600 141.732 (Note 2)	3,600 141.732 (Note 2)	3,600 141.732 (Note 2)	3,500 137.795 (Note 2)	3,500 137.795 (Note 2)																																																																																																																																																									
FT-H20-J50-S		3,600 141.732 (Note 2)	3,600 141.732 (Note 2)	3,600 141.732 (Note 2)	3,600 141.732 (Note 2)	3,600 141.732 (Note 2)	3,600 141.732 (Note 2)	3,500 137.795 (Note 2)	3,500 137.795 (Note 2)																																																																																																																																																									
FT-H20-J30-S																																																																																																																																																																		
FT-H20-J20-S																																																																																																																																																																		
Side-view lens	FX-SV1	Beam axis is bent by 90°. • Ambient temperature: -60 to +300 °C -76 to +572 °F (Note 4) • Beam dia: ø2.8 mm ø0.110 in Sensing range (mm in) [Lens on both sides]																																																																																																																																																																
		<table border="1"> <thead> <tr> <th colspan="2">Amplifier</th> <th colspan="6">FX-500 series</th> <th colspan="2">FX-100 series</th> </tr> <tr> <th>Fiber</th> <th>Mode</th> <th>HYPR</th> <th>U-LG</th> <th>LONG</th> <th>STD</th> <th>FAST</th> <th>H-SP</th> <th>FX-101</th> <th>FX-102</th> </tr> </thead> <tbody> <tr> <td>FT-43</td> <td></td> <td>3,600 141.732 (Note 2)</td> <td>3,400 133.858</td> <td>2,600 102.362</td> <td>1,700 66.929</td> <td>970 38.189</td> <td>310 12.205</td> <td>510 20.079</td> <td>1,400 55.118</td> </tr> <tr> <td>FT-42</td> <td></td> <td>3,600 141.732 (Note 2)</td> <td>3,600 141.732 (Note 2)</td> <td>3,600 141.732 (Note 2)</td> <td>2,100 82.677</td> <td>1,150 45.276</td> <td>370 14.567</td> <td>500 19.685</td> <td>1,700 66.929</td> </tr> <tr> <td>FT-42W</td> <td></td> <td>3,600 141.732 (Note 2)</td> <td>3,500 137.795</td> <td>2,700 106.299</td> <td>1,800 70.866</td> <td>990 38.976</td> <td>320 12.598</td> <td>480 18.898</td> <td>1,300 51.181</td> </tr> <tr> <td>FT-45X</td> <td></td> <td>1,600 62.992 (Note 2)</td> <td>1,600 62.992 (Note 2)</td> <td>1,600 62.992 (Note 2)</td> <td>1,400 55.118</td> <td>800 31.496</td> <td>210 8.268</td> <td>540 21.260</td> <td>1,600 62.992 (Note 2)</td> </tr> <tr> <td>FT-R42W</td> <td></td> <td>3,600 141.732 (Note 2)</td> <td>3,500 137.795</td> <td>2,700 106.299</td> <td>1,800 70.866</td> <td>990 38.976</td> <td>320 12.598</td> <td>480 18.898</td> <td>1,300 51.181</td> </tr> <tr> <td>FT-R43</td> <td></td> <td>3,200 125.984</td> <td>1,800 70.866</td> <td>1,300 51.181</td> <td>950 37.402</td> <td>510 20.079</td> <td>160 6.299</td> <td>310 12.205</td> <td>930 36.614</td> </tr> <tr> <td>FT-H35-M2</td> <td></td> <td>3,500 137.795</td> <td>1,600 62.992</td> <td>1,200 47.244</td> <td>780 30.709</td> <td>500 19.685</td> <td>150 5.906</td> <td>280 11.024</td> <td>800 31.496</td> </tr> <tr> <td>FT-H20W-M1</td> <td></td> <td>1,600 62.992 (Note 2)</td> <td>1,600 62.992 (Note 2)</td> <td>1,500 59.055</td> <td>950 37.402</td> <td>560 22.047</td> <td>190 7.480</td> <td>140 5.512</td> <td>400 15.748</td> </tr> <tr> <td>FT-H20-M1</td> <td></td> <td>1,600 62.992 (Note 2)</td> <td>1,600 62.992 (Note 2)</td> <td>1,300 51.181</td> <td>780 30.709</td> <td>500 19.685</td> <td>150 5.906</td> <td>280 11.024</td> <td>330 13.071</td> </tr> <tr> <td>FT-H20-J50-S</td> <td></td> <td></td> <td></td> <td></td> <td></td> <td></td> <td></td> <td></td> <td></td> </tr> <tr> <td>FT-H20-J30-S</td> <td></td> <td></td> <td></td> <td></td> <td></td> <td></td> <td></td> <td></td> <td></td> </tr> <tr> <td>FT-H20-J20-S</td> <td></td> <td></td> <td></td> <td></td> <td></td> <td></td> <td></td> <td></td> <td></td> </tr> </tbody> </table>	Amplifier		FX-500 series						FX-100 series		Fiber	Mode	HYPR	U-LG	LONG	STD	FAST	H-SP	FX-101	FX-102	FT-43		3,600 141.732 (Note 2)	3,400 133.858	2,600 102.362	1,700 66.929	970 38.189	310 12.205	510 20.079	1,400 55.118	FT-42		3,600 141.732 (Note 2)	3,600 141.732 (Note 2)	3,600 141.732 (Note 2)	2,100 82.677	1,150 45.276	370 14.567	500 19.685	1,700 66.929	FT-42W		3,600 141.732 (Note 2)	3,500 137.795	2,700 106.299	1,800 70.866	990 38.976	320 12.598	480 18.898	1,300 51.181	FT-45X		1,600 62.992 (Note 2)	1,600 62.992 (Note 2)	1,600 62.992 (Note 2)	1,400 55.118	800 31.496	210 8.268	540 21.260	1,600 62.992 (Note 2)	FT-R42W		3,600 141.732 (Note 2)	3,500 137.795	2,700 106.299	1,800 70.866	990 38.976	320 12.598	480 18.898	1,300 51.181	FT-R43		3,200 125.984	1,800 70.866	1,300 51.181	950 37.402	510 20.079	160 6.299	310 12.205	930 36.614	FT-H35-M2		3,500 137.795	1,600 62.992	1,200 47.244	780 30.709	500 19.685	150 5.906	280 11.024	800 31.496	FT-H20W-M1		1,600 62.992 (Note 2)	1,600 62.992 (Note 2)	1,500 59.055	950 37.402	560 22.047	190 7.480	140 5.512	400 15.748	FT-H20-M1		1,600 62.992 (Note 2)	1,600 62.992 (Note 2)	1,300 51.181	780 30.709	500 19.685	150 5.906	280 11.024	330 13.071	FT-H20-J50-S										FT-H20-J30-S										FT-H20-J20-S																													
		Amplifier		FX-500 series						FX-100 series																																																																																																																																																								
		Fiber	Mode	HYPR	U-LG	LONG	STD	FAST	H-SP	FX-101	FX-102																																																																																																																																																							
		FT-43		3,600 141.732 (Note 2)	3,400 133.858	2,600 102.362	1,700 66.929	970 38.189	310 12.205	510 20.079	1,400 55.118																																																																																																																																																							
		FT-42		3,600 141.732 (Note 2)	3,600 141.732 (Note 2)	3,600 141.732 (Note 2)	2,100 82.677	1,150 45.276	370 14.567	500 19.685	1,700 66.929																																																																																																																																																							
		FT-42W		3,600 141.732 (Note 2)	3,500 137.795	2,700 106.299	1,800 70.866	990 38.976	320 12.598	480 18.898	1,300 51.181																																																																																																																																																							
		FT-45X		1,600 62.992 (Note 2)	1,600 62.992 (Note 2)	1,600 62.992 (Note 2)	1,400 55.118	800 31.496	210 8.268	540 21.260	1,600 62.992 (Note 2)																																																																																																																																																							
		FT-R42W		3,600 141.732 (Note 2)	3,500 137.795	2,700 106.299	1,800 70.866	990 38.976	320 12.598	480 18.898	1,300 51.181																																																																																																																																																							
		FT-R43		3,200 125.984	1,800 70.866	1,300 51.181	950 37.402	510 20.079	160 6.299	310 12.205	930 36.614																																																																																																																																																							
		FT-H35-M2		3,500 137.795	1,600 62.992	1,200 47.244	780 30.709	500 19.685	150 5.906	280 11.024	800 31.496																																																																																																																																																							
		FT-H20W-M1		1,600 62.992 (Note 2)	1,600 62.992 (Note 2)	1,500 59.055	950 37.402	560 22.047	190 7.480	140 5.512	400 15.748																																																																																																																																																							
		FT-H20-M1		1,600 62.992 (Note 2)	1,600 62.992 (Note 2)	1,300 51.181	780 30.709	500 19.685	150 5.906	280 11.024	330 13.071																																																																																																																																																							
FT-H20-J50-S																																																																																																																																																																		
FT-H20-J30-S																																																																																																																																																																		
FT-H20-J20-S																																																																																																																																																																		
Expansion lens for vacuum fiber (Note 1)	FV-LE1	Sensing range increases by 4 times or more. • Ambient temperature: -60 to +350 °C -76 to +662 °F (Note 4) • Beam dia: ø3.6 mm ø0.142 in Sensing range (mm in) [Lens on both sides] (Note 3)																																																																																																																																																																
		<table border="1"> <thead> <tr> <th colspan="2">Amplifier</th> <th colspan="6">FX-500 series</th> <th colspan="2">FX-100 series</th> </tr> <tr> <th>Fiber</th> <th>Mode</th> <th>HYPR</th> <th>U-LG</th> <th>LONG</th> <th>STD</th> <th>FAST</th> <th>H-SP</th> <th>FX-101</th> <th>FX-102</th> </tr> </thead> <tbody> <tr> <td>FT-H30-M1V-S</td> <td></td> <td>3,600 141.732 (Note 2)</td> <td>3,600 141.732 (Note 2)</td> <td>3,400 133.858</td> <td>1,500 59.055</td> <td>900 35.433</td> <td>370 14.567</td> <td>450 17.717</td> <td>1,600 62.992</td> </tr> </tbody> </table>	Amplifier		FX-500 series						FX-100 series		Fiber	Mode	HYPR	U-LG	LONG	STD	FAST	H-SP	FX-101	FX-102	FT-H30-M1V-S		3,600 141.732 (Note 2)	3,600 141.732 (Note 2)	3,400 133.858	1,500 59.055	900 35.433	370 14.567	450 17.717	1,600 62.992																																																																																																																																		
Amplifier		FX-500 series						FX-100 series																																																																																																																																																										
Fiber	Mode	HYPR	U-LG	LONG	STD	FAST	H-SP	FX-101	FX-102																																																																																																																																																									
FT-H30-M1V-S		3,600 141.732 (Note 2)	3,600 141.732 (Note 2)	3,400 133.858	1,500 59.055	900 35.433	370 14.567	450 17.717	1,600 62.992																																																																																																																																																									
Vacuum-resistant side-view lens (Note 1)	FV-SV2	Beam axis is bent by 90°. • Ambient temperature: -60 to +300 °C -76 to +572 °F (Note 4) • Beam dia: ø3.7 mm ø0.146 in Sensing range (mm in) [Lens on both sides] (Note 3)																																																																																																																																																																
		<table border="1"> <thead> <tr> <th colspan="2">Amplifier</th> <th colspan="6">FX-500 series</th> <th colspan="2">FX-100 series</th> </tr> <tr> <th>Fiber</th> <th>Mode</th> <th>HYPR</th> <th>U-LG</th> <th>LONG</th> <th>STD</th> <th>FAST</th> <th>H-SP</th> <th>FX-101</th> <th>FX-102</th> </tr> </thead> <tbody> <tr> <td>FT-H30-M1V-S</td> <td></td> <td>3,600 141.732 (Note 2)</td> <td>3,600 141.732 (Note 2)</td> <td>3,400 133.858</td> <td>1,500 59.055</td> <td>900 35.433</td> <td>370 14.567</td> <td>450 17.717</td> <td>1,600 62.992</td> </tr> </tbody> </table>	Amplifier		FX-500 series						FX-100 series		Fiber	Mode	HYPR	U-LG	LONG	STD	FAST	H-SP	FX-101	FX-102	FT-H30-M1V-S		3,600 141.732 (Note 2)	3,600 141.732 (Note 2)	3,400 133.858	1,500 59.055	900 35.433	370 14.567	450 17.717	1,600 62.992																																																																																																																																		
Amplifier		FX-500 series						FX-100 series																																																																																																																																																										
Fiber	Mode	HYPR	U-LG	LONG	STD	FAST	H-SP	FX-101	FX-102																																																																																																																																																									
FT-H30-M1V-S		3,600 141.732 (Note 2)	3,600 141.732 (Note 2)	3,400 133.858	1,500 59.055	900 35.433	370 14.567	450 17.717	1,600 62.992																																																																																																																																																									

- Notes: 1) Be careful sure to use it only after you have adjusted it sufficiently when installing the thru-beam type fiber equipped with the expansion lens, as the beam envelope becomes narrow and alignment is difficult.
2) The fiber cable length practically limits the sensing range.
3) The fiber cable length for the FT-H30-M1V-S is 1 m 3.28 ft. The sensing ranges in HYPR, U-LG and LONG of FX-500 series and in FX-102 are specified considering the length of the FT-J8 atmospheric side fiber.
4) Refer to p.12, p.15, p.30 and p.32 for the ambient temperature of fibers to be used in combination.

FIBER OPTIONS





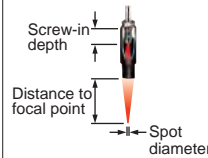
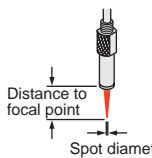
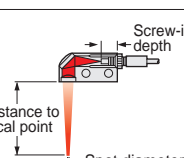
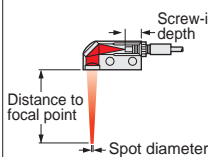



Refer to p.66~ for details of lens dimensions.

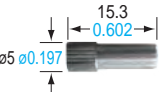

Lens (For reflective type fiber)

Designation	Model No.	Description	
For reflective type fiber	Pinpoint spot lens FX-MR1		Pinpoint spot of $\varnothing 0.5$ mm $\varnothing 0.020$ in. Enables detection of minute objects or small marks. • Distance to focal point: 6 ± 1 mm 0.236 ± 0.039 in • Applicable fibers: FD-42G, FD-42GW • Ambient temperature: -40 to $+70$ °C -40 to $+158$ °F (Note)
	Zoom lens FX-MR2		The spot diameter is adjustable from $\varnothing 0.7$ to $\varnothing 2$ mm $\varnothing 0.028$ to $\varnothing 0.079$ in according to how much the fiber is screwed in. • Applicable fibers: FD-42G, FD-42GW • Ambient temperature: -40 to $+70$ °C -40 to $+158$ °F (Note) • Accessory: MS-EX3 (mounting bracket) Sensing range for FX-500/FX-100 series
	Finest spot lens FX-MR3		Extremely fine spot of $\varnothing 0.15$ mm $\varnothing 0.006$ in approx. achieved. • Applicable fibers: FD-EG31, FD-EG30, FD-42G, FD-42GW, FD-32G, FD-32GX • Ambient temperature: -40 to $+70$ °C -40 to $+158$ °F (Note) Sensing range for FX-500/FX-100 series
	Finest spot lens FX-MR6		Extremely fine spot of $\varnothing 0.1$ mm $\varnothing 0.004$ in approx. achieved. • Applicable fibers: FD-EG31, FD-EG30, FD-42G, FD-42GW, FD-32G, FD-32GX • Ambient temperature: -20 to $+60$ °C -4 to $+140$ °F (Note) Sensing range for FX-500/FX-100 series
	Zoom lens (side-view type) FX-MR5		FX-MR2 is converted into a side-view type and can be mounted in a very small space. • Applicable fibers: FD-42G, FD-42GW • Ambient temperature: -40 to $+70$ °C -40 to $+158$ °F (Note) Sensing range for FX-500/FX-100 series

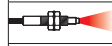
Note: Refer to p.13 or p.23 for the ambient temperature of fibers to be used in combination.

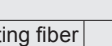
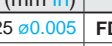
Lens (For square head M3 reflective fiber)

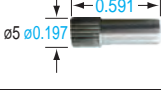
Type	Spot diameter (mm in)	Distance to focal point (mm in)	Lens		Fiber	
			Shape (mm in)	Model No.	Shape	Emitting fiber core (mm in) Model No.
For Square head M3 reflective fiber Finest spot lens	$\varnothing 0.1$ $\varnothing 0.004$ approx.	7 ± 0.5 0.276 ± 0.020		FX-MR7		$\varnothing 0.125$ $\varnothing 0.005$ FD-R33EG
	$\varnothing 0.15$ $\varnothing 0.006$ approx.					$\varnothing 0.125$ $\varnothing 0.005$ FD-EG31
	$\varnothing 0.2$ $\varnothing 0.008$ approx.					$\varnothing 0.175$ $\varnothing 0.007$ FD-R34EG
	$\varnothing 0.4$ $\varnothing 0.016$ approx.					$\varnothing 0.25$ $\varnothing 0.010$ FD-R32EG
						$\varnothing 0.25$ $\varnothing 0.010$ FD-EG30
						$\varnothing 0.5$ $\varnothing 0.020$ FD-R31G
						$\varnothing 0.5$ $\varnothing 0.020$ FD-32G
						$\varnothing 0.5$ $\varnothing 0.020$ FD-32GX
						$\varnothing 0.5$ $\varnothing 0.020$ FD-42G
						$\varnothing 0.5$ $\varnothing 0.020$ FD-42GW

Type	Spot diameter (mm in)	Sensing range (mm in)	Lens		Applicable fibers	
			Shape (mm in)	Model No.	Emitting fiber core (mm in)	Model No.
For Square head M3 reflective fiber Zoom lens	$\varnothing 0.4$ to $\varnothing 2.0$ $\varnothing 0.016$ to $\varnothing 0.079$ approx.	10 to 30 0.394 to 1.181		FX-MR8	$\varnothing 0.125$ $\varnothing 0.005$	FD-R33EG, FD-EG31
	$\varnothing 0.4$ to $\varnothing 2.2$ $\varnothing 0.016$ to $\varnothing 0.087$ approx.				$\varnothing 0.175$ $\varnothing 0.007$	FD-R34EG
	$\varnothing 0.5$ to $\varnothing 2.5$ $\varnothing 0.020$ to $\varnothing 0.098$ approx.				$\varnothing 0.25$ $\varnothing 0.010$	FD-R32EG, FD-EG30
	$\varnothing 0.8$ to $\varnothing 3.5$ $\varnothing 0.031$ to $\varnothing 0.138$ approx.				$\varnothing 0.5$ $\varnothing 0.020$	FD-R31G, FD-32G, FD-32GX, FD-42G, FD-42GW
Parallel light lens	$\varnothing 4.0$ $\varnothing 0.157$ approx.	0 to 30 0 to 1.181		FX-MR9	$\varnothing 0.125$ $\varnothing 0.005$	FD-R33EG, FD-EG31
					$\varnothing 0.175$ $\varnothing 0.007$	FD-R34EG
					$\varnothing 0.25$ $\varnothing 0.010$	FD-R32EG, FD-EG30
					$\varnothing 0.5$ $\varnothing 0.020$	FD-R31G, FD-32G, FD-32GX, FD-42G, FD-42GW

New product introduction
Tough Fiber

Fiber Selection Guide
Model
Choose by shape/application
How to read Model No.
Earlier models comparison table

Fibers
Super Quality
Threaded Type
Square Head Type
Cylindrical Type
Sleeve
Flat Type
Small Spot
Narrow Beam
Wide Beam
Convergent Reflective Type
Retroreflective Type
Chemical / Oil-resistant
Heat-resistant
Vacuum-resistant
Liquid Leak / Liquid Detection

Fiber Options

Semi-custom fibers

Fiber Dimensions
Thru-beam Type
Retroreflective Type
Reflective Type
Others

Amplifiers
FX-500 series
FX-100 series

INDEX

FIBER OPTIONS

Model No. when ordering heat-resistant fibers individually as replacement parts

- FT-H20-J20 (one pair set)
- FT-H20-J30 (one pair set)
- FT-H20-J50 (one pair set)
- FT-H20-VJ50 (one pair set)
- FT-H20-VJ80 (one pair set)

Model No. when ordering vacuum-resistant fibers individually as replacement parts

- Vacuum-resistant fiber
FT-H30-M1V (one pair set)
FD-H30-KZ1V
FD-H30-L32V
- Photo-terminal
FV-BR1 (one pair set)
- Mouting bracket for **FD-H30-KZ1V(-S)**
MS-FD-2
- Fiber at atmospheric side
FT-J8 (one pair set)

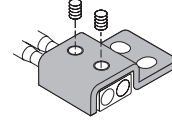

Model No. when ordering accessories additionally

- **RF-003** (**FR-KZ50E/KZ50H** exclusive reflector)
- **RF-13** (**FR-Z50HW** reflective tape)
- **FX-CT2** (Fiber cutter)
- **FX-CT3** (**FD-H40Y/F41Y** fiber cutter)
- **FX-AT2** (Attachment for fixed-length fiber, Orange)
- **FX-AT3** (Attachment for $\varnothing 2.2$ mm $\varnothing 0.087$ in fiber, Clear orange)
- **FX-AT4** (Attachment for $\varnothing 1$ mm $\varnothing 0.039$ in fiber, Black)
- **FX-AT5** (Attachment for $\varnothing 1.3$ mm $\varnothing 0.051$ in fiber, Gray)
- **FX-AT6** (Attachment for $\varnothing 1$ mm $\varnothing 0.039$ in / $\varnothing 1.3$ mm $\varnothing 0.051$ in mixed fiber, Black / Gray)
- **MS-FD-2** (Fiber mounting bracket)

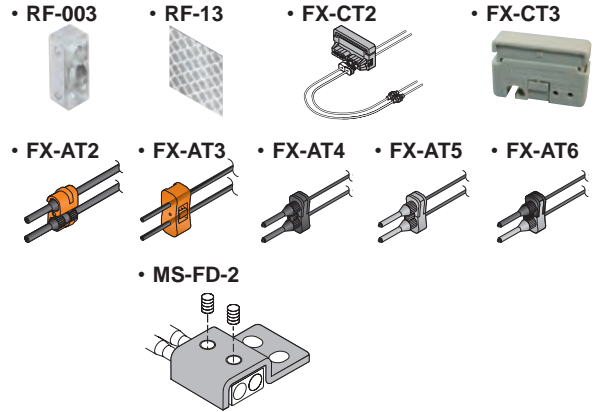

New product introduction
Tough Fiber

Fiber Selection Guide
Model
Choose by shape/application
How to read Model No
Earlier models comparison table

Fibers
Super Quality
Threaded Type
Square Head Type
Cylindrical Type
Sleeve
Flat Type
Small Spot
Narrow Beam
Wide Beam
Convergent Reflective Type
Retroreflective Type
Chemical / Oil-resistant
Heat-resistant
Vacuum-resistant
Liquid Leak / Liquid Detection

Fiber Options

Semi-custom fibers

Fiber Dimensions
Thru-beam Type
Retroreflective Type
Reflective Type
Others

Amplifiers
FX-500 series
FX-100 series

INDEX

FIBER OPTIONS

Others

Designation	Model No.	Description				
Protective tube for thru-beam type fiber	FTP-500 (0.5 m 1.640 ft)	For M4 thread	Applicable fibers	FT-42	FT-43	The protective tube, made of non-corrosive stainless steel, protects the inner fiber cable from any external forces.
	FTP-1000 (1 m 3.281 ft)			FT-42S	FT-H13-FM2	
	FTP-1500 (1.5 m 4.921 ft)			FT-42W		
	FTP-N500 (0.5 m 1.640 ft)	For M3 thread		FT-31	FD-31	
	FTP-N1000 (1 m 3.281 ft)			FT-31S	FD-31W	
	FTP-N1500 (1.5 m 4.921 ft)			FT-31W		
Protective tube for reflective type fiber	FDP-500 (0.5 m 1.640 ft)	For M6 thread	FD-61	FD-62		
	FDP-1000 (1 m 3.281 ft)		FD-61G	FD-H13-FM2		
	FDP-1500 (1.5 m 4.921 ft)		FD-61S			
	FDP-N500 (0.5 m 1.640 ft)	For M4 thread	FD-41	FD-41S		
	FDP-N1000 (1 m 3.281 ft)		FD-41W	FD-41SW		
	FDP-N1500 (1.5 m 4.921 ft)					
Fiber bender	FB-1	The fiber bender bends the sleeve part of the fiber head at the proper radius. (Note 1)				
Universal sensor mounting stand (Note 2)	MS-AJ1-F	Horizontal mounting type	Mounting stand assembly for fiber (For M3, M4 or M6 threaded head fiber)			
	MS-AJ2-F	Vertical mounting type				
Liquid inflow prevention joint (Note 2)	MS-FX-01Y	Applicable fibers	FD-HF40Y FD-F41Y	This joint suppresses false operations due to liquid slip-in from the top of the protective tube.		
Protective tube extension joint (Note 2)	MS-FX-02Y			The protective tube can be extended.		
Fiber mounting joint (Note 2)	MS-FX-03Y			The joint is used for mounting fibers on a tank.		
Single core holder	FX-AT15A			The incident light intensity may vary when using a multi-core fiber or a thin type sharp bending fiber. This holder suppresses the variation in the incident light intensity. (Brown)		
Reflector	RF-210	Used with FR-Z50HW.				
	RF-220	Refer to p.27 or p.38 for the sensing range of FR-Z50HW to be used in combination.				
	RF-230					

Notes: 1) Do not bend the sleeve part of any side-view type fiber or ultra-small diameter head type fiber.
2) The joint internal ferrule (MS-FX-YF) is available as a spare part. A distorted ferrule may result in leakage.

Liquid inflow prevention joint

- MS-FX-01Y

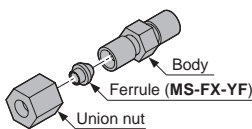

Protective tube extension joint

- MS-FX-02Y

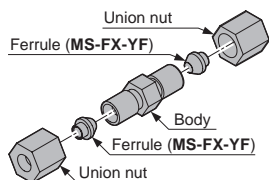

Fiber mounting joint

- MS-FX-03Y

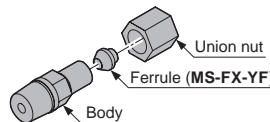

Reflector

- RF-210

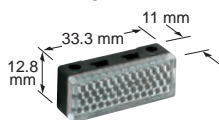

- RF-220



- RF-230

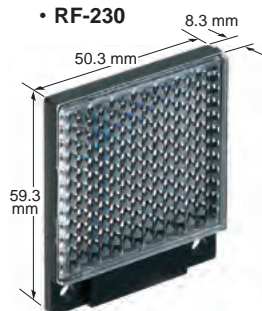

Protective tube

- FTP-□
- FDP-□



Fiber bender

- FB-1

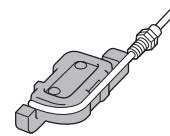

Universal sensor mounting stand

Using the arm which enables adjustment in the horizontal direction, sensing can also be done from above an assembly line.

- MS-AJ1-F

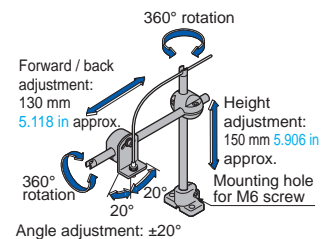

- MS-AJ2-F

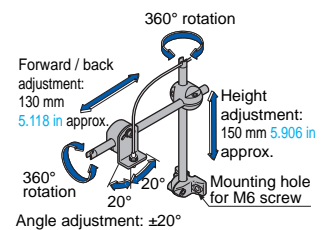

Single core holder

- FX-AT15A



New product introduction

Tough Fiber

Fiber Selection Guide

Model

Choose by shape/application

How to read Model No.

Earlier models comparison table

Fibers

Super Quality

Threaded Type

Square Head Type

Cylindrical Type

Sleeve

Flat Type

Small Spot

Narrow Beam

Wide Beam

Convergent Reflective Type

Retroreflective Type

Chemical / Oil-resistant

Heat-resistant

Vacuum-resistant

Liquid Leak / Liquid Detection

Fiber Options

Semi-custom fibers

Fiber Dimensions

Thru-beam Type

Retroreflective Type

Reflective Type

Others

Amplifiers

FX-500 series

FX-100 series

INDEX

Semi-custom fibers that flexibly meet diverse needs

Guide to interchanging fiber length and sleeve length

Custom-ordered products are available with different fiber lengths and sleeve lengths in order to respond quickly to different requirements. Contact us more in formation.

Fiber length change

It is possible to extend up to 30 m **98.425 ft** in units of 1 m **3.281 ft**, varying depending on the model. Refer to the table on the next page for applicable models.

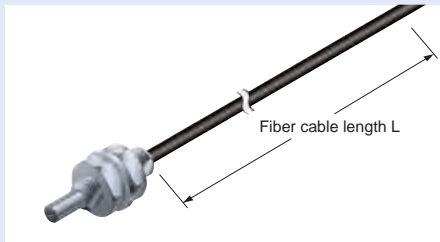

Note that the model number differs from previous models with changed lengths.

Sleeve length change

Extension is possible up to 120 mm **4.724 in** in units of 10 mm **0.394 in**. Applicable models are sleeve extension-type models indicated by ▲ in the table on the next page.

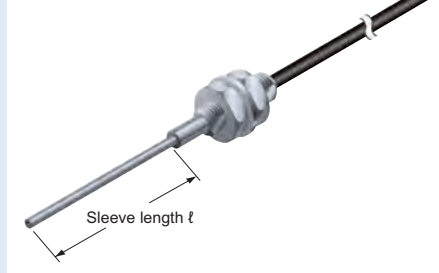

Note that the model number differs from previous models with changed lengths.

• Attenuation ratio characteristics for fiber cable length and sensing range

Note that the longer the fiber cable length, the shorter the sensing range.

Typical example: Bending radius R4 mm/R2 mm (Tough fiber)

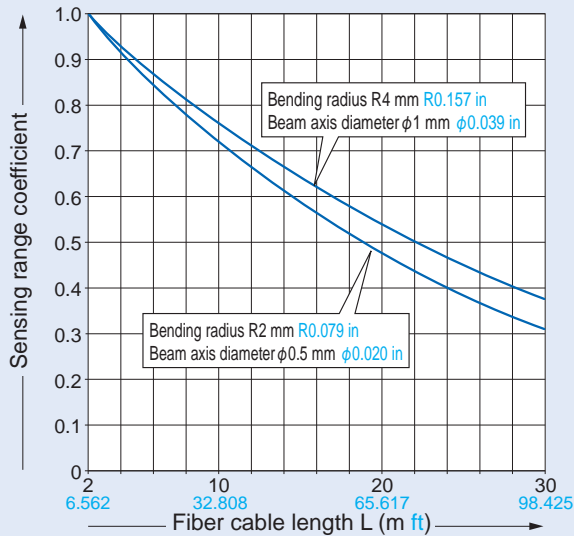

Typical example: Bending radius R1 mm (Sharp bending fiber FT-□W/FD-□W)

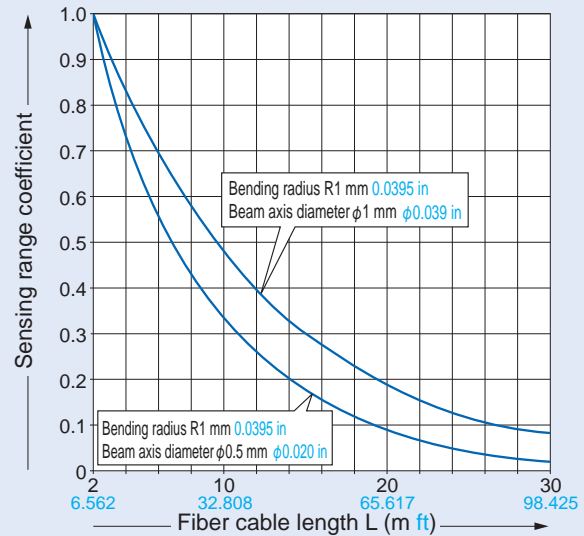

Note: Because infrared types are easily affected by humidity, please ask assistance when using them in a humid environment or in an environment with varying humidity.

Extended protective tube

The chemical-resistant cover and stainless jacket can be extended in accordance with the fiber cable length. Applicable models are indicated in the table as follows.

- ★: Models which can have extended protective tube (fluorine resin)
- ☆: Models which can have extended stainless jacket sheath

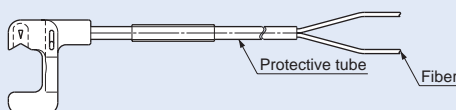

New product introduction
Tough Fiber

Fiber Selection Guide

Model
Choose by shape/application
How to read Model No
Earlier models comparison table

Fibers

Super Quality
Threaded Type
Square Head Type
Cylindrical Type

Sleeve

Flat Type
Small Spot
Narrow Beam
Wide Beam

Convergent Reflective Type
Retroreflective Type
Chemical / Oil-resistant
Heat-resistant
Vacuum-resistant
Liquid Leak / Liquid Detection

Fiber Options

Semi-custom fibers

Fiber Dimensions

Thru-beam Type
Retroreflective Type
Reflective Type

Others

Amplifiers

FX-500 series
FX-100 series

INDEX

Applicable models

Thru-beam type

Model No.	Basic specifications				Applicable fiber length	
	Fiber cable length Free-cut	Protective tube extension length	Sleeve length (mm)	Sensing range (mm) FX-500 series (STD)(Note 1)	Max. (m)	Unit (m)
FT-140	10 m	—	—	19,600 (Note 2)	30	1
FT-31	2 m	—	—	315	30	1
▲FT-31S	2 m	—	40 (Note 3)	315	30	1
FT-31W	2 m	—	—	260	20	1
FT-42	2 m	—	—	1,130	30	1
▲FT-42S	2 m	—	40 (Note 3)	1,130	30	1
FT-42W	2 m	—	—	800	30	1
FT-43	2 m	—	—	1,400	30	1
FT-45X	1 m	—	—	1,200	10	0.5
FT-A11	2 m	—	—	3,600 (Note 2)	10	1
FT-A11W	2 m	—	—	3,600 (Note 2)	10	1
FT-A32	2 m	—	—	3,600 (Note 2)	10	1
FT-A32W	2 m	—	—	3,600 (Note 2)	10	1
FT-AL05	2 m	—	—	860	20	1
FT-E13	1 m	—	5	15	10	0.5
FT-E23	1 m	—	5	75	10	0.5
★FT-F93	2 m	1 m (Note 4)	—	—	30	1
FT-H13-FM2	2 m	—	—	700	30	1
FT-H20-J50-S	500 mm	—	—	470	6.5	0.1
FT-H20-M1	1 m	—	—	540	6.5	0.1
FT-H20-VJ80-S	800 mm	—	—	600	6.5	0.1
FT-H20W-M1	1 m	—	—	470	6.5	0.1
FT-H30-M1V-S	1 m	—	—	270	6.5	0.1
FT-H35-M2	2 m	—	—	430	6.5	0.1
FT-H35-M2S6	2 m	—	—	430	6.5	0.1
★FT-HL80Y	2 m	1.5 m (Note 4)	—	3,600 (Note 2)	30	1
FT-KS40	2 m	—	—	3,600 (Note 2)	10	1
FT-KV26	2 m	—	—	710	10	1
FT-KV40	2 m	—	—	3,600 (Note 2)	10	1
FT-KV40W	2 m	—	—	3,600 (Note 2)	10	1
★FT-L80Y	2 m	1.5 m (Note 4)	—	3,600 (Note 2)	30	1
FT-R31	2 m	—	—	270	30	1
FT-R43	2 m	—	—	720	30	1
FT-R40	2 m	—	—	930	30	1
FT-R41W	2 m	—	—	800	30	1
FT-R42W	2 m	—	—	2,200	30	1
FT-R44Y	2 m	—	—	720	30	1
FT-R60Y	2 m	—	—	2,100	30	1
FT-S11	500 mm	—	—	90	30	1
FT-S21	2 m	—	—	315	30	1
FT-S21W	2 m	—	—	260	20	1
FT-S31W	2 m	—	—	800	30	1
FT-S32	2 m	—	—	3,100	30	1
FT-V23	2 m	—	20	450	30	1
FT-V24W	2 m	—	15	110	10	1
FT-V25	2 m	—	15	240	30	1
FT-V30	2 m	—	20	680	30	1
FT-V40	2 m	—	—	3,500	30	1
★FT-V80Y	2 m	1.5 m (Note 4)	—	3,600 (Note 2)	30	1
FT-Z20HBW	1 m	—	—	260	20	1
FT-Z20W	1 m	—	—	620	20	1
FT-Z30	2 m	—	—	2,100	30	1
FT-Z30E	2 m	—	—	3,500	30	1
FT-Z30EW	2 m	—	—	3,400	20	1
FT-Z30H	2 m	—	—	3,500	30	1
FT-Z30HW	2 m	—	—	3,500	20	1
FT-Z30W	2 m	—	—	1,500	20	1
FT-Z40HBW	2 m	—	—	800	20	1
FT-Z40W	2 m	—	—	1,500	20	1
FT-Z802Y	2 m	—	—	3,100	30	1

Retroreflective type

Model No.	Basic specifications				Applicable fiber length	
	Fiber cable length Free-cut	Protective tube extension length	Sleeve length (mm)	Sensing range (mm) FX-500 series (STD)(Note 1)	Max. (m)	Unit (m)
FR-KZ22E	2 m	—	—	15 to 310	10	1
FR-KZ50E	2 m	—	—	20 to 300	10	1
FR-KZ50H	2 m	—	—	20 to 300	10	1
FR-Z50HW	2 m	—	—	100 to 990	30	1

▲: Models which can have extended sleeve

★: Models which can have extended protective tube (fluorine resin)

☆: Models which can have extended stainless jacket sheath

Notes: 1) Note that the sensing range of the free-cut type fiber may be reduced by 20% max. depending upon how the fiber is cut.

2) The fiber cable length practically limits the sensing range.

3) Applicable sleeve length is from 10 to 120 mm **0.394 to 4.724 in** and in units of 10 mm **0.394 in**.4) Applicable protective length is up to 10 m **32.808 ft** and in units of 0.5 m **1.640 ft**. (however, **FD-32GX** is in units of 0.1 m **0.328 ft**.)5) Fiber length (fixed-length) for heat-resistant fiber side. Fiber length for ordinary temperature side is 2 m **6.562 ft** (free-cut).6) The allowable cutting range is 500 mm **19.685 in** from the end that the amplifier inserted.

Reflective type

Model No.	Basic specifications				Applicable fiber length	
	Fiber cable length Free-cut	Protective tube extension length	Sleeve length (mm)	Sensing range (mm) FX-500 series (STD)(Note 1)	Max. (m)	Unit (m)
FD-31	2 m	—	—	125	30	1
FD-31W	2 m	—	—	80	20	1
FD-32G	2 m	—	—	200	30	1
☆FD-32GX	1 m	300 mm (Note 4)	—	200	30	1
FD-41	2 m	—	—	125	30	1
▲FD-41S	2 m	—	40 (Note 3)	125	30	1
▲FD-41SW	2 m	—	40 (Note 3)	80	20	1
FD-41W	2 m	—	—	270	20	1
FD-42G	2 m	—	—	200	30	1
FD-42GW	2 m	—	—	150	20	1
FD-61	2 m	—	—	450	30	1
FD-61G	2 m	—	—	420	30	1
▲FD-61S	2 m	—	40 (Note 3)	420	30	1
FD-61W	2 m	—	—	270	30	1
FD-62	2 m	—	—	520	30	1
FD-64X	1 m	—	—	280	10	0.5
FD-A16	2 m	—	—	200	30	1
FD-AL11	2 m	—	—	320	20	1
FD-E13	1 m	—	3	12	3	0.1
FD-E23	1 m	—	5	55	3	0.1
FD-EG30	500 mm	—	—	48	3	0.1
FD-EG30S	1 m	—	15	50	3	0.1
FD-EG31	500 mm	—	—	20	3	0.1
FD-F4	2 m	—	—	—	10	1
FD-F41	2 m	—	—	—	10	1
★FD-F71	5 m	3 m (Note 4)	—	—	20	1
FD-FA93	2 m	—	—	—	10	1
FD-H13-FM2	2 m	—	—	350	30	1
FD-H18-L31	2 m	—	—	16	5	1
FD-H20-21	1 m	—	—	230	6.5	0.1
FD-H20-M1	1 m	—	—	330	6.5	0.1
FD-H25-L43	3 m	—	—	1.5 to 26	6.5	0.1
FD-H25-L45	3 m	—	—	5 to 42	6.5	0.1
FD-H30-KZ1V-S	1 m	—	—	20 to 200	6.5	0.1
FD-H30-L32	2 m	—	—	17	5	1
FD-H30-L32V-S	3 m	—	—	8	6.5	0.1
FD-H35-20S	1 m	—	—	260	6.5	0.1
FD-H35-M2	2 m	—	—	260	6.5	0.1
FD-H35-M2S6	2 m	—	—	260	6.5	0.1
FD-L10	2 m	—	—	0 to 5	5	1
FD-L11	2 m	—	—	0 to 9.5	5	1
FD-L12W	1 m	—	—	8	5	1
FD-L20H	2 m	—	—	30	5	1
FD-L21	2 m	—	—	1.5 to 16	5	1
FD-L21W	2 m	—	—	3 to 14	5	1
FD-L22A	2 m	—	—	0 to 24	5	1
FD-L23	3 m	—	—	0 to 29	5	1
FD-L30A	3 m	—	—	0 to 43	5	1
FD-L31A	3 m	—	—	4 to 33	5	1
FD-L32H	4 m	—	—	0 to 56	5	1
FD-R31G	2 m	—	—	170	30	1
FD-R32EG	500 mm	—	—	45	3	0.1
FD-R33EG	500 mm	—	—	19	3	0.1
FD-R34EG	500 mm	—	—	38	3	0.1
FD-R41	2 m	—	—	210	30	1
FD-R60	2 m	—	—	290	30	1
FD-R61Y	2 m	—	—	280	30	1
FD-S21	1 m	—	—	80	20	1
FD-S31	2 m	—	—	125	30	1
FD-S32	2 m	—	—	420	30	1
FD-S32W	2 m	—	—	270	20	1
FD-S33GW	2 m	—	—	150	20	1
FD-S60Y	2 m	1.5 m (Note 4)	—	320	30	1
FD-V30	2 m	—	15	65	30	1
FD-V30W	2 m	—	15	20	10	1
FD-V50	2 m	—	20	120	30	1
FD-Z20HBW	1 m	—	—	2 to 85	20	1
FD-Z20W	1 m	—	—	1 to 65	20	1
FD-Z40HBW	2 m	—	—	260	20	1
FD-Z40W	2 m	—	—	190	20	1
FD-Z50HW	2 m	—	—	10 to 650	30	1

DIMENSIONS (Unit: mm in)

Refer to the FX-500 series (p.96), FX-100 series (p.110) for dimensions of the amplifiers. The CAD data in the dimensions can be downloaded from our website.

Thru-beam type fibers



Dimensions are listed in the order of thru-beam type, retroreflective type, and reflective type, and in alphabetic order of the Model No.

FT-140

Free-cut

<with FX-AT3>

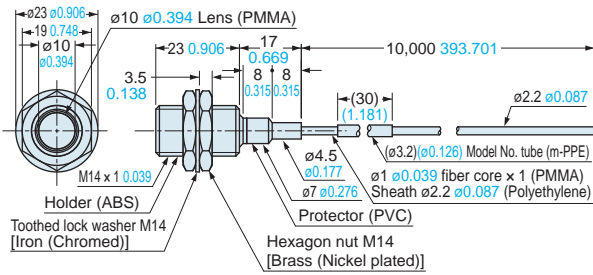

FT-30

<with FX-AT2>

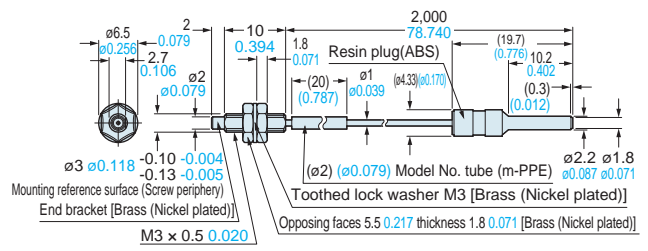

FT-31

Free-cut

<with FX-AT4>

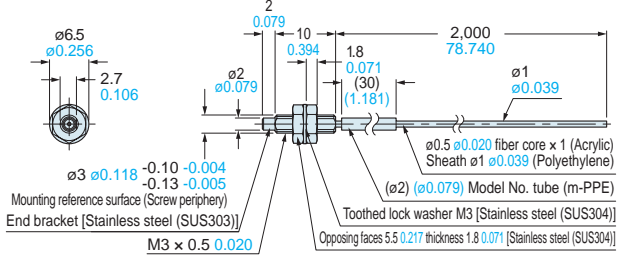

FT-31S

Free-cut

<with FX-AT4>

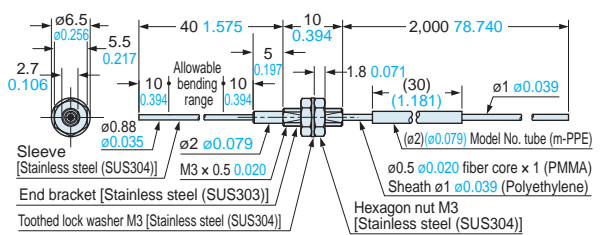

FT-31W

Free-cut

<with FX-AT4>

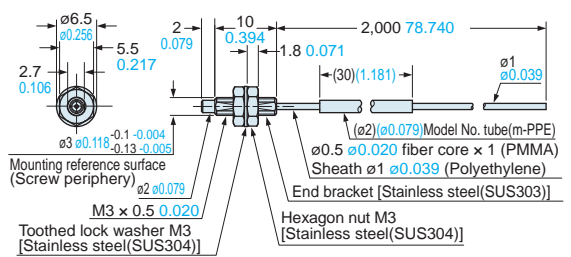

FT-40

<with FX-AT2>

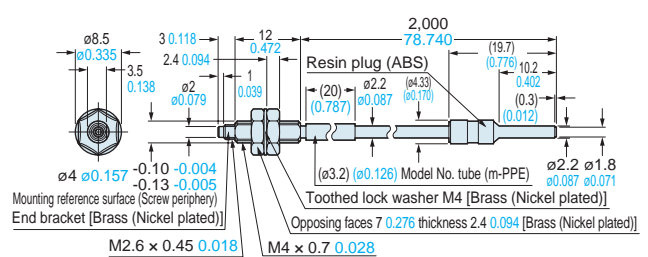

FT-42

Free-cut

<with FX-AT3>

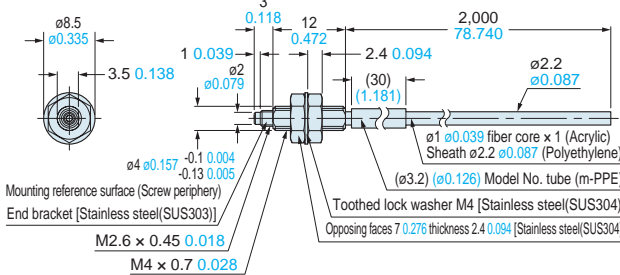

FT-42S

Free-cut

<with FX-AT3>

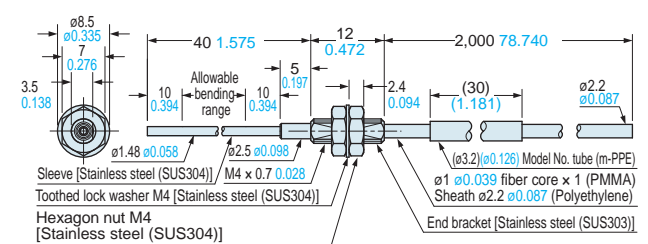

FT-42W

Free-cut

<with FX-AT3>

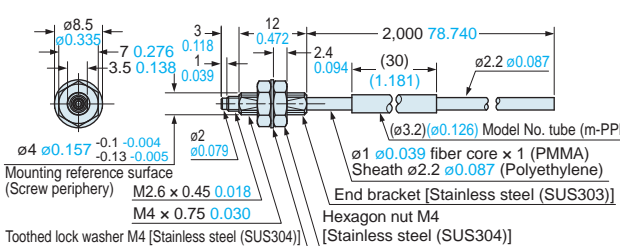

FT-43

Free-cut

<with FX-AT3>

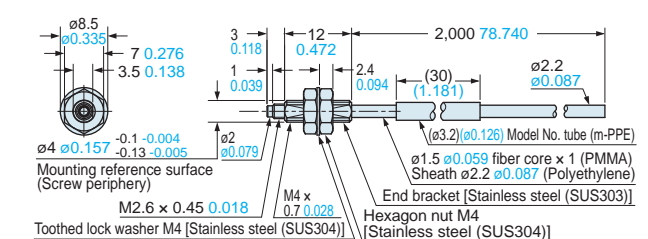

New product introduction
Tough Fiber
Fiber Selection Guide
Model
Choose by shape/application
How to read Model No
Earlier models comparison table

Fibers
Super Quality
Threaded Type
Square Head Type
Cylindrical Type
Sleeve
Flat Type
Small Spot
Narrow Beam
Wide Beam
Convergent Reflective Type
Retroreflective Type
Chemical / Oil-resistant
Heat-resistant
Vacuum-resistant
Liquid Leak / Liquid Detection

Fiber Options
Semi-custom fibers
Fiber Dimensions
Thru-beam Type
Retroreflective Type
Reflective Type
Others

Amplifiers
FX-500 series
FX-100 series

INDEX

DIMENSIONS (Unit: mm in)

Refer to the **FX-500 series** (p.96), **FX-100 series** (p.110) for dimensions of the amplifiers. The CAD data in the dimensions can be downloaded from our website.

Thru-beam type fibers

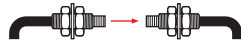

Dimensions are listed in the order of thru-beam type, retroreflective type, and reflective type, and in alphabetic order of the Model No.

FT-45X

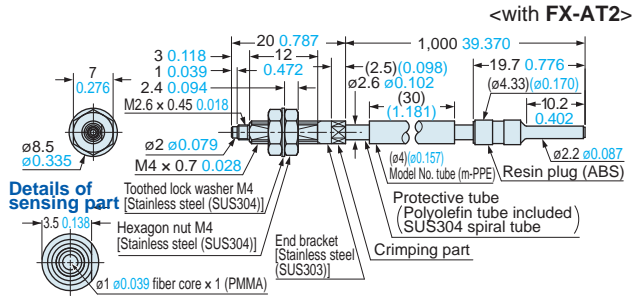

FT-A11W

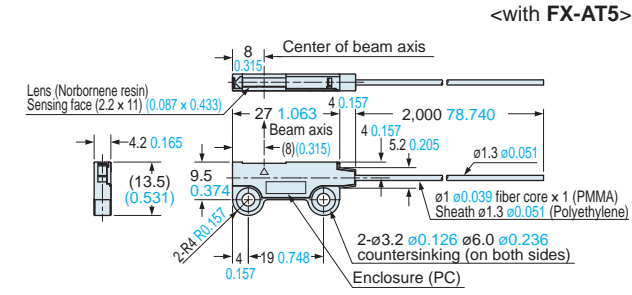

FT-A32W

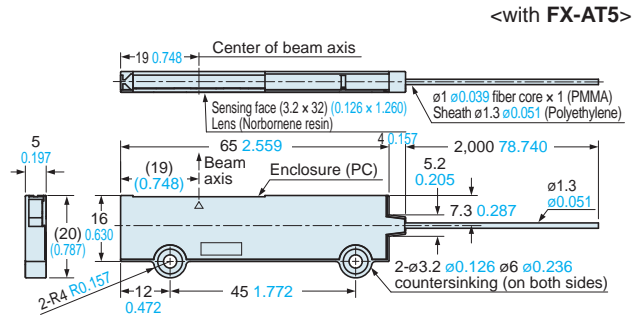

FT-E13

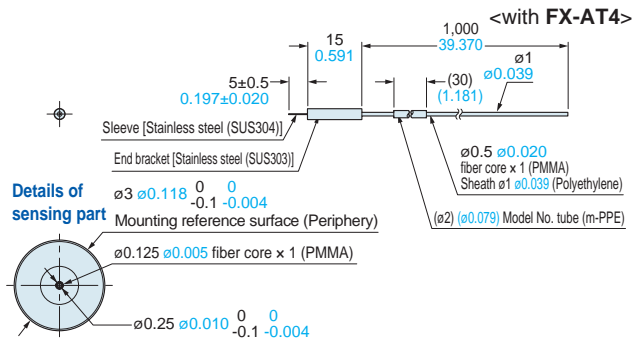

FT-F93

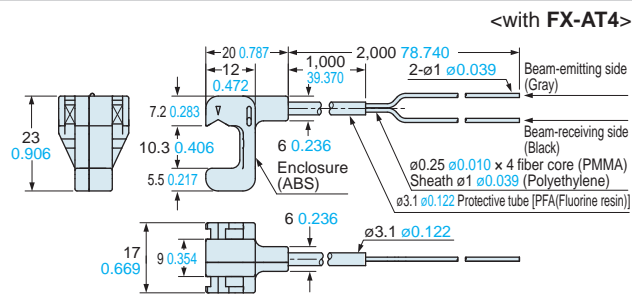

FT-A11

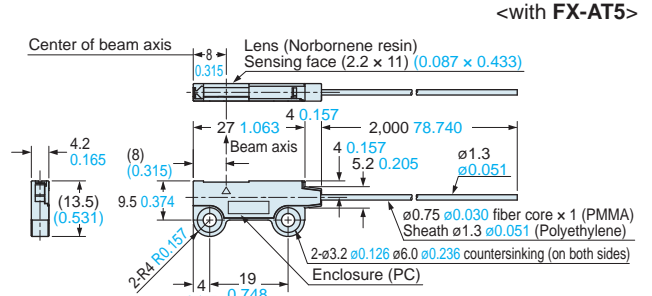

FT-A32

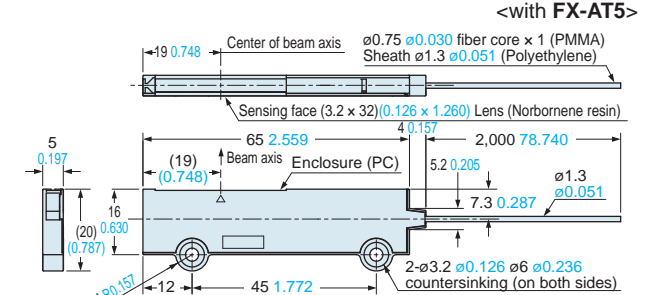

FT-AL05

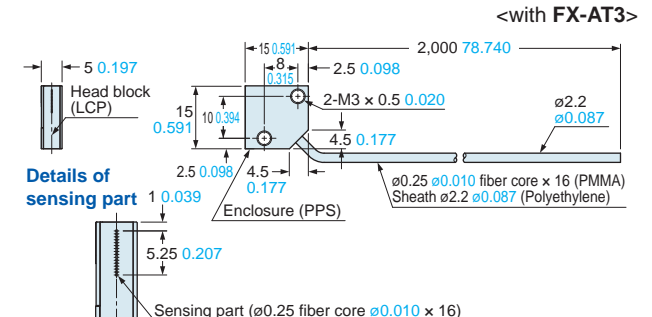

FT-E23

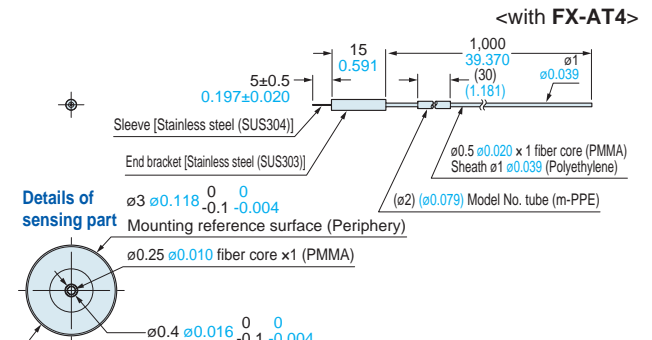

FT-H13-FM2

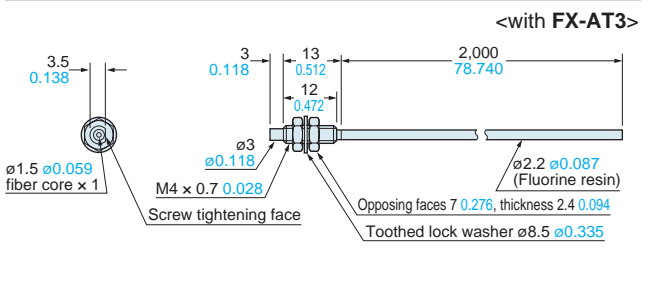

New product introduction
Tough Fiber

Fiber Selection Guide
Model
Choose by shape/application
How to read Model No.
Earlier models comparison table

Fibers
Super Quality
Threaded Type
Square Head Type
Cylindrical Type
Sleeve
Flat Type
Small Spot
Narrow Beam
Wide Beam
Convergent Reflective Type
Retroreflective Type
Chemical / Oil-resistant
Heat-resistant
Vacuum-resistant
Liquid Leak / Liquid Detection

Fiber Options

Semi-custom fibers

Fiber Dimensions
Thru-beam Type
Retroreflective Type
Reflective Type
Others

Amplifiers
FX-500 series
FX-100 series

INDEX

DIMENSIONS (Unit: mm in)

Refer to the **FX-500** series (p.96), **FX-100** series (p.110) for dimensions of the amplifiers. The CAD data in the dimensions can be downloaded from our website.

Thru-beam type fibers



Dimensions are listed in the order of thru-beam type, retroreflective type, and reflective type, and in alphabetic order of the Model No.

FT-H20-J20-S FT-H20-J30-S FT-H20-J50-S Free-cut (Note)

Heat-resistant side unit diagram (side view)

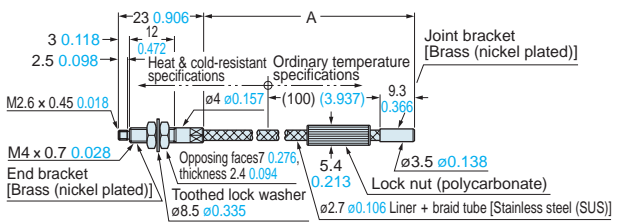

Ordinary temperature side fiber (FT-42) connection diagram (front view)

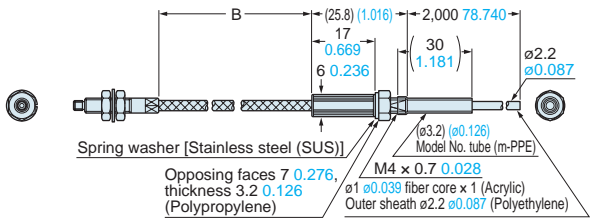

Model No.	A	B
FT-H20-J20-S	200 ⁺²⁵ ₀ 7.874 ^{+0.984} ₀	185 ⁺³⁰ ₀ 7.284 ^{+1.181} ₀
FT-H20-J30-S	300 ⁺²⁵ ₀ 11.811 ^{+0.984} ₀	285 ⁺³⁰ ₀ 11.221 ^{+1.181} ₀
FT-H20-J50-S	500 ⁺²⁵ ₀ 19.685 ^{+0.984} ₀	485 ⁺³⁰ ₀ 19.095 ^{+1.181} ₀

Note: Ordinary temperature side fiber (FT-42) only.

FT-H20-VJ50-S FT-H20-VJ80-S Free-cut (Note)

Heat-resistant side unit diagram (side view)

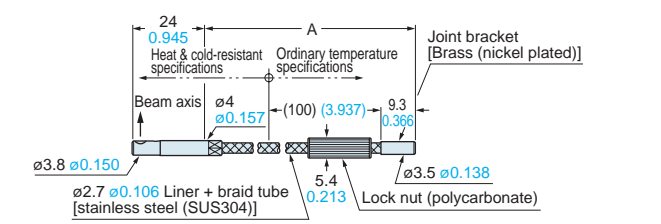

Ordinary temperature side fiber (FT-42) connection diagram (front view)

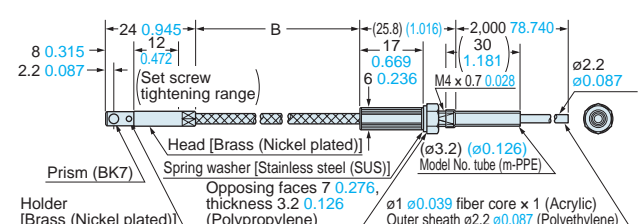

Model No.	A	B
FT-H20-VJ50-S	500 ⁺²⁵ ₀ 19.685 ^{+0.984} ₀	485 ⁺³⁰ ₀ 19.095 ^{+1.181} ₀
FT-H20-VJ80-S	800 ⁺⁵⁰ ₀ 31.496 ^{+1.969} ₀	785 ⁺⁵⁵ ₀ 30.906 ^{+2.165} ₀

Note: Ordinary temperature side fiber (FT-42) only.

FT-H20-M1

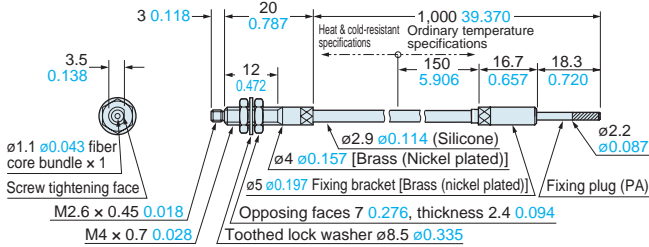

FT-H20W-M1

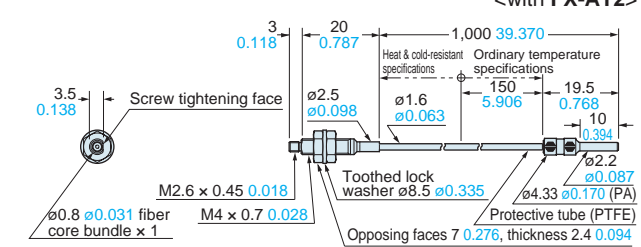

FT-H30-M1V-S

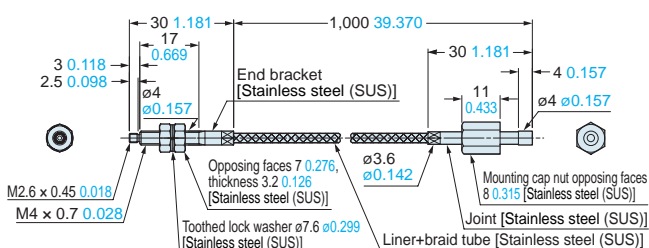

Note: The FT-H30-M1V-S is a set with the FT-H30-M1V, photo-terminal, and atmospheric side fiber. Refer to p.66 for dimensions of the atmospheric side fiber and photo-terminals.

FT-H35-M2

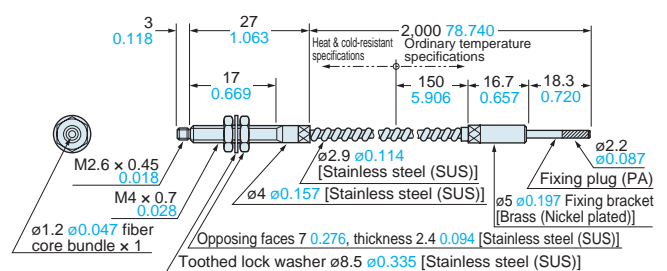

FT-H35-M2S6

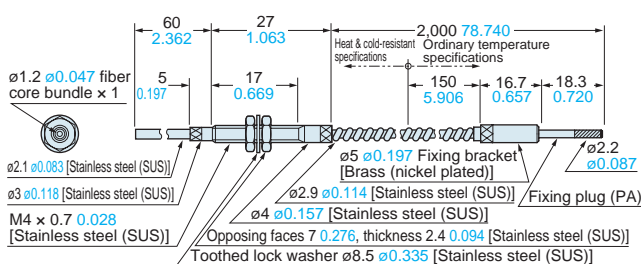

FT-HL80Y Free-cut

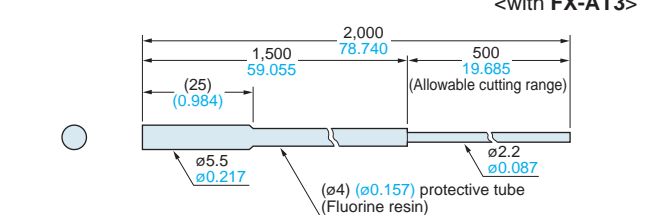

New product introduction
Tough Fiber
Fiber Selection Guide
Model
Choose by shape/application
How to read Model No
Earlier models comparison table

Fibers
Super Quality
Threaded Type
Square Head Type
Cylindrical Type
Sleeve
Flat Type
Small Spot
Narrow Beam
Wide Beam
Convergent Reflective Type
Retroreflective Type
Chemical / Oil-resistant
Heat-resistant
Vacuum-resistant
Liquid Leak / Liquid Detection

Fiber Options
Semi-custom fibers
Fiber Dimensions
Thru-beam Type
Retroreflective Type
Reflective Type
Others

Amplifiers
FX-500 series
FX-100 series
INDEX

DIMENSIONS (Unit: mm in) Refer to the **FX-500 series (p.96)**, **FX-100 series (p.110)** for dimensions of the amplifiers. The CAD data in the dimensions can be downloaded from our website.

Thru-beam type fibers

Dimensions are listed in the order of thru-beam type, retroreflective type, and reflective type, and in alphabetic order of the Model No.

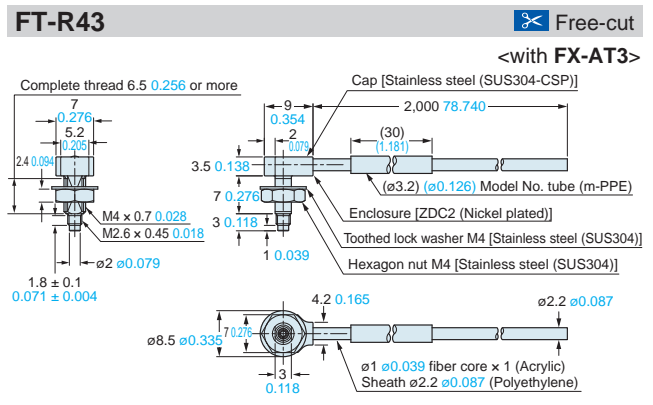
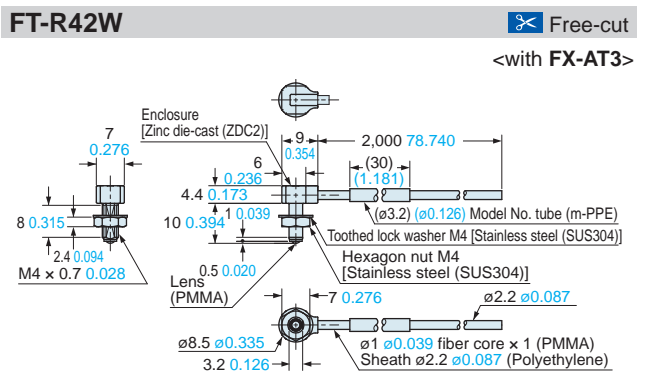
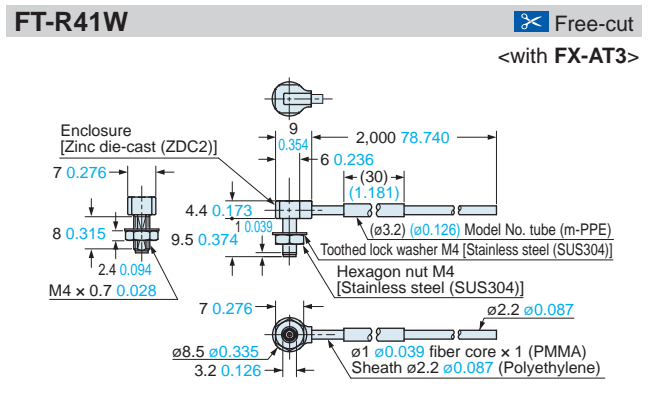
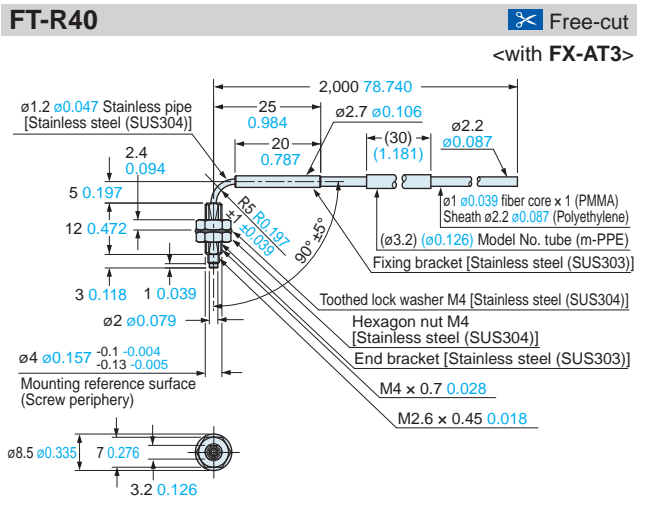
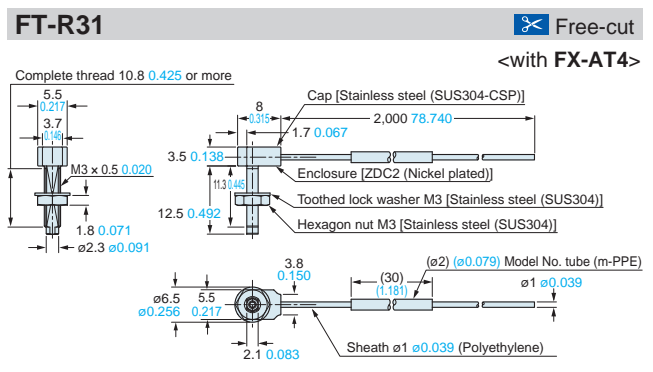
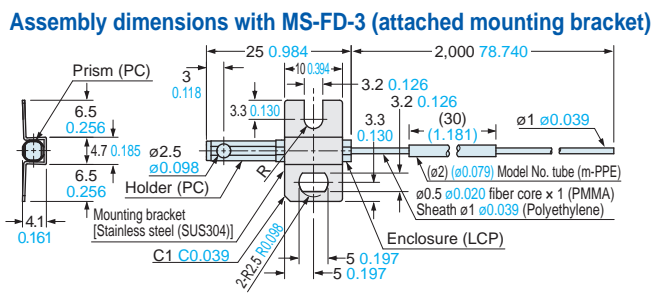
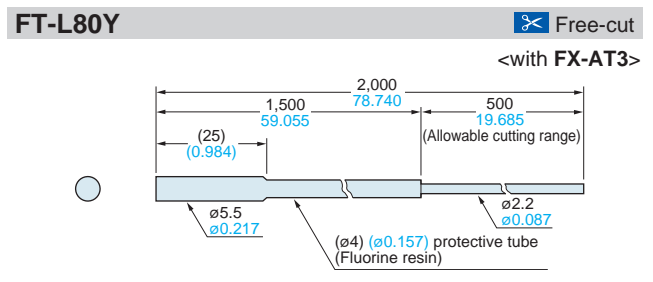
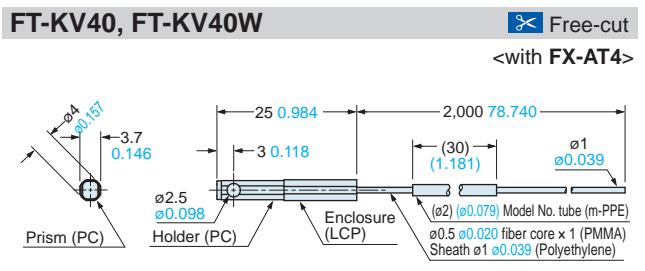
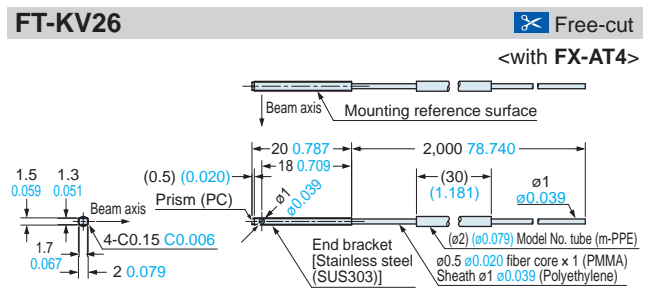
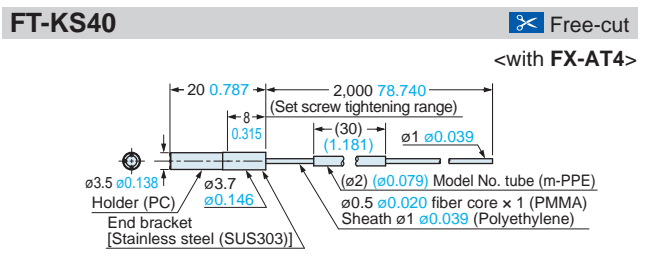

New product introduction
 Tough Fiber

Fiber Selection Guide
 Model
 Choose by shape/application
 How to read Model No.
 Earlier models comparison table

Fibers
 Super Quality
 Threaded Type
 Square Head Type
 Cylindrical Type
 Sleeve
 Flat Type
 Small Spot
 Narrow Beam
 Wide Beam
 Convergent Reflective Type
 Retroreflective Type
 Chemical / Oil-resistant
 Heat-resistant
 Vacuum-resistant
 Liquid Leak / Liquid Detection

Fiber Options

Semi-custom fibers

Fiber Dimensions
 Thru-beam Type
 Retroreflective Type
 Reflective Type
 Others

Amplifiers
 FX-500 series
 FX-100 series

INDEX

DIMENSIONS (Unit: mm in)

Refer to the FX-500 series (p.96), FX-100 series (p.110) for dimensions of the amplifiers. The CAD data in the dimensions can be downloaded from our website.

Thru-beam type fibers



Dimensions are listed in the order of thru-beam type, retroreflective type, and reflective type, and in alphabetic order of the Model No.

FT-R44Y Free-cut

<with FX-AT3>

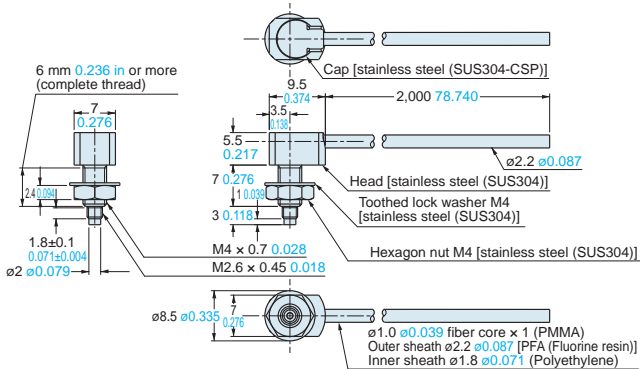

FT-R60Y Free-cut

<with FX-AT3>

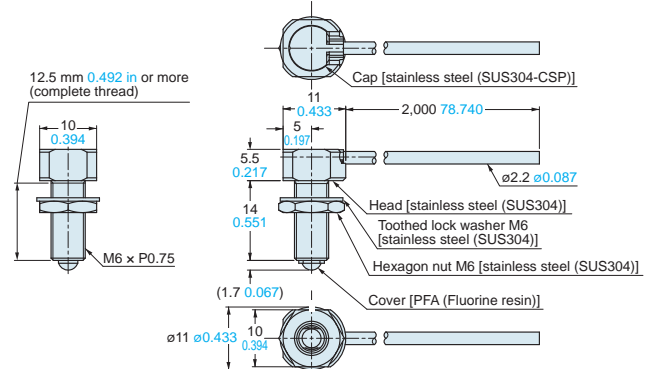

FT-S11 Free-cut

<with FX-AT2>

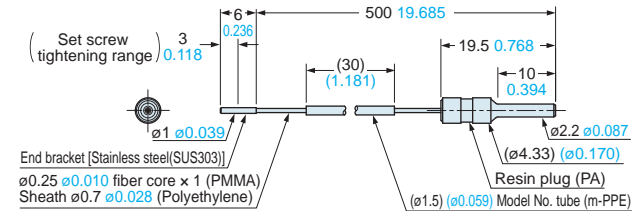

FT-S20 Free-cut

<with FX-AT2>

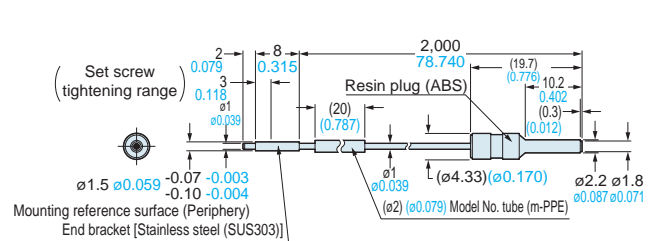

FT-S21 Free-cut

<with FX-AT4>

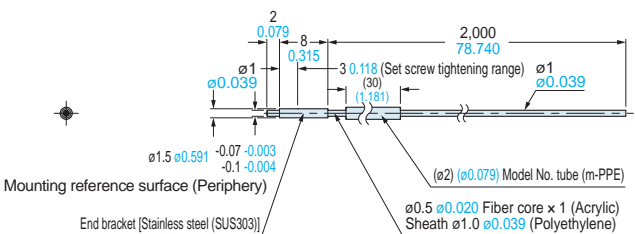

FT-S21W Free-cut

<with FX-AT4>

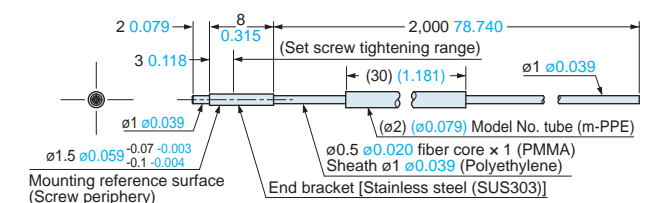

FT-S30 Free-cut

<with FX-AT2>

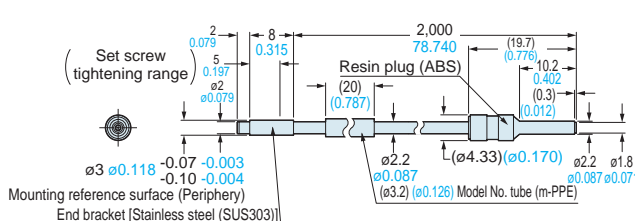

FT-S31W Free-cut

<with FX-AT3>

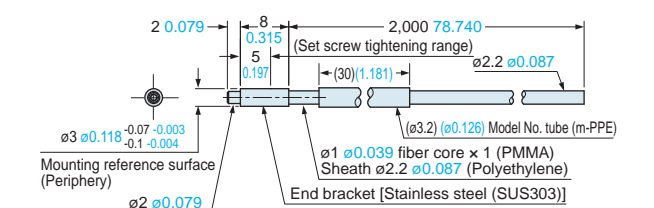

FT-S32 Free-cut

<with FX-AT3>

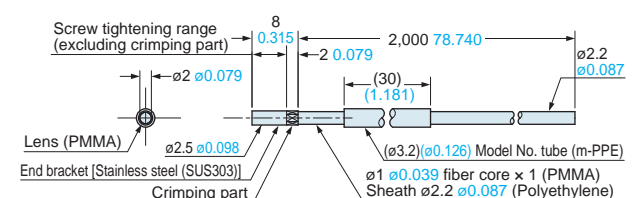

FT-V23 Free-cut

<with FX-AT5>

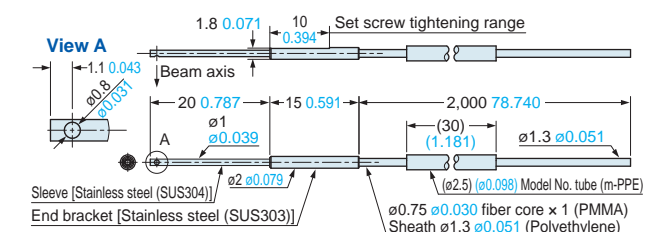

DIMENSIONS (Unit: mm in) Refer to the **FX-500 series** (p.96), **FX-100 series** (p.110) for dimensions of the amplifiers. The CAD data in the dimensions can be downloaded from our website.

Thru-beam type fibers 

Dimensions are listed in the order of thru-beam type, retroreflective type, and reflective type, and in alphabetic order of the Model No.

FT-V24W  Free-cut
 <with FX-AT4>

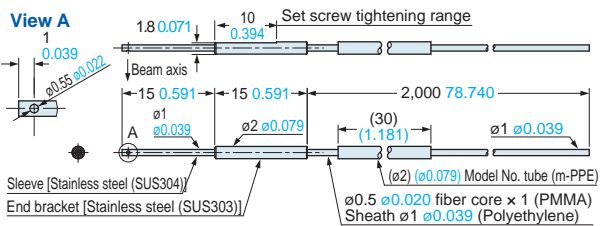

FT-V25  Free-cut
 <with FX-AT4>

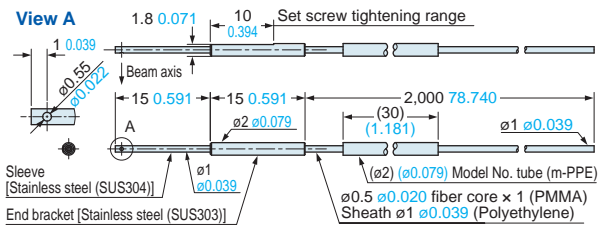

FT-V30  Free-cut
 <with FX-AT3>

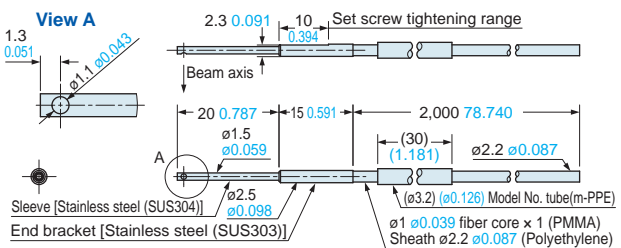

FT-V40  Free-cut
 <with FX-AT3>

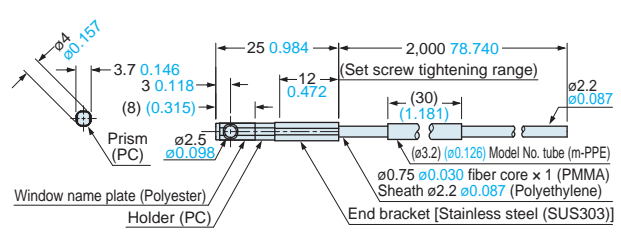

FT-V80Y  Free-cut
 <with FX-AT3>

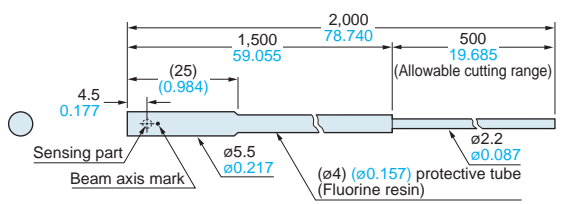

FT-Z20HBW  Free-cut
 <with FX-AT4>

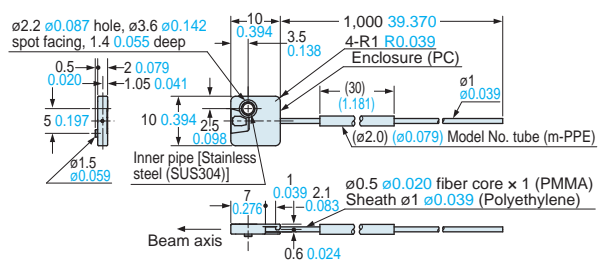

FT-Z20W  Free-cut
 <with FX-AT4>

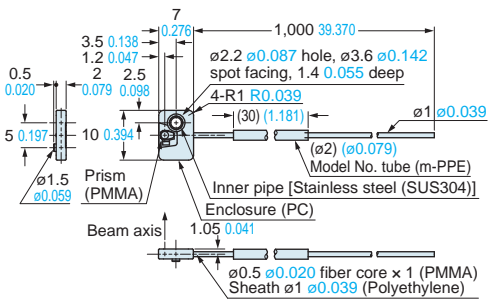

FT-Z30  Free-cut
 <with FX-AT5>

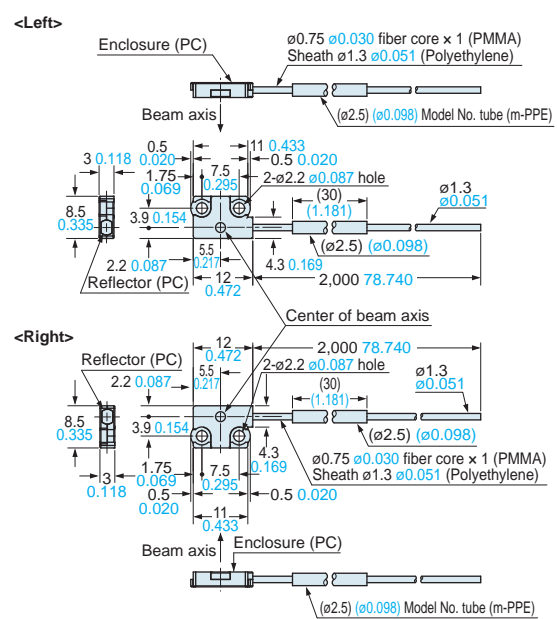

FT-Z30E  Free-cut
 <with FX-AT5>

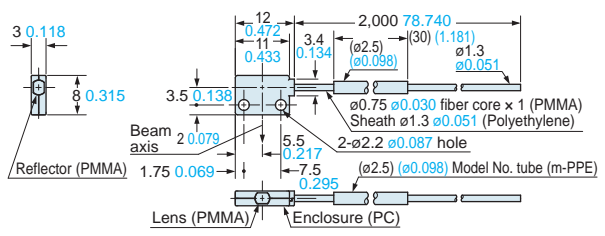

New product introduction
Tough Fiber

Fiber Selection Guide
Model
Choose by shape/application
How to read Model No.
Earlier models comparison table

Fibers
Super Quality
Threaded Type
Square Head Type
Cylindrical Type
Sleeve
Flat Type
Small Spot
Narrow Beam
Wide Beam
Convergent Reflective Type
Retroreflective Type
Chemical / Oil-resistant
Heat-resistant
Vacuum-resistant
Liquid Leak / Liquid Detection

Fiber Options

Semi-custom fibers

Fiber Dimensions
Thru-beam Type
Retroreflective Type
Reflective Type
Others

Amplifiers
FX-500 series
FX-100 series

INDEX

New product introduction
Tough Fiber

Fiber Selection Guide

Model
Choose by shape/application
How to read Model No
Earlier models comparison table

Fibers

Super Quality
Threaded Type
Square Head Type
Cylindrical Type
Sleeve
Flat Type
Small Spot
Narrow Beam
Wide Beam
Convergent Reflective Type
Retroreflective Type
Chemical / Oil-resistant
Heat-resistant
Vacuum-resistant
Liquid Leak / Liquid Detection

Fiber Options

Semi-custom fibers

Fiber Dimensions
Thru-beam Type

Retroreflective Type
Reflective Type

Others

Amplifiers

FX-500 series
FX-100 series

INDEX

DIMENSIONS (Unit: mm in)

Refer to the FX-500 series (p.96), FX-100 series (p.110) for dimensions of the amplifiers. The CAD data in the dimensions can be downloaded from our website.

Thru-beam type fibers



Dimensions are listed in the order of thru-beam type, retroreflective type, and reflective type, and in alphabetic order of the Model No.

FT-Z30EW

Free-cut

<with FX-AT5>

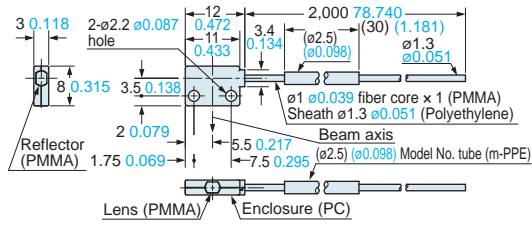

FT-Z30H

Free-cut

<with FX-AT5>

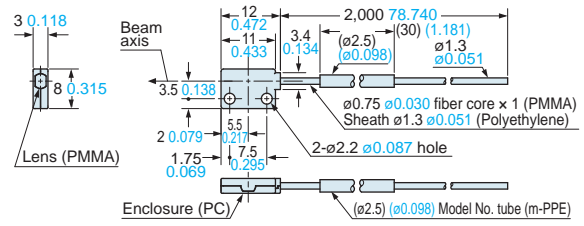

FT-Z30HW

Free-cut

<with FX-AT5>

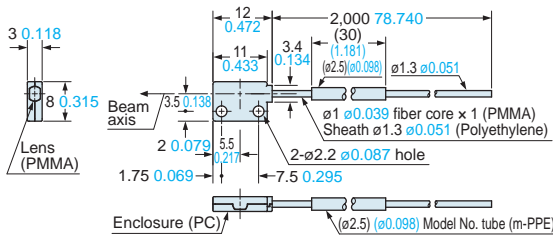

FT-Z30W

Free-cut

<with FX-AT5>

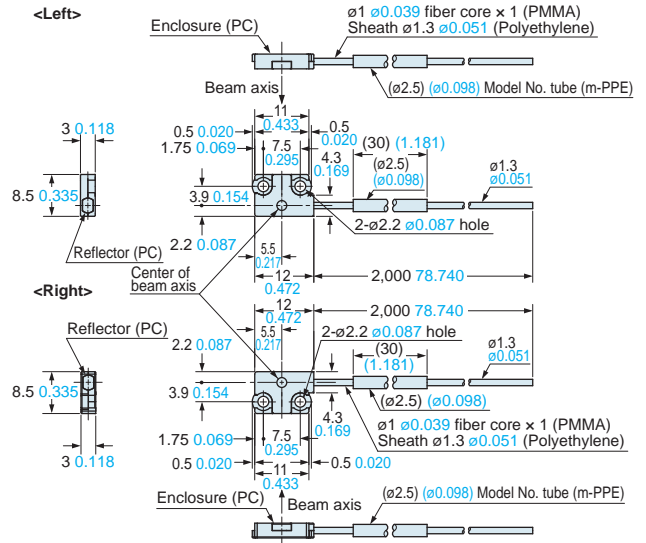

FT-Z40HBW

Free-cut

<with FX-AT5>

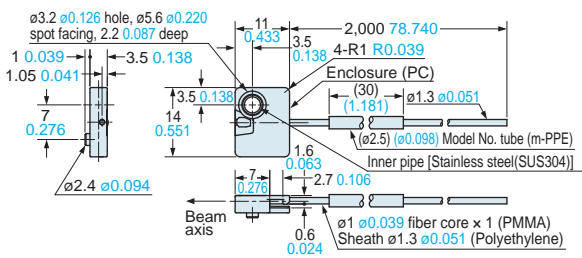

FT-Z40W

Free-cut

<with FX-AT5>

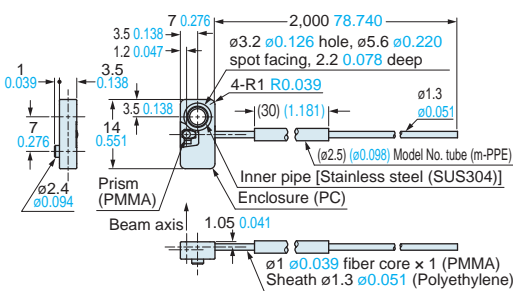

FT-Z802Y

Free-cut

<with FX-AT3>

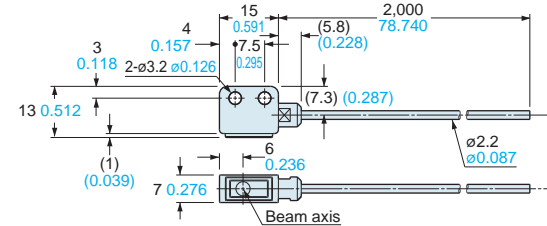

DIMENSIONS (Unit: mm in)

Refer to the **FX-500 series** (p.96), **FX-100 series** (p.110) for dimensions of the amplifiers.
The CAD data in the dimensions can be downloaded from our website.

Retroreflective type fibers

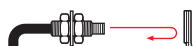

Dimensions are listed in the order of thru-beam type, retroreflective type, and reflective type, and in alphabetic order of the Model No.

FR-KZ22E

Free-cut

<with FX-AT4>

Reflector

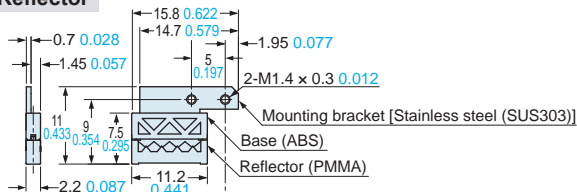

Fiber

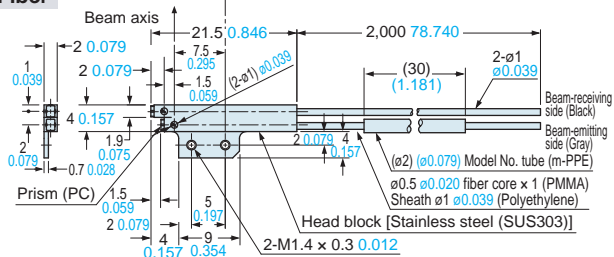

FR-KZ50H

Free-cut

<with FX-AT4>

Fiber

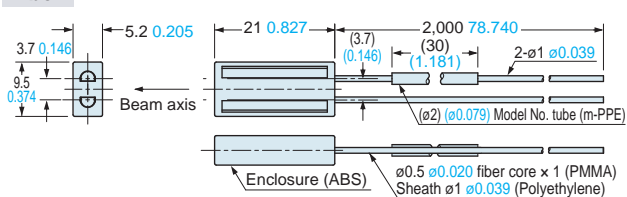

Assembly dimensions with MS-FD-2 (attached mounting bracket)

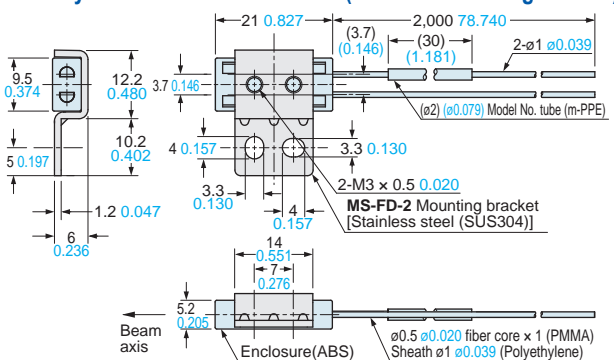

Reflector RF-003 (Accessory for FR-KZ50H)

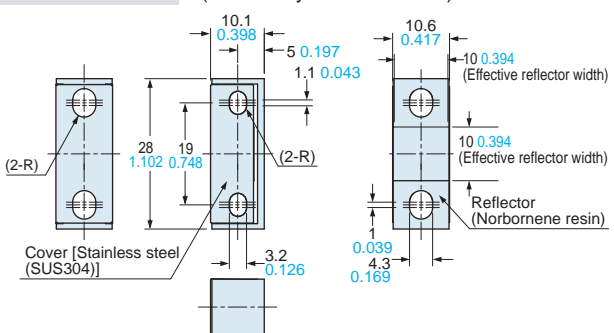

FR-KZ50E

Free-cut

<with FX-AT4>

Fiber

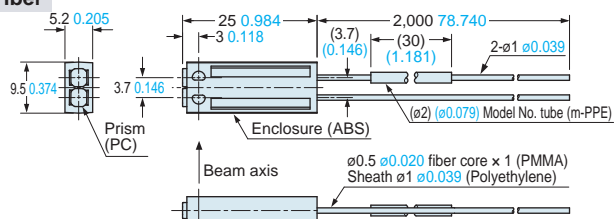

Assembly dimensions with MS-FD-2 (attached mounting bracket)

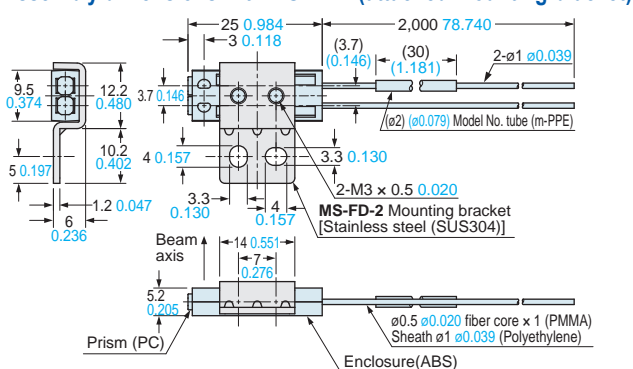

Reflector RF-003 (Accessory for FR-KZ50E)

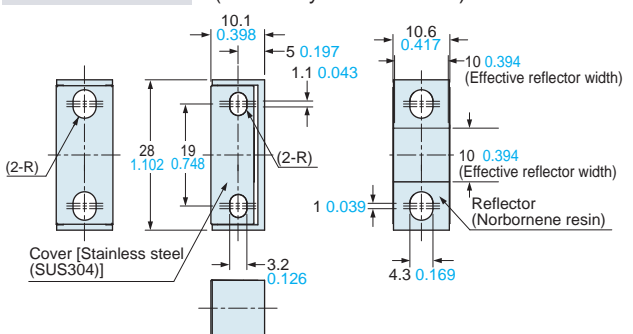

FR-Z50HW

Free-cut

<with FX-AT3>

Fiber

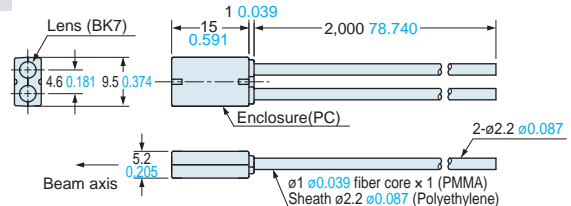

Assembly dimensions with MS-FD-2 (attached mounting bracket)

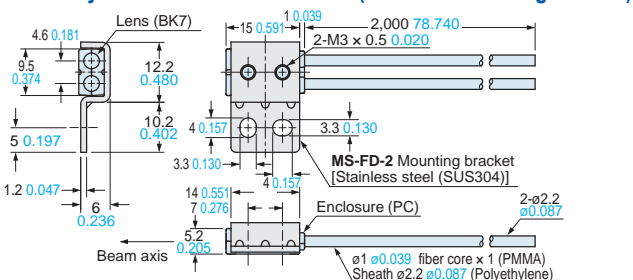

Reflective tape RF-13 (Accessory for FR-Z50HW)

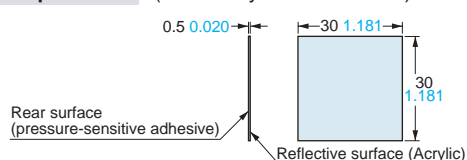

New product introduction

Tough Fiber

Fiber Selection Guide

Model

Choose by shape/application

How to read Model No.

Earlier models comparison table

Fibers

Super Quality

Threaded Type

Square Head Type

Cylindrical Type

Sleeve

Flat Type

Small Spot

Narrow Beam

Wide Beam

Convergent Reflective Type

Retroreflective Type

Chemical / Oil-resistant

Heat-resistant

Vacuum-resistant

Liquid Leak / Liquid Detection

Fiber Options

Semi-custom fibers

Fiber Dimensions

Thru-beam Type

Retroreflective Type

Reflective Type

Others

Amplifiers

FX-500 series

FX-100 series

INDEX

DIMENSIONS (Unit: mm in)

Refer to the **FX-500 series** (p.96), **FX-100 series** (p.110) for dimensions of the amplifiers. The CAD data in the dimensions can be downloaded from our website.

Reflective type fibers



Dimensions are listed in the order of thru-beam type, retroreflective type, and reflective type, and in alphabetic order of the Model No.

FD-30

<with FX-AT2>

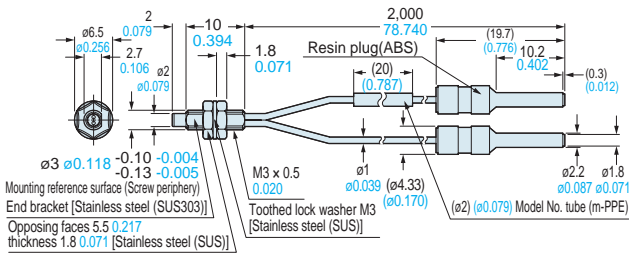

FD-31

Free-cut

<with FX-AT4>

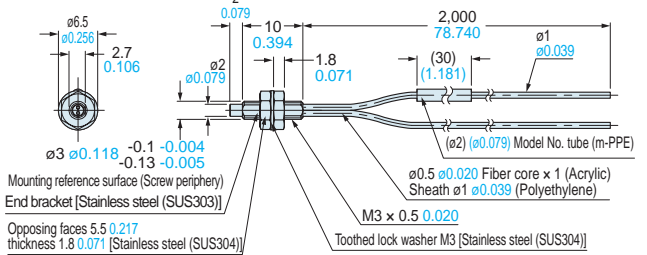

FD-31W

Free-cut

<with FX-AT4>

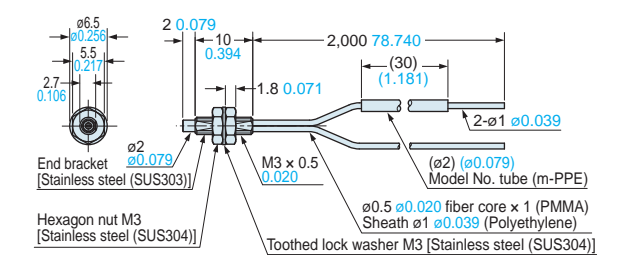

FD-32G

Free-cut

<with FX-AT6>

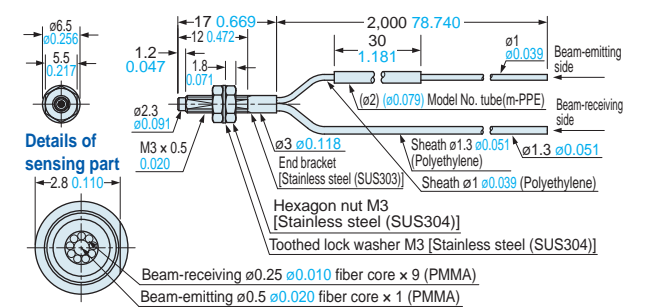

FD-32GX

Free-cut

<with FX-AT6>

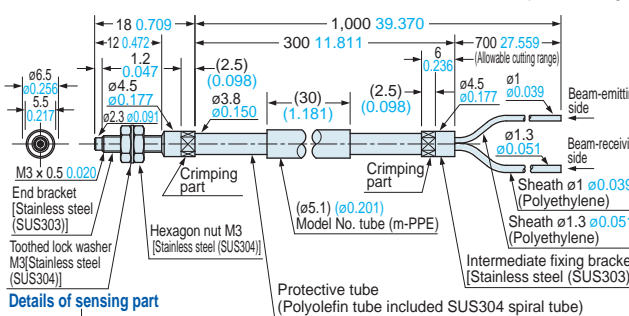

FD-40

<with FX-AT2>

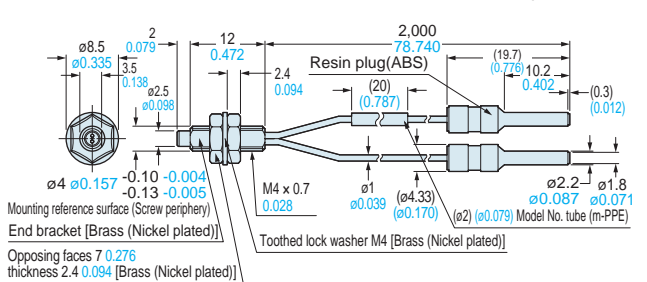

FD-41

Free-cut

<with FX-AT4>

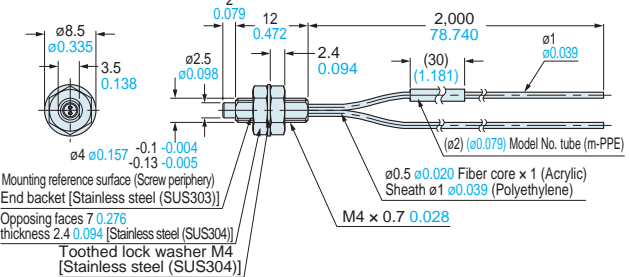

FD-41S

Free-cut

<with FX-AT4>

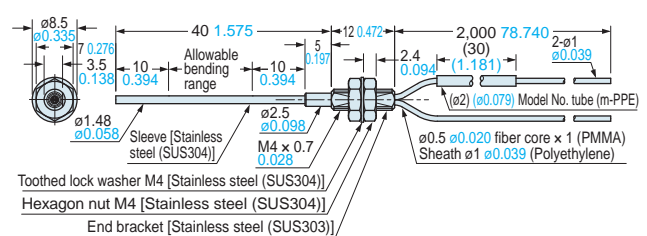

FD-41SW

Free-cut

<with FX-AT4>

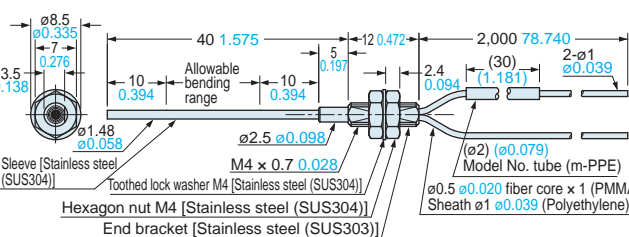

FD-41W

Free-cut

<with FX-AT5>

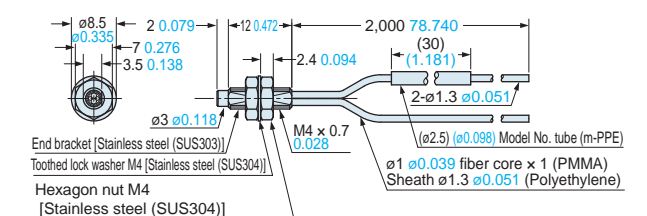

New product introduction
Tough Fiber
Fiber Selection Guide
Model
Choose by shape/application
How to read Model No
Earlier models comparison table

Fibers
Super Quality
Threaded Type
Square Head Type
Cylindrical Type
Sleeve
Flat Type
Small Spot
Narrow Beam
Wide Beam
Convergent Reflective Type
Retroreflective Type
Chemical / Oil-resistant
Heat-resistant
Vacuum-resistant
Liquid Leak / Liquid Detection

Fiber Options
Semi-custom fibers

Fiber Dimensions
Thru-beam Type
Retroreflective Type
Reflective Type
Others

Amplifiers
FX-500 series
FX-100 series

INDEX

DIMENSIONS (Unit: mm in) Refer to the **FX-500 series** (p.96), **FX-100 series** (p.110) for dimensions of the amplifiers. The CAD data in the dimensions can be downloaded from our website.

Reflective type fibers 

Dimensions are listed in the order of thru-beam type, retroreflective type, and reflective type, and in alphabetic order of the Model No.

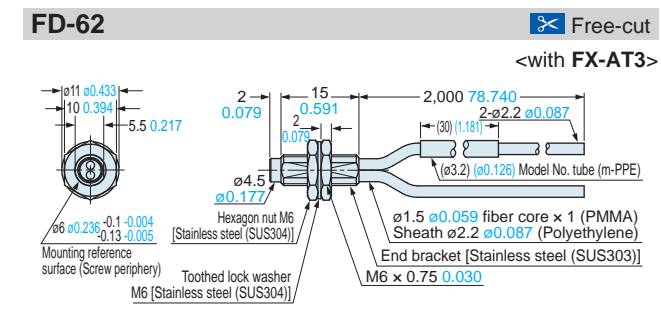
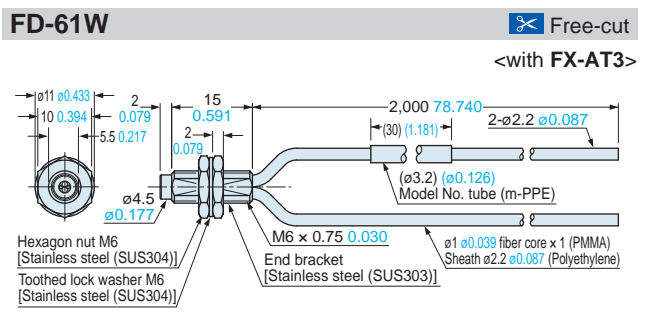
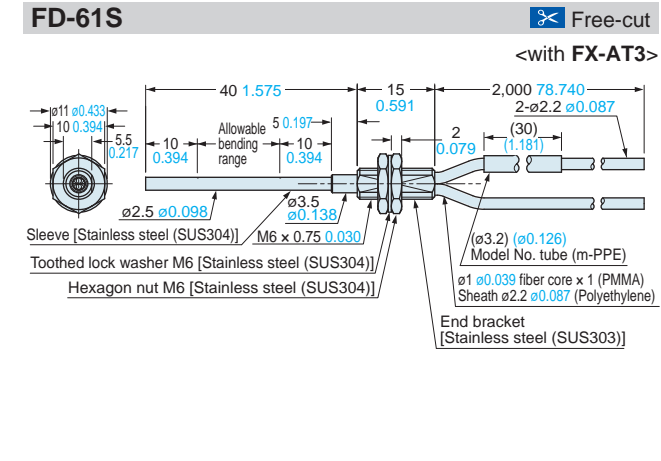
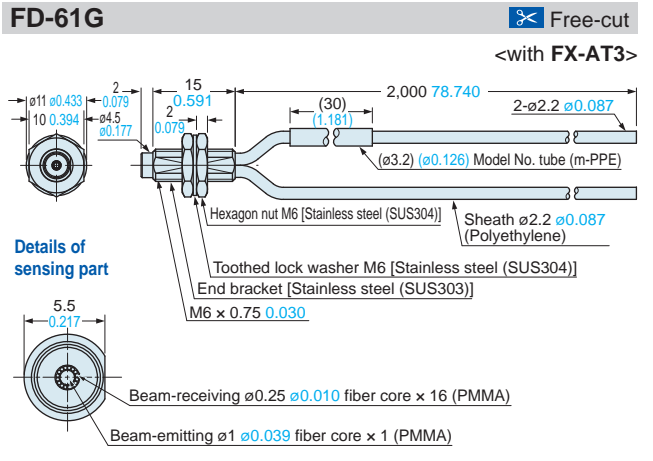
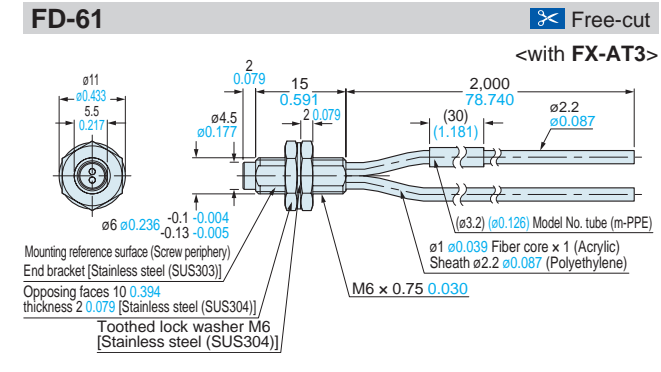
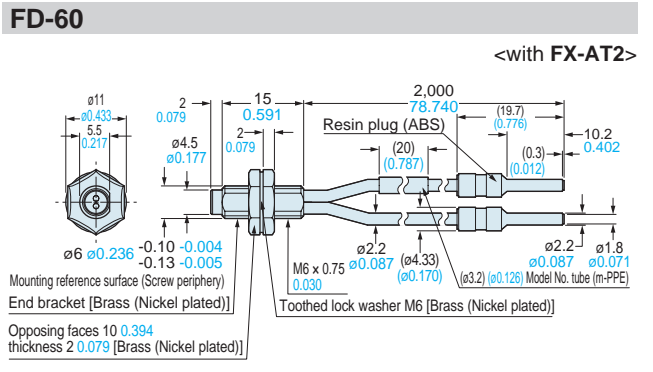
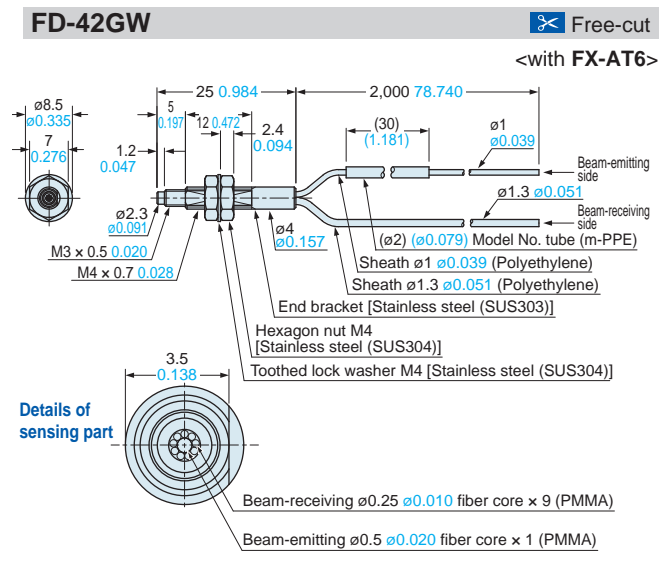
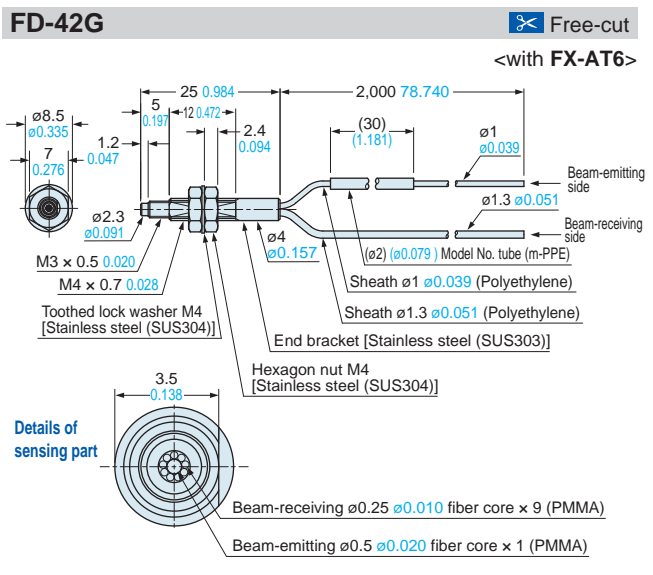

New product introduction
 Tough Fiber
 Fiber Selection Guide
 Model
 Choose by shape/application
 How to read Model No.
 Earlier models comparison table

Fibers
 Super Quality
 Threaded Type
 Square Head Type
 Cylindrical Type
 Sleeve
 Flat Type
 Small Spot
 Narrow Beam
 Wide Beam
 Convergent Reflective Type
 Retroreflective Type
 Chemical / Oil-resistant
 Heat-resistant
 Vacuum-resistant
 Liquid Leak / Liquid Detection

Fiber Options
 Semi-custom fibers
 Fiber Dimensions
 Thru-beam Type
 Retroreflective Type
 Reflective Type
 Others

Amplifiers
 FX-500 series
 FX-100 series

INDEX

DIMENSIONS (Unit: mm in)

Refer to the FX-500 series (p.96), FX-100 series (p.110) for dimensions of the amplifiers. The CAD data in the dimensions can be downloaded from our website.

Reflective type fibers



Dimensions are listed in the order of thru-beam type, retroreflective type, and reflective type, and in alphabetic order of the Model No.

FD-64X

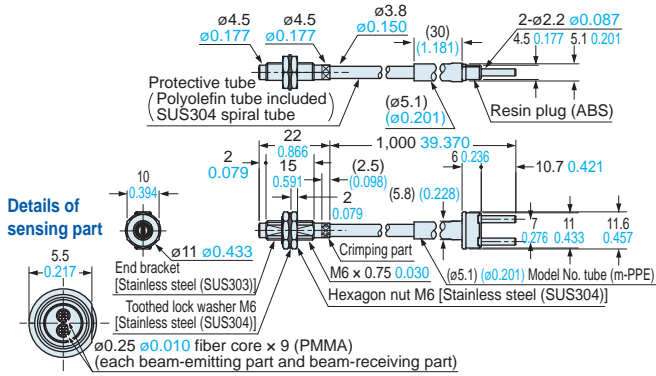

FD-A16

Free-cut

<with FX-AT3>

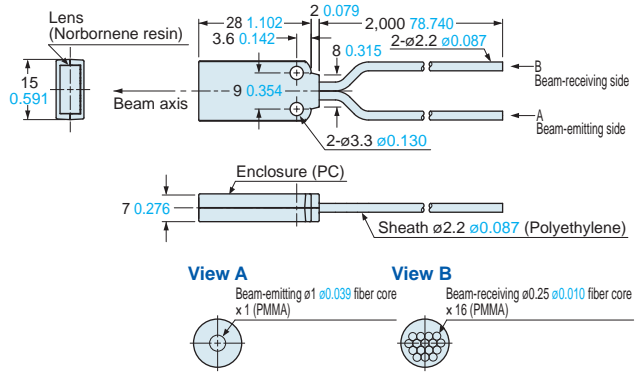

FD-AL11

Free-cut

<with FX-AT3>

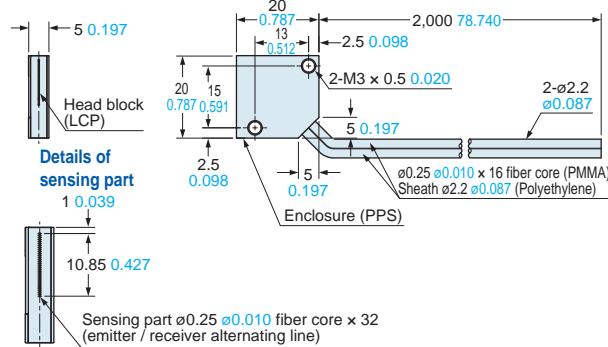

FD-E13

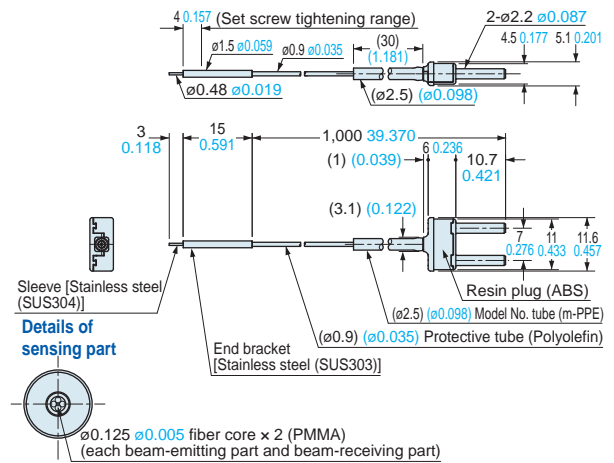

FD-E23

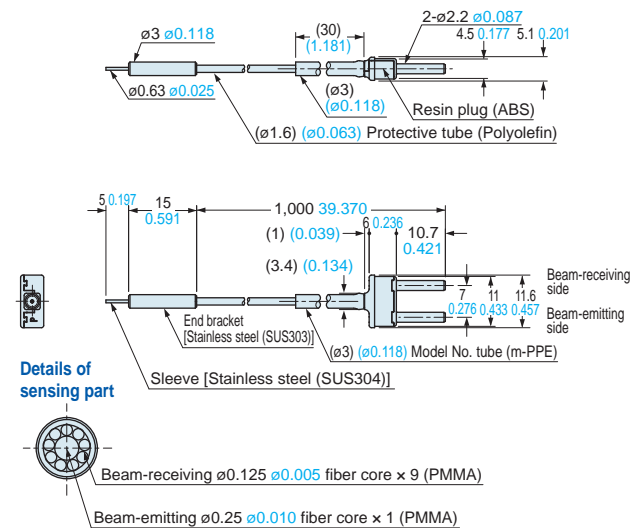

FD-EG30

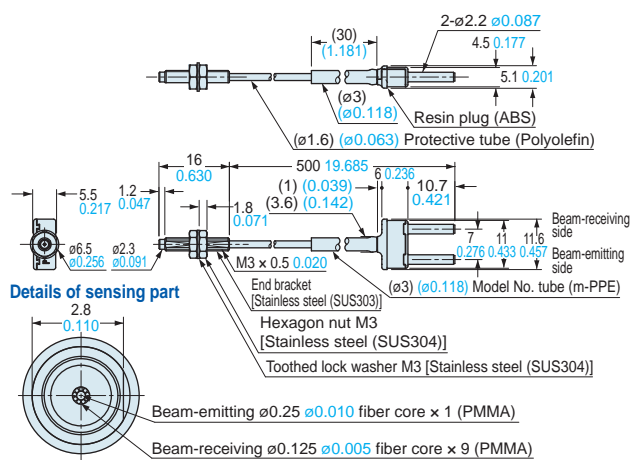

DIMENSIONS (Unit: mm in) Refer to the **FX-500 series** (p.96), **FX-100 series** (p.110) for dimensions of the amplifiers. The CAD data in the dimensions can be downloaded from our website.

Reflective type fibers 

Dimensions are listed in the order of thru-beam type, retroreflective type, and reflective type, and in alphabetic order of the Model No.

FD-EG30S

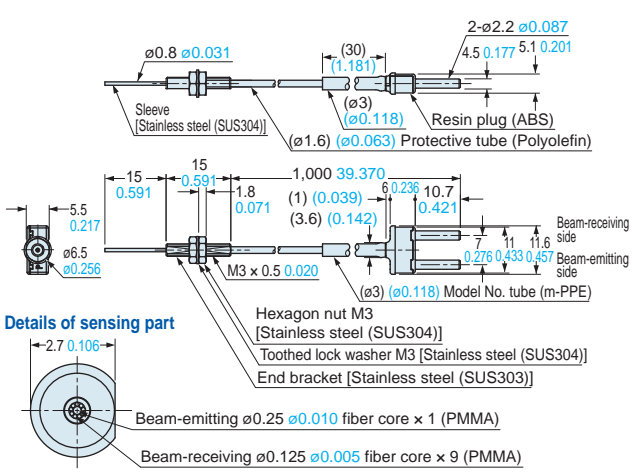

FD-EG31

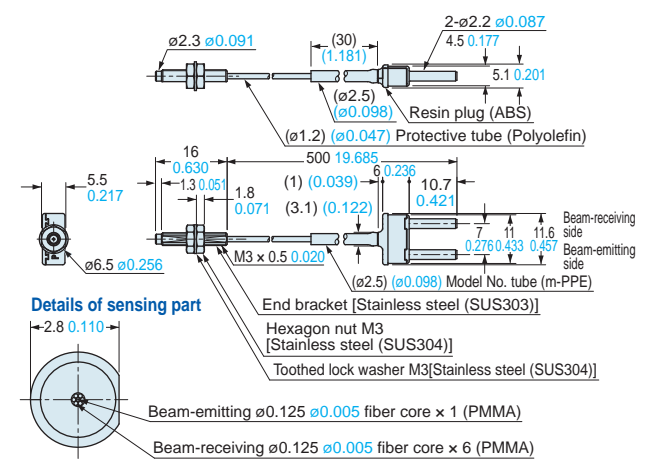

FD-F4, FD-F41  Free-cut

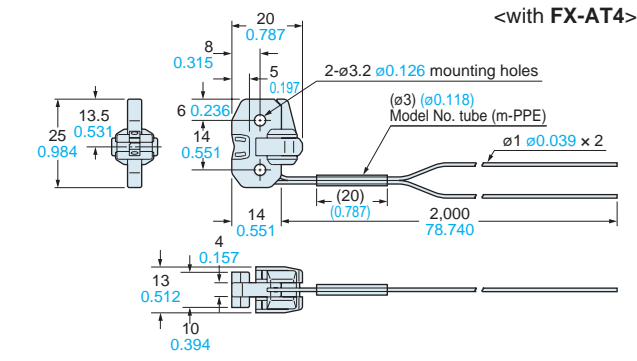

FD-F41Y  Free-cut

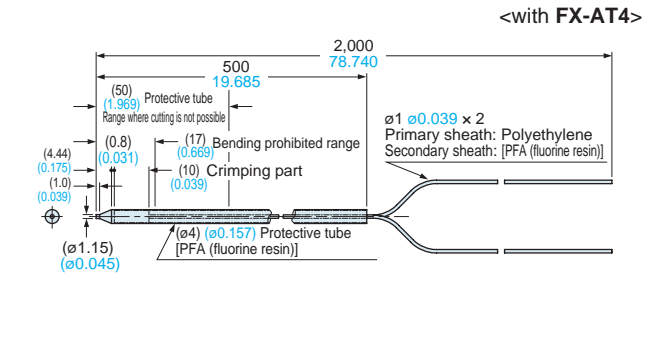

FD-F71  Free-cut

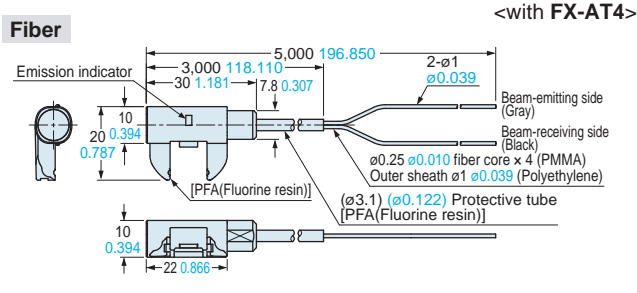

FD-F8Y  Free-cut

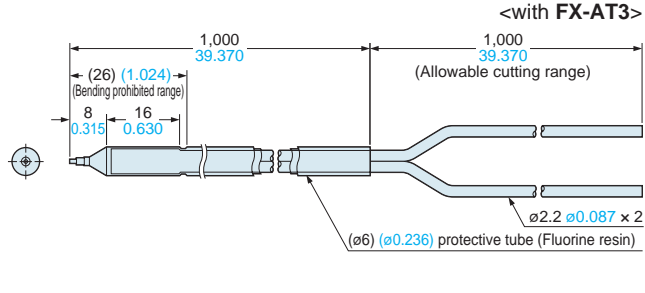

SUS mounting bracket

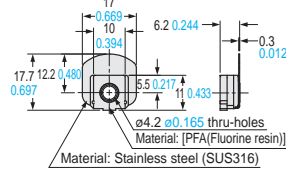

SUS mounting bracket (FD-71) mounting diagram

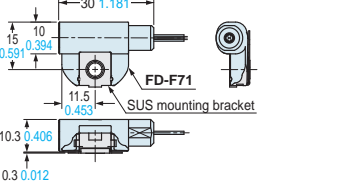

PVC mounting bracket

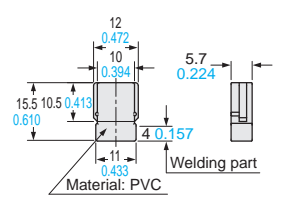

PVC mounting bracket (FD-71) mounting diagram

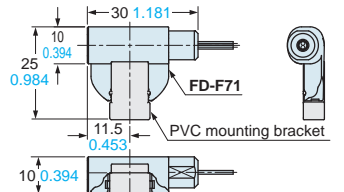

FD-FA93  Free-cut

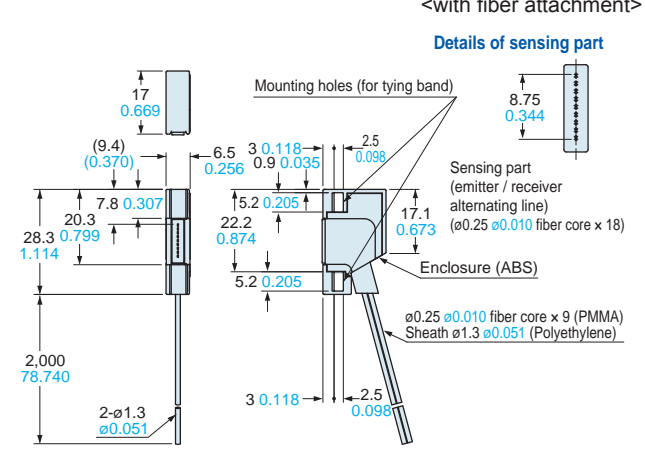

New product introduction

Tough Fiber

Fiber Selection Guide

Model

Choose by shape/application

How to read Model No.

Earlier models comparison table

Fibers

Super Quality

Threaded Type

Square Head Type

Cylindrical Type

Sleeve

Flat Type

Small Spot

Narrow Beam

Wide Beam

Convergent Reflective Type

Retroreflective Type

Chemical / Oil-resistant

Heat-resistant

Vacuum-resistant

Liquid Leak / Liquid Detection

Fiber Options

Semi-custom fibers

Fiber Dimensions

Thru-beam Type

Retroreflective Type

Reflective Type

Others

Amplifiers

FX-500 series

FX-100 series

INDEX

DIMENSIONS (Unit: mm in)

Refer to the **FX-500 series** (p.96), **FX-100 series** (p.110) for dimensions of the amplifiers. The CAD data in the dimensions can be downloaded from our website.

Reflective type fibers



Dimensions are listed in the order of thru-beam type, retroreflective type, and reflective type, and in alphabetic order of the Model No.

FD-H13-FM2

Free-cut

Details of sensing part

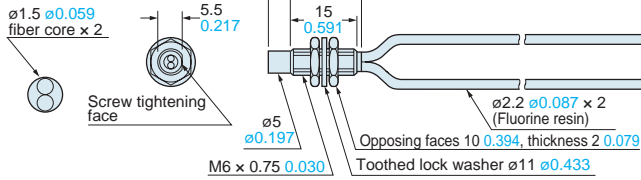

FD-H18-L31

Free-cut

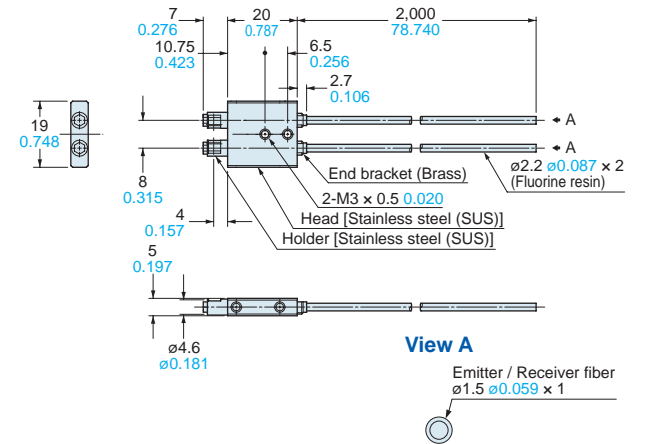

FD-H20-21

Details of sensing part

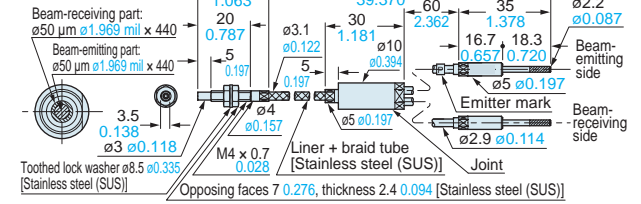

FD-H20-M1

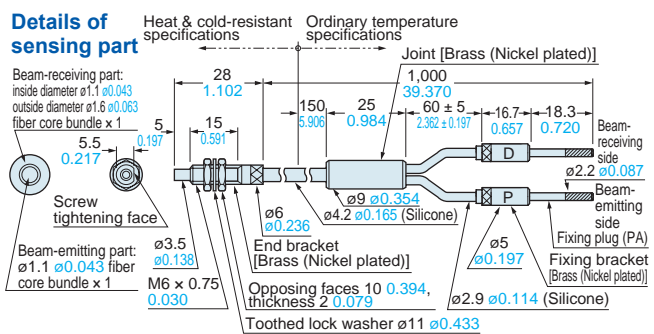

FD-H25-L43

<with FX-AT2>

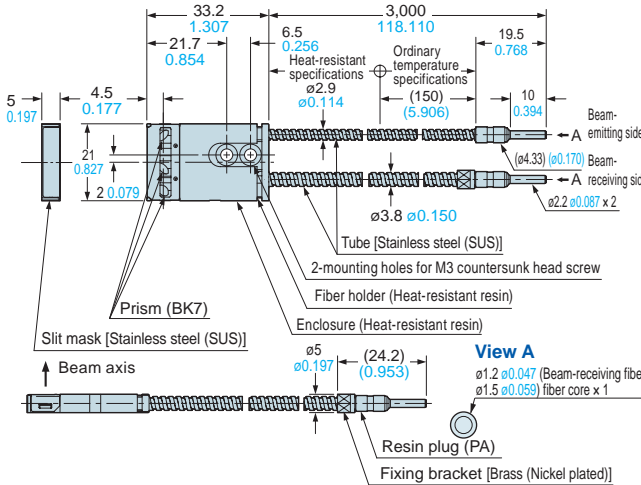

FD-H25-L45

<with FX-AT2>

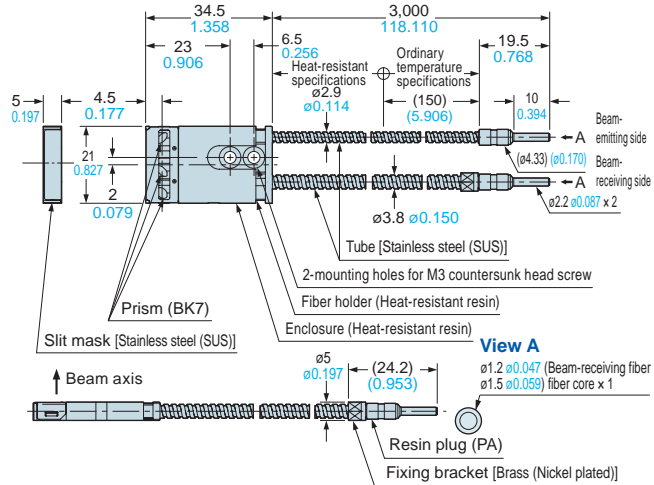

DIMENSIONS (Unit: mm in)

Refer to the **FX-500 series** (p.96), **FX-100 series** (p.110) for dimensions of the amplifiers. The CAD data in the dimensions can be downloaded from our website.

Reflective type fibers



Dimensions are listed in the order of thru-beam type, retroreflective type, and reflective type, and in alphabetic order of the Model No.

FD-H30-KZ1V-S

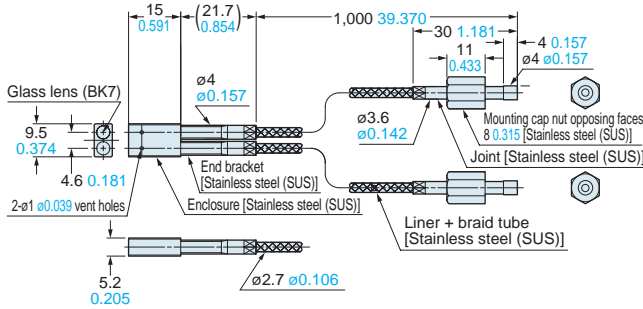

Assembly dimensions with MS-FD-2 (attached mounting bracket)

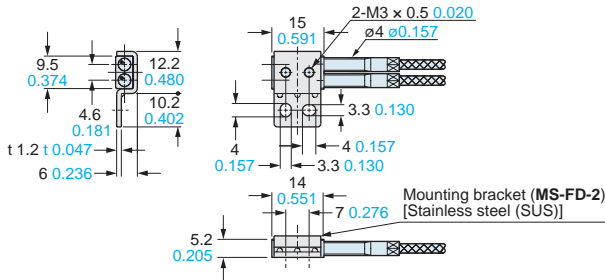

Note: The **FD-H30-KZ1V-S** is a set with the **FD-H30-KZ1V**, photo-terminal, and atmospheric side fiber. Refer to p.66 for dimensions of the atmospheric side fiber and photo-terminals.

FD-H30-L32

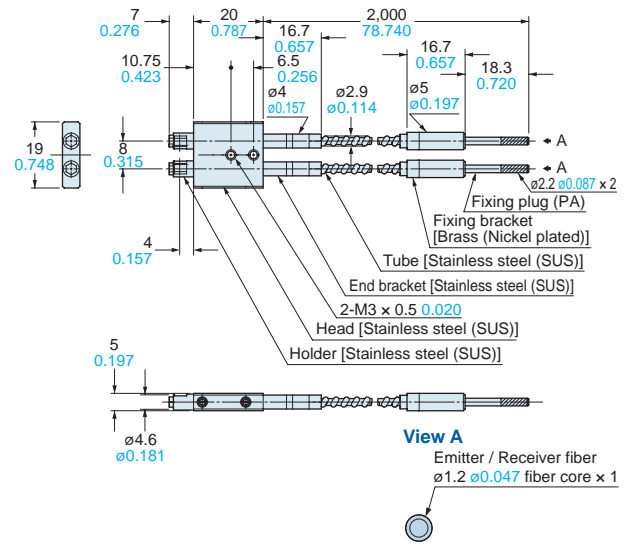

FD-H30-L32V-S

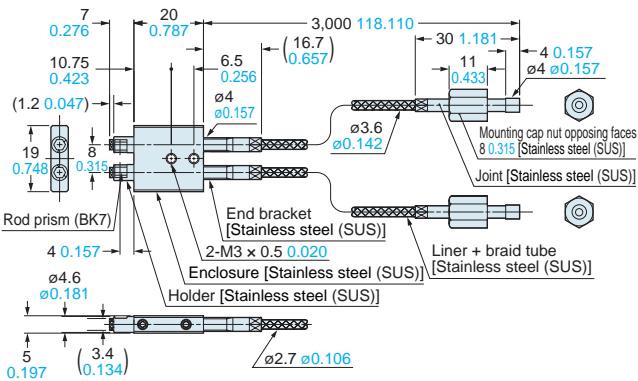

Note: The **FD-H30-L32V-S** is a set with the **FD-H30-L32V**, photo-terminal, and atmospheric side fiber. Refer to p.66 for dimensions of the atmospheric side fiber and photo-terminals.

FD-H35-20S

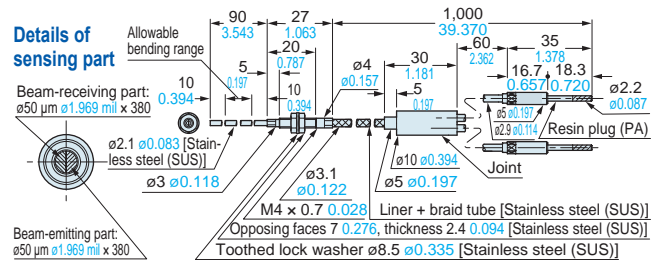

FD-H35-M2

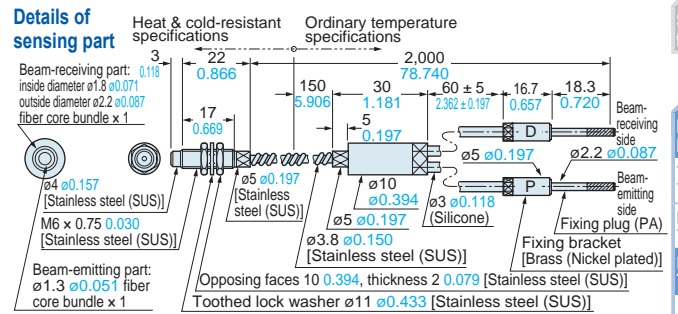

FD-H35-M2S6

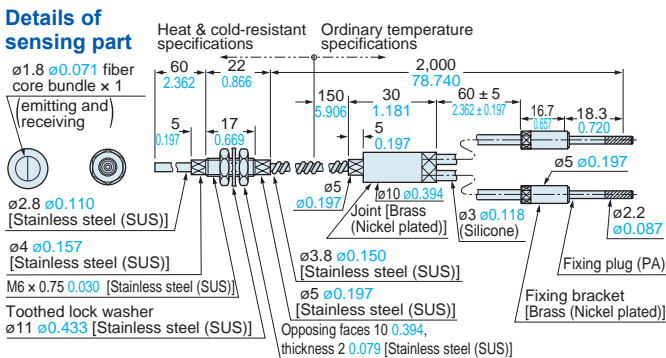

FD-HF40Y

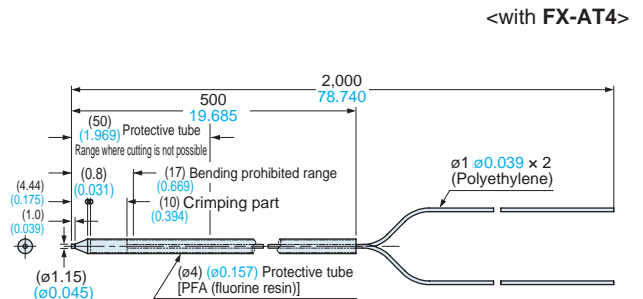

New product introduction
Tough Fiber

Fiber Selection Guide

Model

Choose by shape/application

How to read Model No.

Earlier models comparison table

Fibers

Super Quality

Threaded Type

Square Head Type

Cylindrical Type

Sleeve

Flat Type

Small Spot

Narrow Beam

Wide Beam

Convergent Reflective Type

Retroreflective Type

Chemical / Oil-resistant

Heat-resistant

Vacuum-resistant

Liquid Leak / Liquid Detection

Fiber Options

Semi-custom fibers

Fiber Dimensions

Thru-beam Type

Retroreflective Type

Reflective Type

Others

Amplifiers

FX-500 series

FX-100 series

INDEX

DIMENSIONS (Unit: mm in)

Refer to the FX-500 series (p.96), FX-100 series (p.110) for dimensions of the amplifiers. The CAD data in the dimensions can be downloaded from our website.

Reflective type fibers



Dimensions are listed in the order of thru-beam type, retroreflective type, and reflective type, and in alphabetic order of the Model No.

FD-L10

Free-cut

<with FX-AT6>

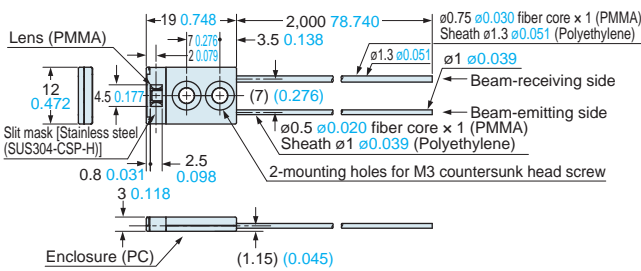

FD-L11

Free-cut

<with FX-AT6>

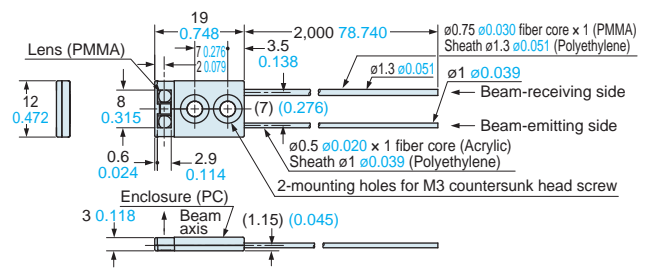

FD-L12W

Free-cut

<with FX-AT4>

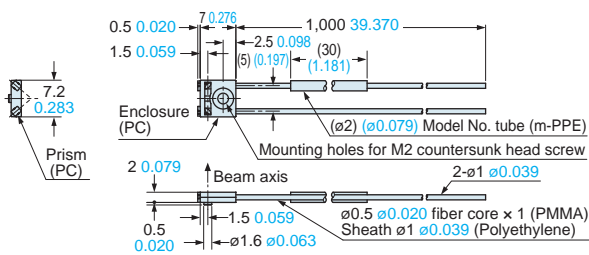

FD-L20H

Free-cut

<with FX-AT4>

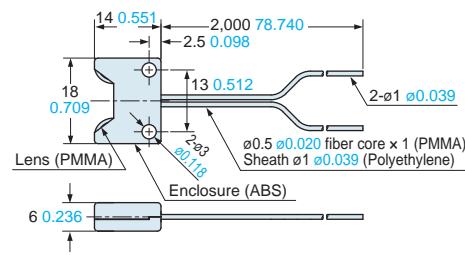

FD-L21

Free-cut

<with FX-AT4>

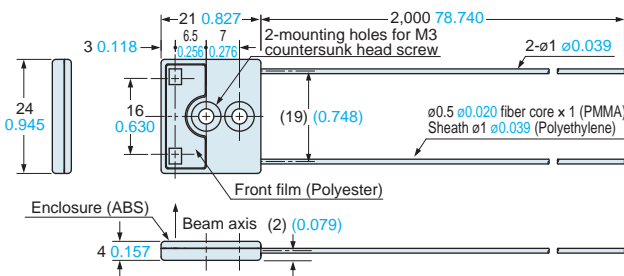

FD-L21W

Free-cut

<with FX-AT4>

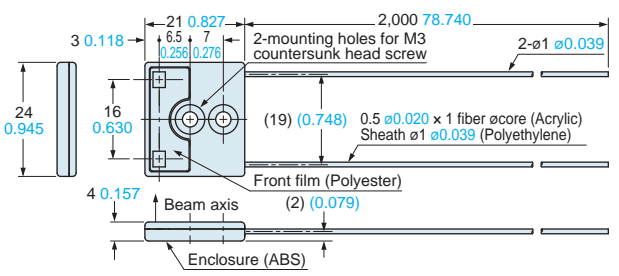

FD-L22A

Free-cut

<with FX-AT5>

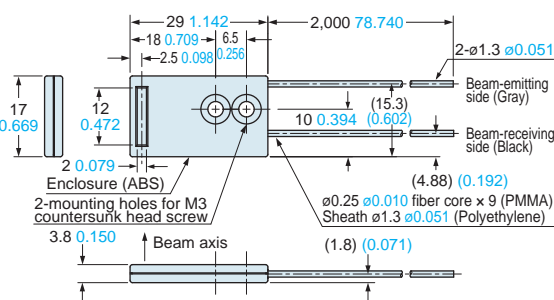

FD-L23

Free-cut

<with FX-AT5>

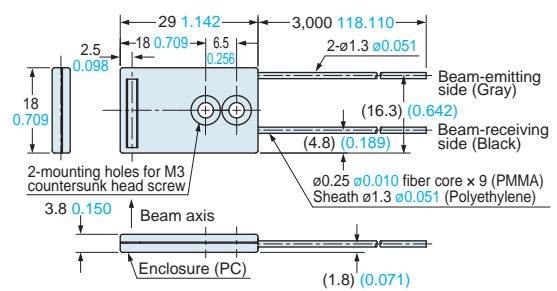

FD-L30A

Free-cut

<with FX-AT5>

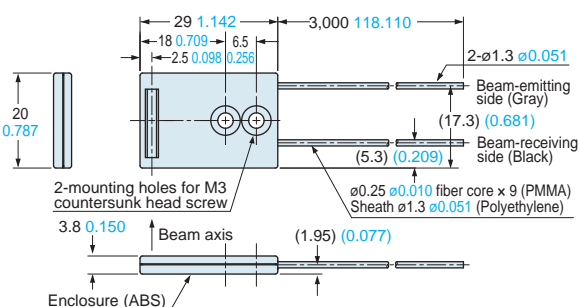

FD-L31A

Free-cut

<with FX-AT3>

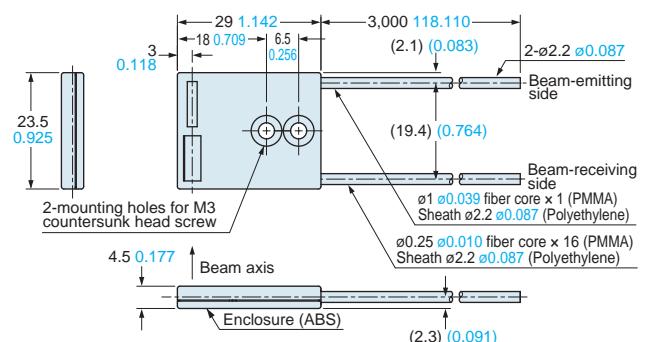

New product introduction
Tough Fiber

Fiber Selection Guide

Model
Choose by shape/application
How to read Model No
Earlier models comparison table

Fibers

Super Quality
Threaded Type
Square Head Type
Cylindrical Type
Sleeve
Flat Type
Small Spot
Narrow Beam
Wide Beam
Convergent Reflective Type
Retroreflective Type
Chemical / Oil-resistant
Heat-resistant
Vacuum-resistant
Liquid Leak / Liquid Detection

Fiber Options

Semi-custom fibers

Fiber Dimensions

Thru-beam Type
Retroreflective Type
Reflective Type

Others

Amplifiers

FX-500 series
FX-100 series

INDEX

DIMENSIONS (Unit: mm in) Refer to the **FX-500 series** (p.96), **FX-100 series** (p.110) for dimensions of the amplifiers. The CAD data in the dimensions can be downloaded from our website.

Reflective type fibers

Dimensions are listed in the order of thru-beam type, retroreflective type, and reflective type, and in alphabetic order of the Model No.

FD-L32H **Free-cut**

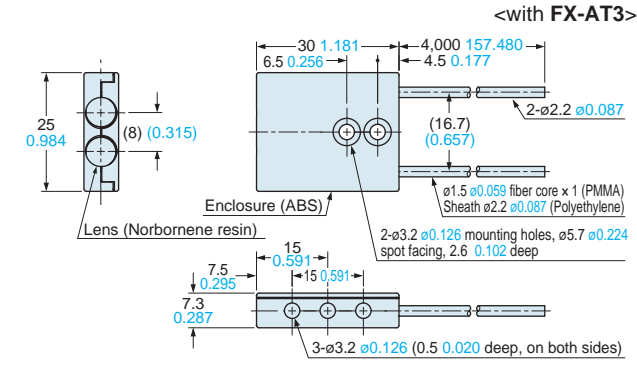

FD-R31G **Free-cut**

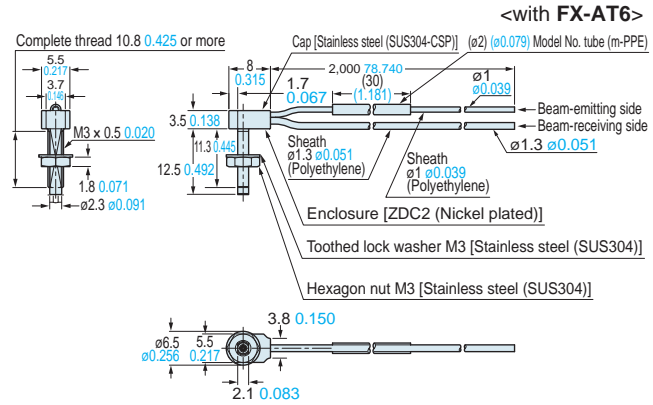

FD-R32EG, FD-R34EG

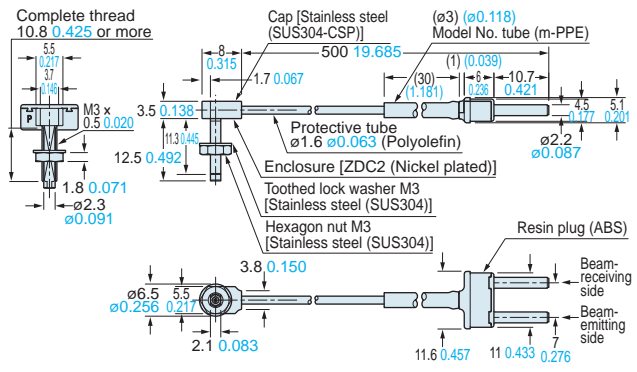

FD-R33EG

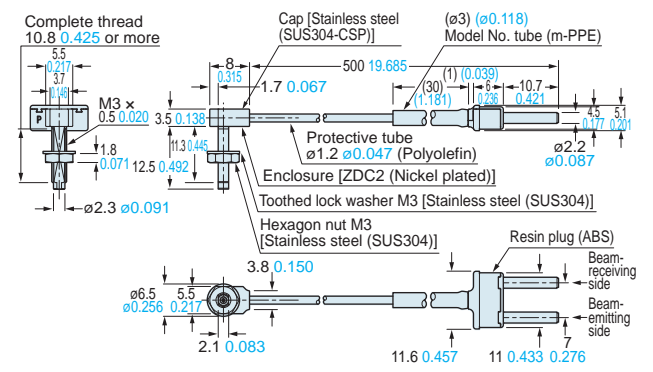

FD-R41 **Free-cut**

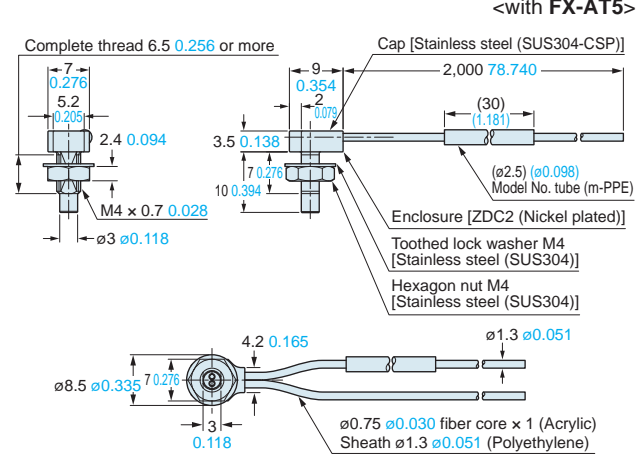

FD-R60 **Free-cut**

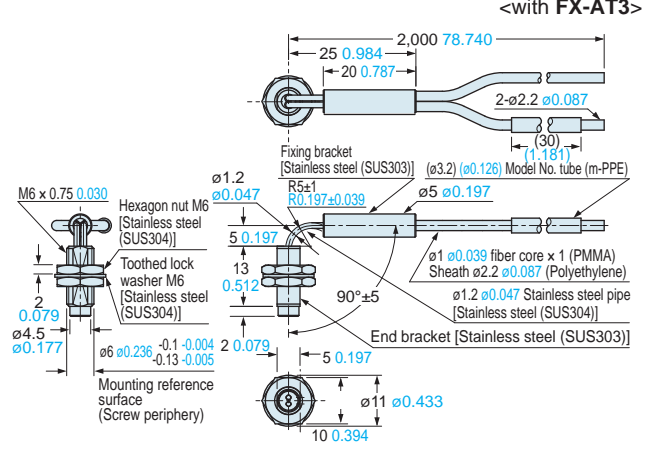

FD-R61Y **Free-cut**

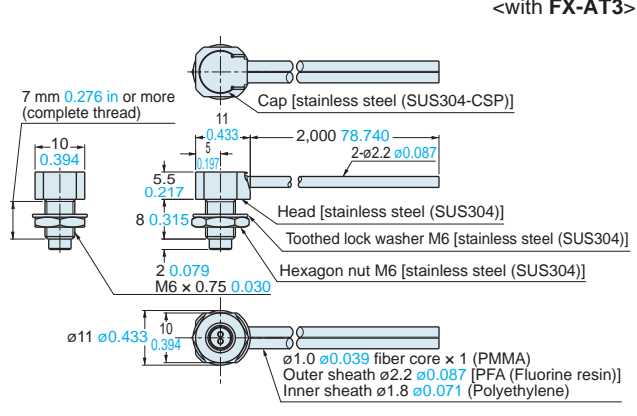

FD-S21

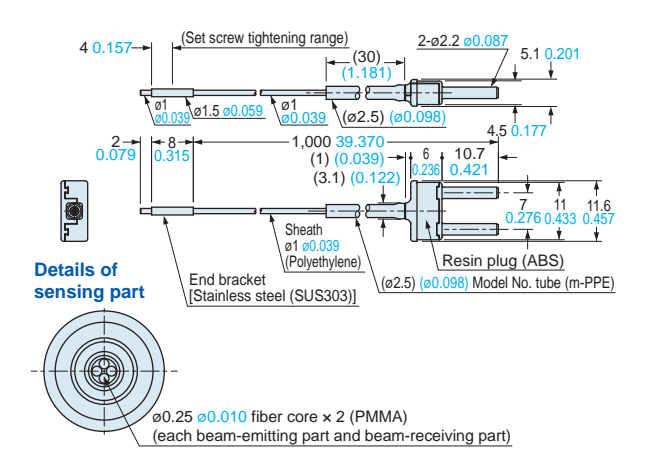

New product introduction

Tough Fiber

Fiber Selection Guide

Model

Choose by shape/application

How to read Model No.

Earlier models comparison table

Fibers

Super Quality

Threaded Type

Square Head Type

Cylindrical Type

Sleeve

Flat Type

Small Spot

Narrow Beam

Wide Beam

Convergent Reflective Type

Retroreflective Type

Chemical / Oil-resistant

Heat-resistant

Vacuum-resistant

Liquid Leak / Liquid Detection

Fiber Options

Semi-custom fibers

Fiber Dimensions

Thru-beam Type

Retroreflective Type

Reflective Type

Others

Amplifiers

FX-500 series

FX-100 series

INDEX

DIMENSIONS (Unit: mm in)

Refer to the FX-500 series (p.96), FX-100 series (p.110) for dimensions of the amplifiers. The CAD data in the dimensions can be downloaded from our website.

Reflective type fibers

Dimensions are listed in the order of thru-beam type, retroreflective type, and reflective type, and in alphabetic order of the Model No.

FD-S30

<with FX-AT2>

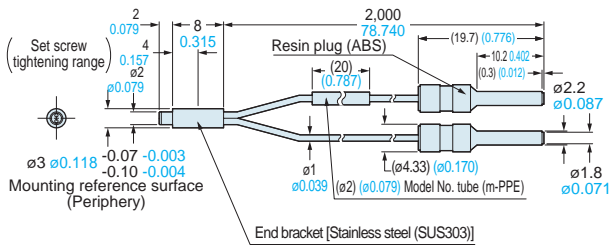
**FD-S31**

Free-cut <with FX-AT4>

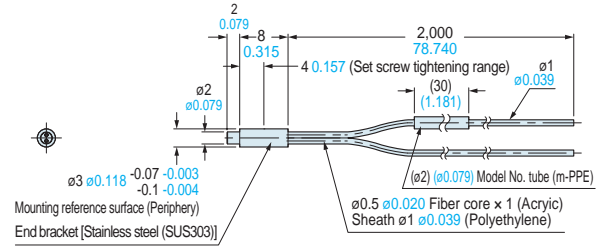
**FD-S32**

Free-cut <with FX-AT5>

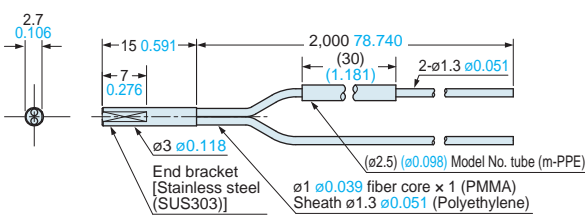
**FD-S32W**

Free-cut <with FX-AT5>

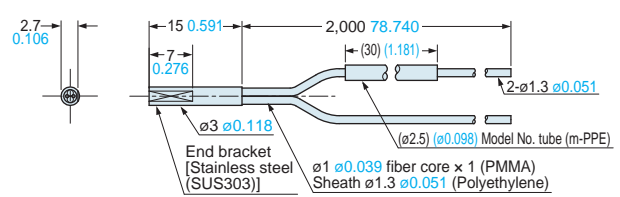
**FD-S33GW**

Free-cut <with FX-AT6>

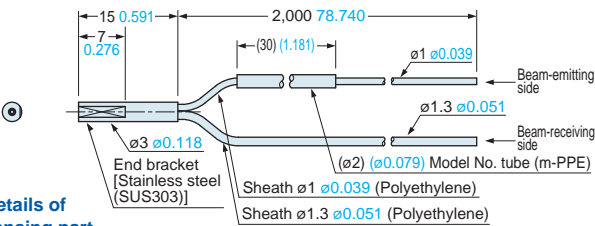
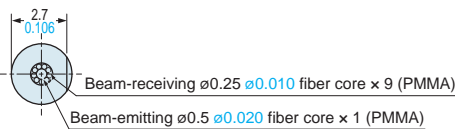
**Details of sensing part****FD-S60Y**

Free-cut <with FX-AT5>

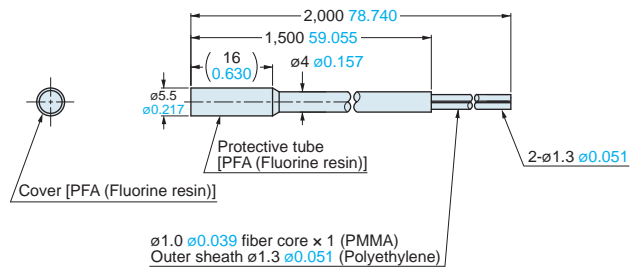
**FD-V30**

Free-cut <with FX-AT4>

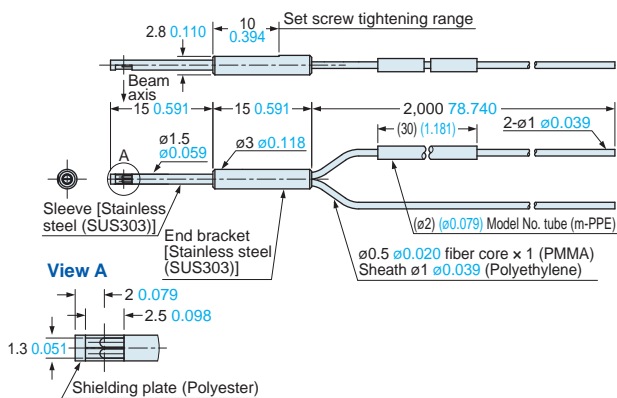
**FD-V30W**

Free-cut <with FX-AT4>

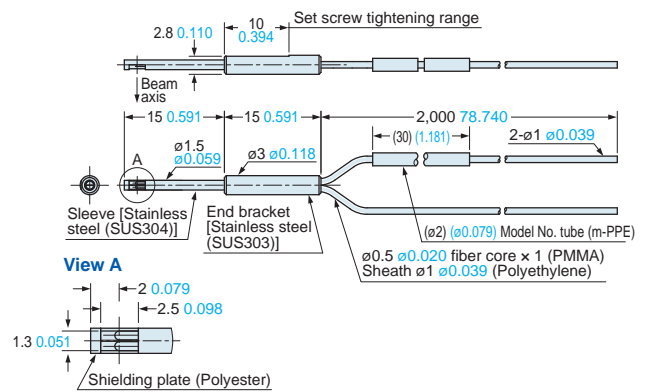

DIMENSIONS (Unit: mm in) Refer to the **FX-500 series** (p.96), **FX-100 series** (p.110) for dimensions of the amplifiers. The CAD data in the dimensions can be downloaded from our website.

Reflective type fibers 

Dimensions are listed in the order of thru-beam type, retroreflective type, and reflective type, and in alphabetic order of the Model No.

FD-V50  Free-cut

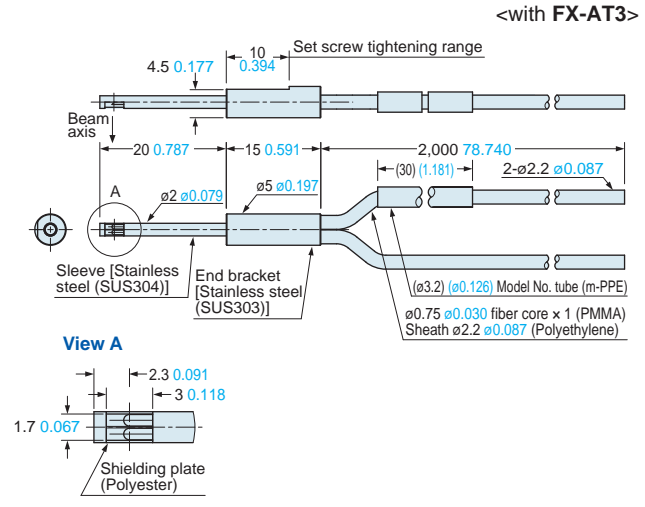

FD-Z20HBW  Free-cut

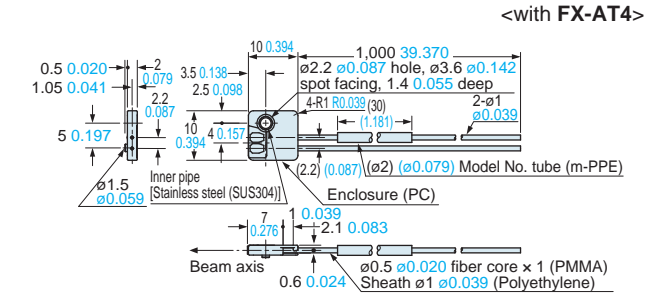

FD-Z20W  Free-cut

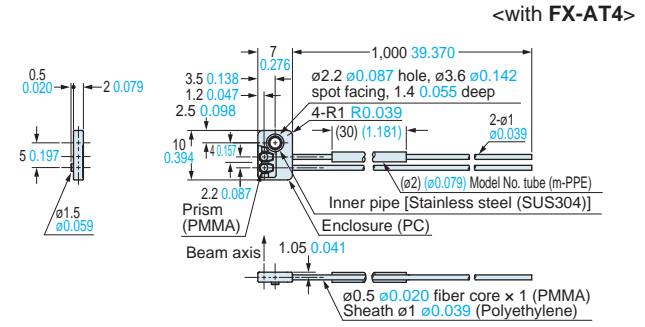

FD-Z40HBW  Free-cut

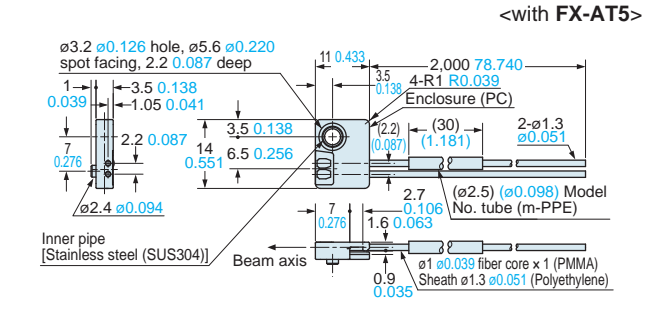

FD-Z40W  Free-cut

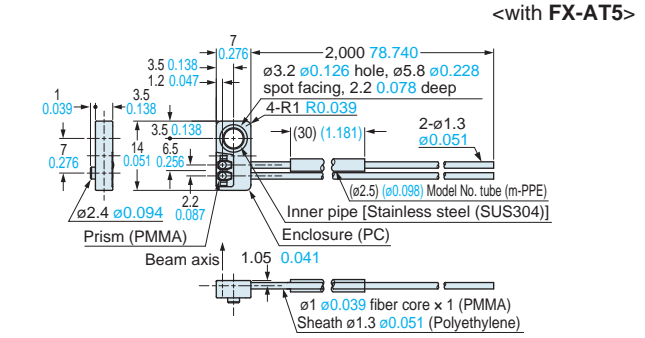

FD-Z50HW  Free-cut

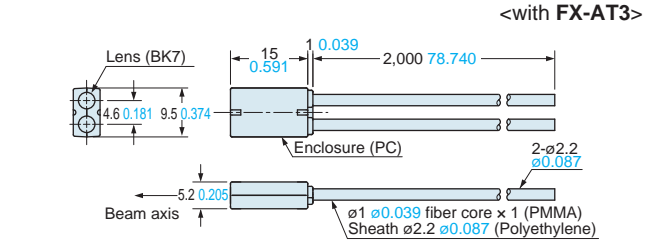

Assembly dimensions with MS-FD-2 (attached mounting bracket)

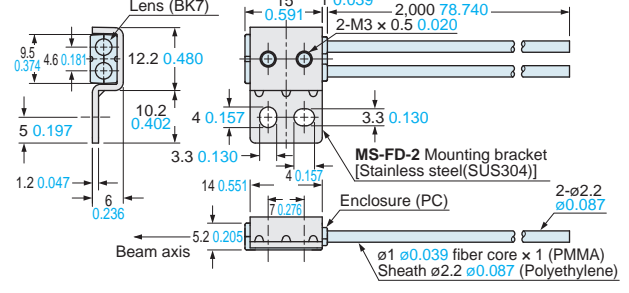

New product introduction
Tough Fiber
Fiber Selection Guide
Model
Choose by shape/application
How to read Model No.
Earlier models comparison table

Fibers
Super Quality
Threaded Type
Square Head Type
Cylindrical Type
Sleeve
Flat Type
Small Spot
Narrow Beam
Wide Beam
Convergent Reflective Type
Retroreflective Type
Chemical / Oil-resistant
Heat-resistant
Vacuum-resistant
Liquid Leak / Liquid Detection

Fiber Options

Semi-custom fibers

Fiber Dimensions
Thru-beam Type
Retroreflective Type
Reflective Type
Others

Amplifiers
FX-500 series
FX-100 series

INDEX

DIMENSIONS (Unit: mm in)

Refer to the **FX-500 series** (p.96), **FX-100 series** (p.110) for dimensions of the amplifiers. The CAD data in the dimensions can be downloaded from our website.

Vacuum-resistant Atmospheric side fiber

FT-J8

Free-cut

(Accessory for vacuum-resistant fiber) <with FX-AT3>

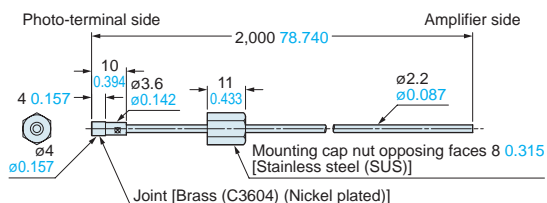

FB-1

Fiber bender (Optional)

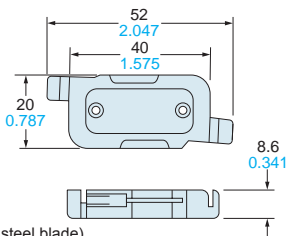

Material: PP (Containing steel blade)

FV-BR1

Photo-terminal (for vacuum-resistant) (with vacuum-resistant fiber)

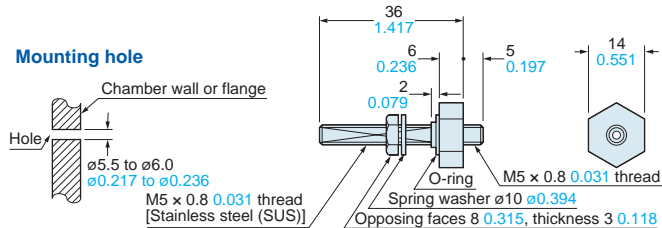

FV-LE1

Vacuum-resistant expansion lens (Optional)

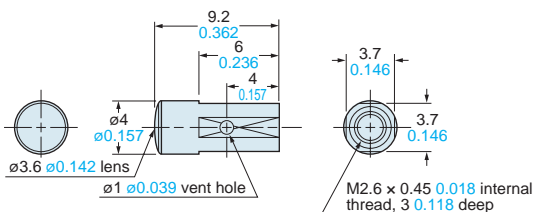

Material: Enclosure.....Aluminum alloy (A6061-T6)
Lens.....BK-7

FV-SV2

Vacuum-resistant side-view lens (Optional)

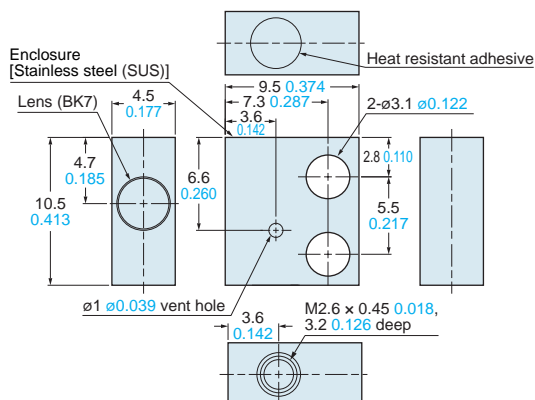

FTP-□ FDP-□

Protective tube (Optional)

FTP-□, FDP-N□

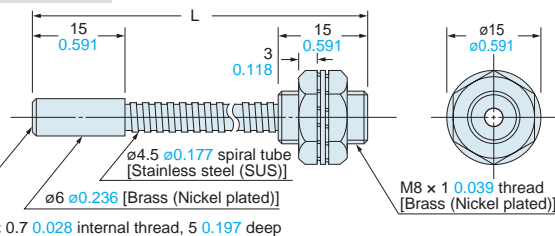

FTP-N□

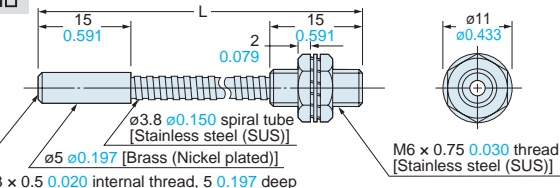

FDP-□

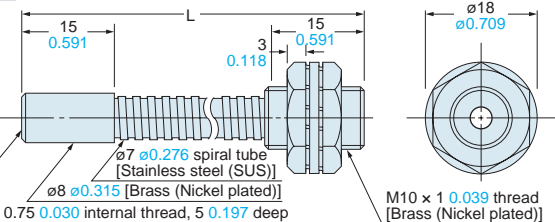

• Length L

Model No.	Length L
FTP-500, FTP-N500, FDP-N500, FDP-500	500 ⁺¹⁰ ₀ 19.685 ^{+0.394} ₀
FTP-1000, FTP-N1000, FDP-N1000, FDP-1000	1,000 ⁺¹⁰ ₀ 39.370 ^{+0.394} ₀
FTP-1500, FTP-N1500, FDP-N1500, FDP-1500	1,500 ⁺¹⁰ ₀ 59.055 ^{+0.394} ₀

New product introduction
Tough Fiber
Fiber Selection Guide
Model
Choose by shape/application
How to read Model No
Earlier models comparison table

Fibers
Super Quality
Threaded Type
Square Head Type
Cylindrical Type
Sleeve
Flat Type
Small Spot
Narrow Beam
Wide Beam
Convergent Reflective Type
Retroreflective Type
Chemical / Oil-resistant
Heat-resistant
Vacuum-resistant
Liquid Leak / Liquid Detection

Fiber Options

Semi-custom fibers

Fiber Dimensions

Others

Amplifiers
FX-500 series
FX-100 series

INDEX

DIMENSIONS (Unit: mm in) Refer to the **FX-500 series (p.96)**, **FX-100 series (p.110)** for dimensions of the amplifiers. The CAD data in the dimensions can be downloaded from our website.

FX-AT2 Attachment for fixed-length fiber (Accessory for fixed-length fiber)

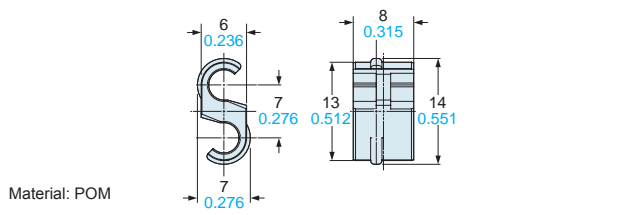

FX-AT3 Attachment for $\varnothing 2.2$ mm $\varnothing 0.087$ in fiber (Accessory for $\varnothing 2.2$ mm $\varnothing 0.087$ in fiber)

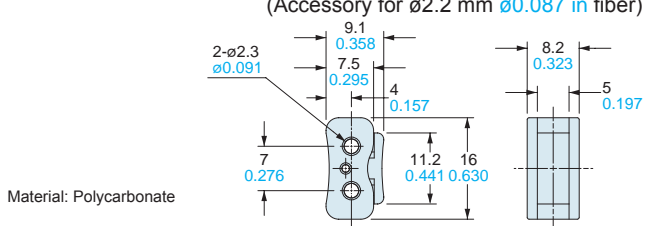

FX-AT4 Attachment for $\varnothing 1$ mm $\varnothing 0.039$ in fiber (Accessory for $\varnothing 1$ mm $\varnothing 0.039$ in fiber)

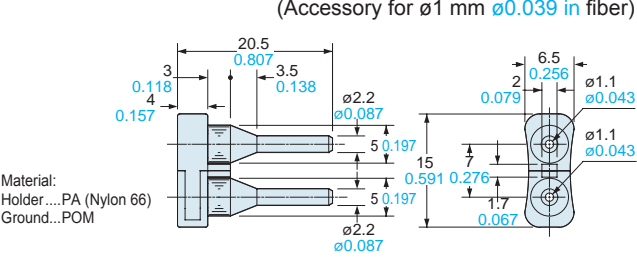

FX-AT5 Attachment for $\varnothing 1.3$ mm $\varnothing 0.051$ in fiber (Accessory for $\varnothing 1.3$ mm $\varnothing 0.051$ in fiber)

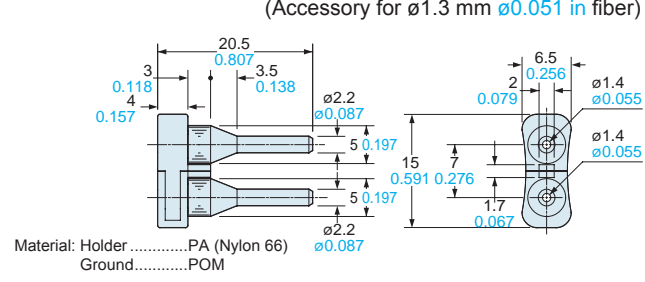

FX-AT6 Attachment for $\varnothing 1$ mm $\varnothing 0.039$ in / $\varnothing 1.3$ mm $\varnothing 0.051$ in mixed fiber (Accessory for $\varnothing 1$ mm $\varnothing 0.039$ in / $\varnothing 1.3$ mm $\varnothing 0.051$ in mixed fiber)

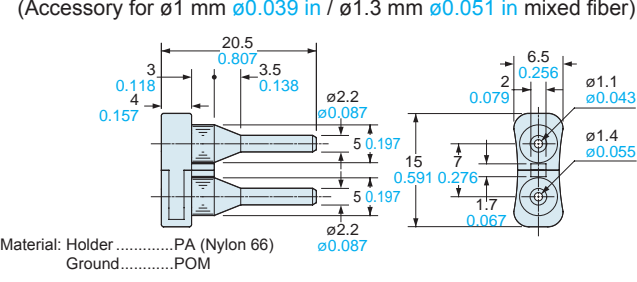

FX-CT2 Fiber cutter (Accessory for free-cut type fiber)

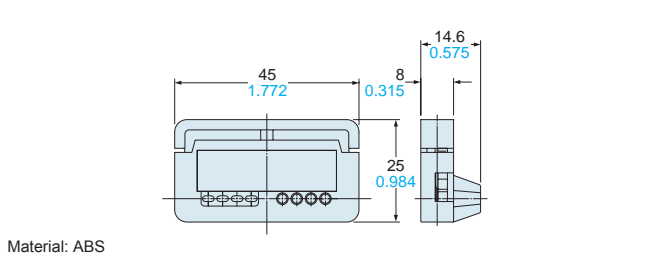

FX-LE1 Expansion lens (Optional)

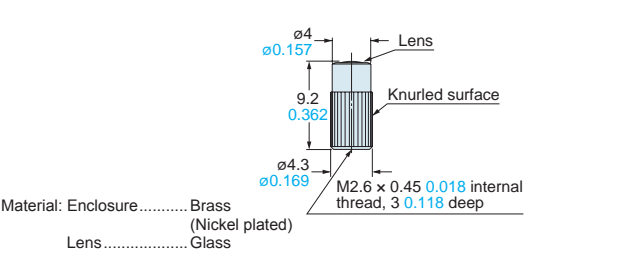

FX-LE2 Super-expansion lens (Optional)

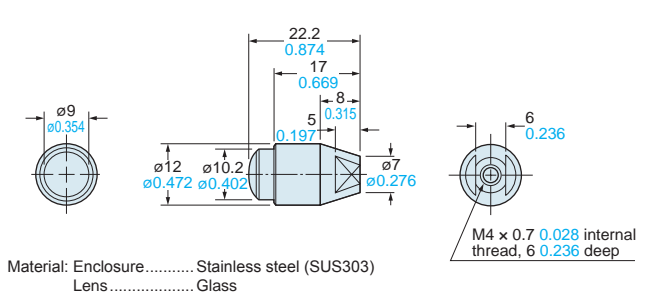

FX-MR1 Pinpoint spot lens (Optional)

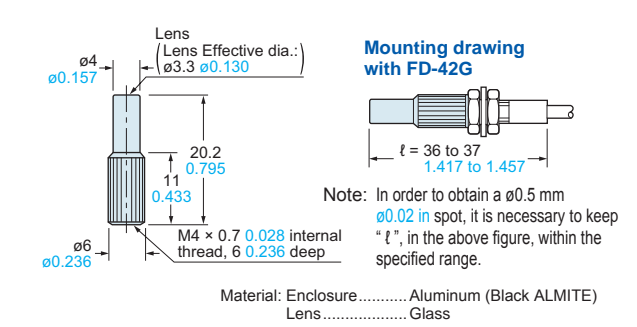

FX-MR2 Zoom lens (Optional)

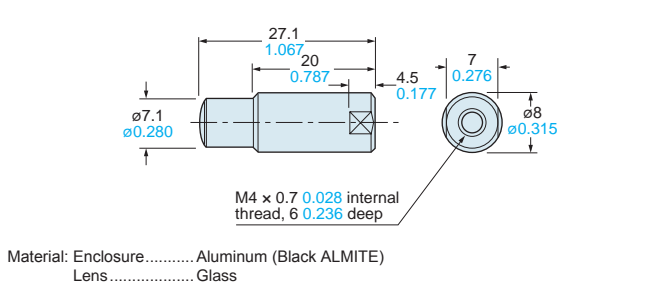

New product introduction
Tough Fiber
Fiber Selection Guide
Model
Choose by shape/application
How to read Model No.
Earlier models comparison table

Fibers
Super Quality
Threaded Type
Square Head Type
Cylindrical Type
Sleeve
Flat Type
Small Spot
Narrow Beam
Wide Beam
Convergent Reflective Type
Retroreflective Type
Chemical / Oil-resistant
Heat-resistant
Vacuum-resistant
Liquid Leak / Liquid Detection

Fiber Options

Semi-custom fibers

Fiber Dimensions
Thru-beam Type
Retroreflective Type
Reflective Type
Others

Amplifiers
FX-500 series
FX-100 series

INDEX

DIMENSIONS (Unit: mm in)

Refer to the **FX-500 series** (p.96), **FX-100 series** (p.110) for dimensions of the amplifiers. The CAD data in the dimensions can be downloaded from our website.

New product introduction
Tough Fiber

Fiber Selection Guide

Model
Choose by shape/application
How to read Model No
Earlier models comparison table

Fibers

Super Quality
Threaded Type
Square Head Type
Cylindrical Type
Sleeve
Flat Type
Small Spot
Narrow Beam
Wide Beam

Convergent Reflective Type
Retroreflective Type
Chemical / Oil-resistant
Heat-resistant
Vacuum-resistant
Liquid Leak / Liquid Detection

Fiber Options

Semi-custom fibers

Fiber Dimensions

Thru-beam Type
Retroreflective Type
Reflective Type

Others

Amplifiers

FX-500 series
FX-100 series

INDEX

FX-MR3 Finest spot lens (Optional)

Mounting drawing with FD-EG30

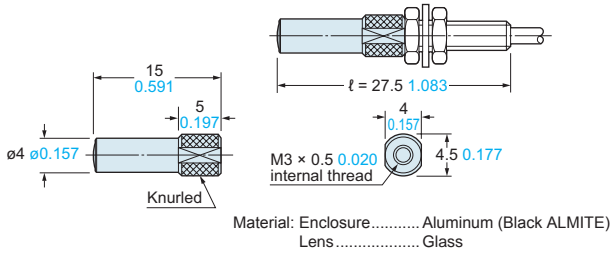

Note: When inserting the fiber, insert fully till it stops.

FX-MR5 Zoom lens (Optional)

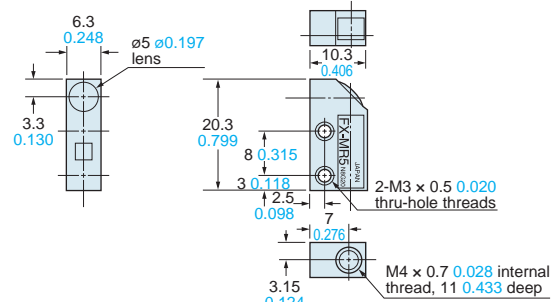

NT-FX-MR5 (exclusive nut) is attached.

FX-MR6 Finest spot lens (Optional)

Mounting drawing with FD-EG31

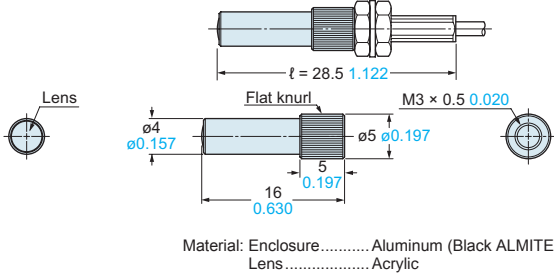

Note: When inserting the fiber, insert fully till it stops.

FX-MR7 Finest spot lens (Optional)

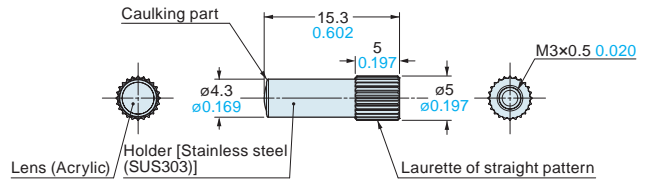

Mounting drawing with FD-R31G/R32EG/R33EG/R34EG

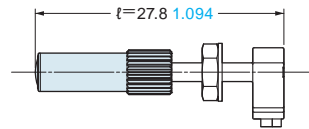

FX-MR8 Zoom lens (Optional)

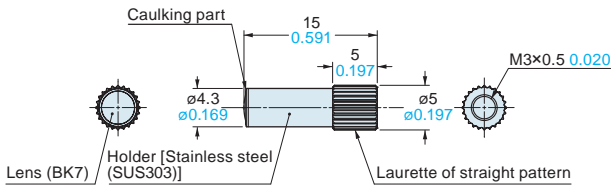

FX-MR9 Parallel light lens (Optional)

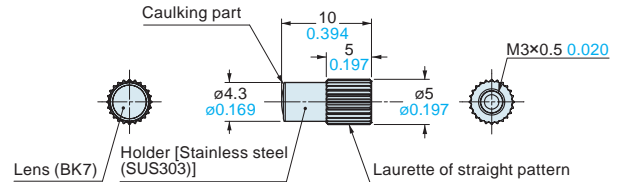

Mounting drawing with FD-R31G/R32EG/R33EG/R34EG

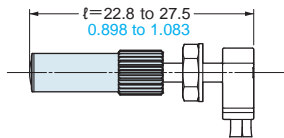

Mounting drawing with FD-R31G/R32EG/R33EG/R34EG

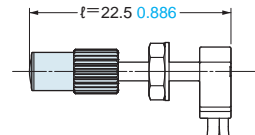

DIMENSIONS (Unit: mm in) Refer to the **FX-500 series** (p.96), **FX-100 series** (p.110) for dimensions of the amplifiers. The CAD data in the dimensions can be downloaded from our website.

FX-SV1 Side-view lens (Optional)

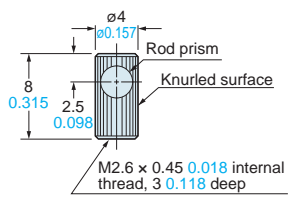

Material: Enclosure.....Brass (Nickel plated)
Lens.....Glass

MS-EX3 Mounting bracket for FX-MR2 (Accessory for FX-MR2)

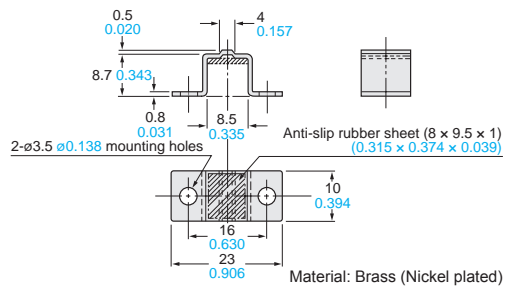

Material: Brass (Nickel plated)

MS-FD-2 Fiber mounting bracket

Accessory for FD-Z50HW, FR-KZ50E/KZ50H/Z50HW, FD-H30-KZ1V-S

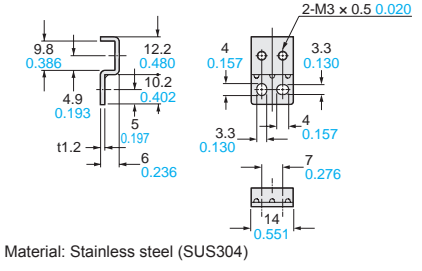

Material: Stainless steel (SUS304)

MS-FD-3 Fiber mounting bracket

Accessory for FT-KV40/FT-KV40W

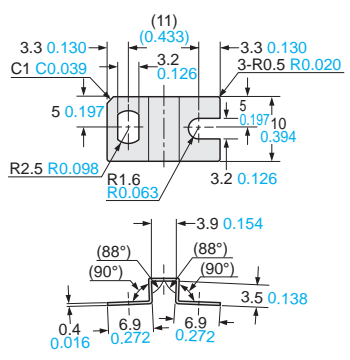

Material: Stainless steel (SUS304)

RF-003 Reflector for FR-KZ50E/KZ50H

Accessory for FR-KZ50E/KZ50H

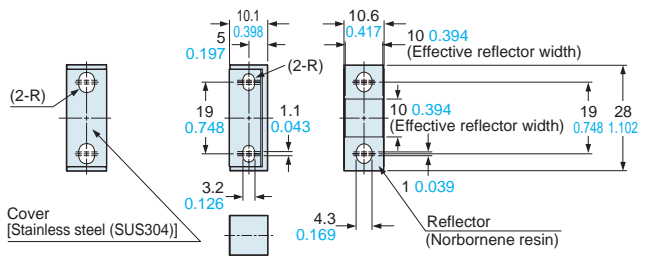

Cover [Stainless steel (SUS304)]

Reflector (Norbornene resin)

RF-13 Reflective tape for FR-Z50HW

Accessory for FR-Z50HW

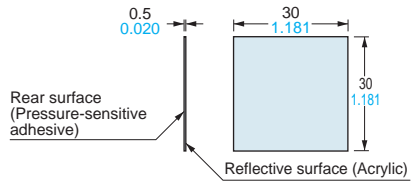

Material : Acrylic (Reflective surface)

RF-210 Reflector (Optional)

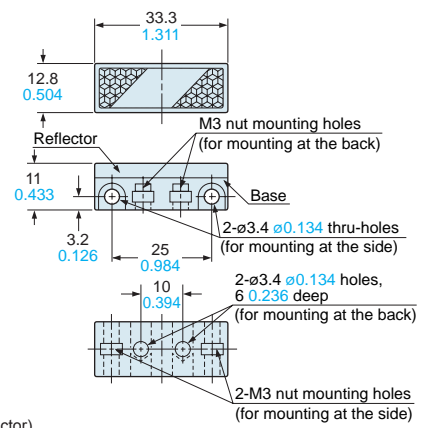

Material: Acrylic (Reflector)
ABS (Base)

Two M3 (length 8 mm 0.315 in) screws with washers and two nuts are attached.

RF-220 Reflector (Optional)

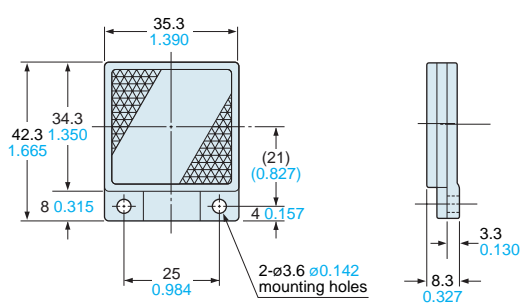

Material: Acrylic (Reflector)
ABS (Base)

RF-230 Reflector (Optional)

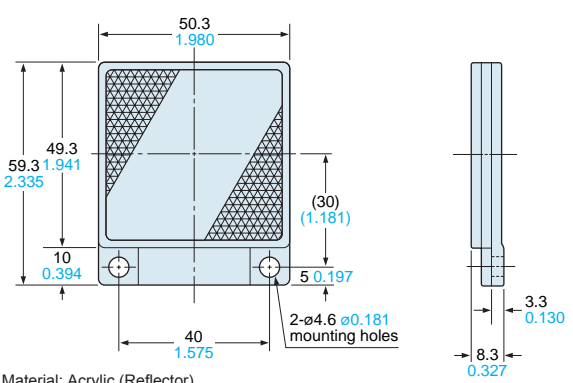

Material: Acrylic (Reflector)
ABS (Base)

New product introduction
Tough Fiber
Fiber Selection Guide
Model
Choose by shape/application
How to read Model No.
Earlier models comparison table

Fibers
Super Quality
Threaded Type
Square Head Type
Cylindrical Type
Sleeve
Flat Type
Small Spot
Narrow Beam
Wide Beam
Convergent Reflective Type
Retroreflective Type
Chemical / Oil-resistant
Heat-resistant
Vacuum-resistant
Liquid Leak / Liquid Detection

Fiber Options

Semi-custom fibers

Fiber Dimensions
Thru-beam Type
Retroreflective Type
Reflective Type
Others

Amplifiers
FX-500 series
FX-100 series

INDEX

Digital Fiber Sensor

FX-500 SERIES Ver.2

New product introduction
Tough Fiber

Fiber Selection Guide

Model

Choose by shape/application

How to read Model No

Earlier models comparison table

Fibers

Super Quality

Threaded Type

Square Head Type

Cylindrical Type

Sleeve

Flat Type

Small Spot

Narrow Beam

Wide Beam

Convergent Reflective Type

Retroreflective Type

Chemical / Oil-resistant

Heat-resistant

Vacuum-resistant

Liquid Leak / Liquid Detection

Fiber Options

Semi-custom fibers

Fiber Dimensions

Thru-beam Type

Retroreflective Type

Reflective Type

Others

Amplifiers

FX-500 series

FX-100 series

INDEX

At the industry's leading edge

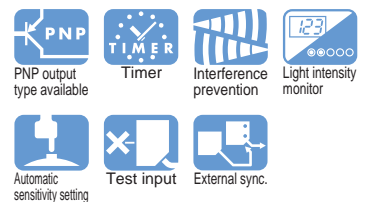
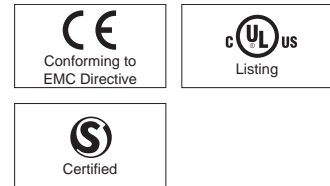
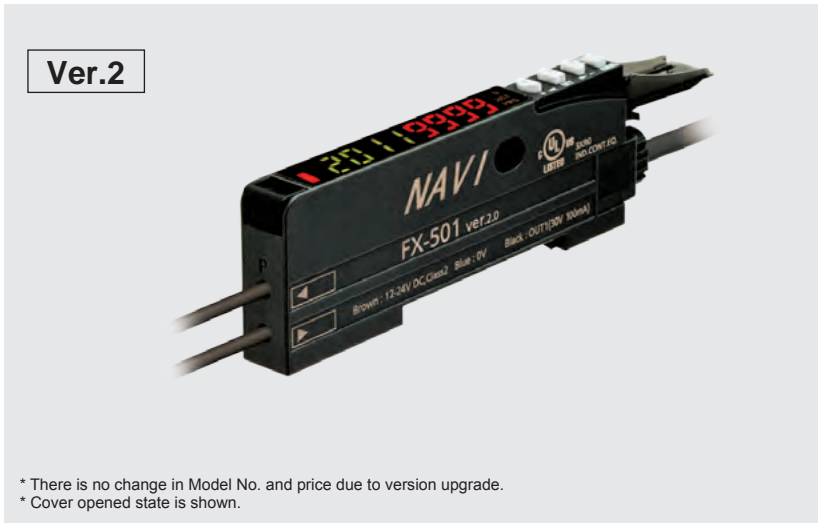

* There is no change in Model No. and price due to version upgrade.
* Cover opened state is shown.

Improved the operability and visibility of the operation keys

Operation keys (setting switch and MODE key) have been renewed to be easy to operate. Also, the color of the keys has been changed from black to light gray to achieve good visibility in dim light.

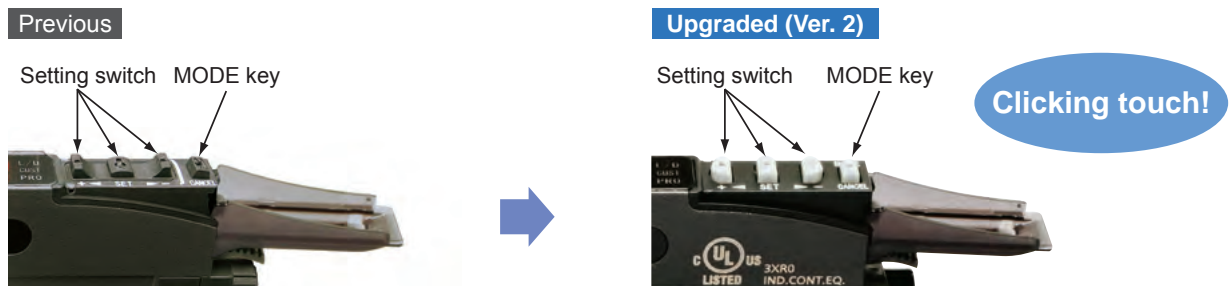

High stability!

When the **FX-500** series is used together with our super quality fiber, the incident light intensity variation among units is decreased to only 1/4 of that of conventional models. By being close to absolute values instead of modified digital values, changes in detection that could not be found in the past can now be monitored.

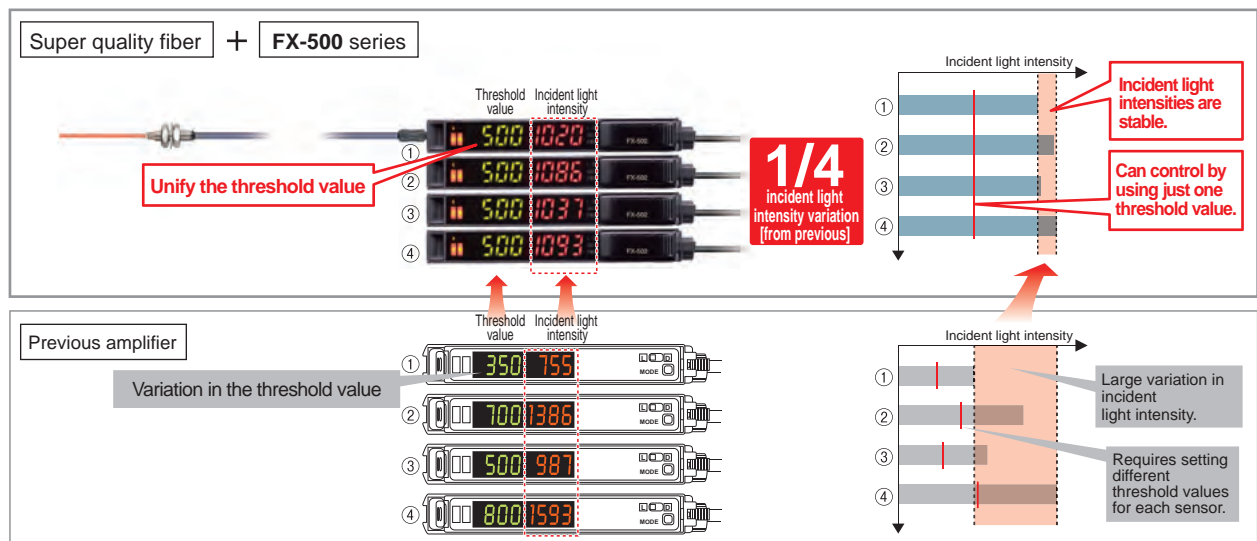

A quality that surpassed that of standard fibers!

New fibers developed using a new manufacturing method adopted by our own factory along with a persistent quality control system.
The basic performance of a standard fiber is greatly enhanced!

Stable emission amount ± 10

Variation in emission amount of the fiber core is controlled down to less than ± 10 %, achieving a stable detection.
 • Beam axis deviation: Thru-beam type within ± 2 °, Reflective type within ± 3 °
 • Beam axis centering precision: within ± 150 μ m

$\phi 2.2$ mm $\phi 0.087$ in standard fiber

New material

Single core standard fiber with high flexibility

Previous

In general, high-flexibility types adopt a multi-fiber core, which may result in large variation in light emission.

Expanded temperature range

Ambient temperature [-40 to +70 °C -40 to +158 °F in previous model]

-55 to +80 °C
-67 to +176 °F

1.2 times more than previous model

More flexible! **R4**

Bending radius [Previous model is R25 mm R0.984 in]

R4 mm
R0.157 in

1/6 of that of previous model

Integrated high-precision plug

The centering precision of the fiber core attached to the inserting plug is doubled. As the insertion precision is increased, the variation among units can be greatly suppressed.
 • Centering precision: within ± 40 μ m

More bendable!

Bending durability [Previous model is 1,000 times]

10 million times

10,000 times more than previous model

* Bending conditions
 Bending radius: R10 mm R 0.394 in,
 Reciprocating bending 180°

Max. 25 μ s response time

FX-500 with its high response time contributes to improve productivity.

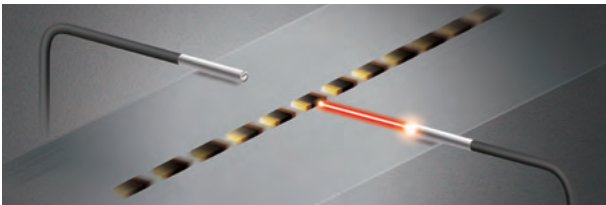

Performing minute object detection when using a small diameter fiber is now possible with a high response time and longer sensing range.

Hyper HYPR mode incorporated

FX-500 in combination with small diameter fibers which can handle challenging detections, allows long sensing range.

Tough

FX-500 HYPR mode (with FD-41)

Previous (FX-301 LONG mode) (with FD-NFM2)

Max. 5.7 times! (Note) longer than the previous model

Note: When using FD-NFM2.

So accurate! Sharp detection with suppressed hysteresis

FX-500 with its accurate detection catches fractional differences in light intensity, achieving high precision and solving low-hysteresis applications.

- Long range detection of small objects with small difference in light intensity **H-02 mode**
- Highly accurate detection while avoiding saturation **H-01 mode**

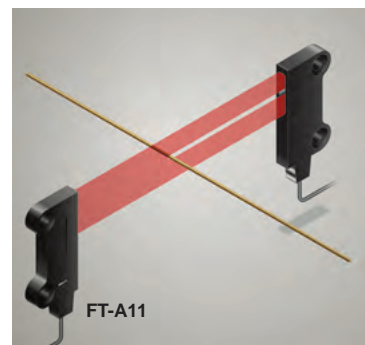
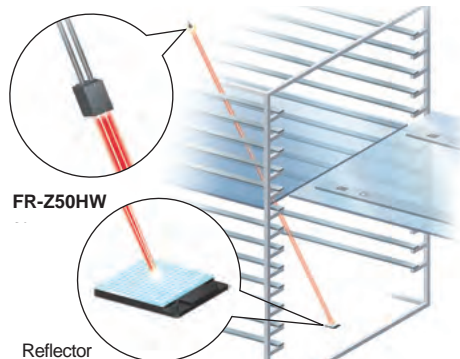

New product introduction

Tough Fiber

Fiber Selection Guide

Model

Choose by shape/application

How to read Model No.

Earlier models comparison table

Fibers

Super Quality

Threaded Type

Square Head Type

Cylindrical Type

Sleeve

Flat Type

Small Spot

Narrow Beam

Wide Beam

Convergent Reflective Type

Retroreflective Type

Chemical / Oil-resistant

Heat-resistant

Vacuum-resistant

Liquid Leak / Liquid Detection

Fiber Options

Semi-custom fibers

Fiber Dimensions

Thru-beam Type

Retroreflective Type

Reflective Type

Others

Amplifiers

FX-500 series

FX-100 series

INDEX

Flat display with wide viewing angle

The large and high-contrast 7-segment display of high luminance provides clear visibility from a wide angle of view.

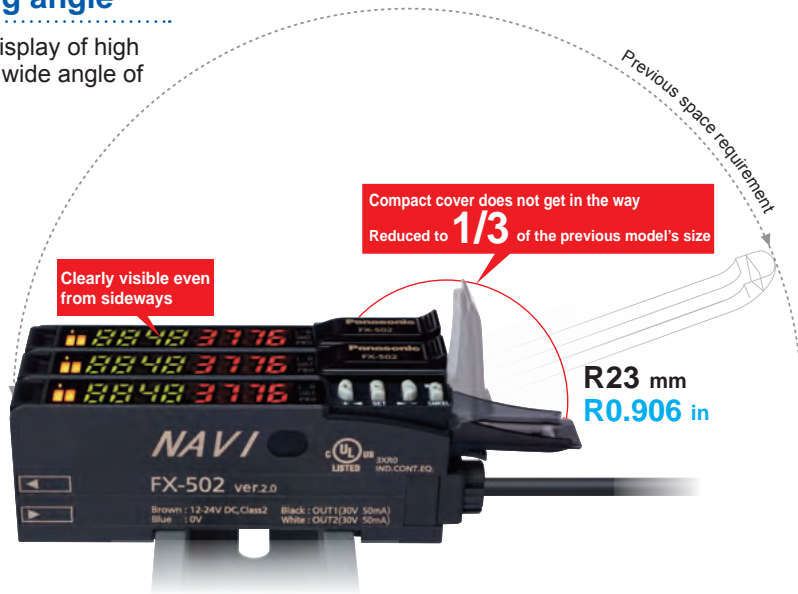

Resolves variation in displayed incident light intensity Display adjustment setting

The variation in display can be adjusted to random values. This helps to define proper instruction in a work order.

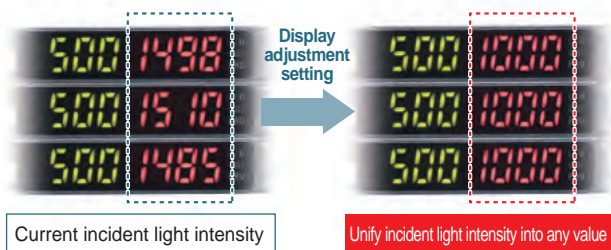

Stable detection over long and short periods Stabilized emission amount

The “four-chemical emitting element”, which we are the first to incorporate to maintain a stable level of light emission, has now become an industry standard. **FX-500** series continues to adopt the same emitting element as well as the “APC (Auto Power Control) circuit” which improves stability in short periods such as when the power is turned on.

Saves maintenance time Threshold tracking function

This function performs automatic setting to threshold value by checking the incident light intensity at desired intervals in order to follow the changes in the light amount resulting from changes in the environment over long periods (such as dust). This contributes to reduction in maintenance hours.

Suitable for preventative maintenance Self-diagnosis output

FX-502(P)
FX-505(P)-C2

FX-502(P) / 505(P)-C2 can set Output 2 as a self-diagnosis output. When the teaching of Output 1's threshold value is carried out, Output 2 is set concurrently with the setting randomly shifted by the amount of surplus of threshold value. Light intensity deterioration due to fiber breakage or dust accumulation can be notified as an alarm output.

- Detect deterioration in light intensity (e.g. Useful in dusty environment)



Self-diagnosis can be used with the threshold tracking function for added effectiveness.

Stable detection while being eco-friendly Emission power & gain setting

In cases when the incident light intensity is saturated, the light emitting amount can be adjusted to the optimal level by AUTO without changing the response time. This allows stable detection with an optimal S/N ratio and saves energy by controlling the emitting electric current.

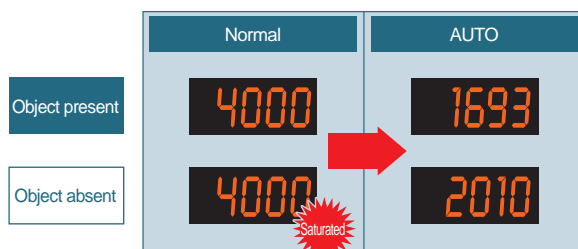

Auto mode (AUTO) and 3-level manual mode (H / M / L [fine-adjustable]) are incorporated.

- Detecting a transparent sheet

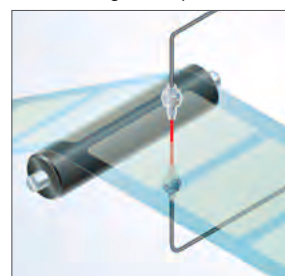

New product introduction
Tough Fiber
Fiber Selection Guide
Model
Choose by shape/application
How to read Model No
Earlier models comparison table

Fibers
Super Quality
Threaded Type
Square Head Type
Cylindrical Type
Sleeve
Flat Type
Small Spot
Narrow Beam
Wide Beam
Convergent Reflective Type
Retroreflective Type
Chemical / Oil-resistant
Heat-resistant
Vacuum-resistant
Liquid Leak / Liquid Detection

Fiber Options

Semi-custom fibers

Fiber Dimensions
Thru-beam Type
Retroreflective Type
Reflective Type
Others

Amplifiers
FX-500 series
FX-100 series

INDEX

Built-in logic functions No PLC necessary, saving material and programming costs

Logical calculation functions

3 logical calculations (AND, OR, XOR) are available with fiber sensor only. 3 logical operations can be selected against Output 1. Additional controller is not required so both wire-saving and cost reduction can be achieved.

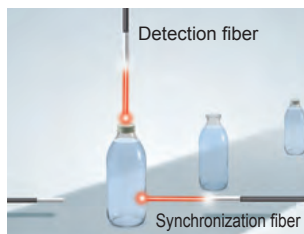

Calculation of two neighboring amplifiers

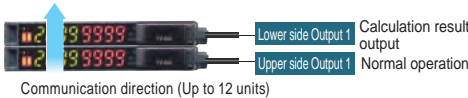

Calculation of two outputs in one amplifier FX-502(P) / 505(P)-C2



Calculation of one amplifier and external input FX-502(P) / 505(P)-C2



Equipped with 5 timer types

A wide variety of timer control operations can be carried out by fiber sensors only.

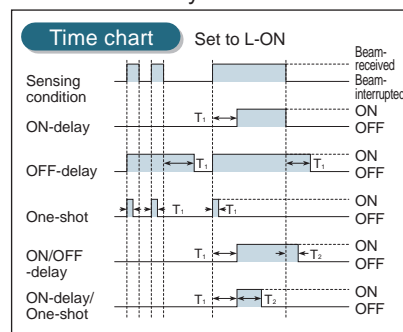

Timer period: 0.05 ms to 32 s
Output 1 has ON / OFF-delay and ON-delay / One-shot timers are available.

Analog output cable type FX-505(P)-C2

To monitor the sensing of objects, a 4 to 20 mA analog current is output in response to the digital value of the incident light intensity.

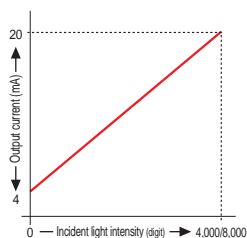

Edge tracking of film or sheet

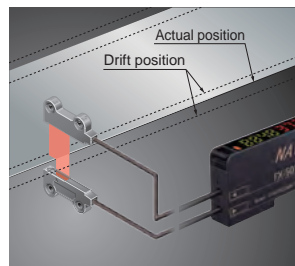

The drifting path can be monitored as the light intensity changes.

Smooth setup changes by 8 data banks

The number of data banks used for saving the setup conditions of the amplifier is increased to eight. Setup conditions can be saved and loaded to make setup changes easy at a worksite where multiple models are manufactured.

Remote control improves work efficiency by external input FX-502(P) / FX-505(P)-C2

Work efficiency can be improved by operating via PLC output or other external signal.

(FX-502(P)) can operate via external signal when switching from Output 2 to external input.)

Functions operable by external input

Full-auto / Limit / 2-point teaching	Display adjustment setting
Data bank load / save	Logical calculation (self-unit only)
Emission halt	Copying function lock (self-unit only)

An optical communication function allows sensors to be adjusted simultaneously

The data that is currently set can be copied and saved all at once for all amplifiers connected together from the right side thanks to the optical communication function. This greatly reduces troublesome setup tasks and makes setup much smoother.



No need to specify a main unit or sub unit

All FX-500 amplifiers can be used as either a main unit or a sub unit. Just use a main cable or a sub cable to distinguish the two. This reduces the costs of inventory management.

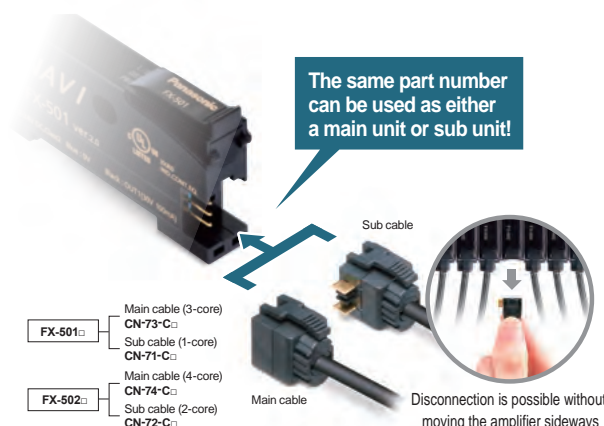

New product introduction
Tough Fiber

Fiber Selection Guide
Model

Choose by shape/application
How to read Model No.
Earlier models comparison table

Fibers
Super Quality

Threaded Type
Square Head Type

Cylindrical Type
Sleeve

Flat Type
Small Spot

Narrow Beam
Wide Beam

Convergent Reflective Type
Retroreflective Type

Chemical / Oil-resistant
Heat-resistant

Vacuum-resistant
Liquid Leak / Liquid Detection

Fiber Options

Semi-custom fibers

Fiber Dimensions
Thru-beam Type

Retroreflective Type
Reflective Type

Others

Amplifiers

FX-500 series
FX-100 series



INDEX

ORDER GUIDE

New product introduction
Tough Fiber

Amplifiers

Quick-connection cable is not supplied with **FX-501(P)** and **FX-502(P)**. Please order it separately.

Type	Appearance	Model No.	Emitting element	Output	External input
Standard type		FX-501	Red LED	NPN open-collector transistor	—
		FX-501P		PNP open-collector transistor	
2-output type		FX-502		NPN open-collector transistor 2 outputs	Incorporated (Switchable with Output 2)
		FX-502P		PNP open-collector transistor 2 outputs	
Cable type		FX-505-C2	NPN open-collector transistor 2 outputs, analog output	Incorporated	
		FX-505P-C2	PNP open-collector transistor 2 outputs, analog output		

Quick-connection cables

For FX-501(P) Quick-connection cable is not supplied with the amplifier. Please order it separately.

Type	Model No.	Description	
Main cable (3-core)	CN-73-C1	Length: 1 m 3.281 ft	0.2 mm ² 3-core cabtyre cable, with connector on one end Cable outer diameter: \varnothing 3.3 mm \varnothing 0.130 in
	CN-73-C2	Length: 2 m 6.562 ft	
	CN-73-C5	Length: 5 m 16.404 ft	
Sub cable (1-core)	CN-71-C1	Length: 1 m 3.281 ft	0.2 mm ² 1-core cabtyre cable, with connector on one end Cable outer diameter: \varnothing 3.3 mm \varnothing 0.130 in Connectable to a main cable up to 15 cables.
	CN-71-C2	Length: 2 m 6.562 ft	
	CN-71-C5	Length: 5 m 16.404 ft	

Main cable

- **CN-73-C□**

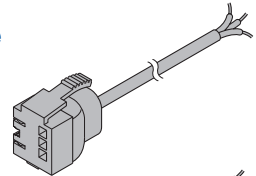

Sub cable

- **CN-71-C□**

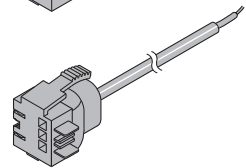

For FX-502(P) Quick-connection cable is not supplied with the amplifier. Please order it separately.

Type	Model No.	Description	
Main cable (4-core)	CN-74-C1	Length: 1 m 3.281 ft	0.2 mm ² 4-core cabtyre cable, with connector on one end Cable outer diameter: \varnothing 3.3 mm \varnothing 0.130 in
	CN-74-C2	Length: 2 m 6.562 ft	
	CN-74-C5	Length: 5 m 16.404 ft	
Sub cable (2-core)	CN-72-C1	Length: 1 m 3.281 ft	0.2 mm ² 2-core cabtyre cable, with connector on one end Cable outer diameter: \varnothing 3.3 mm \varnothing 0.130 in Connectable to a main cable up to 15 cables.
	CN-72-C2	Length: 2 m 6.562 ft	
	CN-72-C5	Length: 5 m 16.404 ft	

Main cable

- **CN-74-C□**

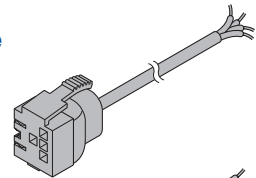

Sub cable

- **CN-72-C□**

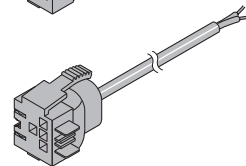

End plates End plates are not supplied with the amplifier. Please order them separately when the amplifiers are mounted in cascade.

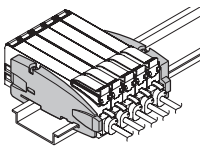
Appearance	Model No.	Description
	MS-DIN-E	When amplifiers are mounted in cascade, or when an amplifier moves depending on the way it is installed on a DIN rail, these end plates clamp amplifiers into place on both sides. Make sure to use end plates when cascading multiple amplifiers together. Two pcs. per set

Fiber Selection Guide

Model

Choose by shape/application

How to read Model No

Earlier models comparison table

Fibers

Super Quality

Threaded Type

Square Head Type

Cylindrical Type

Sleeve

Flat Type

Small Spot

Narrow Beam

Wide Beam

Convergent Reflective Type

Retroreflective Type

Chemical / Oil-resistant

Heat-resistant

Vacuum-resistant

Liquid Leak / Liquid Detection

Fiber Options

Semi-custom fibers

Fiber Dimensions

Thru-beam Type

Retroreflective Type

Reflective Type

Others

Amplifiers

FX-500 series

FX-100 series

INDEX

OPTIONS

Designation	Model No.	Description
Amplifier mounting bracket	MS-DIN-2	Mounting bracket for amplifier

Accessory

- **FX-MB1** (Amplifier protection seal)
10 sets of 2 communication window seals and 1 connector seal

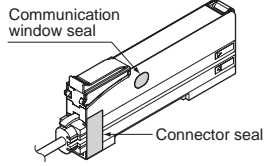

Amplifier mounting bracket

- **MS-DIN-2**

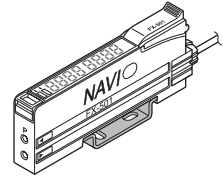

New product introduction
Tough Fiber

Fiber Selection Guide
Model
Choose by shape/application
How to read Model No.
Earlier models comparison table

Fibers
Super Quality
Threaded Type
Square Head Type
Cylindrical Type
Sleeve
Flat Type
Small Spot
Narrow Beam
Wide Beam
Convergent Reflective Type
Retroreflective Type
Chemical / Oil-resistant
Heat-resistant
Vacuum-resistant
Liquid Leak / Liquid Detection

Fiber Options

Semi-custom fibers

Fiber Dimensions
Thru-beam Type
Retroreflective Type
Reflective Type
Others

Amplifiers
FX-500 series
FX-100 series

INDEX

SPECIFICATIONS

Item	Model No.	Type	Standard type	2-output type	Cable type (Analog output type)
		NPN output	FX-501	FX-502	FX-505-C2
		PNP output	FX-501P	FX-502P	FX-505P-C2
Supply voltage	12 to 24 V DC ⁺¹⁰ / ₋₁₅ % Ripple P-P 10 % or less				
Power consumption	Normal operation: 960 mW or less (current consumption 40 mA or less at 24 V supply voltage, excluding analog output of cable type) ECO mode: 680 mW or less (current consumption 28 mA or less at 24 V supply voltage, excluding analog output of cable type)				
Output (2-output type and cable type: Output 1, Output 2)	<NPN output type> NPN open-collector transistor		<PNP output type> PNP open-collector transistor		
	<ul style="list-style-type: none"> Maximum sink current: 100 mA (2-output type and cable type are 50 mA) (Note 2) Applied voltage: 30 V DC or less (between output and 0 V) Residual voltage: 2 V or less (Note 3) (at maximum sink current) 		<ul style="list-style-type: none"> Maximum source current: 100 mA (2-output type and cable type are 50 mA) (Note 2) Applied voltage: 30 V DC or less (between output and +V) Residual voltage: 2 V or less (Note 3) (at maximum source current) 		
	Output points	1 point	2 points		
	Output operation	Switchable either Light-ON or Dark-ON by L/D mode			
Short-circuit protection	Incorporated				
Response time	H-SP: 25 μs or less, FAST: 60 μs or less, STD: 250 μs or less, LONG: 2 ms or less, U-LG: 4 ms or less, HYPR: 24 ms or less, selectable				
Analog output (Cable type only)	Output current: 4 to 20 mA approx. [H-SP, FAST, STD: At 0 to 4,000 digits, LONG: At 0 to 8,000 digits (Note 4)], Response time: 2 ms or less, Zero point: Within 4 mA ±1 % F.S., Span: Within 16 mA ±5 % F.S., Linearity: Within ±3 % F.S., Load resistance: 0 to 250 Ω				
External input (2-output type only, switchable with Output 2)	—————		<NPN output type> NPN non-contact input	<PNP output type> PNP non-contact input	
			<ul style="list-style-type: none"> Signal condition High: +8 V to +V DC or Open Low: 0 to +1.2 V DC (at 0.5 mA source current) Input impedance: 10 kΩ approx. 	<ul style="list-style-type: none"> Signal condition High: +4 V to +V DC (at 3 mA sink current) Low: 0 to +0.6 V DC or Open Input impedance: 10 kΩ approx. 	
Possible external input function	—————		Emission halt / Teaching (Full-auto, Limit, 2-point) / Logic operation setting / Copy lock / Display adjustment / Data bank load / Data bank save, selectable		
Sensitivity setting	2-point teaching / Limit teaching / Full-auto teaching / Manual adjustment				
Incident light intensity display range	H-SP / FAST / STD: 0 to 4,000, LONG: 0 to 8,000, U-LG / HYPR: 0 to 9,999				
Timer function	Incorporated with variable OFF-delay / ON-delay / One-shot / ON OFF-delay / ON-delay • One-shot timer, switchable either effective or ineffective		<Output 1> Incorporated with variable OFF-delay / ON-delay / One-shot / ON OFF-delay / ON-delay • One-shot timer, switchable either effective or ineffective		
			<Output 2> Incorporated with variable OFF-delay / ON-delay / One-shot timer, switchable either effective or ineffective		
Timer period	Timer range "ms": 0.5 ms approx., 1 to 9,999 ms approx., 1 ms approx., Timer range "sec.": 0.5 s approx., 1 to 32 s approx., 1 s approx., Timer range "1/10 ms": 0.05 ms approx., 0.1 to 999.9 ms approx., 0.1 ms approx., each output is set individually				
Light emitting amount selection function	Incorporated, 3 levels (each level 25 to 100 %) + Auto setting [1 level (25 to 100 %) when using H-SP mode]				
Interference prevention function	Incorporated (Note 5), selectable either automatic interference prevention or different frequency				
Various settings	Hysteresis setting / Shift amount setting / Emission power setting / Display turning setting / ECO setting / Data bank loading saving setting / Copying setting / Code setting / Reset setting / Logical calculation setting / Threshold tracking setting, etc.				
Protection	IP40 (IEC)				
Ambient temperature	-10 to +55 °C +14 to +131 °F [If 4 to 7 units are mounted in cascade: -10 to +50 °C +14 to +122 °F or if 8 to 16 units (cable type: 8 to 12 units) are mounted in cascade: -10 to +45 °C +14 to +113 °F] (No dew condensation or icing allowed), Storage: -20 to +70 °C -4 to +158 °F				
Emitting element (modulated)	Red LED (Peak emission wavelength: 643 nm 0.025 mil)				
Material	Enclosure, Case cover: Polycarbonate, Switch: TPEE				
Cable	—————				0.2 mm ² 6-core cabtyre cable, 2 m 6.562 ft long
Cable extension	—————				Extension up to total 100 m 328.084 ft is possible with 0.3 mm ² , or more, cable. (however, supply voltage 12 V DC)
Weight	Net weight: 15 g approx., Gross weight: 70 g approx.				Net weight: 60 g approx., Gross weight: 100 g approx.
Accessory	FX-MB1 (Amplifier protection seal): 1 set				

Notes: 1) Where measurement conditions have not been specified precisely, the conditions used were an ambient temperature of +23 °C +73.4 °F.

2) 50 mA max. if 5 or more standard types are connected together. (25 mA in case of 2-output type and cable type)

3) In case of using the quick-connection cable (cable length 5 m 16.404 ft) (optional).

4) If display adjustment was conducted, it is not in this range.

5) Number of sensor heads which is possible to be mounted closely in auto interference prevention function depends on response time as shown in table below. Number of sensor heads which is possible to be mounted closely in different frequency Interference prevention function is up to 3 units.

• Number of sensor heads mountable closely (Unit: set)

Response time	H-SP	FAST	STD	LONG	U-LG	HYPR
IP-1	0	2	4	8	8	12

New product
introduction
Tough
Fiber

Fiber
Selection
Guide

Model

Choose
by shape/
application

How to read
Model No

Earlier models
comparison
table

Fibers

Super
Quality

Threaded
Type

Square Head
Type

Cylindrical
Type

Sleeve

Flat
Type

Small
Spot

Narrow
Beam

Wide
Beam

Convergent
Reflective
Type

Retroreflective
Type

Chemical / Oil-
resistant

Heat-
resistant

Vacuum-
resistant

Liquid Leak /
Liquid Detection

Fiber
Options

Semi-custom
fibers

Fiber
Dimensions

Thru-beam
Type

Retroreflective
Type

Reflective
Type

Others

Amplifiers

FX-500
series

FX-100
series

INDEX

I/O CIRCUIT AND WIRING DIAGRAMS

FX-501

NPN output type

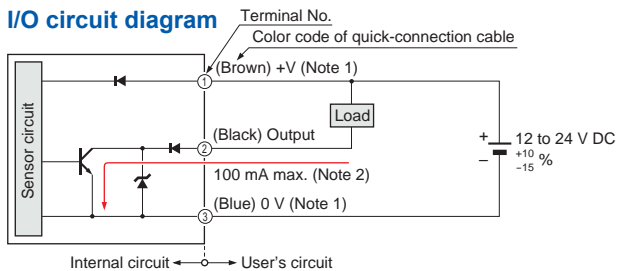

Notes: 1) The quick-connection sub cable does not have +V (brown) and 0 V (blue). The power is supplied from the connector of the main cable.
2) 50 mA max., if five amplifiers or more, are connected together.

Wiring diagram

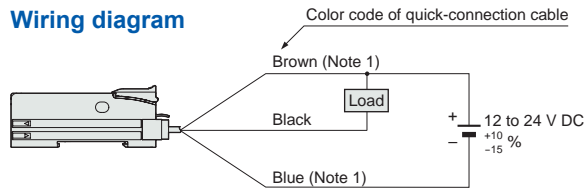

Note: The quick-connection sub cable does not have a brown and a blue lead wire.

Terminal arrangement diagram

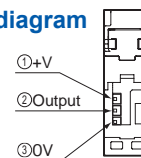

FX-501P

PNP output type

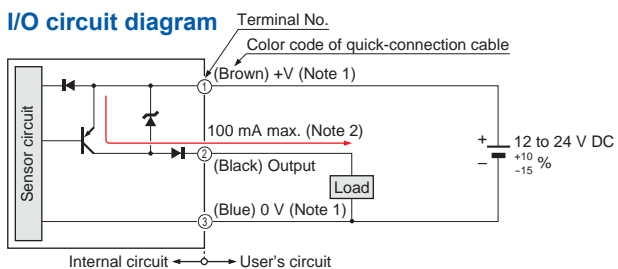

Notes: 1) The quick-connection sub cable does not have +V (brown) and 0 V (blue). The power is supplied from the connector of the main cable.
2) 50 mA max., if five amplifiers or more, are connected together.

Wiring diagram

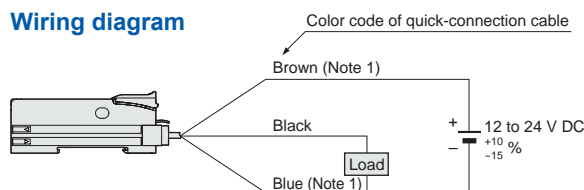

Note: The quick-connection sub cable does not have a brown and a blue lead wire.

Terminal arrangement diagram

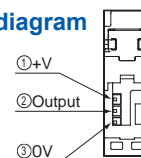

FX-502

NPN output type

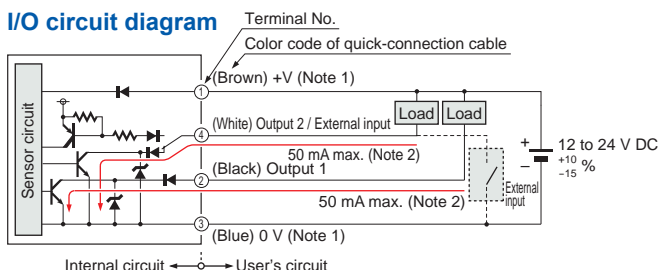

Notes: 1) The quick-connection sub cable does not have +V (brown) and 0 V (blue). The power is supplied from the connector of the main cable.
2) 25 mA max., if five amplifiers or more, are connected together.

Wiring diagram

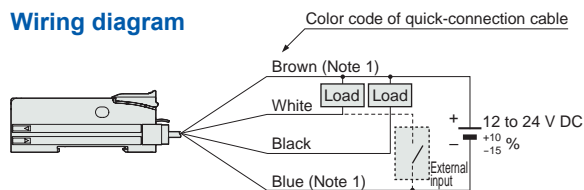

Note: The quick-connection sub cable does not have a brown and a blue lead wire.

Terminal arrangement diagram

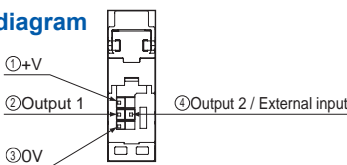

FX-502P

PNP output type

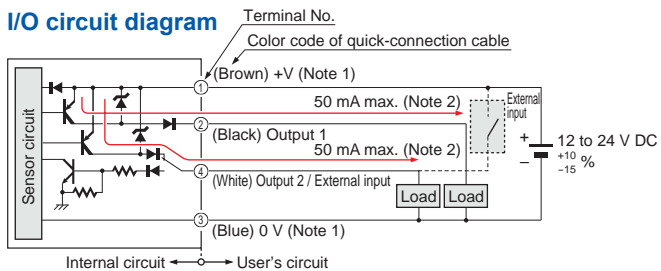

Notes: 1) The quick-connection sub cable does not have +V (brown) and 0 V (blue). The power is supplied from the connector of the main cable.
2) 25 mA max., if five amplifiers or more, are connected together.

Wiring diagram

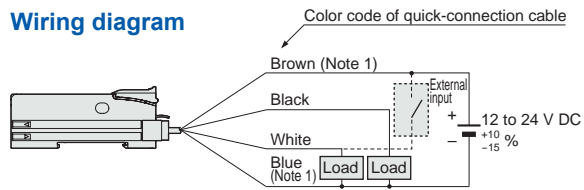

Note: The quick-connection sub cable does not have a brown and a blue lead wire.

Terminal arrangement diagram

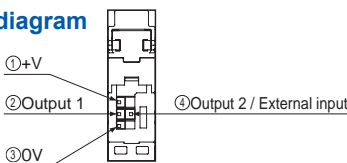

New product introduction
Tough Fiber
Fiber Selection Guide
Model
Choose by shape/application
How to read Model No.
Earlier models comparison table

Fibers
Super Quality
Threaded Type
Square Head Type
Cylindrical Type
Sleeve
Flat Type
Small Spot
Narrow Beam
Wide Beam
Convergent Reflective Type
Retroreflective Type
Chemical / Oil-resistant
Heat-resistant
Vacuum-resistant
Liquid Leak / Liquid Detection

Fiber Options

Semi-custom fibers

Fiber Dimensions
Thru-beam Type
Retroreflective Type
Reflective Type
Others

Amplifiers
FX-500 series
FX-100 series

INDEX

I/O CIRCUIT AND WIRING DIAGRAMS

FX-505-C2

NPN output type

I/O circuit diagram

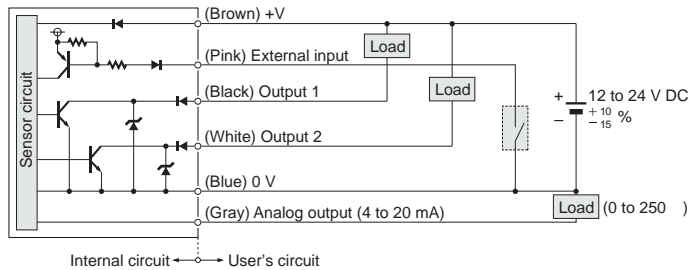

Wiring diagram

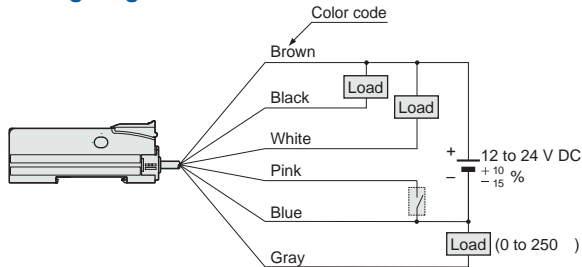

FX-505P-C2

PNP output type

I/O circuit diagram

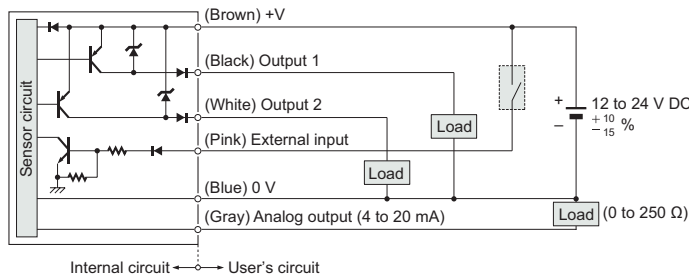

Wiring diagram

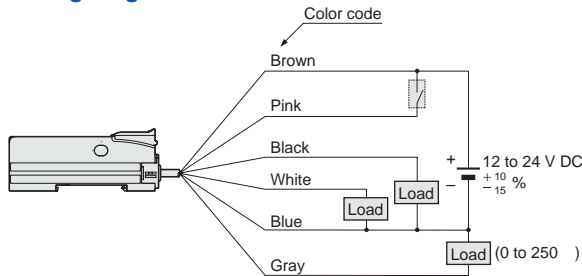

New product introduction
Tough Fiber

Fiber Selection Guide
Model
Choose by shape/application
How to read Model No
Earlier models comparison table

Fibers
Super Quality
Threaded Type
Square Head Type
Cylindrical Type
Sleeve
Flat Type
Small Spot
Narrow Beam
Wide Beam
Convergent Reflective Type
Retroreflective Type
Chemical / Oil-resistant
Heat-resistant
Vacuum-resistant
Liquid Leak / Liquid Detection

Fiber Options

Semi-custom fibers

Fiber Dimensions
Thru-beam Type
Retroreflective Type
Reflective Type
Others

Amplifiers
FX-500 series
FX-100 series

INDEX

SENSING CHARACTERISTICS (TYPICAL)

Thru-beam type Parallel deviation Sensing characteristics are listed in the alphabetic order of the Model No.

FT-140 Thru-beam type **FT-30** Thru-beam type **FT-31** Thru-beam type **FT-31S** Thru-beam type

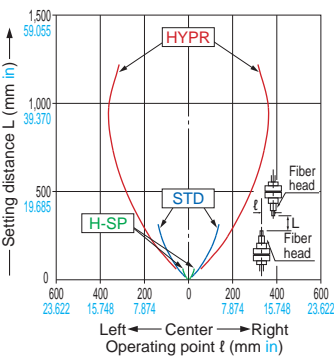
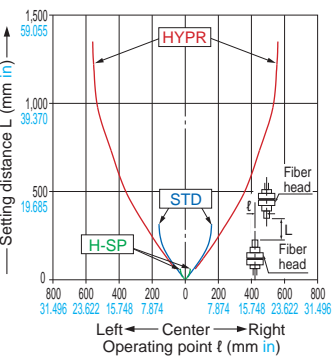
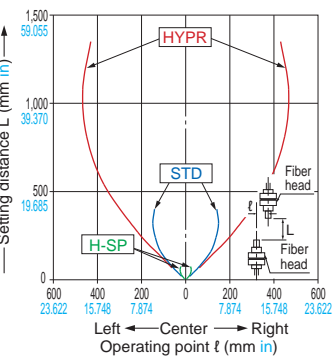
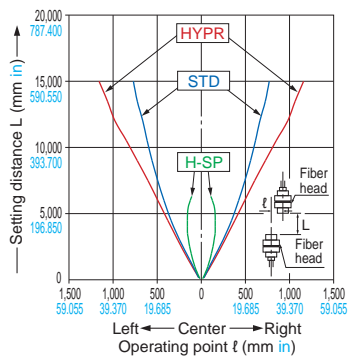

FT-31W Thru-beam type

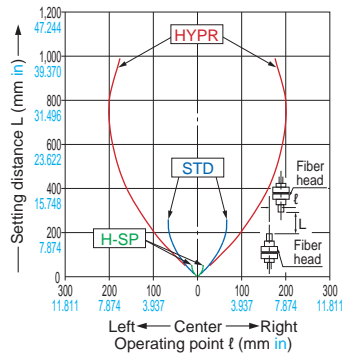

FT-40 Thru-beam type

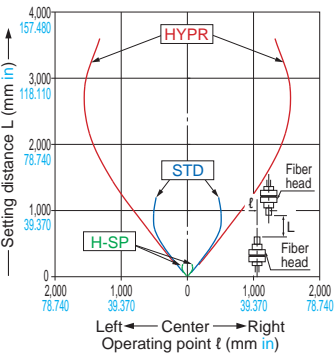

FT-42 Thru-beam type

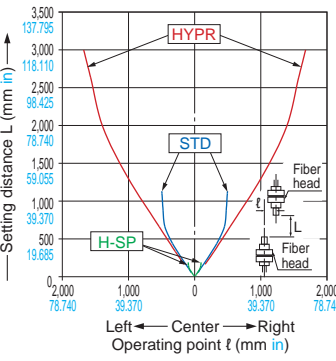

FT-42S Thru-beam type

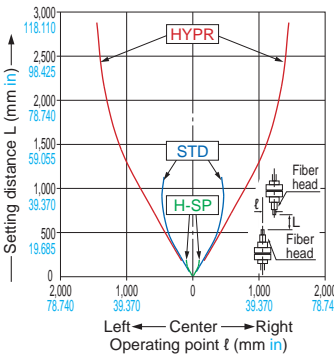

FT-42W Thru-beam type

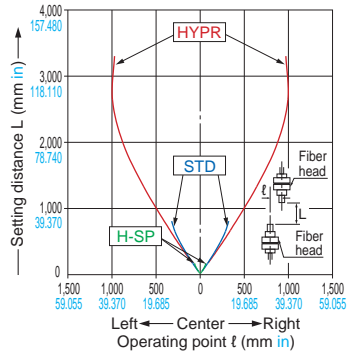

FT-43 Thru-beam type

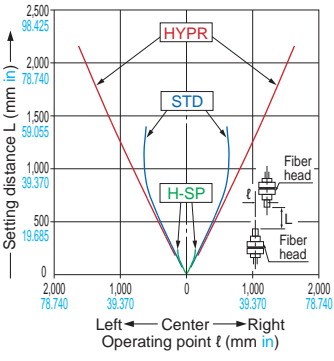

FT-45X Thru-beam type

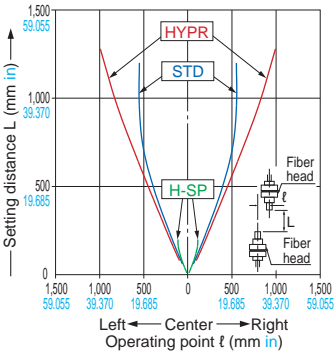

FT-A11 Thru-beam type

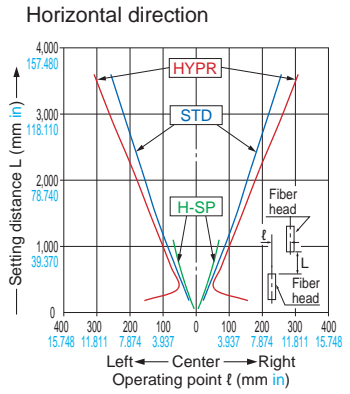

FT-A11W Thru-beam type

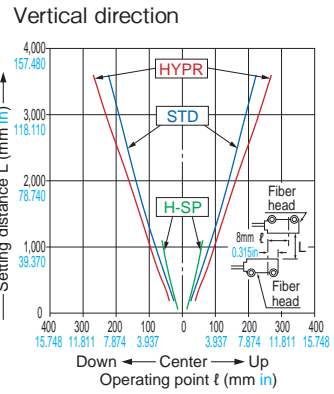

FT-A11V Thru-beam type

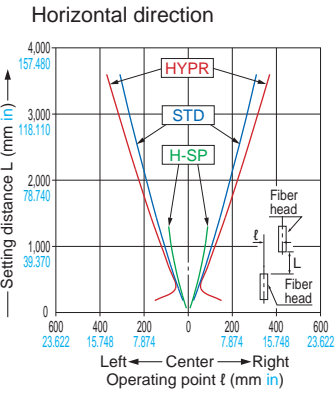

FT-A11W Thru-beam type

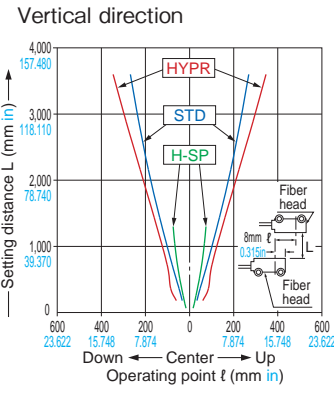

New product introduction
Tough Fiber

Fiber Selection Guide
Model
Choose by shape/application
How to read Model No.
Earlier models comparison table

Fibers
Super Quality
Threaded Type
Square Head Type
Cylindrical Type
Sleeve
Flat Type
Small Spot
Narrow Beam
Wide Beam
Convergent Reflective Type
Retroreflective Type
Chemical / Oil-resistant
Heat-resistant
Vacuum-resistant
Liquid Leak / Liquid Detection

Fiber Options
Semi-custom fibers

Fiber Dimensions
Thru-beam Type
Retroreflective Type
Reflective Type
Others

Amplifiers
FX-500 series
FX-100 series

INDEX

SENSING CHARACTERISTICS (TYPICAL)

Thru-beam type Parallel deviation Sensing characteristics are listed in the alphabetic order of the Model No. (Models with same sensing characteristics are grouped together.)

FT-A32

Thru-beam type

Horizontal direction

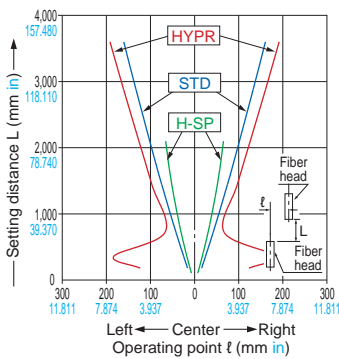

Vertical direction

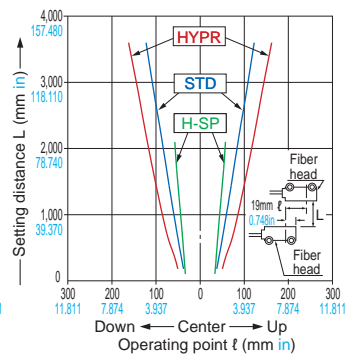

FT-A32W

Thru-beam type

Horizontal direction

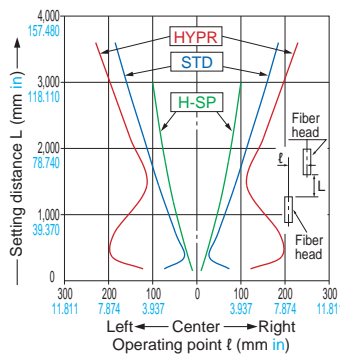

Vertical direction

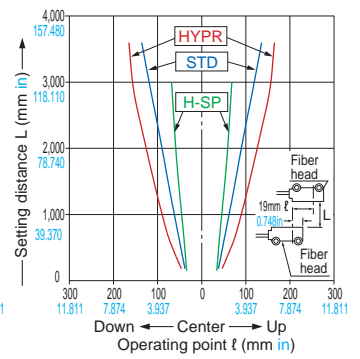

FT-AL05

Thru-beam type

Horizontal direction

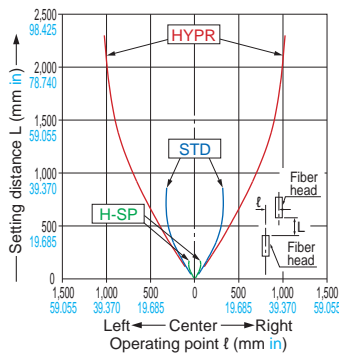

Vertical direction

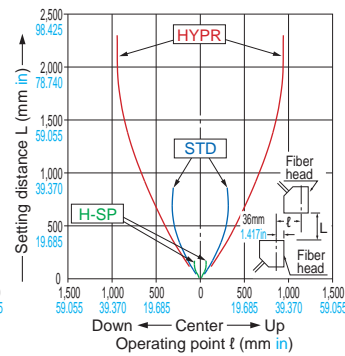

FT-E13

Thru-beam type

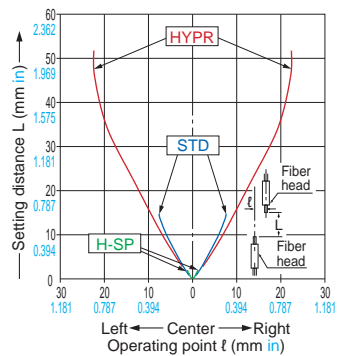

FT-E23

Thru-beam type

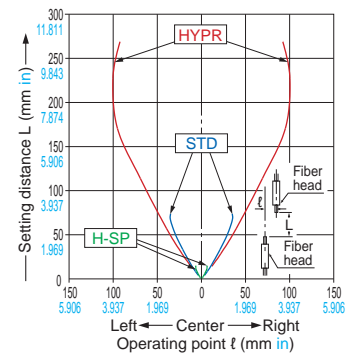

FT-H13-FM2

Thru-beam type

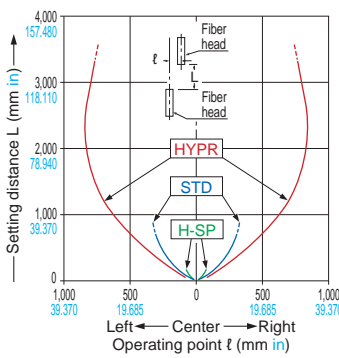

FT-H20-J20-S FT-H20-J30-S FT-H20-J50-S

Thru-beam type

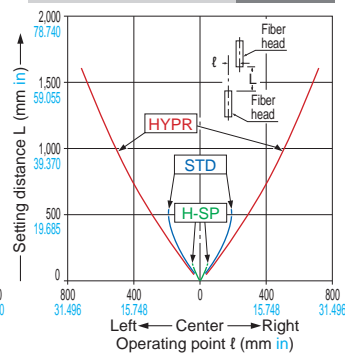

FT-H20-M1

Thru-beam type

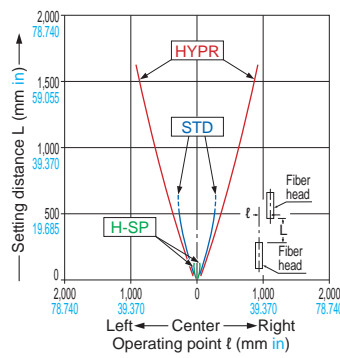

FT-H20-VJ50-S FT-H20-VJ80-S

Thru-beam type

Horizontal direction

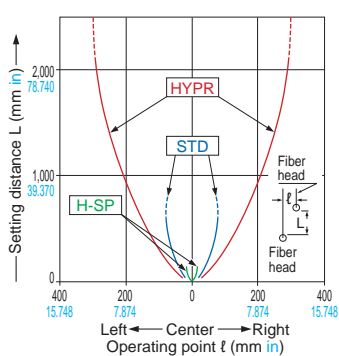

Vertical direction

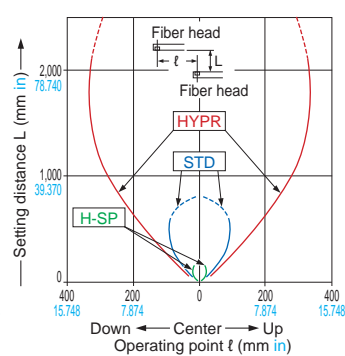

FT-H20W-M1

Thru-beam type

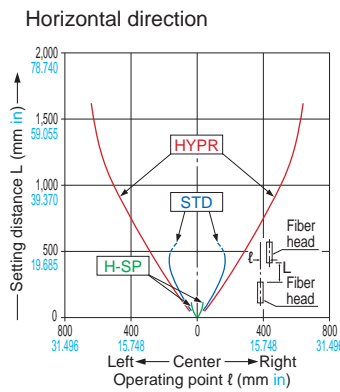

FT-H30-M1V-S

Thru-beam type

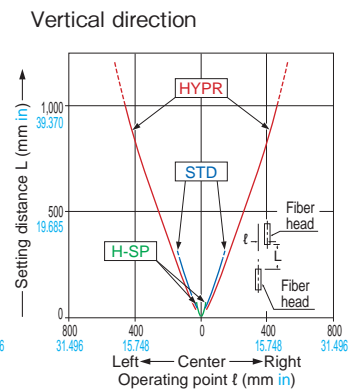

New product introduction
Tough Fiber

Fiber Selection Guide
Model
Choose by shape/application
How to read Model No.
Earlier models comparison table

Fibers
Super Quality
Threaded Type
Square Head Type
Cylindrical Type
Sleeve
Flat Type
Small Spot
Narrow Beam
Wide Beam
Convergent Reflective Type
Retroreflective Type
Chemical / Oil-resistant
Heat-resistant
Vacuum-resistant

Fiber Options
Semi-custom fibers

Fiber Dimensions
Thru-beam Type
Retroreflective Type
Reflective Type

Others

Amplifiers
FX-500 series
FX-100 series

INDEX

SENSING CHARACTERISTICS (TYPICAL)

Thru-beam type Parallel deviation Sensing characteristics are listed in the alphabetic order of the Model No. (Models with same sensing characteristics are grouped together.)

FT-H35-M2 Thru-beam type
FT-H35-M2S6

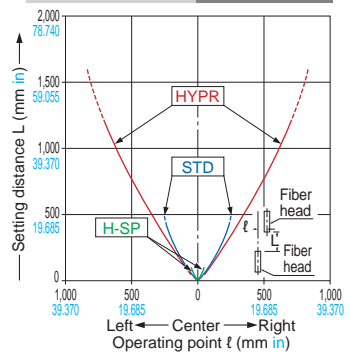

FT-HL80Y Thru-beam type

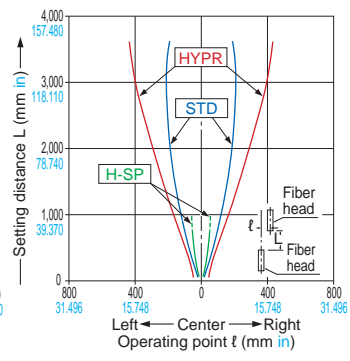

FT-KS40 Thru-beam type

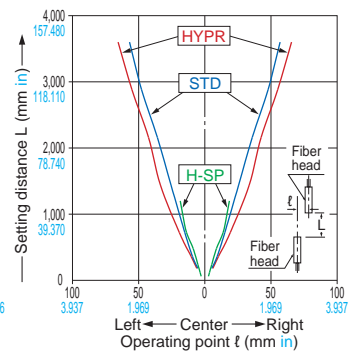

FT-KV26 Thru-beam type

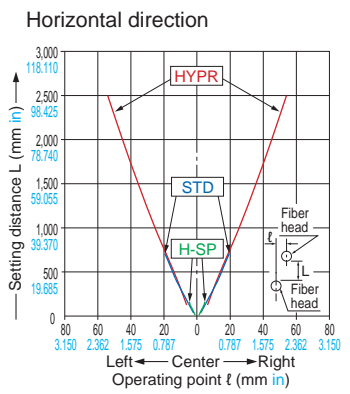

FT-KV40 Thru-beam type

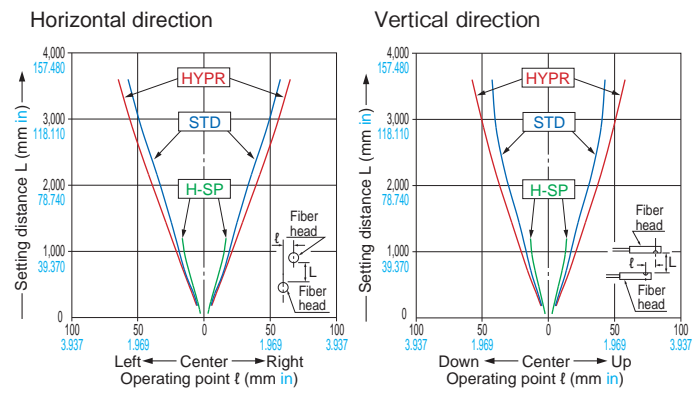

FT-KV40W Thru-beam type

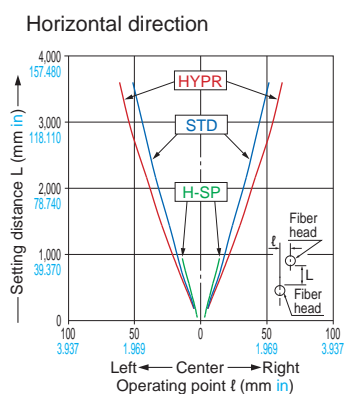

FT-L80Y Thru-beam type

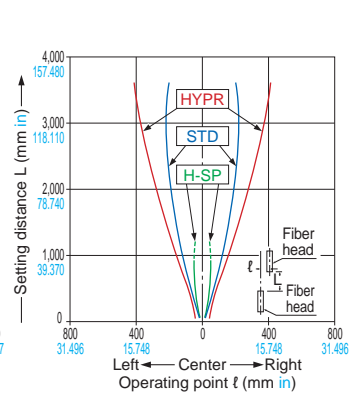

FT-R40 Thru-beam type

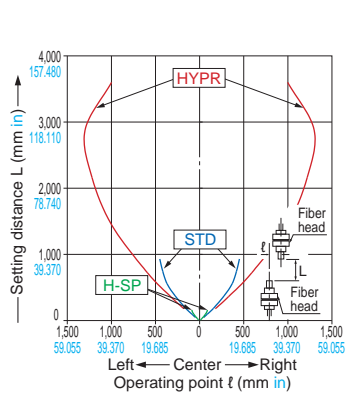

FT-R41W Thru-beam type

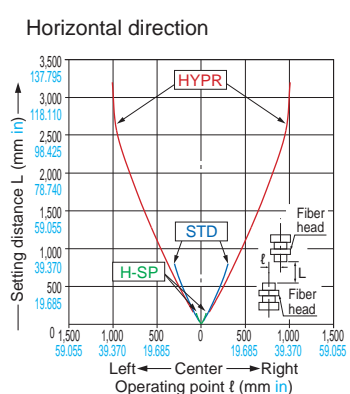

FT-R42W Thru-beam type

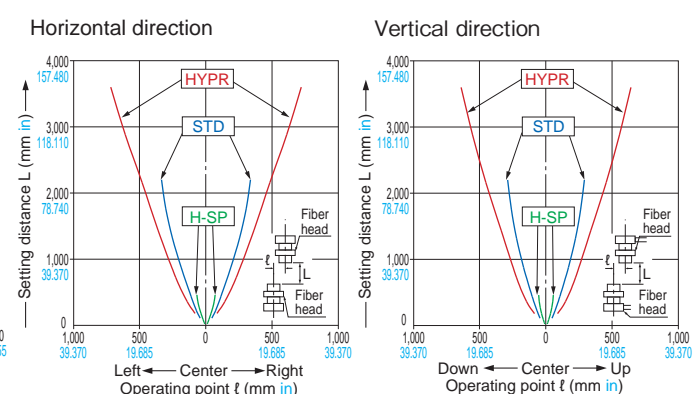

New product introduction
Tough Fiber
Fiber Selection Guide
Model
Choose by shape/application
How to read Model No.
Earlier models comparison table

Fibers
Super Quality
Threaded Type
Square Head Type
Cylindrical Type
Sleeve
Flat Type
Small Spot
Narrow Beam
Wide Beam
Convergent Reflective Type
Retroreflective Type
Chemical / Oil-resistant
Heat-resistant
Vacuum-resistant
Liquid Leak / Liquid Detection

Fiber Options

Semi-custom fibers

Fiber Dimensions
Thru-beam Type
Retroreflective Type
Reflective Type
Others

Amplifiers
FX-500 series
FX-100 series

INDEX

SENSING CHARACTERISTICS (TYPICAL)

Thru-beam type Parallel deviation Sensing characteristics are listed in the alphabetic order of the Model No.

FT-R44Y Thru-beam type

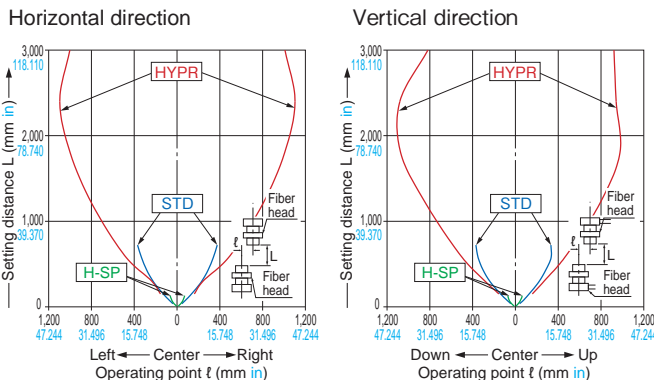

FT-R60Y Thru-beam type

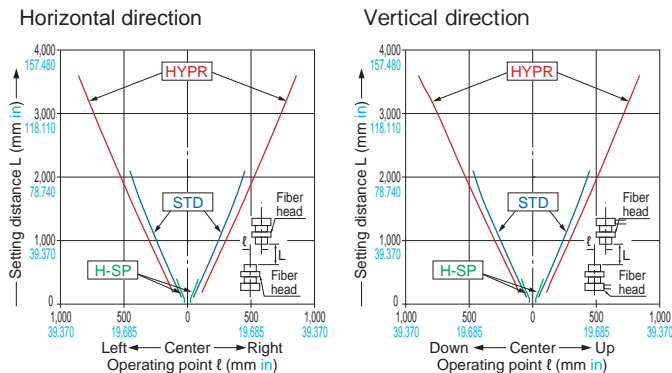

FT-S11 Thru-beam type

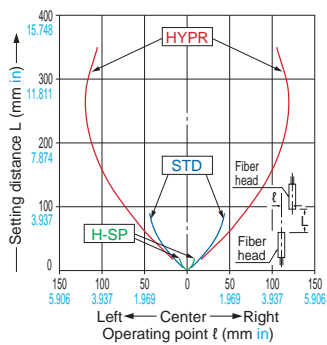

FT-S20 Thru-beam type

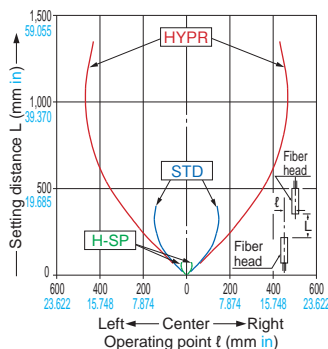

FT-S21 Thru-beam type

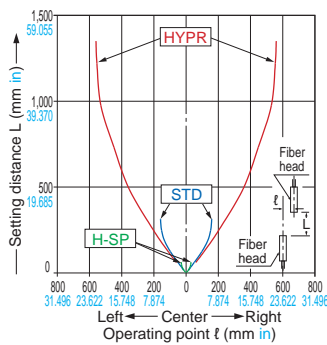

FT-S21W Thru-beam type

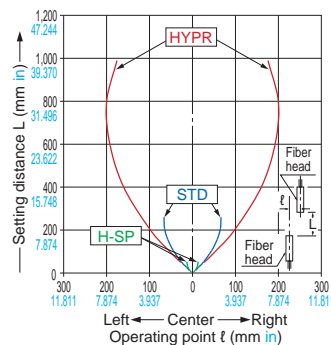

FT-S30 Thru-beam type

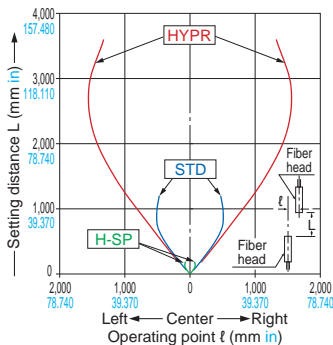

FT-S31W Thru-beam type

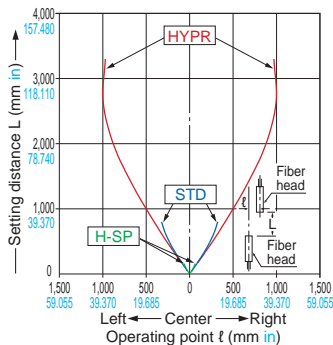

FT-S32 Thru-beam type

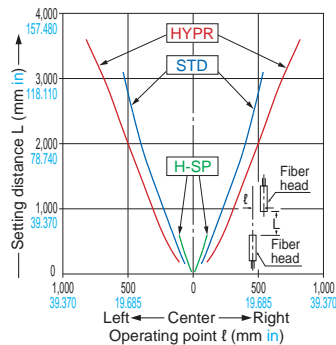

FT-V23 Thru-beam type

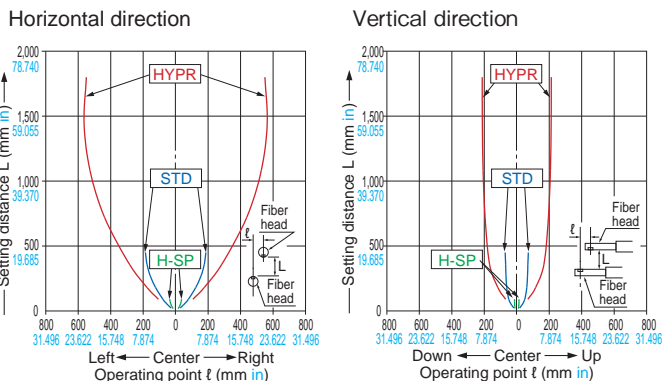

FT-V24W Thru-beam type

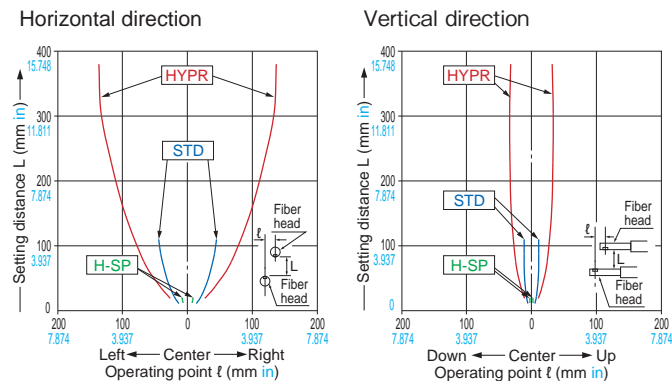

- New product introduction
- Tough Fiber
- Fiber Selection Guide
- Model
- Choose by shape/application
- How to read Model No
- Earlier models comparison table
- Fibers
- Super Quality
- Threaded Type
- Square Head Type
- Cylindrical Type
- Sleeve
- Flat Type
- Small Spot
- Narrow Beam
- Wide Beam
- Convergent Reflective Type
- Retroreflective Type
- Chemical / Oil-resistant
- Heat-resistant
- Vacuum-resistant
- Liquid Leak / Liquid Detection
- Fiber Options
- Semi-custom fibers
- Fiber Dimensions
- Thru-beam Type
- Retroreflective Type
- Reflective Type
- Others
- Amplifiers
- FX-500 series
- FX-100 series
- INDEX

SENSING CHARACTERISTICS (TYPICAL)

Thru-beam type Parallel deviation Sensing characteristics are listed in the alphabetic order of the Model No.

FT-V25

Thru-beam type

Horizontal direction

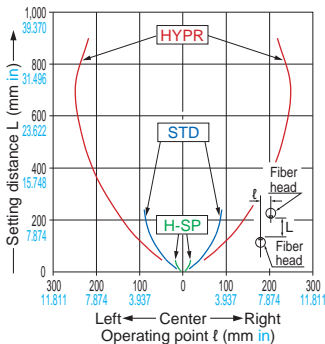

Vertical direction

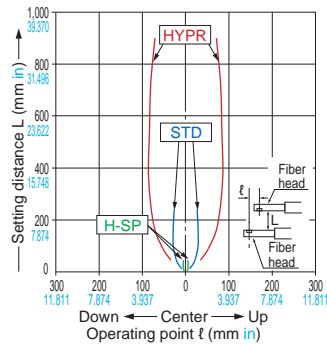

FT-V30

Thru-beam type

Horizontal direction

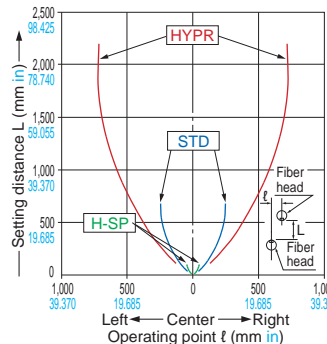

Vertical direction

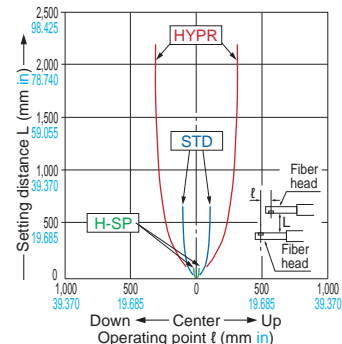

FT-V40

Thru-beam type

Horizontal direction

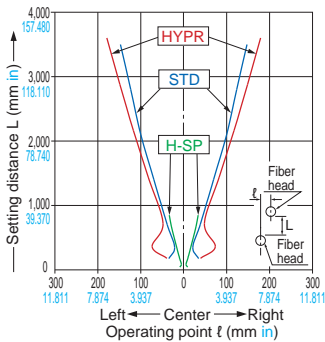

Vertical direction

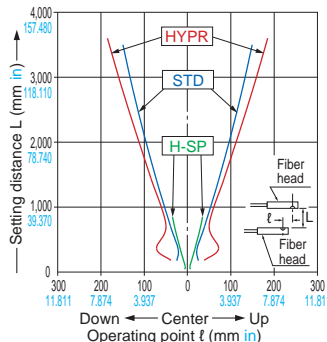

FT-V80Y

Thru-beam type

Horizontal direction

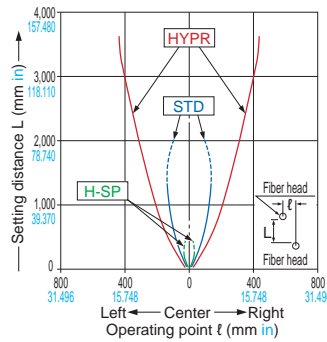

Vertical direction

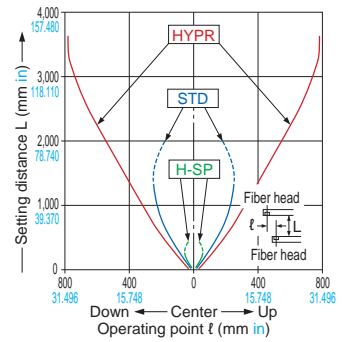

FT-Z20HBW

Thru-beam type

Horizontal direction

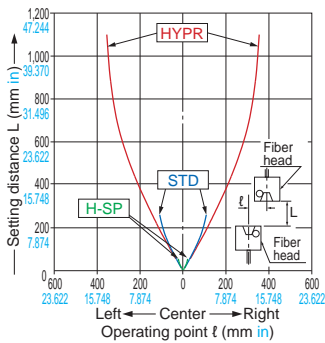

FT-Z20W

Thru-beam type

Horizontal direction

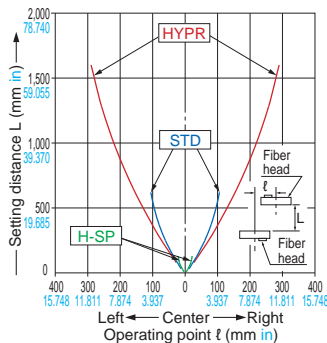

Vertical direction

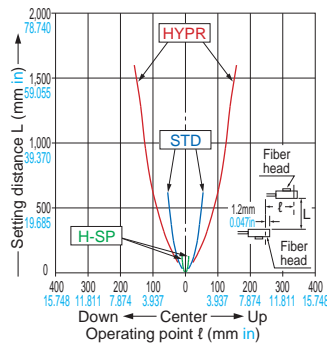

FT-Z30

Thru-beam type

Horizontal direction

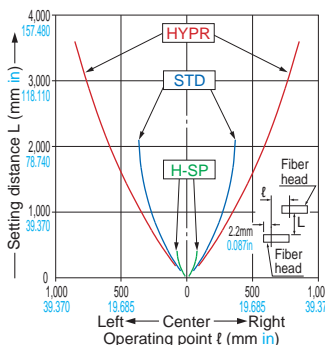

Vertical direction

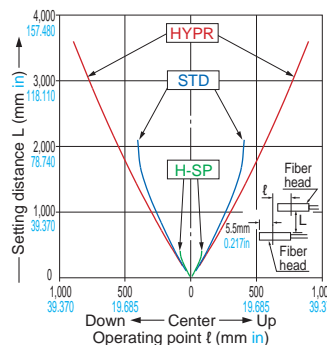

FT-Z30E

Thru-beam type

Horizontal direction

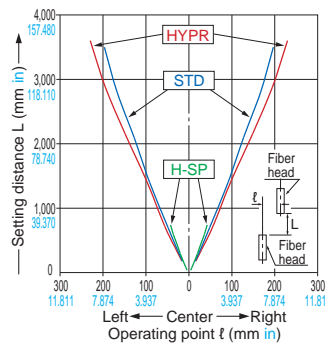

Vertical direction

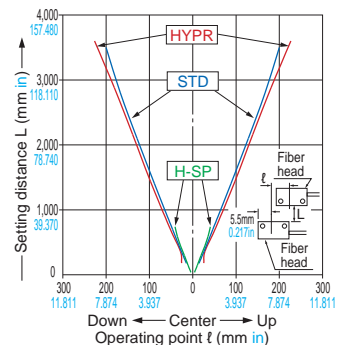

- New product introduction
- Tough Fiber
- Fiber Selection Guide
- Model
- Choose by shape/application
- How to read Model No.
- Earlier models comparison table
- Fibers
- Super Quality
- Threaded Type
- Square Head Type
- Cylindrical Type
- Sleeve
- Flat Type
- Small Spot
- Narrow Beam
- Wide Beam
- Convergent Reflective Type
- Retroreflective Type
- Chemical / Oil-resistant
- Heat-resistant
- Vacuum-resistant
- Liquid Leak / Liquid Detection
- Fiber Options
- Semi-custom fibers
- Fiber Dimensions
- Thru-beam Type
- Retroreflective Type
- Reflective Type
- Others
- Amplifiers
- FX-500 series
- FX-100 series
- INDEX

SENSING CHARACTERISTICS (TYPICAL)

Thru-beam type Parallel deviation Sensing characteristics are listed in the alphabetic order of the Model No.

FT-Z30EW Thru-beam type

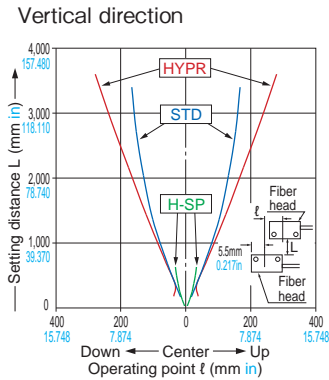
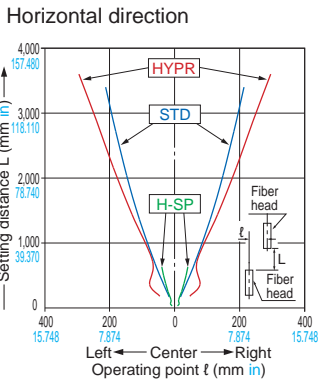

FT-Z30H Thru-beam type

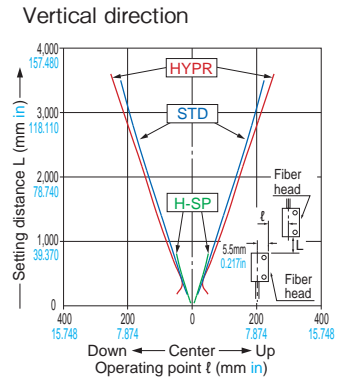
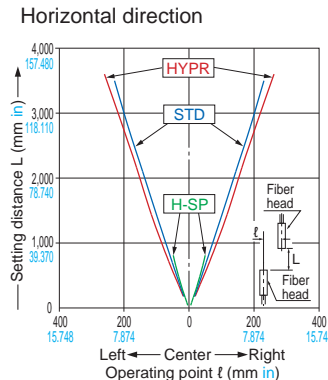

FT-Z30HW Thru-beam type

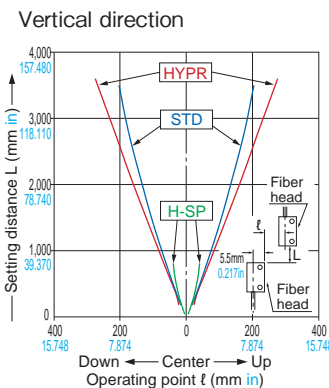
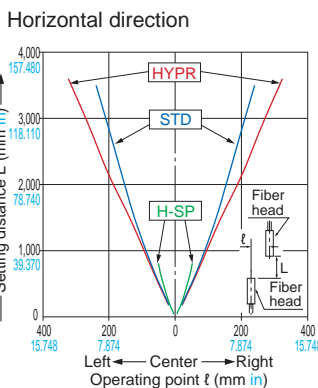

FT-Z30W Thru-beam type

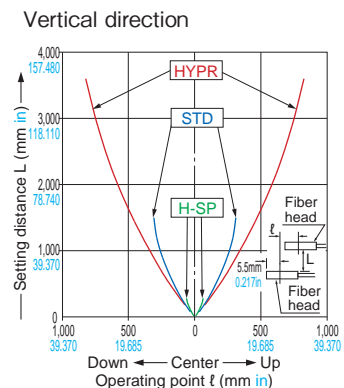
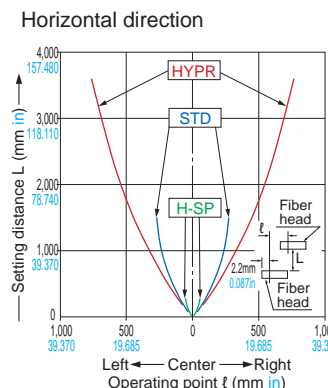

FT-Z40W Thru-beam type

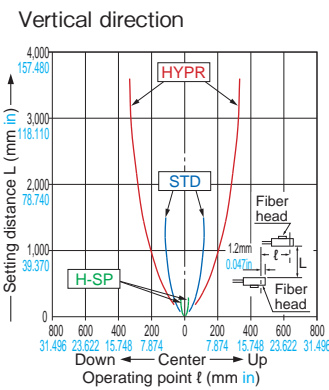
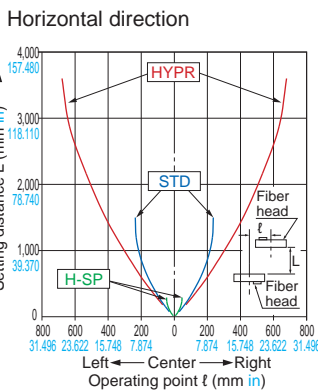

FT-Z40HBW Thru-beam type

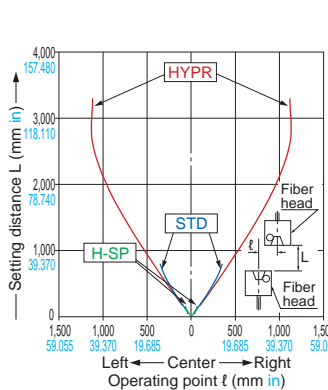

FT-Z802Y Thru-beam type

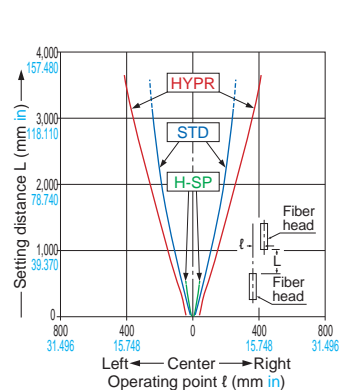
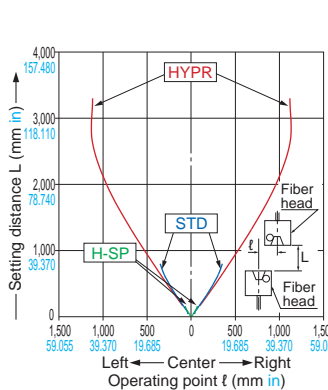

Retroreflective type Parallel deviation Sensing characteristics are listed in the alphabetic order of the Model No.

FR-KZ22E Retroreflective type

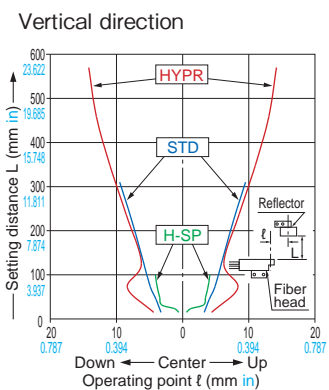
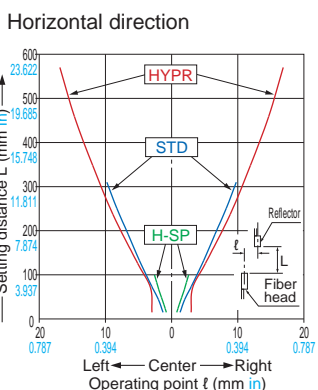

FR-KZ50E Retroreflective type

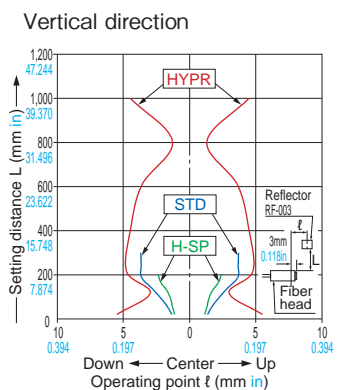
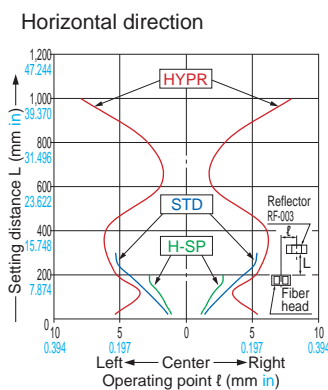

New product introduction
Tough Fiber
Fiber Selection Guide
Model
Choose by shape/application
How to read Model No
Earlier models comparison table

Fibers
Super Quality
Threaded Type
Square Head Type
Cylindrical Type
Sleeve
Flat Type
Small Spot
Narrow Beam
Wide Beam
Convergent Reflective Type
Retroreflective Type
Chemical / Oil-resistant
Heat-resistant
Vacuum-resistant
Liquid Leak / Liquid Detection

Fiber Options
Semi-custom fibers
Fiber Dimensions
Thru-beam Type
Retroreflective Type
Reflective Type
Others

Amplifiers
FX-500 series
FX-100 series
INDEX

SENSING CHARACTERISTICS (TYPICAL)

Retroreflective type Parallel deviation Sensing characteristics are listed in the alphabetic order of the Model No.

FR-KZ50H Retroreflective type

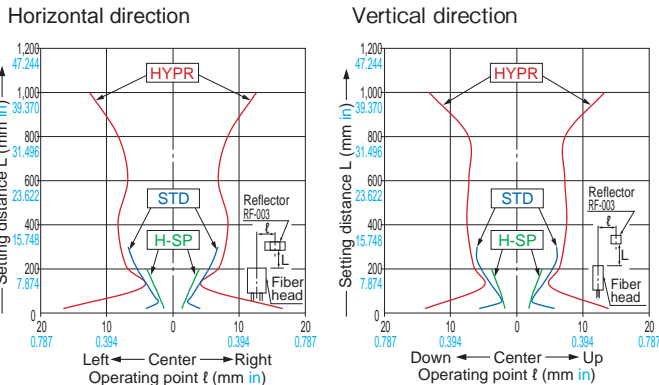

FR-Z50HW Retroreflective type

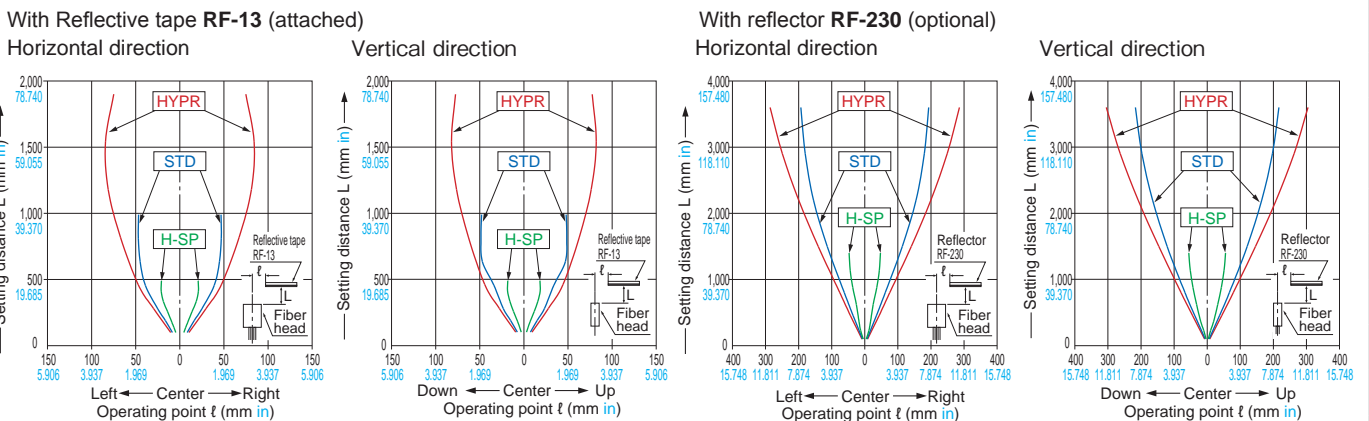

Reflective type Sensing field Sensing characteristics are listed in the alphabetic order of the Model No.

FD-30 Reflective type

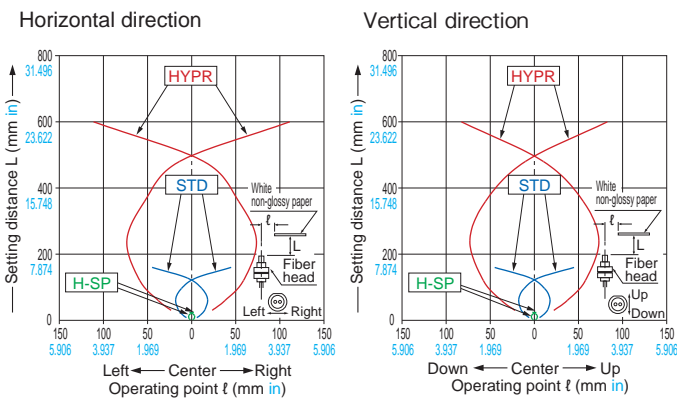

FD-31 Reflective type

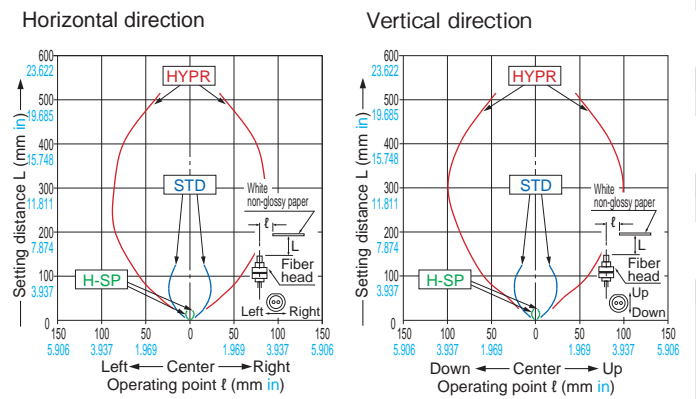

FD-31W Reflective type

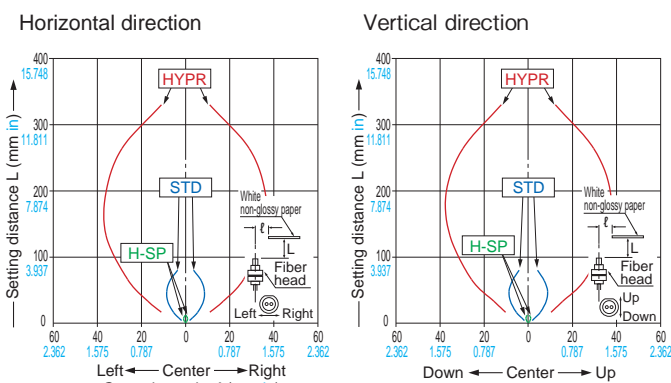

FD-32G Reflective type

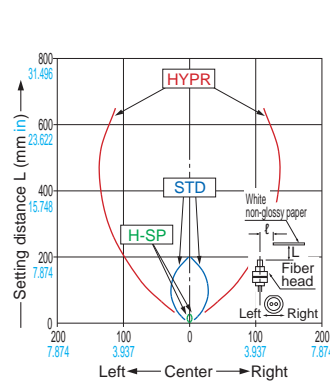

New product introduction
Tough Fiber
Fiber Selection Guide
Model
Choose by shape/application
How to read Model No.
Earlier models comparison table

Fibers
Super Quality
Threaded Type
Square Head Type
Cylindrical Type
Sleeve
Flat Type
Small Spot
Narrow Beam
Wide Beam
Convergent Reflective Type
Retroreflective Type
Chemical / Oil-resistant
Heat-resistant
Vacuum-resistant
Liquid Leak / Liquid Detection

Fiber Options
Semi-custom fibers
Fiber Dimensions
Thru-beam Type
Retroreflective Type
Reflective Type
Others

Amplifiers
FX-500 series
FX-100 series

INDEX

SENSING CHARACTERISTICS (TYPICAL)

Reflective type Sensing field Sensing characteristics are listed in the alphabetic order of the Model No.

FD-32GX Reflective type

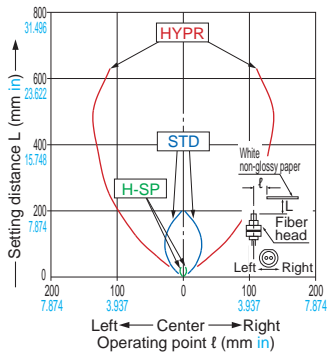

FD-40 Reflective type

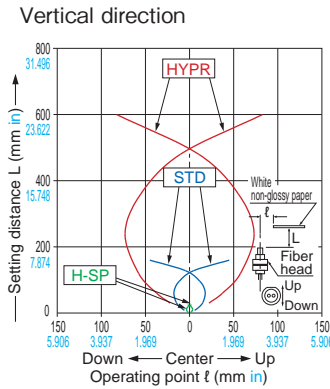
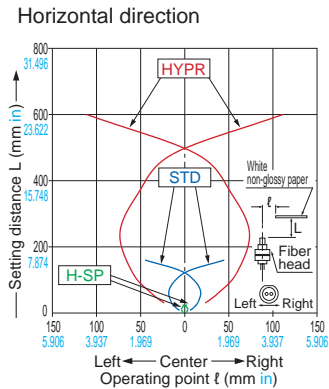

FD-41 Reflective type

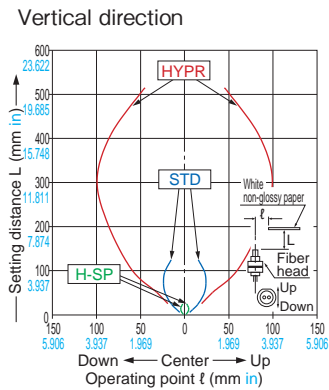
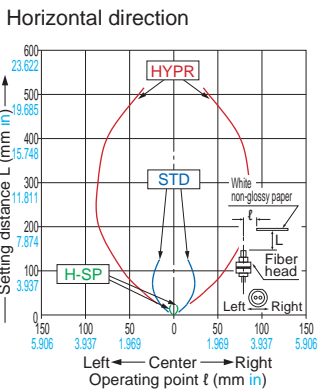

FD-41S Reflective type

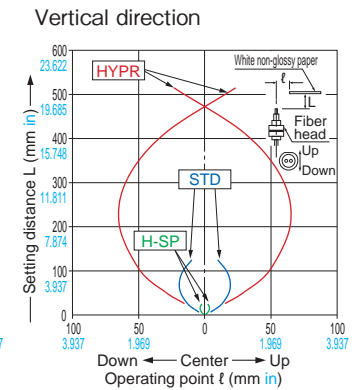
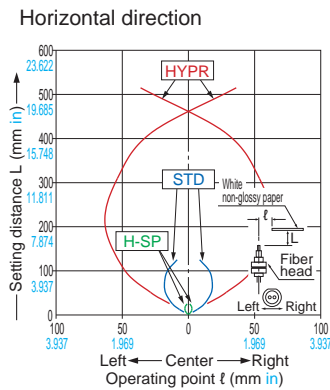

FD-41SW Reflective type

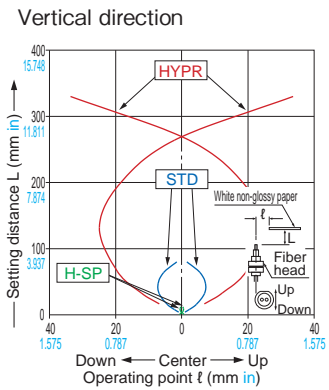
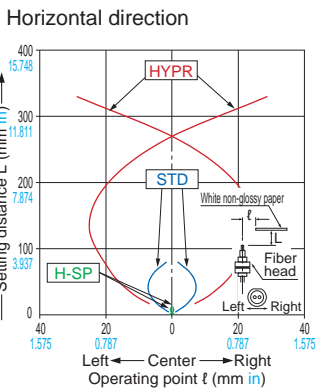

FD-41W Reflective type

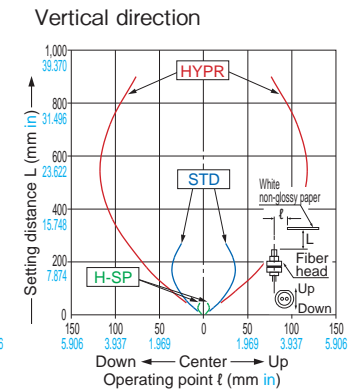
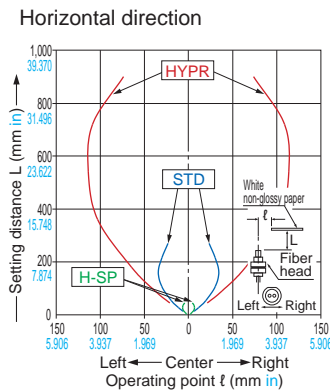

FD-42G Reflective type

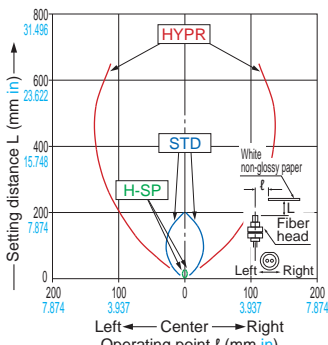

FD-42GW Reflective type

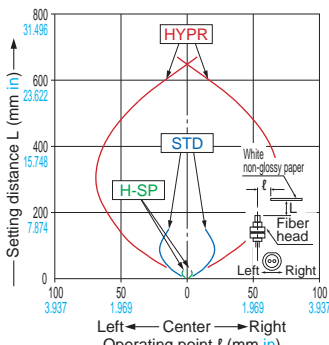

FD-60 Reflective type

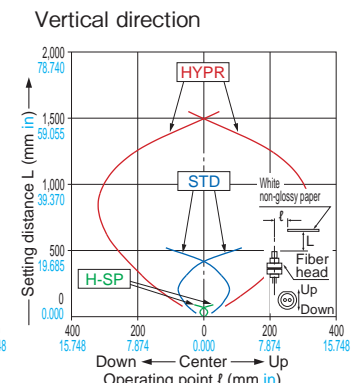
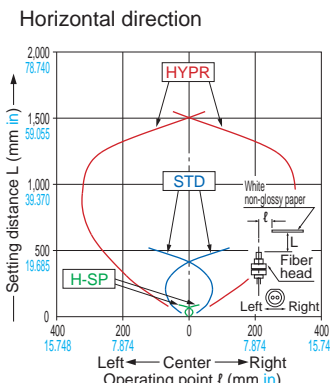

- Fiber Selection Guide
- Model
- Choose by shape/application
- How to read Model No
- Earlier models comparison table
- Fibers
- Super Quality
- Threaded Type
- Square Head Type
- Cylindrical Type
- Sleeve
- Flat Type
- Small Spot
- Narrow Beam
- Wide Beam
- Convergent Reflective Type
- Retroreflective Type
- Chemical / Oil-resistant
- Heat-resistant
- Vacuum-resistant
- Liquid Leak / Liquid Detection
- Fiber Options
- Semi-custom fibers
- Fiber Dimensions
- Thru-beam Type
- Retroreflective Type
- Reflective Type
- Others
- Amplifiers
- FX-500 series
- FX-100 series
- INDEX

SENSING CHARACTERISTICS (TYPICAL)

Reflective type Sensing field Sensing characteristics are listed in the alphabetic order of the Model No.

FD-61

Reflective type

Horizontal direction

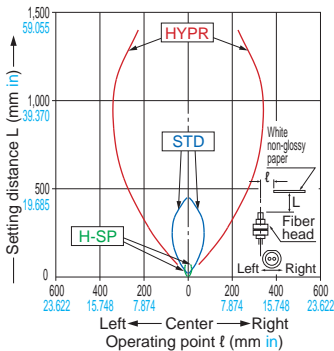

Vertical direction

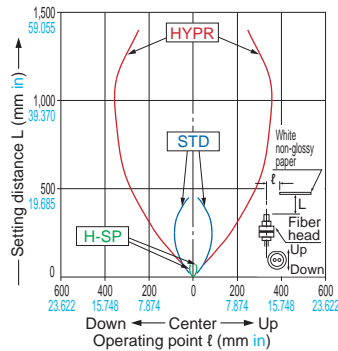

FD-61G

Reflective type

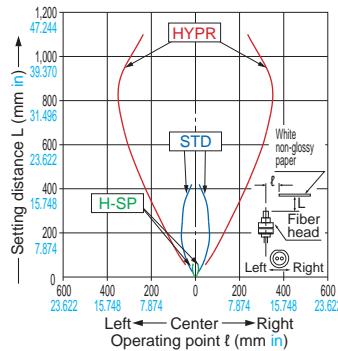

FD-61S

Reflective type

Horizontal direction

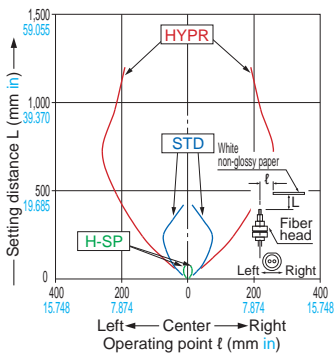

Vertical direction

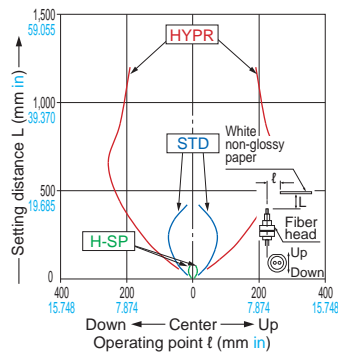

FD-61W

Reflective type

Horizontal direction

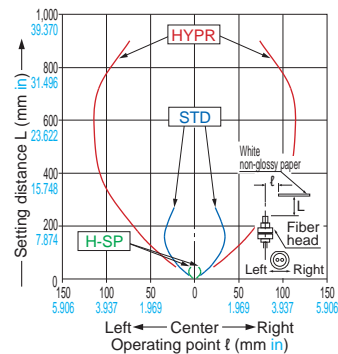

Vertical direction

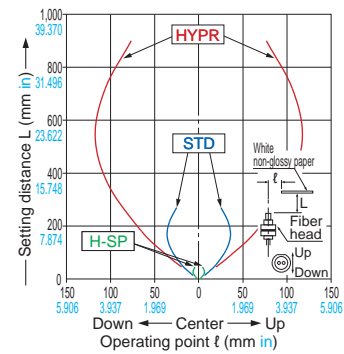

FD-62

Reflective type

Horizontal direction

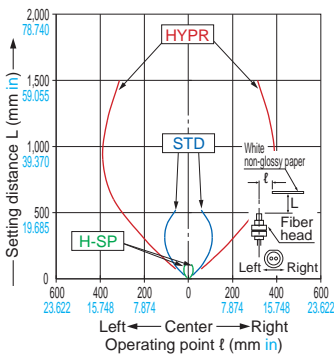

Vertical direction

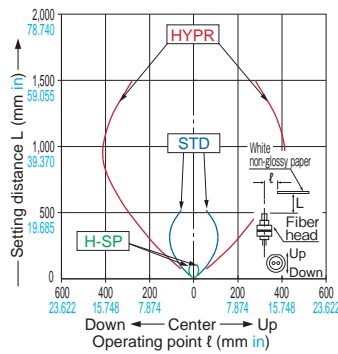

FD-64X

Reflective type

Horizontal direction

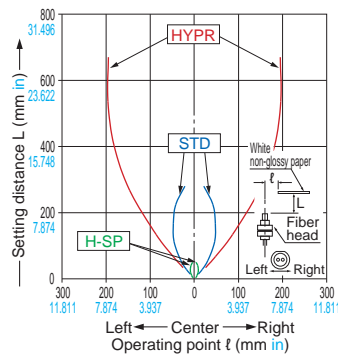

Vertical direction

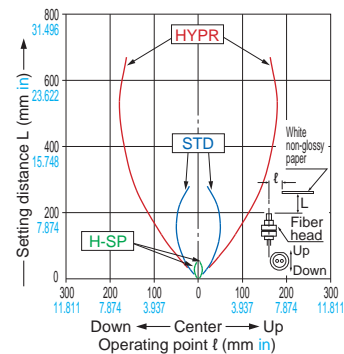

FD-A16

Reflective type

Horizontal direction

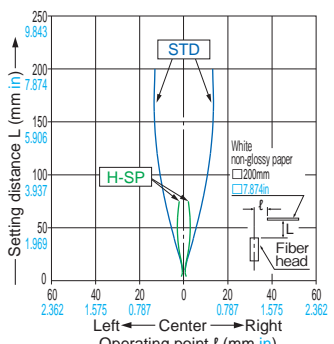

Vertical direction

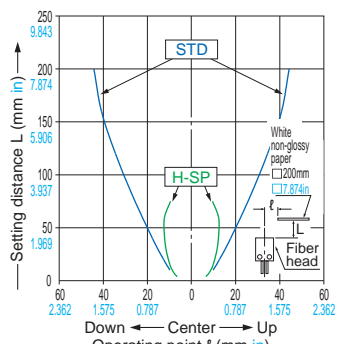

FD-AL11

Reflective type

Horizontal direction

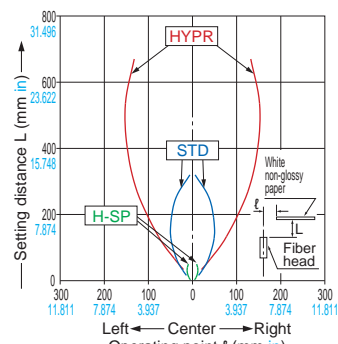

Vertical direction

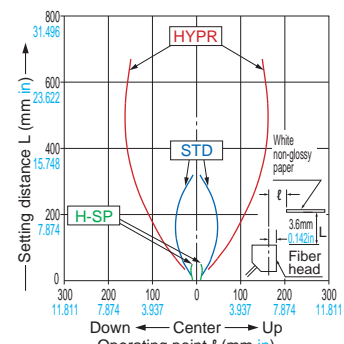

New product introduction
Tough Fiber

Fiber Selection Guide
Model
Choose by shape/application
How to read Model No.
Earlier models comparison table

Fibers
Super Quality
Threaded Type
Square Head Type
Cylindrical Type
Sleeve
Flat Type
Small Spot
Narrow Beam
Wide Beam
Convergent Reflective Type
Retroreflective Type
Chemical / Oil-resistant
Heat-resistant
Vacuum-resistant
Liquid Leak / Liquid Detection

Fiber Options

Semi-custom fibers

Fiber Dimensions

Thru-beam Type

Retroreflective Type

Reflective Type

Others

Amplifiers
FX-500 series
FX-100 series

INDEX

SENSING CHARACTERISTICS (TYPICAL)

Reflective type Sensing field Sensing characteristics are listed in the alphabetic order of the Model No.

FD-E13 Reflective type

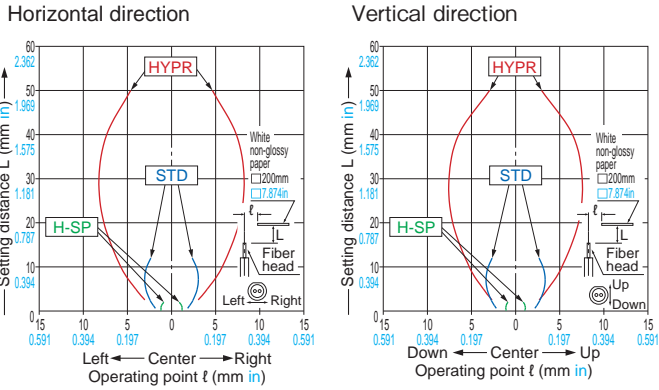

FD-E23 Reflective type

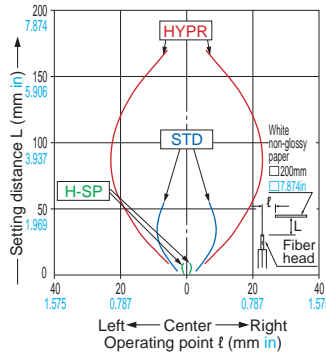

FD-EG30 Reflective type

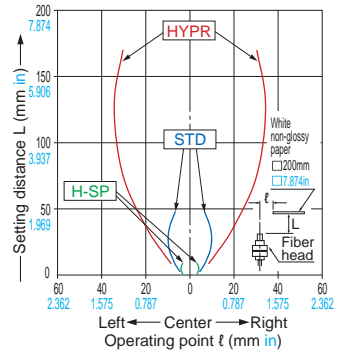

FD-EG30S Reflective type

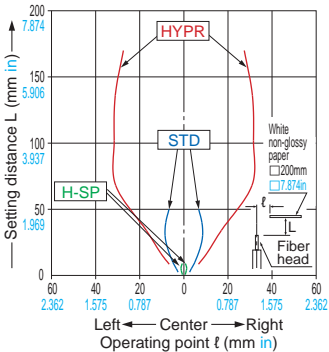

FD-EG31 Reflective type

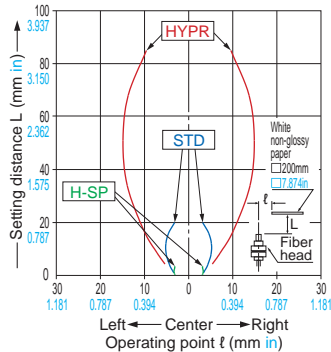

FD-H13-FM2 Reflective type

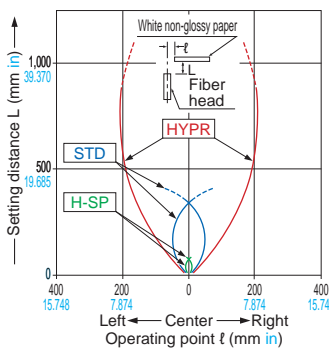

FD-H18-L31 Reflective type

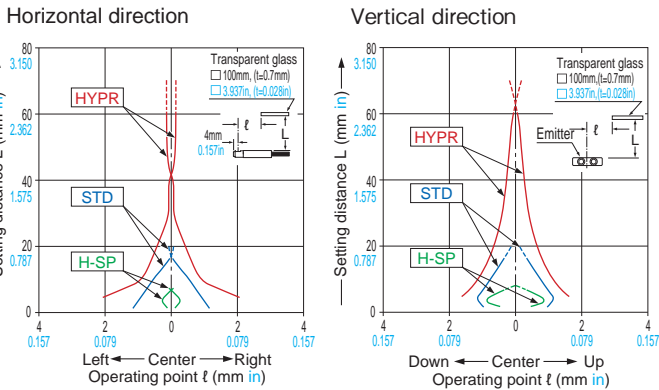

FD-H20-21 Reflective type

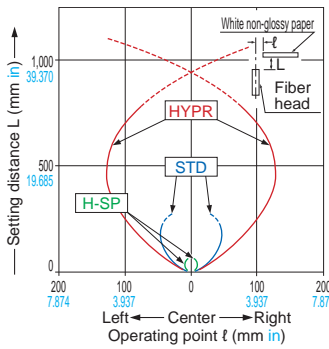

FD-H20-M1 Reflective type

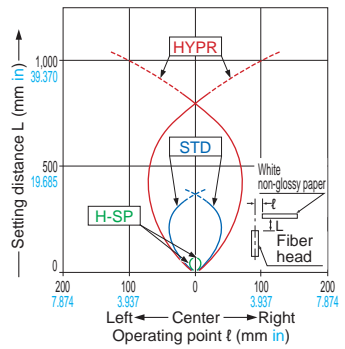

FD-H25-L43 Reflective type

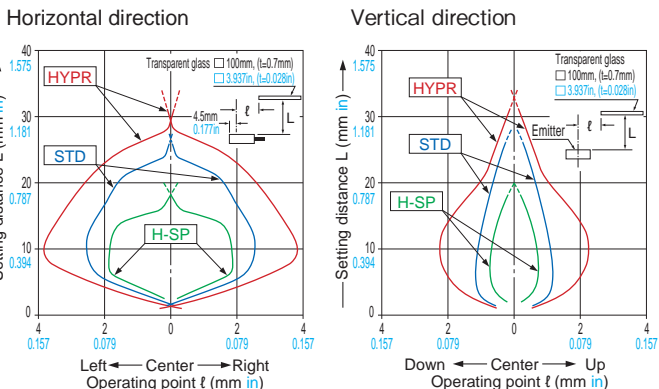

- New product introduction
- Tough Fiber
- Fiber Selection Guide
- Model
- Choose by shape/application
- How to read Model No
- Earlier models comparison table
- Fibers
- Super Quality
- Threaded Type
- Square Head Type
- Cylindrical Type
- Sleeve
- Flat Type
- Small Spot
- Narrow Beam
- Wide Beam
- Convergent Reflective Type
- Retroreflective Type
- Chemical / Oil-resistant
- Heat-resistant
- Vacuum-resistant
- Liquid Leak / Liquid Detection
- Fiber Options
- Semi-custom fibers
- Fiber Dimensions
- Thru-beam Type
- Retroreflective Type
- Reflective Type
- Others
- Amplifiers
- FX-500 series
- FX-100 series
- INDEX

SENSING CHARACTERISTICS (TYPICAL)

Reflective type Sensing field Sensing characteristics are listed in the alphabetic order of the Model No. (Models with same sensing characteristics are grouped together.)

FD-H25-L45 Reflective type

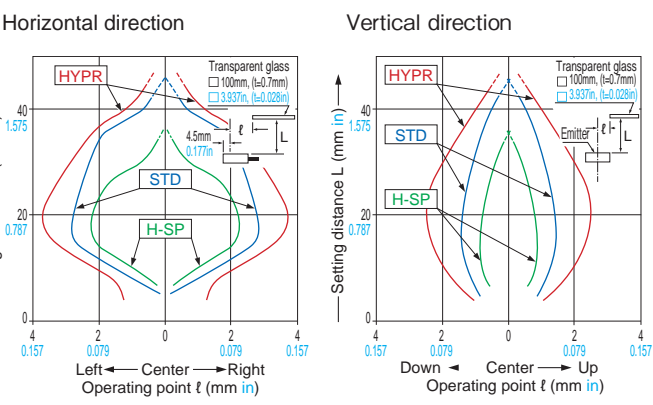

FD-H30-L32 Reflective type

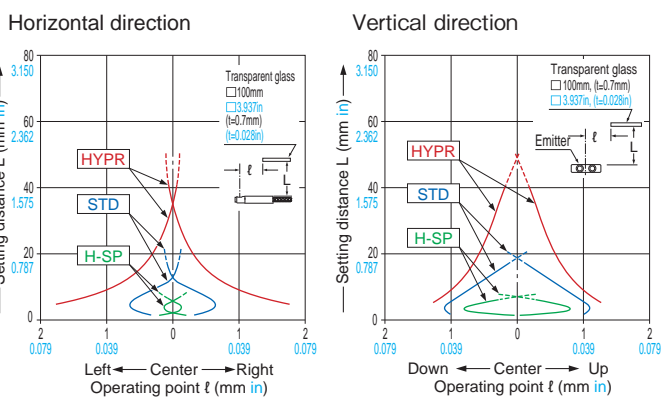

FD-H30-L32V-S Reflective type

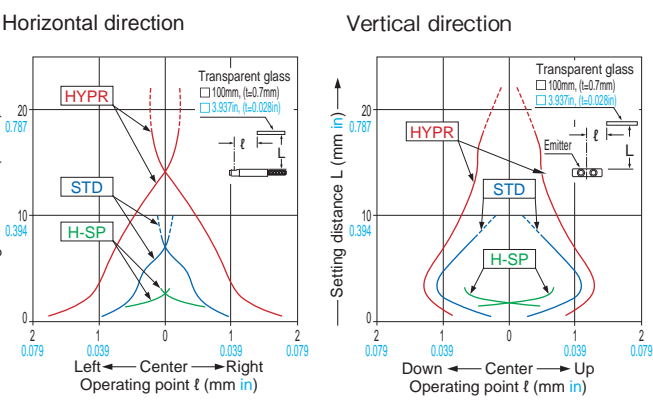

FD-H35-20S Reflective type

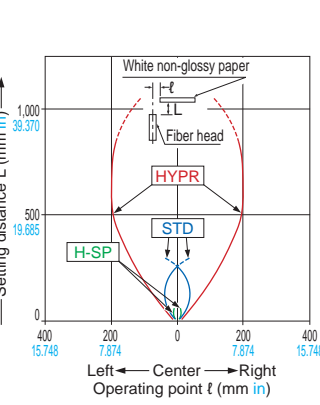

FD-H35-M2 Reflective type
FD-H35-M2S6

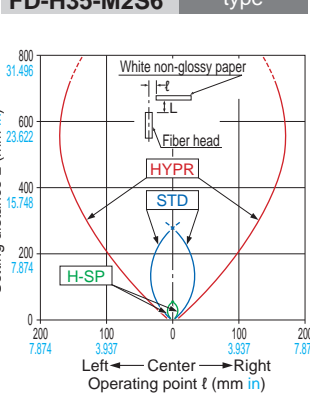

FD-L10 Reflective type

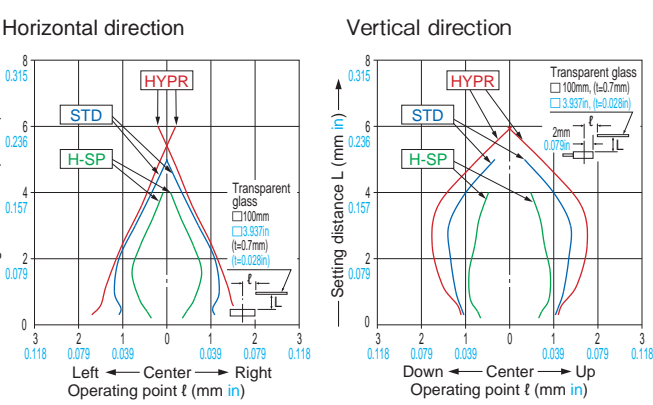

FD-L11 Reflective type

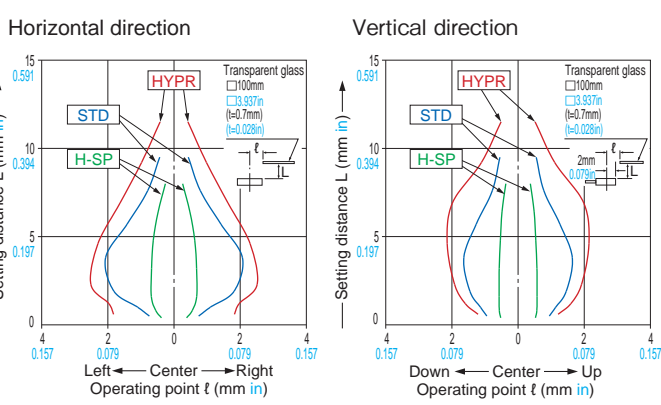

FD-L12W Reflective type

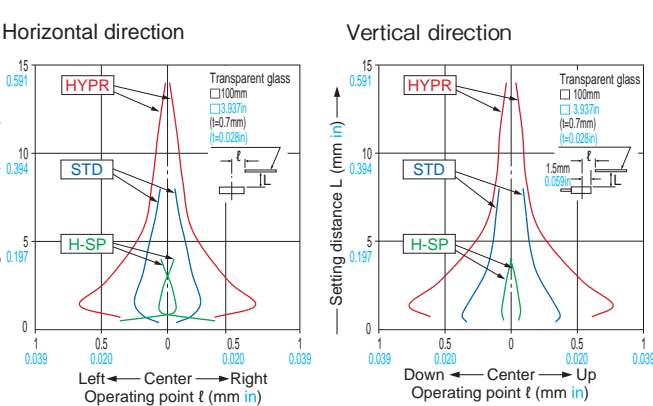

FD-L20H Reflective type

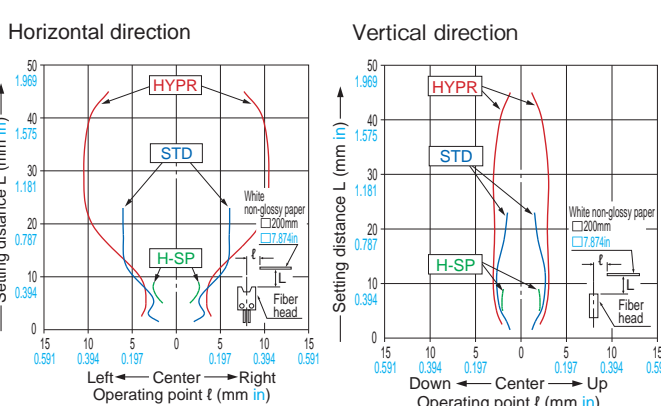

New product introduction
Tough Fiber

Fiber Selection Guide

Model
Choose by shape/application
How to read Model No.
Earlier models comparison table

Fibers

Super Quality
Threaded Type

Square Head Type
Cylindrical Type

Sleeve

Flat Type
Small Spot

Narrow Beam
Wide Beam

Convergent Reflective Type
Retroreflective Type

Chemical / Oil-resistant
Heat-resistant

Vacuum-resistant
Liquid Leak / Liquid Detection

Fiber Options

Semi-custom fibers

Fiber Dimensions
Thru-beam Type

Retroreflective Type
Reflective Type

Others

Amplifiers

FX-500 series

FX-100 series

INDEX

SENSING CHARACTERISTICS (TYPICAL)

Reflective type Sensing field Sensing characteristics are listed in the alphabetic order of the Model No.

FD-L21 Reflective type

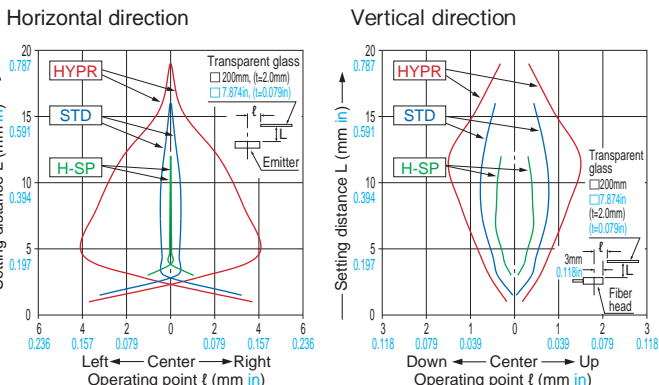

FD-L21W Reflective type

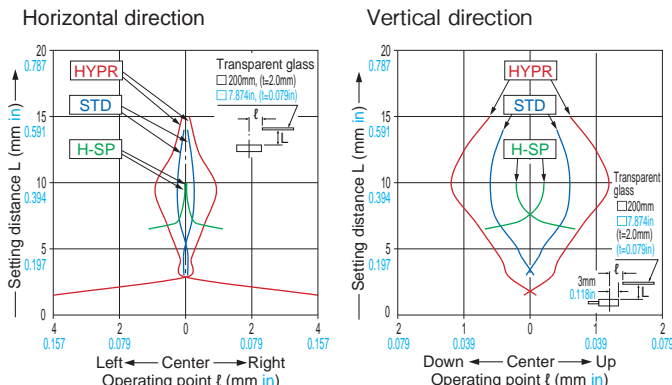

FD-L22A Reflective type

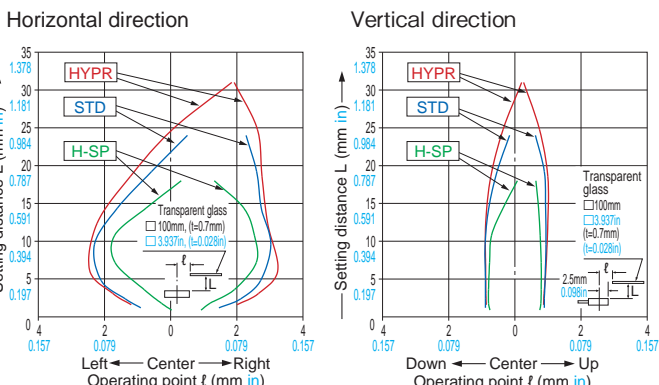

FD-L23 Reflective type

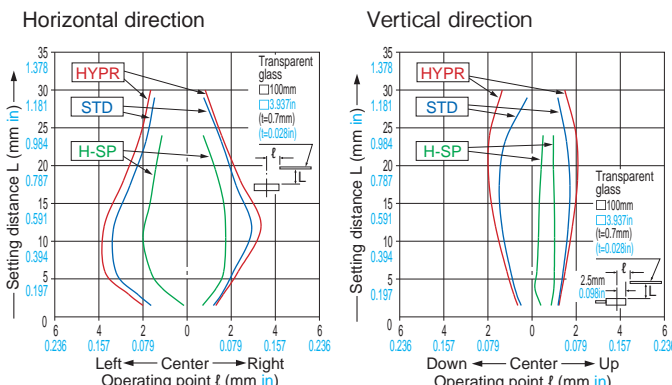

FD-L30A Reflective type

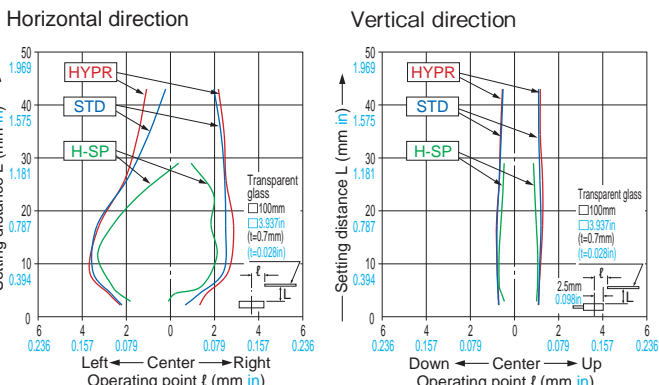

FD-L31A Reflective type

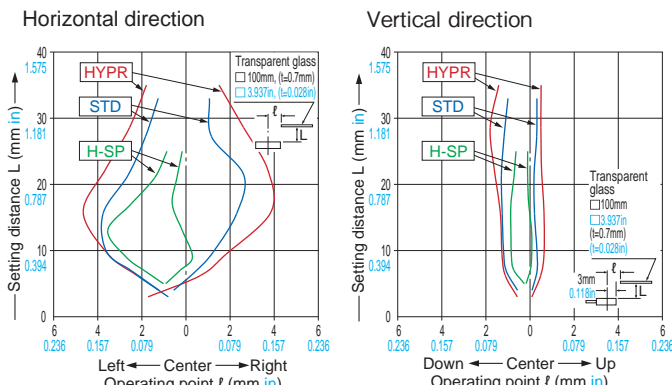

FD-L32H Reflective type

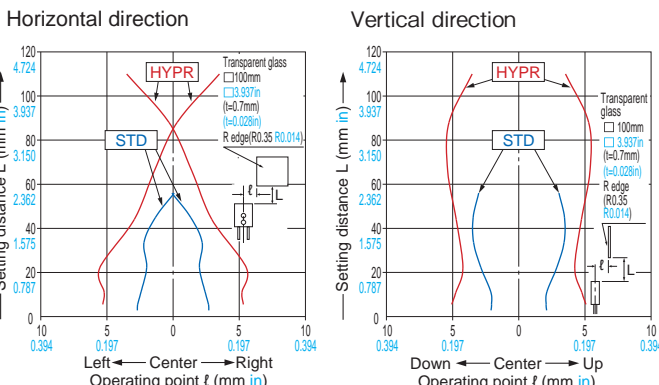

FD-R60 Reflective type

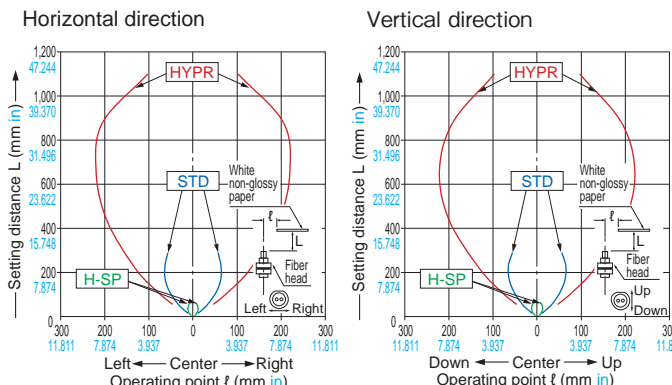

Fiber Selection Guide
Model
Choose by shape/application
How to read Model No.
Earlier models comparison table

Fibers
Super Quality
Threaded Type
Square Head Type
Cylindrical Type
Sleeve
Flat Type
Small Spot
Narrow Beam
Wide Beam
Convergent Reflective Type
Retroreflective Type
Chemical / Oil-resistant
Heat-resistant
Vacuum-resistant
Liquid Leak / Liquid Detection

Fiber Options
Semi-custom fibers
Fiber Dimensions
Thru-beam Type
Retroreflective Type
Reflective Type
Others

Amplifiers
FX-500 series
FX-100 series

INDEX

SENSING CHARACTERISTICS (TYPICAL)

Reflective type Sensing field Sensing characteristics are listed in the alphabetic order of the Model No.

FD-R61Y Reflective type

Horizontal direction

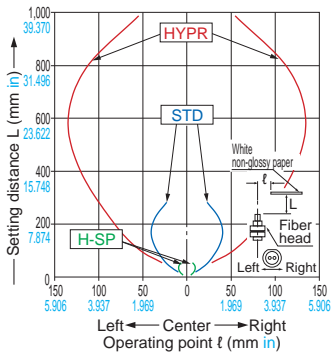

Vertical direction

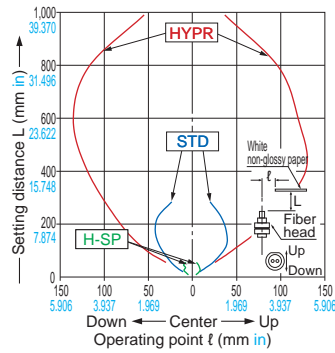

FD-S21 Reflective type

Horizontal direction

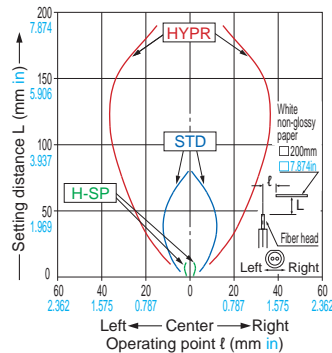

Vertical direction

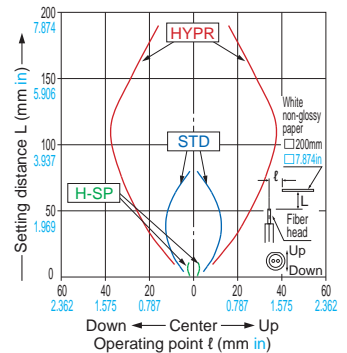

FD-S30 Reflective type

Horizontal direction

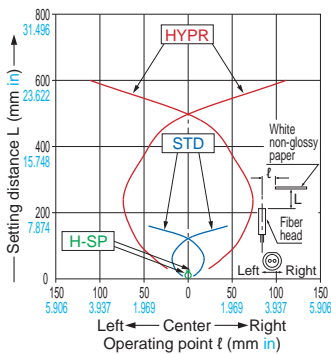

Vertical direction

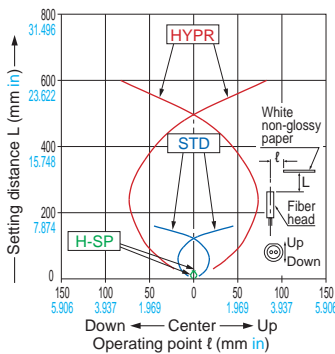

FD-S31 Reflective type

Horizontal direction

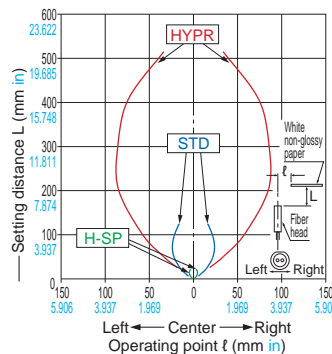

Vertical direction

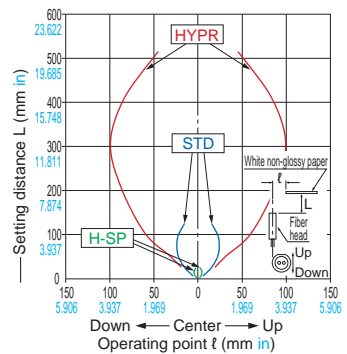

FD-S32 Reflective type

Horizontal direction

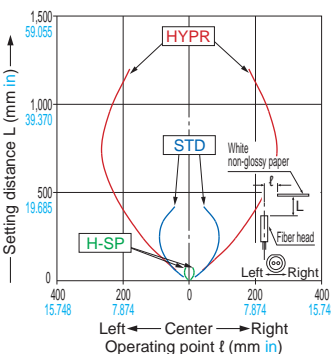

Vertical direction

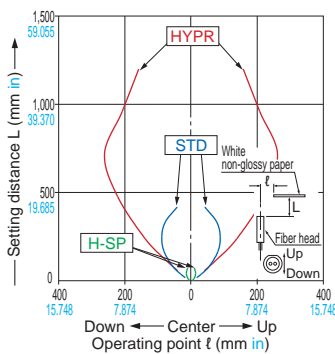

FD-S32W Reflective type

Horizontal direction

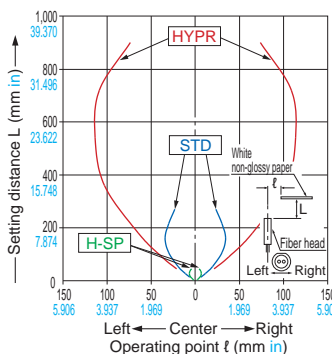

Vertical direction

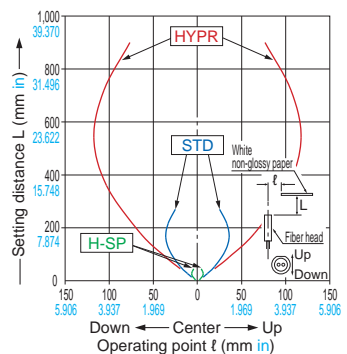

FD-S33GW Reflective type

Horizontal direction

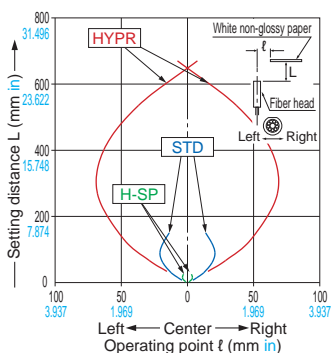

FD-S60Y Reflective type

Horizontal direction

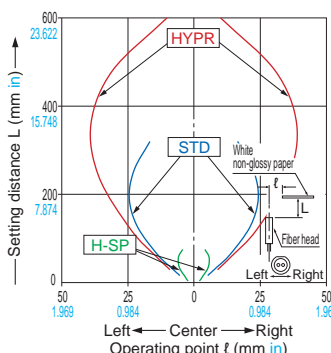

Vertical direction

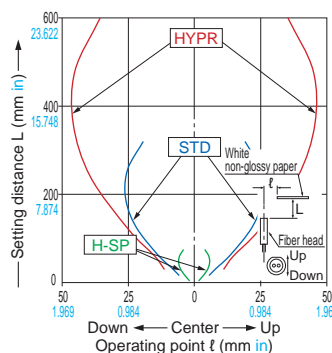

New product introduction

Tough Fiber

Fiber Selection Guide

Model

Choose by shape/application

How to read Model No.

Earlier models comparison table

Fibers

Super Quality

Threaded Type

Square Head Type

Cylindrical Type

Sleeve

Flat Type

Small Spot

Narrow Beam

Wide Beam

Convergent Reflective Type

Retroreflective Type

Chemical / Oil-resistant

Heat-resistant

Vacuum-resistant

Liquid Leak / Liquid Detection

Fiber Options

Semi-custom fibers

Fiber Dimensions

Thru-beam Type

Retroreflective Type

Reflective Type

Others

Amplifiers

FX-500 series

FX-100 series

INDEX

SENSING CHARACTERISTICS (TYPICAL)

Reflective type Sensing field Sensing characteristics are listed in the alphabetic order of the Model No.

FD-V30

Reflective type

Horizontal direction

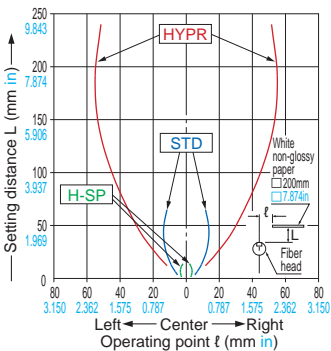

Vertical direction

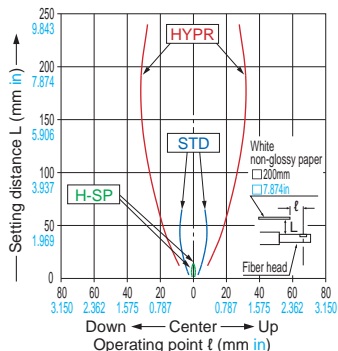

FD-V30W

Reflective type

Horizontal direction

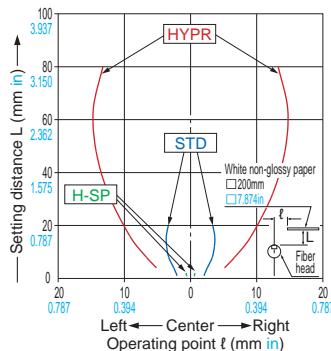

Vertical direction

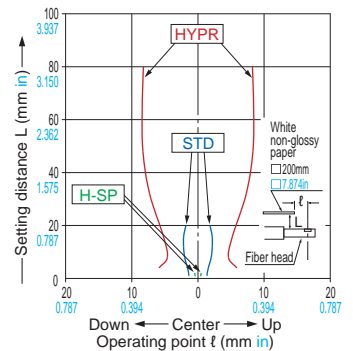

FD-V50

Reflective type

Horizontal direction

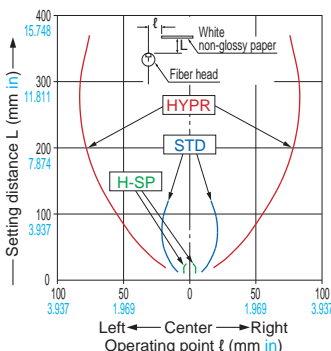

Vertical direction

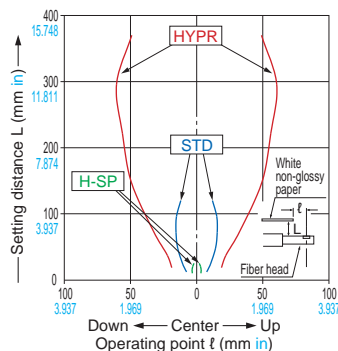

FD-Z20HBW

Reflective type

Horizontal direction

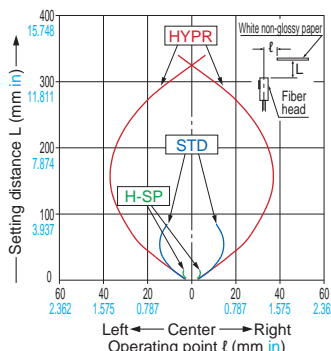

Vertical direction

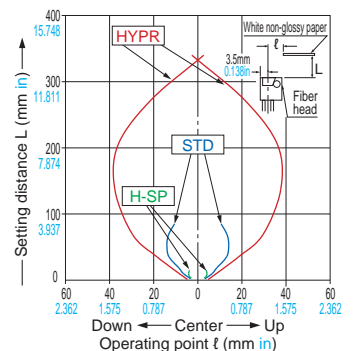

FD-Z20W

Reflective type

Horizontal direction

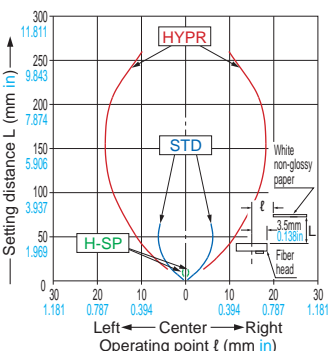

Vertical direction

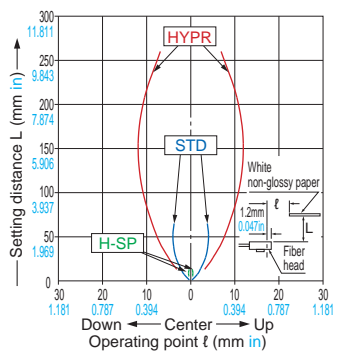

FD-Z40HBW

Reflective type

Horizontal direction

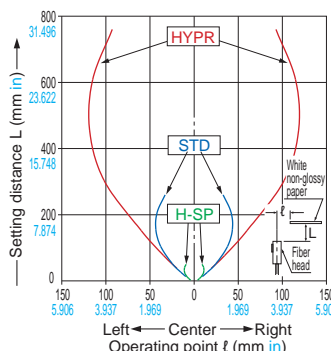

Vertical direction

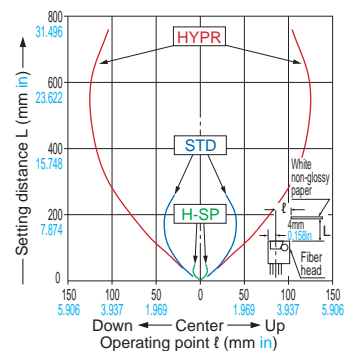

FD-Z40W

Reflective type

Horizontal direction

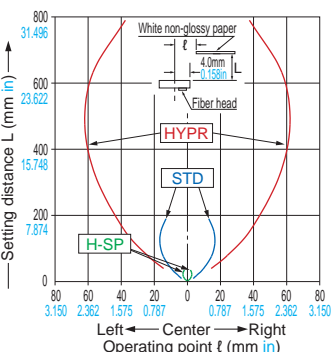

Vertical direction

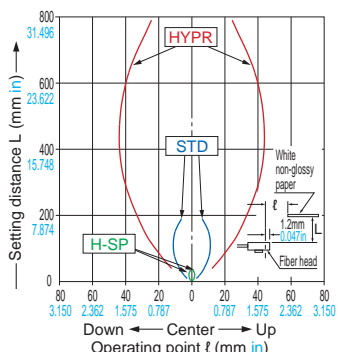

FD-Z50HW

Reflective type

Horizontal direction

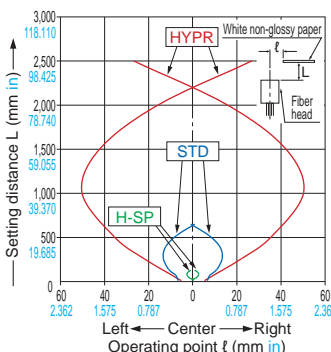

Vertical direction

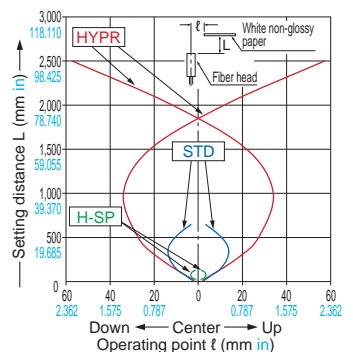

Fiber Selection Guide

Model

Choose by shape/application

How to read Model No

Earlier models comparison table

Fibers

Super Quality

Threaded Type

Square Head Type

Cylindrical Type

Sleeve

Flat Type

Small Spot

Narrow Beam

Wide Beam

Convergent Reflective Type

Retroreflective Type

Chemical / Oil-resistant

Heat-resistant

Vacuum-resistant

Liquid Leak / Liquid Detection

Fiber Options

Semi-custom fibers

Fiber Dimensions

Thru-beam Type

Retroreflective Type

Reflective Type

Others

Amplifiers

FX-500 series

FX-100 series

INDEX

PRECAUTIONS FOR PROPER USE

Refer to the "PRO mode operation manual" on our website for details.



- Never use this product as a sensing device for personnel protection.
- In case of using sensing devices for personnel protection, use products which meet laws and standards, such as OSHA, ANSI or IEC etc., for personnel protection applicable in each region or country.

Wiring

- Make sure that the power supply is OFF while adding or removing the amplifiers.
- Note that if a voltage exceeding the reted range is applied, or if an AC power supply is directly connected, the product may get burnt or damaged.
- Note that short-circuit of the load or wrong wiring may burn or damage the product.
- Do not run the wires together with high-voltage lines or power lines, or put them in the same raceway. This can cause malfunction due to induction.
- Verify that the supply voltage variation is within the rating.
- If power is supplied from a commercial switching regulator, ensure that the frame ground (F.G.) terminal of the power supply is connected to an actual ground.
- In case noise generating equipment (switching regulator, inverter motor, etc.) is used in the vicinity of this product, connect the frame ground (F.G.) terminal of the equipment to an actual ground.
- Make sure to use the quick-connection cable (optional) for the connection of the controller. Extension up to total 100 m [328.084 ft](#) is possible with 0.3 mm² or more, cable. However, in order to reduce noise, make the wiring as short as possible.
- Make sure that stress by forcible bending or pulling is not applied to the sensor cable joint and fiber cable.

Others

- Our products have been developed / produced for industrial use only.
- The specification may not be satisfied in a strong magnetic field.
- The ultra long distance (U-LG, HYPR) mode is more likely to be affected by extraneous noise since the sensitivity of that is higher than the other modes. Make sure to check the environment before use.
- Do not use during the initial transient time (H-SP, FAST, STD: 0.5 sec., LONG, U-LG, HYPR: 1 sec.) after the power supply is switched ON.
- These sensors are only for indoor use.
- Avoid dust, dirt, and steam.
- Make sure that the product does not come in contact with oil, grease, organic solvents such as thinner, etc., strong acid or alkaline.
- This product cannot be used in an environment containing inflammable or explosive gases.
- Never disassemble or modify this product.
- This product adopts EEPROM. Settings cannot be done a million times or more because of the EEPROM's lifetime.

New product introduction

Tough Fiber

Fiber Selection Guide

Model

Choose by shape/application

How to read Model No.

Earlier models comparison table

Fibers

Super Quality

Threaded Type

Square Head Type

Cylindrical Type

Sleeve

Flat Type

Small Spot

Narrow Beam

Wide Beam

Convergent Reflective Type

Retroreflective Type

Chemical / Oil-resistant

Heat-resistant

Vacuum-resistant

Liquid Leak / Liquid Detection

Fiber Options

Semi-custom fibers

Fiber Dimensions

Thru-beam Type

Retroreflective Type

Reflective Type

Others

Amplifiers

FX-500 series

FX-100 series

INDEX

PRECAUTIONS FOR PROPER USE

Abstract from "PRO MODE OPERATION MANUAL"

PRO mode

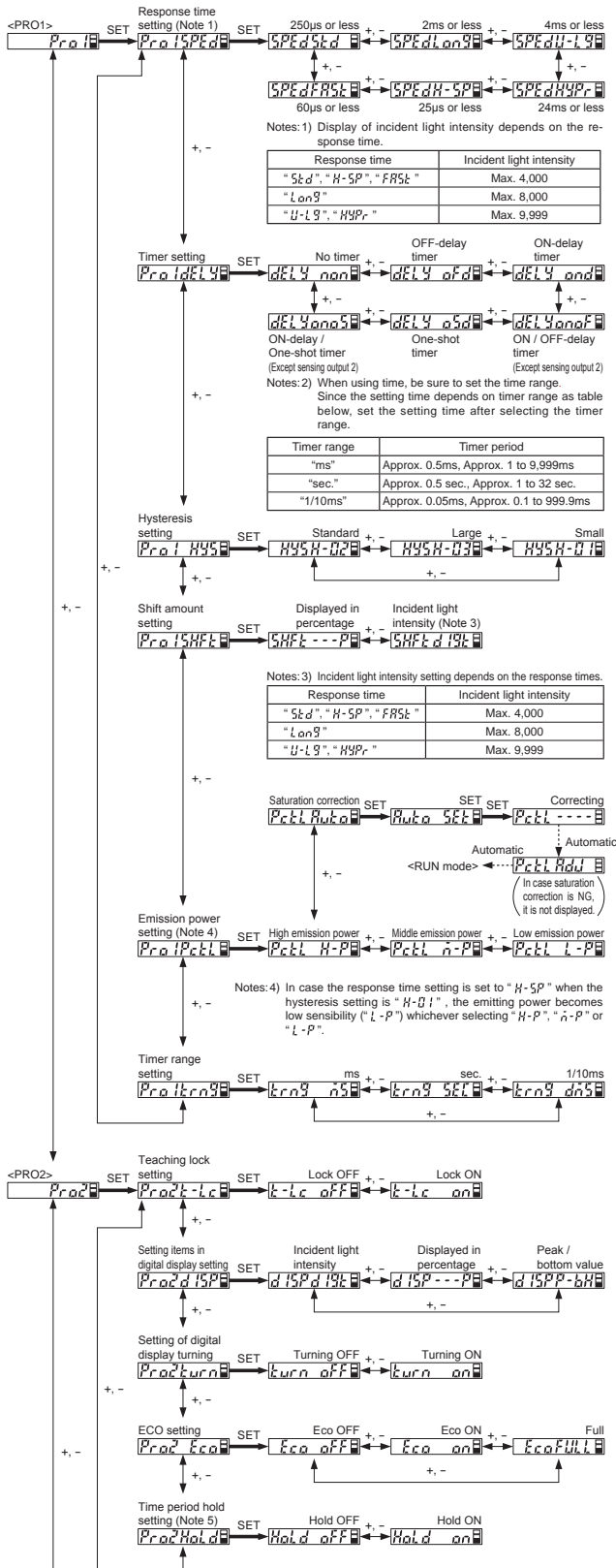

Part description

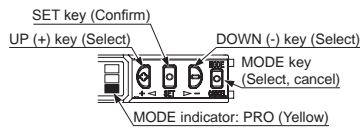

Symbol explanation

- SET → Press the SET key.
- +/- → Press the UP (+) key or DOWN (-) key.
- Automatic → Automatically move to next

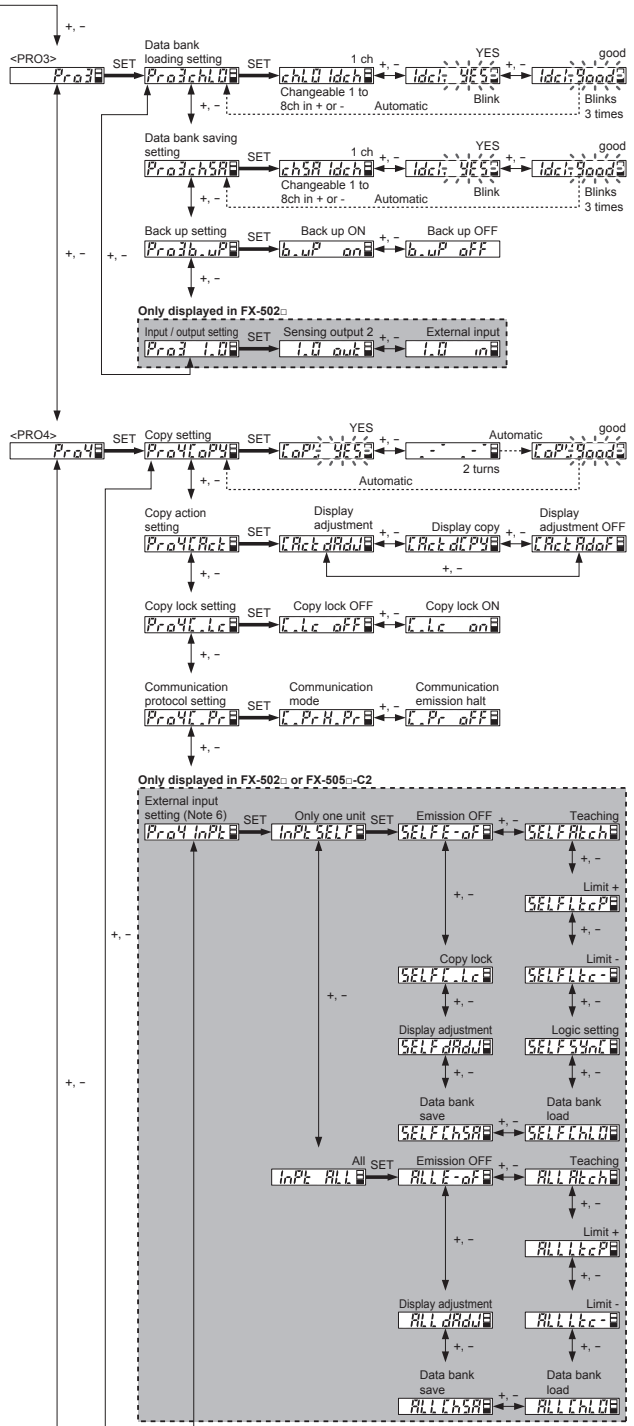

Notes: 6) The signal input time from outside is as follows.

	Input time
2 point teaching	20 to under 500ms
Limit teaching	
Display adjust	
Full auto teaching	600ms or more (sampling during input)
Emission OFF, Logic setting	2ms or more (conducted during inputting)
Copy lock	
Data bank loading	Input pulse of the specified channel number (1 pulse: 16 to 300ms). However, the pulse cycle is under 500ms.
Data bank saving	

PRECAUTIONS FOR PROPER USE

Abstract from "PRO MODE OPERATION MANUAL"

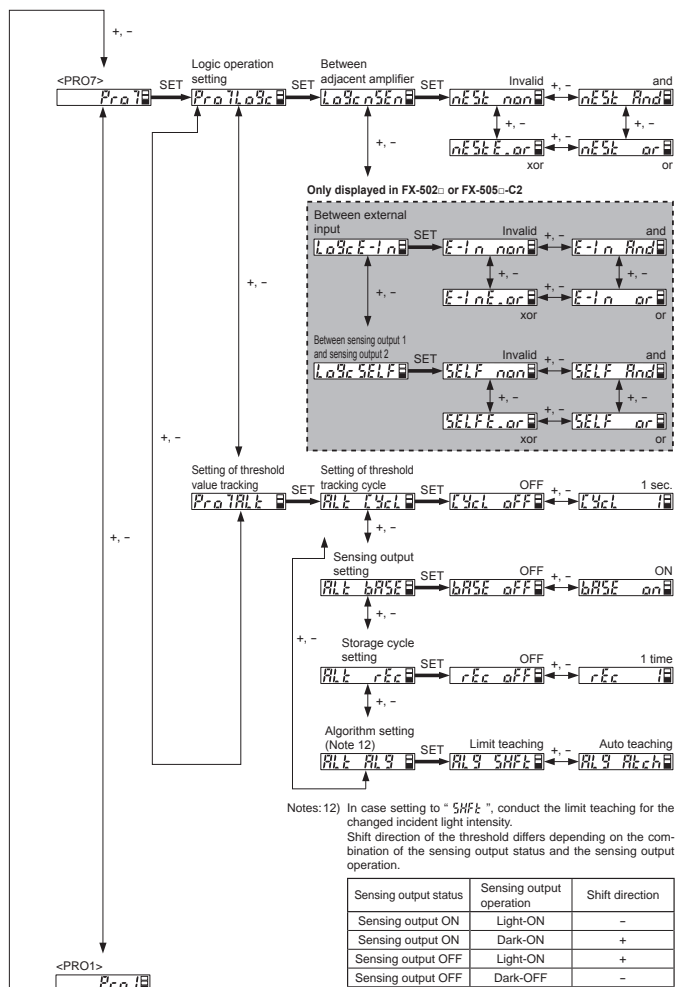
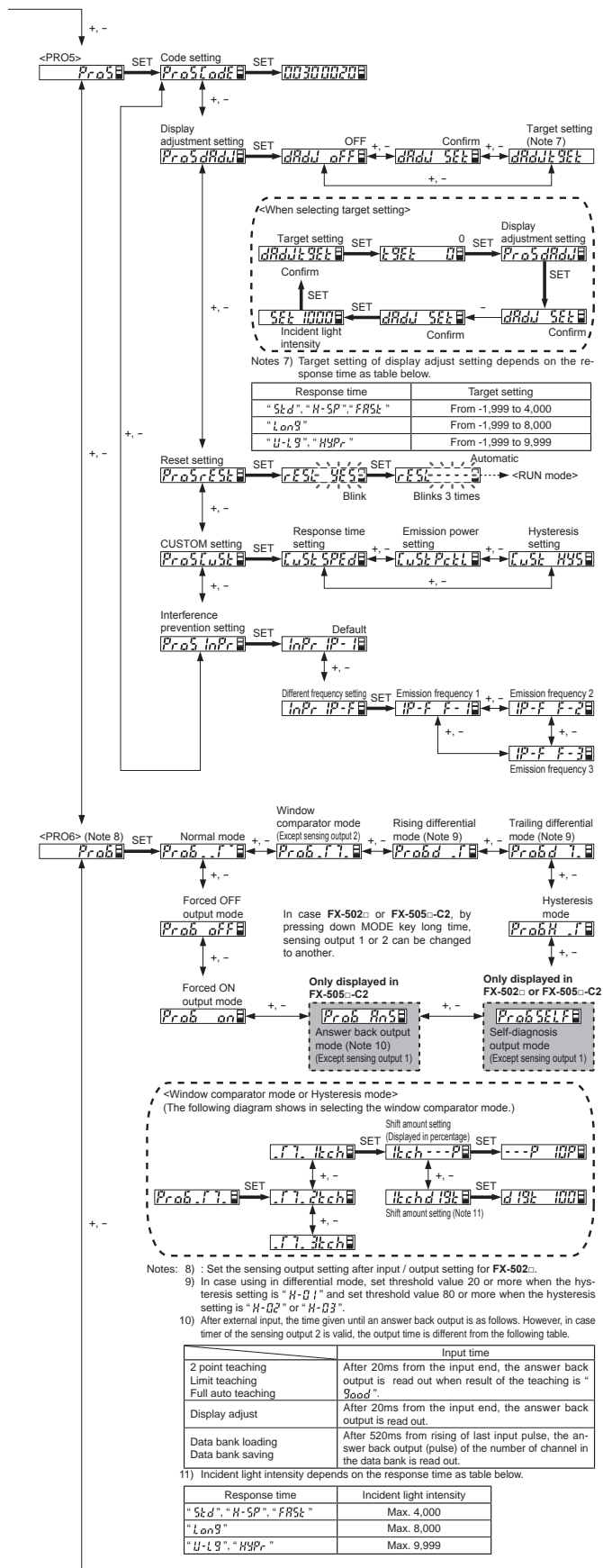

Notes: 12) In case setting to "SHft", conduct the limit teaching for the changed incident light intensity. Shift direction of the threshold differs depending on the combination of the sensing output status and the sensing output operation.

- Notes: 8) : Set the sensing output setting after input / output setting for FX-502 \pm .
 9) In case using in differential mode, set threshold value 20 or more when the hysteresis setting is "H-01" and set threshold value 80 or more when the hysteresis setting is "H-02" or "H-03".
 10) After external input, the time given until an answer back output is as follows. However, in case timer of the sensing output 2 is valid, the output time is different from the following table.
- | | Input time |
|--------------------|--|
| 2 point teaching | After 20ms from the input end, the answer back output is read out when result of the teaching is "Good". |
| Limit teaching | |
| Full auto teaching | |
| Display adjust | After 20ms from the input end, the answer back output is read out. |
| Data bank loading | After 520ms from rising of fast input pulse, the answer back output (pulse) of the number of channel in the data bank is read out. |
| Data bank saving | |
- 11) Incident light intensity depends on the response time as table below.
- | Response time | Incident light intensity |
|-----------------------|--------------------------|
| "Std", "H-SP", "FRSt" | Max. 4,000 |
| "Lan9" | Max. 8,000 |
| "U-L9", "HYPr" | Max. 9,999 |

New product introduction
 Tough Fiber
 Fiber Selection Guide
 Model
 Choose by shape/application
 How to read Model No.
 Earlier models comparison table
 Fibers
 Super Quality
 Threaded Type
 Square Head Type
 Cylindrical Type
 Sleeve
 Flat Type
 Small Spot
 Narrow Beam
 Wide Beam
 Convergent Reflective Type
 Retroreflective Type
 Chemical / Oil-resistant
 Heat-resistant
 Vacuum-resistant
 Liquid Leak / Liquid Detection
 Fiber Options
 Semi-custom fibers
 Fiber Dimensions
 Thru-beam Type
 Retroreflective Type
 Reflective Type
 Others
 Amplifiers
 FX-500 series
 FX-100 series
 INDEX

DIMENSIONS (Unit: mm in)

Refer to p.48 ~ for details of fiber dimensions.

The CAD data in the dimensions can be downloaded from our website.

FX-501(P) FX-502(P) Amplifier

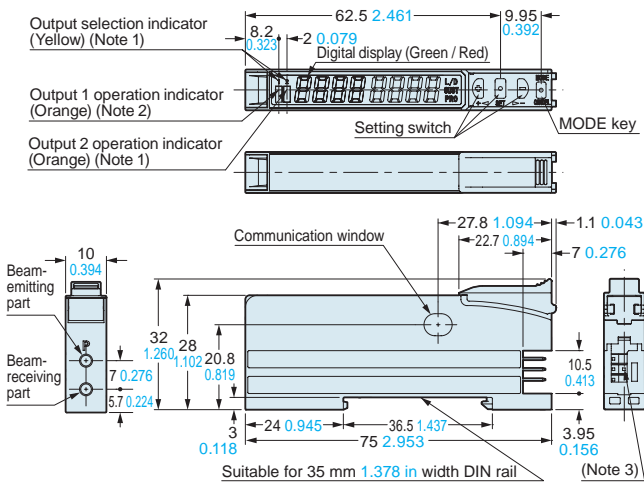

- Notes: 1) FX-502(P) only
- 2) FX-501(P): Operation indicator
- 3) FX-501(P): 3-pin, FX-502(P): 4-pin

FX-505-C2 FX-505P-C2 Amplifier

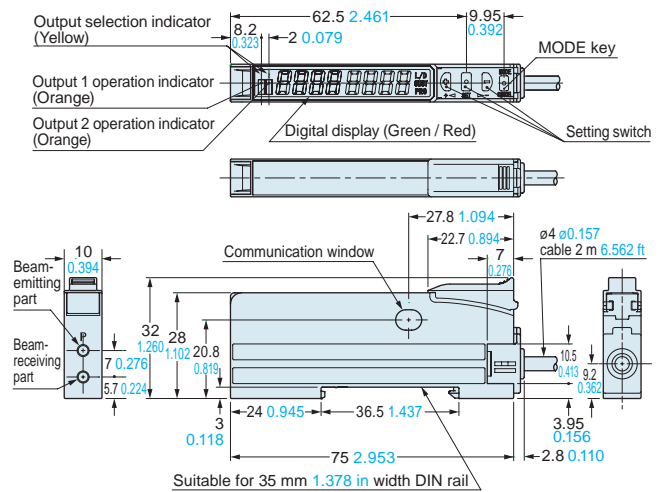

CN-73-C□ CN-74-C□ Main cable (Optional)

• Length L

Model No.	Length L
CN-73/74-C1	1,000 39.370
CN-73/74-C2	2,000 78.740
CN-73/74-C5	5,000 196.850

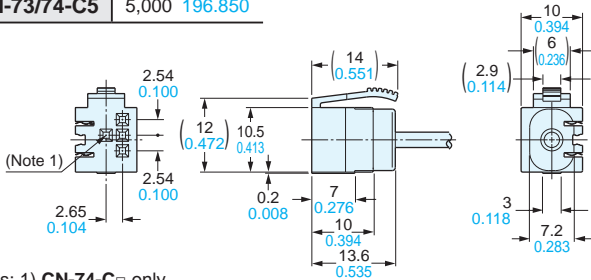
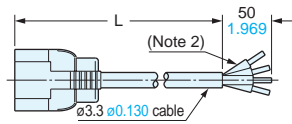

- Notes: 1) CN-74-C□ only
- 2) CN-73-C□: 3-core

CN-71-C□ CN-72-C□ Sub cable (Optional)

• Length L

Model No.	Length L
CN-71/72-C1	1,000 39.370
CN-71/72-C2	2,000 78.740
CN-71/72-C5	5,000 196.850

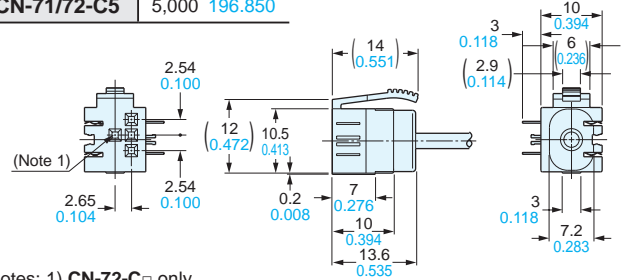
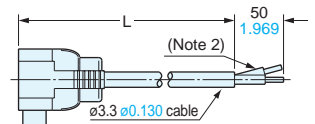

- Notes: 1) CN-72-C□ only
- 2) CN-71-C□: 1-core

MS-DIN-2 Amplifier mounting bracket (Optional)

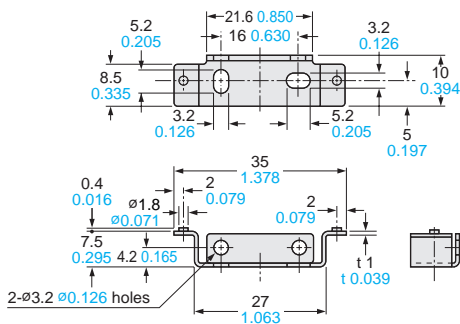

Material: Cold rolled carbon steel (SPCC)
(Uni-chrome plated)

MS-DIN-E End plate (Optional)

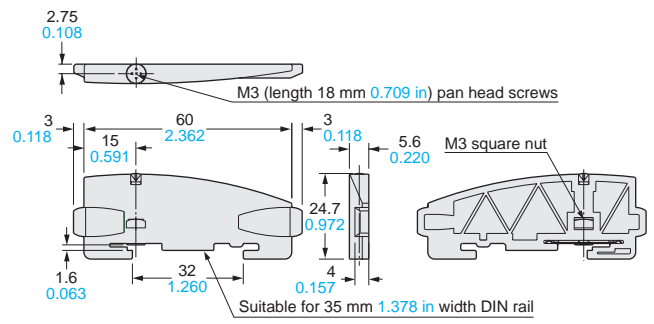

Material: Polycarbonate

New product introduction
Tough Fiber

Fiber Selection Guide

Model
Choose by shape/application
How to read Model No
Earlier models comparison table

Fibers

Super Quality
Threaded Type
Square Head Type
Cylindrical Type
Sleeve
Flat Type
Small Spot
Narrow Beam
Wide Beam
Convergent Reflective Type
Retroreflective Type
Chemical / Oil-resistant
Heat-resistant
Vacuum-resistant
Liquid Leak / Liquid Detection

Fiber Options

Semi-custom fibers

Fiber Dimensions

Thru-beam Type
Retroreflective Type
Reflective Type
Others

Amplifiers

FX-500 series
FX-100 series

INDEX

Taking fiber sensors to the next level



* The FX-100 series has been changed to Panasonic brand from production in and after July 2011.
* Cover opened state is shown.



Good dual digital display

The threshold value and incident light intensity can be both confirmed at the same time, bringing good operability when making changes of each setting.



Threshold value Incident light intensity

Commercially-available connectors reduce lead time and spare part numbers

Compatible with commercially-available connectors, so that processing costs and lead time required for processing after purchase can be greatly reduced. The connection parts same as the DP-100 series digital pressure sensors and the PM-64 series micro photoelectric sensors can be commonly used.



Commercially-available crimping connectors are used, so that the processing costs for connection cables can be greatly reduced.

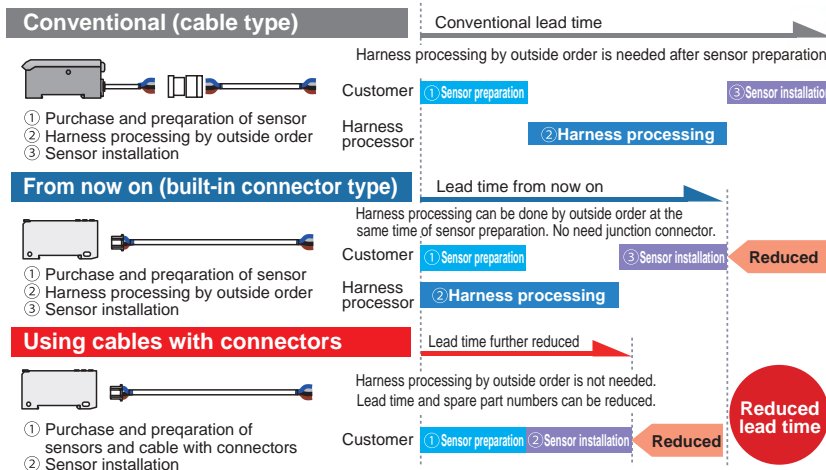

Saving-space with a width of 9 mm 0.354 in

Very slim body at only 9 mm 0.354 in. This is much thinner than existing fiber sensors. This makes a very large difference when using many units, even if the difference of one unit is small.



Improved stability over long terms

Utilizes "Four-chemical emitting element" for light emission. The light emission is guaranteed to be stable over long periods of time.

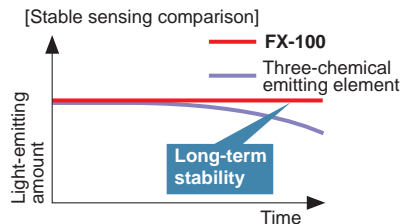

Simple operation due to clear configuration system

Continued to use the configuration system of digital pressure sensor DP-100 series, which has received high popularity since its release. We have separated the settings into three levels: RUN mode, SET mode, and PRO mode, making operation simpler and easier.

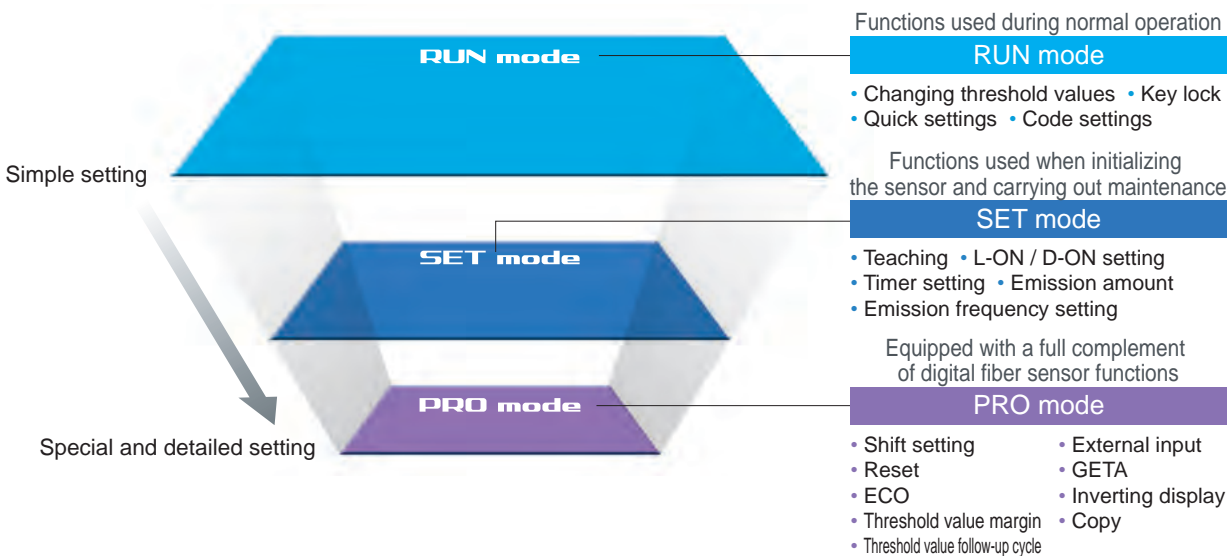

Quick code input function

RUN mode

Simply inputting the default setting "code (number)" will enable sensor settings. Even if the settings are accidentally changed, inputting the code will restore the default settings.

Confirmation can be carried out smoothly via telephone by simply quoting numbers. This can be of great assistance when dealing with foreign country customers.



Quick setting: Press and simultaneously for 2 sec.

Code setting: Press and simultaneously for 4 sec.

Quick setting numbers (abstract)

No	Output operation	Timer	Emission amount setting
-00-	Dark-ON	None	OFF
-01-	Dark-ON	None	ON
-02-	Dark-ON	OFF-delay 10 ms	OFF
-03-	Dark-ON	OFF-delay 10 ms	ON
-10-	Light-ON	ON-delay 40 ms	ON
-11-	Light-ON	ON-delay 40 ms	OFF
-12-	Light-ON	ON-delay 10 ms	ON
-13-	Light-ON	ON-delay 10 ms	OFF

Refer to "Quick setting function" and "Code setting function" in "PRECAUTIONS FOR PROPER USE" for details.

New product introduction
Tough Fiber

Fiber Selection Guide
Model
Choose by shape/application
How to read Model No.
Earlier models comparison table

Fibers

Super Quality
Threaded Type
Square Head Type
Cylindrical Type
Sleeve
Flat Type
Small Spot
Narrow Beam
Wide Beam
Convergent Reflective Type
Retroreflective Type
Chemical / Oil-resistant
Heat-resistant
Vacuum-resistant
Liquid Leak / Liquid Detection

Fiber Options

Semi-custom fibers

Fiber Dimensions
Thru-beam Type
Retroreflective Type
Reflective Type
Others

Amplifiers
FX-500 series
FX-100 series

INDEX

Teaching with ON / OFF keys

SET mode

Simply press the ON key when an object is present, and OFF when it is not, and teaching is completed. There is no need to consider difference between Light-ON and Dark-ON.

<Setting example>

Thru-beam type / Retroreflective type

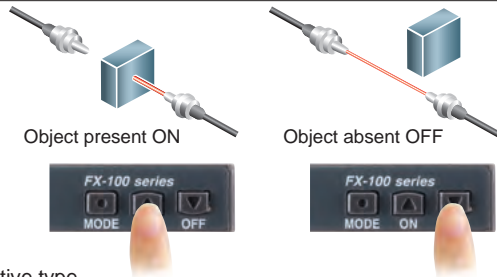

Reflective type

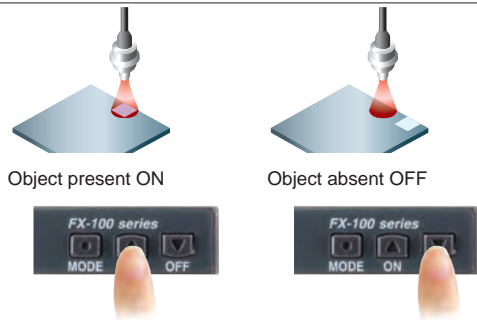

Teaching even without an object — Limit teaching function

Threshold value can be set by performing teaching only when an object is absent (when the incident light amount is stable). This is useful when there are other objects in the background also when detecting a minute objects. Teaching can also be carried out using external input.

Threshold value follow-up cycle setting function

PRO mode

This function performs automatic setting to threshold value by checking the incident light intensity at desired intervals in order to follow the changes in the light amount resulting from changes in the environment over long periods (such as dust). Contributes to reduction in maintenance hours.

* Effective when the output operation is set to Dark-ON, and when using thru-beam type or retroreflective type fibers.

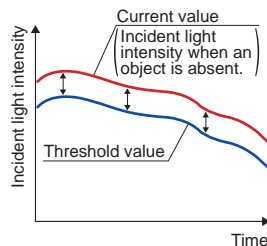

Resolves variation in incident light intensity display GETA function

PRO mode

Even when performing the same sensing operation, there may be variances in the digital values of the fiber amp. There is no problem with the sensor itself, but the operator may find it troubling.

Given value can be corrected with the GETA function, so the apparent variation can be eliminated and the creation of operation manuals can proceed smoothly.

Variations in the amount of light received



Unify at 500 using the GETA function

Example of current incident light intensity display of '500' is adjusted to '1000'

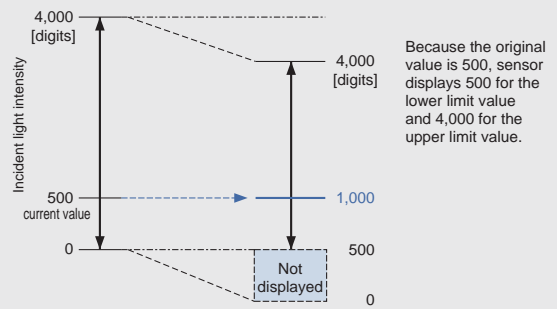

Emission amount setting function

SET mode

Emission amount can be reduced in order to achieve stable detection when the receiving light level is saturated, such as detection at close range and detection of transparent or minute objects. Previously, the emission amount level was only one, but from production in December 2007, four level setting (three level + auto setting) has become available. This function brings easier settings than before.

【Light receiving level saturated】

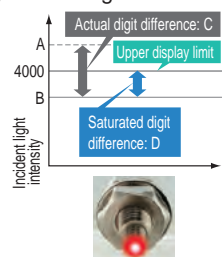

【Stable sensing】

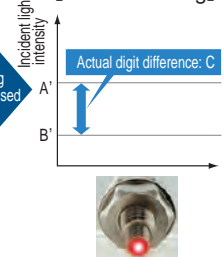

Light emitting amount decreased

New product introduction
Tough Fiber

Fiber Selection Guide

Model
Choose by shape/application
How to read Model No
Earlier models comparison table

Fibers

Super Quality
Threaded Type
Square Head Type
Cylindrical Type
Sleeve
Flat Type
Small Spot
Narrow Beam
Wide Beam

Convergent Reflective Type
Retroreflective Type
Chemical / Oil-resistant
Heat-resistant
Vacuum-resistant
Liquid Leak / Liquid Detection

Fiber Options

Semi-custom fibers

Fiber Dimensions

Thru-beam Type
Retroreflective Type
Reflective Type
Others

Amplifiers

FX-500 series
FX-100 series

INDEX

Emission frequency setting mode SET mode

Mutual interference is prevented for max. 3 units for standard type **FX-101** and max. 4 units in case of long sensing range type **FX-102**. During setting of interference prevention, emitter and output indicator both flash, so it is convenient to confirm which fiber is in the setting process at a glance. Emitter flashes even when an amplifier is not installed close together.

* When the emission frequency is changed, a response time is also changed.

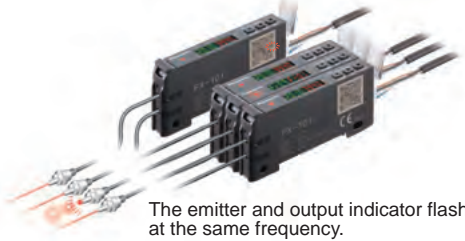

External input setting mode PRO mode

External input can be selected from emission halt, limit teaching / full-auto teaching / 2-level teaching, ECO or emission amount test. Threshold value set at each teaching is also memorized.

* 2-level teaching, emission amount test and threshold value storing setting are available in amplifiers manufactured after December 2007.

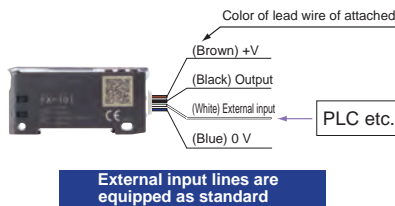

Digital display inversion setting PRO mode

The viewing orientation of the digital display can be inverted in accordance with the setting direction of the amplifier.

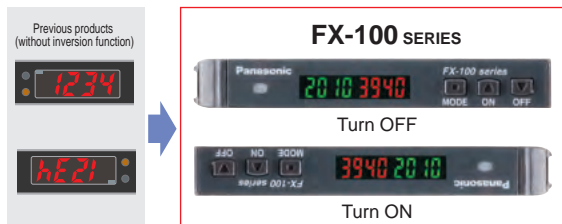

Alert function PRO mode

When the amount light received approaches the threshold value, the display can be made to blink in order to alert the operator.

<When using at a shift amount of 20% and a threshold value of 1,000>
The amount of light received ranges from about 900 to 1,100 when the digital indicator flashes.

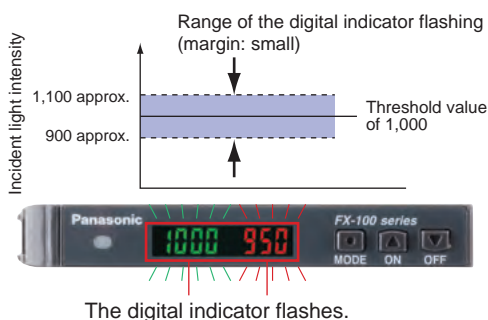

Setting copy function to reduce man-hours and human error PRO mode

By connecting a fiber sensor to the master fiber sensor, the master sensor settings can be copied along with data communications. When the same settings are input to several units, trouble from setting errors can be prevented, also changes to the work order will be small when equipment design is changed.

<Wiring to copy settings>

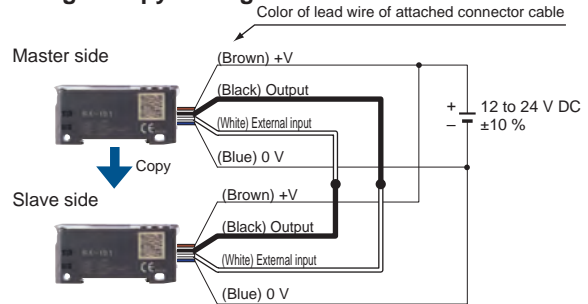

These settings can be copied

Threshold value, output operation, timer operation, timer emission amount, shift, external input, threshold value-storing, ECO inverting digital display, and threshold value margin

Without mounting bracket

Selectable either mounting on DIN rail or direct mounting with through hole. Direct mounting brings stability even on a movable parts or installation of a single unit.



Available from standard type or long sensing range type

Standard type and long sensing range type are available which has various response time and sensing range. The model best meet application needs can be selected.

Model No.	Type	Sensing range (FT-B8)	Response time
FX-101	Standard type	400 mm 15.748 in	Max. 250 μs
FX-102	Long sensing range type	1,150 mm 45.276 in	Max. 2.5 ms

Power consumption saving with ECO mode

When there is no key operations in approximately 20 seconds, digital display turns off and power consumption can be reduced to 600mW or less (720mW in normal mode).



New product introduction
Tough Fiber

Fiber Selection Guide

Model

Choose by shape/application

How to read Model No.

Earlier models comparison table

Fibers

Super Quality

Threaded Type

Square Head Type

Cylindrical Type

Sleeve

Flat Type

Small Spot

Narrow Beam

Wide Beam

Convergent Reflective Type

Retroreflective Type

Chemical / Oil-resistant

Heat-resistant

Vacuum-resistant

Liquid Leak / Liquid Detection

Fiber Options

Semi-custom fibers

Fiber Dimensions

Thru-beam Type

Retroreflective Type

Reflective Type

Others

Amplifiers

FX-500 series

FX-100 series

INDEX

ORDER GUIDE

Amplifiers

Type	Appearance	Model No.	Emitting element	Output
Standard type		FX-101 (Note 2)	Red LED	NPN open-collector transistor
		FX-101-Z (Note 3)		NPN open-collector transistor
		FX-101P (Note 2)		PNP open-collector transistor
		FX-101P-Z (Note 3)		PNP open-collector transistor
		FX-101-CC2		NPN open-collector transistor
Long sensing range type		FX-101P-CC2		PNP open-collector collector transistor
		FX-102 (Note 2)		NPN open-collector transistor
		FX-102-Z (Note 3)		NPN open-collector transistor
		FX-102P (Note 2)		PNP open-collector transistor
		FX-102P-Z (Note 3)		PNP open-collector transistor
		FX-102-CC2	NPN open-collector transistor	
		FX-102P-CC2	PNP open-collector transistor	

Notes: 1) The connector attached cable 2 m **CN-14A-C2** is supplied with the amplifier.

2) Make sure to use the optional connector attached cable **CN-14A(-R)-C□** or the connector **CN-14A**, or a connector manufactured by J.S.T. Mfg. Co., Ltd. (contact: SPHD-001T-P0.5, housing: PAP-04V-S)

3) Make sure to use the optional M8 connector attached cable **CN-24A-C□**.

Accessory

• CN-14A-C2

(Connector attached cable 2 m 6.562 ft)

* Only include cable set type



• FC-FX-1 (Protection cover)

* It has been attached from the production at July, 2011.

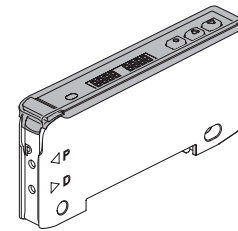

OPTIONS

Designation	Model No.	Description	
Connector attached cable	CN-14A-C1	1 m 3.281 ft	0.2 mm ² 4-core cable with connector on one end Cable outer diameter: $\varnothing 3.7$ mm $\varnothing 0.146$ in
	CN-14A-C2 (Note)	2 m 6.562 ft	
	CN-14A-C3	3 m 9.843 ft	
	CN-14A-C5	5 m 16.404 ft	
	CN-14A-R-C1	1 m 3.281 ft	
Connector attached cable (Flexible type)	CN-14A-R-C2	2 m 6.562 ft	
	CN-14A-R-C3	3 m 9.843 ft	
	CN-14A-R-C5	5 m 16.404 ft	
	CN-14A-R-C5	5 m 16.404 ft	
M8 connector attached cable	CN-24A-C2	2 m 6.562 ft	For M8 plug-in connector type The connector on one end Cable outer diameter: $\varnothing 4$ mm $\varnothing 0.157$ in
	CN-24A-C5	5 m 16.404 ft	
Connector	CN-14A	Set of 10 housings and 40 contacts	
Amplifier mounting bracket	MS-DIN-4	Mounting bracket for amplifier	
End plates	MS-DIN-E	When it moves depending on the way it is installed on a DIN rail, these end plates ensure that all amplifiers are mounted together in a secure and fully connected manner.	
		Two pcs. per set	

Note: The connector attached cable **CN-14A-C2** is supplied with the cable set type **FX-10□-CC2**.

M8 connector attached cable

• CN-24A-C□

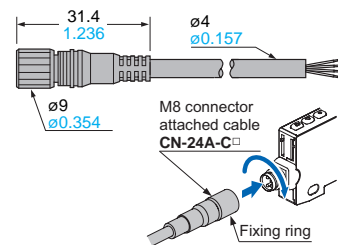

Amplifier mounting bracket

• MS-DIN-4

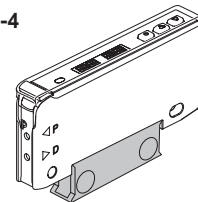

Connector attached cable

• CN-14A(-R)-C□

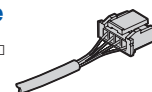

Connector

• CN-14A

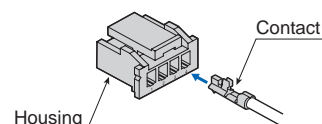

Recommended connector

Contact: SPHD-001T-P0.5, Housing: PAP-04V-S (Manufactured by J.S.T. Mfg. Co., Ltd.)

Note: Contact the manufacturer for details of the recommended products.

Recommended crimping tool

Model No.: YC-610R (Manufactured by J.S.T. Mfg. Co., Ltd.)

Note: Contact the manufacturer for details of the recommended products.

New product introduction
Tough Fiber

Fiber Selection Guide
Model

Choose by shape/application
How to read Model No.

Earlier models comparison table

Fibers

Super Quality

Threaded Type

Square Head Type

Cylindrical Type

Sleeve

Flat Type

Small Spot

Narrow Beam

Wide Beam

Convergent Reflective Type

Retroreflective Type

Chemical / Oil-resistant

Heat-resistant

Vacuum-resistant

Liquid Leak / Liquid Detection

Fiber Options

Semi-custom fibers

Fiber Dimensions

Thru-beam Type

Retroreflective Type

Reflective Type

Others

Amplifiers

FX-500 series

FX-100 series

INDEX

SPECIFICATIONS

Item	Model No.	Type	Standard type		Long sensing range type	
				Cable set		Cable set
		NPN output	FX-101(-Z) (Note 5)	FX-101-CC2	FX-102(-Z) (Note 5)	FX-102-CC2
		PNP output	FX-101P(-Z) (Note 5)	FX-101P-CC2	FX-102P(-Z) (Note 5)	FX-102P-CC2
Supply voltage			12 to 24 V DC $\pm 10\%$ Ripple P-P 10 % or less			
Power consumption			Normal operation: 720 mW or less (Current consumption 30 mA or less at 24 V supply voltage) ECO mode: 600 mW or less (Current consumption 25 mA or less at 24 V supply voltage)			
Output			<NPN output type> NPN open-collector transistor <ul style="list-style-type: none"> • Maximum sink current: 100 mA • Applied voltage: 30 V DC or less (between output and 0 V) • Residual voltage: 1.5 V or less (at 100 mA sink current) 		<PNP output type> PNP open-collector transistor <ul style="list-style-type: none"> • Maximum source current: 100 mA • Applied voltage: 30 V DC or less (between output and +V) • Residual voltage: 1.5 V or less (at 100 mA source current) 	
Output operation			Selectable either Light-ON or Dark-ON, at SET mode			
Short-circuit protection			Incorporated			
External input			<NPN output type> NPN non-contact input <ul style="list-style-type: none"> • Signal condition High: +8 V to +V DC or Open Low: 0 to +2 V DC (Source current 0.5 mA or less) • Input impedance: 10 kΩ approx. 		<PNP output type> PNP non-contact input <ul style="list-style-type: none"> • Signal condition High: +4 V to +V DC (Sink current 0.5 to 3 mA) Low: 0 to +0.6 V DC or Open • Input impedance: 10 kΩ approx. 	
Response time			Emission frequency 0: 250 μ s or less (factory default setting) Emission frequency 1: 450 μ s or less Emission frequency 2: 500 μ s or less Emission frequency 3: 600 μ s or less		Emission frequency 1: 2.5 ms or less (factory default setting) Emission frequency 2: 2.8 ms or less Emission frequency 3: 3.2 ms or less Emission frequency 4: 5.0 ms or less	
Sensitivity setting			2-point teaching / Limit teaching / Full-auto teaching			
Operation indicator			Orange LED (lights up when the output is ON)			
Digital display			4 digits (green) + 4 digits (red) LCD display			
Fine sensitivity adjustment function			Incorporated			
Timer function			ON-delay / OFF-delay timer, switchable either effective or ineffective [Timer period: 1 ms, 5 ms, 10 ms, 20 ms, 40 ms, 50 ms, 100 ms, 500 ms, 1,000 ms]			
Emission amount setting function			3-level + Auto setting (from production in December 2007)			
Interference prevention function			Incorporated Emission frequency selection method (Note 2) (Functions at emission frequency 1, 2 or 3)		Incorporated Emission frequency selection method (Note 2) (Functions at emission frequency 1, 2, 3 or 4)	
Environmental resistance	Ambient temperature		-10 to +55 °C +14 to +131 °F (If 4 to 7 units are mounted close together: -10 to +50 °C +14 to +122 °F, if 8 to 16 units are mounted close together: -10 to +45 °C +14 to +113 °F) (No dew condensation or icing allowed), Storage: -20 to +70 °C -4 to +158 °F			
	Ambient humidity		35 to 85 % RH, Storage: 35 to 85 % RH			
	Ambient illuminance		Incandescent light: 3,000 lx at the light-receiving face			
	Voltage withstandability		1,000 V AC for one min. between all supply terminals connected together and enclosure (Note 3)			
	Insulation resistance		20 M Ω , or more, with 250 V DC megger between all supply terminals connected together and enclosure (Note 3)			
	Vibration resistance		10 to 150 Hz frequency, 0.75 mm 0.030 in amplitude in X, Y and Z directions for two hours each			
	Shock resistance		98 m/s ² acceleration (10 G approx.) in X, Y and Z directions for five times each			
Emitting element (modulated)			Red LED (Peak emission wavelength: 643 nm 0.025 mil)			
Material			Enclosure: Polycarbonate, Key switch: Polycarbonate, Fiber lock lever: PBT			
Connecting method			Connector (Note 4)			
Cable length			Total length up to 100 m 328.084 ft is possible with 0.3 mm ² , or more, cable.			
Weight			Net weight: 15 g approx. Gross weight: 35 g approx.	Net weight: 15 g approx. Gross weight: 75 g approx.	Net weight: 15 g approx. Gross weight: 35 g approx.	Net weight: 15 g approx. Gross weight: 75 g approx.
Accessory			FC-FX-1 (Protection cover): 1 pc. (Note 6)	FC-FX-1 (Protection cover): 1 pc. (Note 6) CN-14A-C2 (Connector attached cable, 2 m 6.562 ft long): 1 pc.	FC-FX-1 (Protection cover): 1 pc. (Note 6)	FC-FX-1 (Protection cover): 1 pc. (Note 6) CN-14A-C2 (Connector attached cable, 2 m 6.562 ft long): 1 pc.

Notes: 1) Where measurement conditions have not been specified precisely, the conditions used were an ambient temperature of +23 °C +73.4 °F.

2) When using the interference prevention function, set the emission frequencies for the amplifiers to be covered by the interference prevention function to different frequency values.

However, the interference prevention function does not operate at emission frequency 0 (factory default setting) for the **FX-101(P)(-Z)** / **FX-101(P)-CC2**.

3) The voltage withstandability and the insulation resistance values given in the above table are for the amplifier only.

4) Connector attached cable **CN-14A-C2** is not attached to the models that have no "-CC2" at the end of the model Nos.

Make sure to use the optional connector attached cable **CN-14A(-R)-C** or the connector **CN-14A**, or a connector manufactured by J.S.T. Mfg., Ltd. (contact: SPHD-001T-P0.5, housing: PAP-04V-S).

5) Model Nos. having the suffix "-Z" are M8 plug-in connector type. Make sure to use the optional M8 attached connector cable **CN-24A-C**.

6) Protection cover **FC-FX-1** has been attached from production in July, 2011.

New product introduction
Tough Fiber

Fiber Selection Guide

Model

Choose by shape/application

How to read Model No.

Earlier models comparison table

Fibers

Super Quality

Threaded Type

Square Head Type

Cylindrical Type

Sleeve

Flat Type

Small Spot

Narrow Beam

Wide Beam

Convergent Reflective Type

Retroreflective Type

Chemical / Oil-resistant

Heat-resistant

Vacuum-resistant

Liquid Leak / Liquid Detection

Fiber Options

Semi-custom fibers

Fiber Dimensions

Thru-beam Type

Retroreflective Type

Reflective Type

Others

Amplifiers

FX-500 series

FX-100 series

INDEX

I/O CIRCUIT AND WIRING DIAGRAMS

FX-10□(-Z/-CC2)

NPN output type

I/O circuit diagram

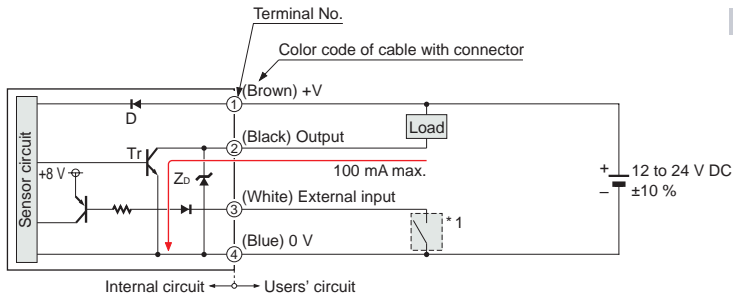

Terminal arrangement diagram

Connector type

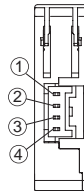

Terminal No.	Function
①	+V
②	Output
③	External input
④	0 V

M8 plug-in connector type

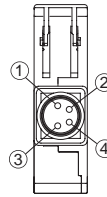

Terminal No.	Function
①	+V
②	Output
③	External input
④	0 V

Symbols ... D : Reverse supply polarity protection diode
 Z_D: Surge absorption zener diode
 Tr : NPN output transistor

* 1

Non-voltage contact or NPN open-collector transistor

High (+8 V to +V DC, or open): Ineffective
 Low [0 to +2 V DC (source current 0.5 mA or less)]: Effective

FX-10□P(-Z/-CC2)

PNP output type

I/O circuit diagram

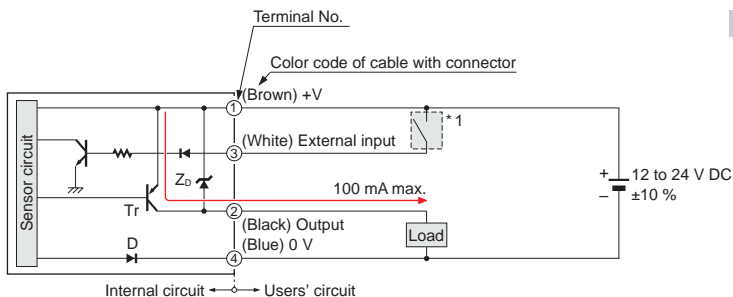

Terminal arrangement diagram

Connector type

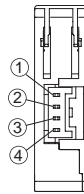

Terminal No.	Function
①	+V
②	Output
③	External input
④	0 V

M8 plug-in connector type

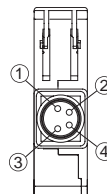

Terminal No.	Function
①	+V
②	Output
③	External input
④	0 V

Symbols ... D : Reverse supply polarity protection diode
 Z_D: Surge absorption zener diode
 Tr : PNP output transistor

* 1

Non-voltage contact or PNP open-collector transistor

High [+4 V to +V DC (sink current 0.5 to 3 mA)]: Effective
 Low (0 to +0.6 V DC, or open): Ineffective

- New product introduction
- Tough Fiber
- Fiber Selection Guide
- Model
- Choose by shape/application
- How to read Model No
- Earlier models comparison table
- Fibers
- Super Quality
- Threaded Type
- Square Head Type
- Cylindrical Type
- Sleeve
- Flat Type
- Small Spot
- Narrow Beam
- Wide Beam
- Convergent Reflective Type
- Retroreflective Type
- Chemical / Oil-resistant
- Heat-resistant
- Vacuum-resistant
- Liquid Leak / Liquid Detection
- Fiber Options
- Semi-custom fibers
- Fiber Dimensions
- Thru-beam Type
- Retroreflective Type
- Reflective Type
- Others
- Amplifiers
- FX-500 series
- FX-100 series
- INDEX

SENSING CHARACTERISTICS (TYPICAL)

FT-31S Thru-beam type

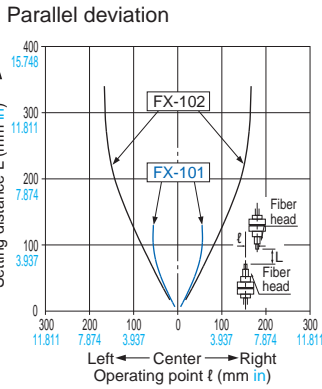

FT-31W Thru-beam type

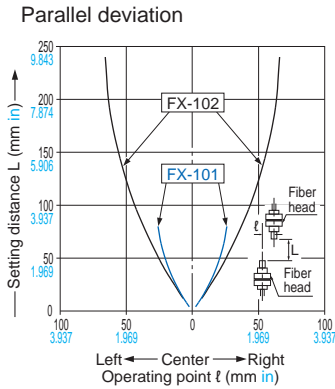

FT-42S Thru-beam type

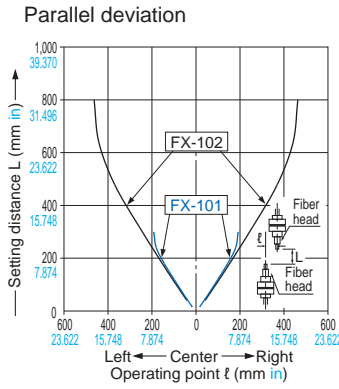

FT-42W Thru-beam type

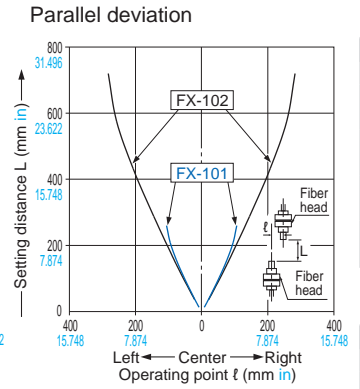

FT-43 Thru-beam type

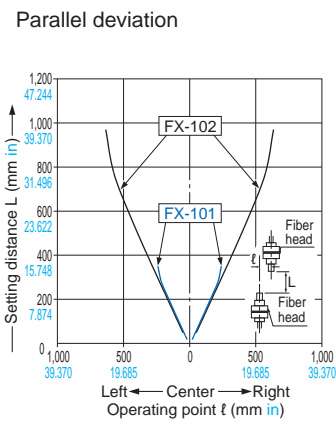

FT-45X Thru-beam type

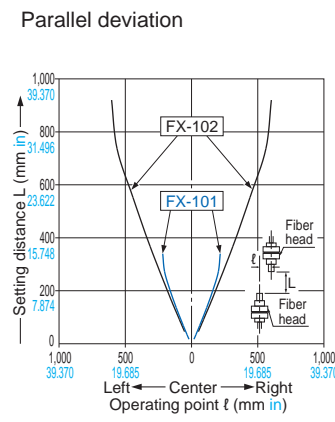

FT-A11 Thru-beam type

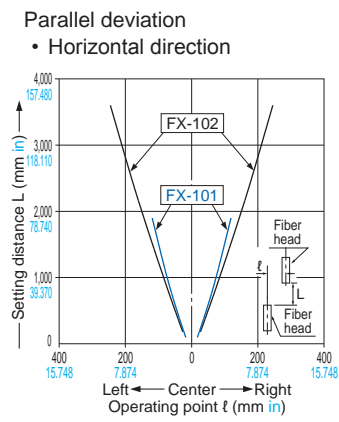

FT-A11 Thru-beam type

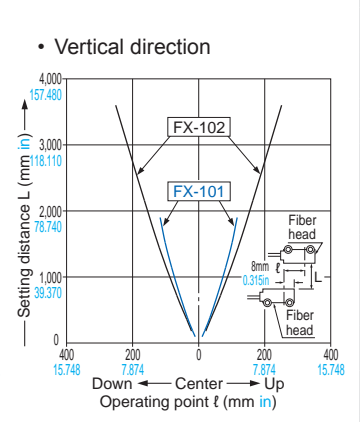

FT-S21W Thru-beam type

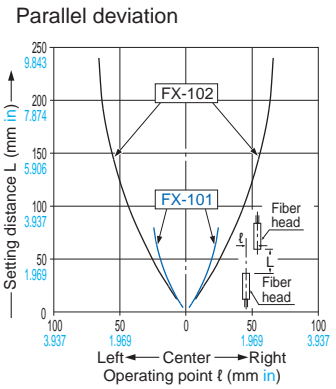

FT-S31W Thru-beam type

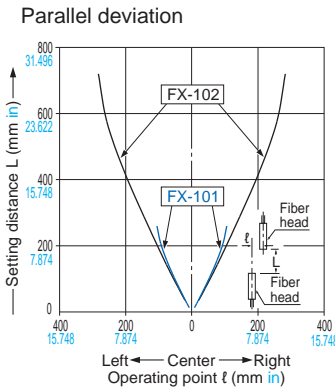

FD-32G Reflective type

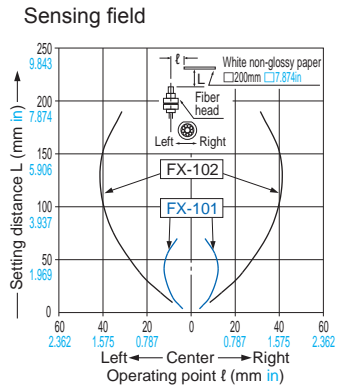

FD-32GX Reflective type

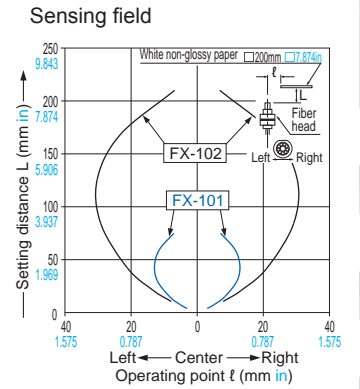

FD-41S Reflective type

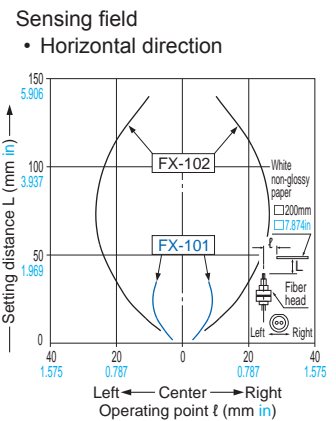

FD-41W Reflective type

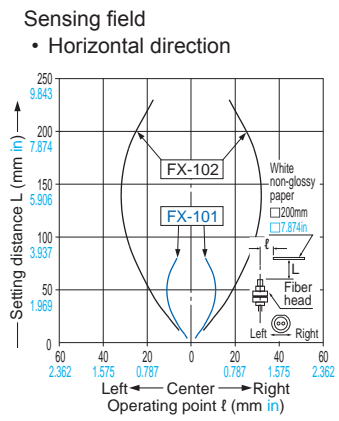

FD-41W Reflective type

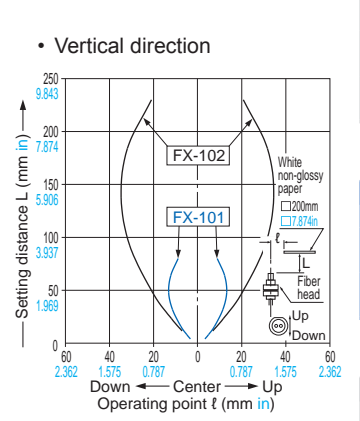

New product introduction
Tough Fiber

Fiber Selection Guide

Model

Choose by shape/application

How to read Model No.

Earlier models comparison table

Fibers

Super Quality

Threaded Type

Square Head Type

Cylindrical Type

Sleeve

Flat Type

Small Spot

Narrow Beam

Wide Beam

Convergent Reflective Type

Retroreflective Type

Chemical / Oil-resistant

Heat-resistant

Vacuum-resistant

Liquid Leak / Liquid Detection

Fiber Options

Semi-custom fibers

Fiber Dimensions

Thru-beam Type

Retroreflective Type

Reflective Type

Others

Amplifiers

FX-500 series

FX-100 series

INDEX

SENSING CHARACTERISTICS (TYPICAL)

FD-42G Reflective type

Sensing field

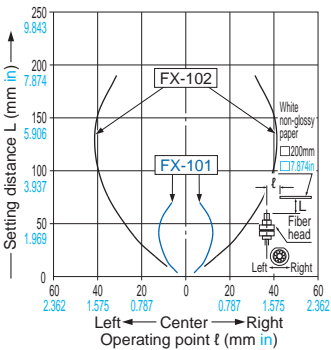

FD-42GW Reflective type

Sensing field

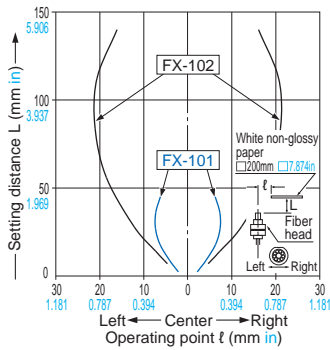

FD-61G Reflective type

Sensing field

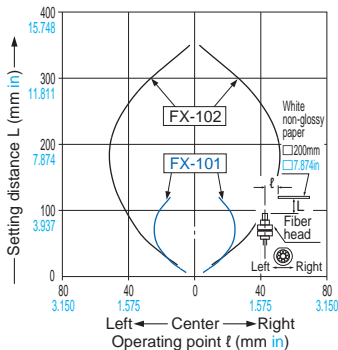

FD-61W Reflective type

Sensing field

• Horizontal direction

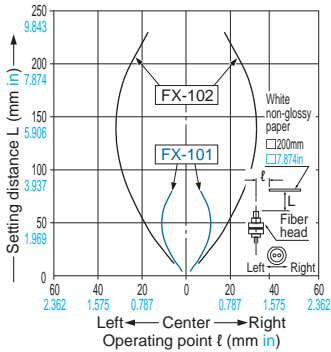

• Vertical direction

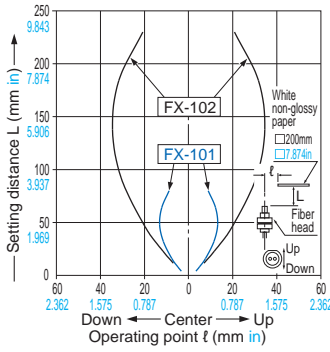

FD-62 Reflective type

Sensing field

• Horizontal direction

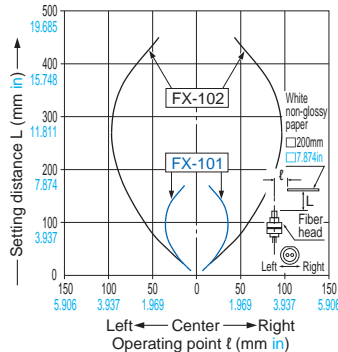

• Vertical direction

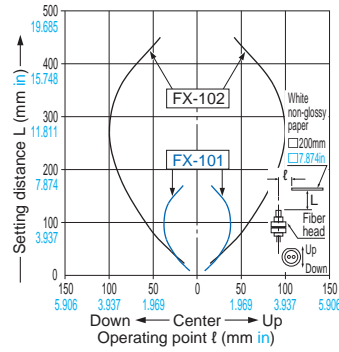

FD-64X Reflective type

Sensing field

• Horizontal direction

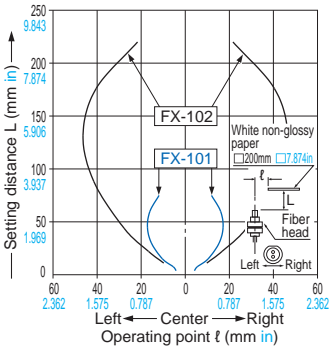

• Vertical direction

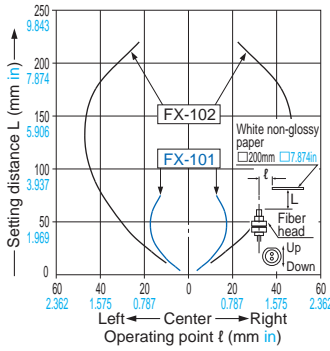

FD-S32W Reflective type

Sensing field

• Horizontal direction

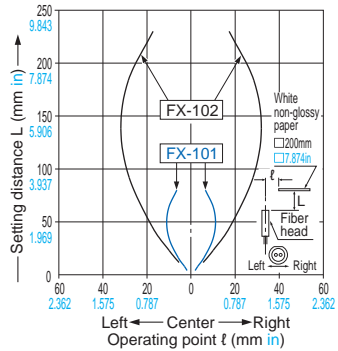

• Vertical direction

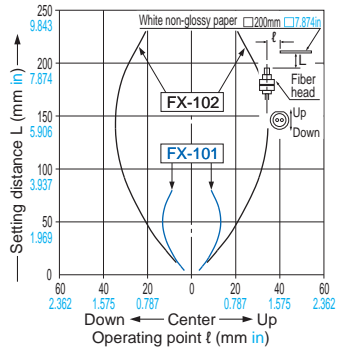

FD-S33GW Reflective type

Sensing field

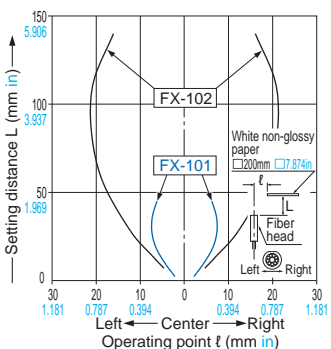

Fiber Selection Guide
Model
Choose by shape/application
How to read Model No
Earlier models comparison table

Fibers
Super Quality
Threaded Type
Square Head Type
Cylindrical Type
Sleeve
Flat Type
Small Spot
Narrow Beam
Wide Beam
Convergent Reflective Type
Retroreflective Type
Chemical / Oil-resistant
Heat-resistant
Vacuum-resistant
Liquid Leak / Liquid Detection

Fiber Options
Semi-custom fibers
Fiber Dimensions
Thru-beam Type
Retroreflective Type
Reflective Type
Others

Amplifiers
FX-500 series
FX-100 series

INDEX

PRECAUTIONS FOR PROPER USE



- Never use this product as a sensing device for personnel protection.
- In case of using sensing devices for personnel protection, use products which meet laws and standards, such as OSHA, ANSI or IEC etc., for personnel protection applicable in each region or country.

Using in combination with the FX-300 / FX-410 series

- The **FX-100** series does not use the horizontal connectors that are used with the **FX-300 / FX-410** series. Please note that horizontal connection cannot be performed using a connector attached cable. In addition, the optical communication function is not equipped on the **FX-100** series, so it is unable to perform interference prevention for use with the **FX-300 / FX-410** series. If using the **FX-100** series together with the **FX-300 / FX-410** series side-by-side, please set the same models together in groups.

Mounting

<When using a DIN rail>

How to mount the amplifier

- ① Fit the rear part of the mounting section of the amplifier on a 35 mm **1.378 in** width DIN rail.
- ② Press down the rear part of the mounting section of the unit on the 35 mm **1.378 in** width DIN rail and fit the front part of the mounting section to the DIN rail.

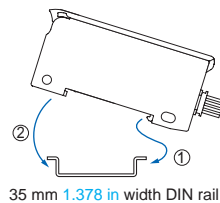

How to remove the amplifier

- ① Push the amplifier forward.
- ② Lift up the front part of the amplifier to remove it.

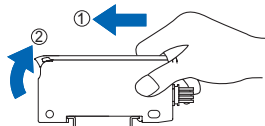

Note: Take care that if the front part is lifted without pushing the amplifier forward, the hook on the rear portion of the mounting section is likely to break.

<When using screws with washers>

- Use M3 screws with washers for mounting. The tightening torque should be 0.5 N·m or less.

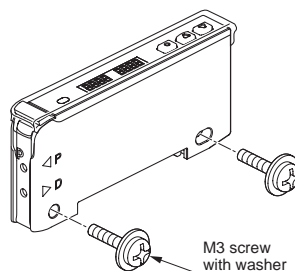

Refer to the "Operation Guide" on our website for details pertaining to operating instructions for the amplifier.

Wiring

- Make sure that the power supply is OFF while adding or removing the amplifiers.
- Note that if a voltage exceeding the rated range is applied, or if an AC power supply is directly connected, the product may get burnt or damaged.
- Note that short-circuit of the load or wrong wiring may burn or damage the product.
- Do not run the wires together with high-voltage lines or power lines, or put them in the same raceway. This can cause malfunction due to induction.
- Verify that the supply voltage variation is within the rating.
- If power is supplied from a commercial switching regulator, ensure that the frame ground (F.G.) terminal of the power supply is connected to an actual ground.
- In case noise generating equipment (switching regulator, inverter motor, etc.) is used in the vicinity of this product, connect the frame ground (F.G.) terminal of the equipment to an actual ground.
- Make sure to use the quick-connection cable (optional) for the connection of the controller. Extension up to total 100 m **328.084 ft** is possible with 0.3 mm² or more, cable. However, in order to reduce noise, make the wiring as short as possible.

Part description

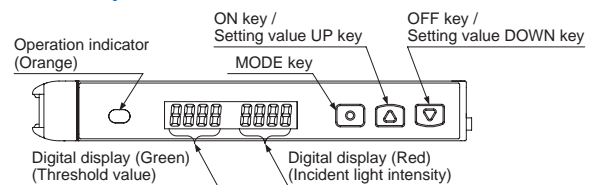

Setting mode

- Setting mode appears after the MODE key is pressed for 2 sec. in RUN mode.

Setting item	Factory setting	Description
Teaching mode	LRch	Threshold value can be set in 2-point teaching, limit teaching, or full-auto teaching.
Output operation setting	L_d d_on [Dark-ON]	Light-ON or Dark-ON can be set.
Timer operation setting	dELY non [Without timer]	Without timer, ON delay timer, or OFF delay timer can be set.
Timer delays setting	ond 10 [ON-delay timer: 10 ms] ofd 10 [OFF-delay timer: 10 ms]	When setting ON delay timer or OFF delay timer in the timer operation setting mode, timer delays can be set. • When timer is not set, this mode is not displayed.
Emission amount setting	PctL IIII * [Level 3]	In case incident light intensity is saturated, emission amount can be reduced.
Emission frequency setting	FX-101□ FrE9 F-0 [0 (Response time: 250 μs or less)] FX-102□ FrE9 F-01 [1 (Response time: 2.5 ms or less)]	When using the fiber heads in parallel, interference can be prevented by setting different emission frequency. However, when emission frequency 0 is set, interference cannot be prevented. Response time corresponds to emission frequency.

* Indicated as "PctL off" before production in November 2007.

New product introduction
Tough Fiber

Fiber Selection Guide

Model

Choose by shape/application

How to read Model No.

Earlier models comparison table

Fibers

Super Quality

Threaded Type

Square Head Type

Cylindrical Type

Sleeve

Flat Type

Small Spot

Narrow Beam

Wide Beam

Convergent Reflective Type

Retroreflective Type

Chemical / Oil-resistant

Heat-resistant

Vacuum-resistant

Liquid Leak / Liquid Detection

Fiber Options

Semi-custom fibers

Fiber Dimensions

Thru-beam Type

Retroreflective Type

Reflective Type

Others

Amplifiers

FX-500 series

FX-100 series

INDEX

PRECAUTIONS FOR PROPER USE

PRO mode

- PRO mode appears after the MODE key is pressed for 4 sec. in RUN mode.

Setting item	Factory setting	Description
Shift setting	(Shift amount 15%)	Shift amount can be selected from 0 to 80 % in the limit teaching. Select 0 % when it is desired to set the present incident light intensity as a threshold value.
External input setting	(Emission halt)	External input can be selected from emission halt, limit teaching [+], limit teaching [-], full-auto teaching, ECO (Note 1), 2-point teaching or emission amount test. When setting the incident light intensity test "LESt", output turns ON / OFF every 100ms when the rate of incident light intensity and threshold value is less than half of the set shift amount (for example, when the rate of incident light intensity and threshold value is within ± 10 % for 20 % of shift amount) at external input.
Threshold value-storing setting mode (Note 2)	(OFF)	Threshold value set at the limit teaching, full-auto teaching or 2-point teaching by external input is stored. When selecting Auto in the emission amount setting mode, the set emission amount level is also stored.
Threshold value follow-up cycle setting (Note 3)	(OFF)	When incident light intensity exceeds threshold value, this mode can change the threshold value with each set cycle depending on variations of the incident light intensity. The follow-up shift amount is same as the one set in the shift setting mode. However, the threshold value is not stored.
GETA function setting (Note 4, 5)	(OFF)	Variations can be reduced by correcting the present incident light intensity in each amplifier to a target value. Target value to offset incident light intensity can be selected from 0 to 2,000 by 100 unit each. For example, if the target value is set to 2,000 when the incident light intensity is 1,500, the incident light intensity becomes 2,000.
ECO setting	(OFF)	It is possible to light up / turn off the digital display. When ECO setting mode is ON, the display turns off in 20 sec. approx. in RUN mode. To light up the display again, press any key for 2 sec. or more.
Digital display inversion setting	(OFF)	Digital display can be inverted.
Threshold value margin setting	(OFF)	Margin for threshold value to the present incident light intensity can be checked. When there is no margin, it is possible to make the digital display blink. off : Set to "OFF": does not function. Grn : Green blinks. Red : Red blinks. RL : Red and green blink. In-t : When conducting limit teaching or 2-point teaching by external input, in case the rate of reference incident light intensity and threshold value after teaching is 200% or more, or in case it is less than half of the shift amount, output turns ON / OFF every 100 ms. (Note 6)
Setting copy	(NO)	The settings of the master side amplifier can be copied to the slave side amplifier. For details, refer to "Setting copy function".
Reset	(NO)	Returns to default settings (factory settings.)

- Notes: 1) When ECO is selected at the external input setting mode, key operation on the main body is invalid during external input.
2) This mode is not indicated unless any of "LEcP", "LEc-", "Auto" or "2-Pl" is set at the external input setting mode. (Incorporated from production in December 2007.)
3) If the incident light intensity becomes "300" or less, the follow-up operation stops. In that condition, threshold value [digital display (green)] blinks. This function can be used when thru-beam type or retroreflective type fiber is applied to this product. If reflective type fiber is applied, the function cannot be used depending on use conditions.
4) If MODE key is pressed in RUN mode when GETA function is used, the incident light intensity before setting GETA function is displayed on the red digital display for 2 sec. approx.
5) When GETA function is used in saturation of incident light intensity (4,000 or more,) "HARD" is indicated on the red digital display. Correction value is up to 4,000.
6) This mode does not operate unless any of "LEcP", "LEc-" or "2-Pl" is set at the external input setting mode. (Incorporated from production in December 2007.)

Refer to the "Operation Guide" on our website for details pertaining to operating instructions for the amplifier.

Setting copy function

- This can copy the settings of the master side amplifier to the slave side amplifier.

- Be sure to use the setting copy function between the identical models (Between FX-101□ models or FX-102□ models). This function cannot be used between different models.
- Only one sensor can be connected on slave side with a master side sensor for the setting copy function.
- Threshold value, output operation setting, timer operation setting, timer setting, light-emitting amount setting, shift setting, external input setting, threshold value margin setting, ECO setting, digital display inversion setting, and threshold value margin setting can be copied.

<Setting procedures>

- Set the setting copy mode of the master side amplifier to "Copy sending ON", and press the MODE key so that "COPY rEdy" is shown on the digital display and the sensor is in copy ready state. For the setting method, refer to "Operation guide".
- Turn off the master side amplifier.
- Connect the master side amplifier with the slave side amplifier as shown below.

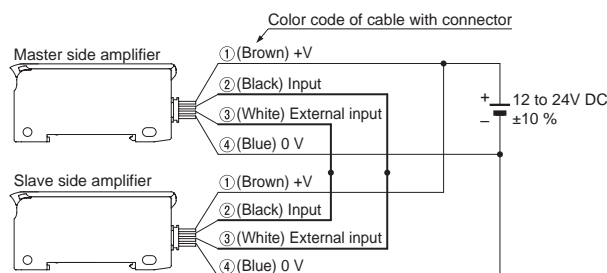

- Turn on the master side amplifier and the slave side amplifier at the same time. (Note)
- "COPY" is shown on the green digital display of the master side amplifier and 4-digit code is shown on the red digital display of it, then the copying starts. During copy communication, "COPY" is shown on the green digital display of the slave side amplifier, and the ongoing copy communication indicator ("!" → "!!" → "!!!" → "!!!!" → "!!!!!" → "!!!!!!" → "!!!!!!!") is displayed on the red digital display.
- When the copying is completed, "Good" is shown on the green digital display of the slave side amplifier, while the 4-digit code (the same code as the master side amplifier) is shown on the red digital display of it.
- Turn off the power of the master side amplifier and the slave side amplifier and disconnect the wire.

* If copying the settings to another amplifier repeatedly, follow the steps ③ to ⑦.

Note: Take care that if the power is not turned on at the same time, the setting contents may not be copied.

<To cancel the setting copy mode of the master side amplifier>

- While the slave side amplifier is disconnected, turn on the power of the master side amplifier.
- Press the MODE key for 2 sec. approx.

PRECAUTIONS FOR PROPER USE

Others

- Our products have been developed / produced for industrial use only.
- Do not use during the initial transient time (0.5 sec.) after the power supply is switched on.
- Take care that the product is not directly exposed to fluorescent lamp from a rapid-starter lamp, a high frequency lighting device or sunlight etc., as it may affect the sensing performance.
- This product is suitable for indoor use only.
- Avoid dust, dirt, and steam.
- Take care that the product does not come in contact with oil, grease, organic solvents, such as thinner, etc., strong acid or alkaline.
- This product cannot be used in an environment containing inflammable or explosive gases.
- Never disassemble or modify this product.
- EEPROM is adopted to this product. It is not possible to conduct teaching 100 thousand times or more, because of the EEPROM's lifetime.

Quick setting function

- The quick setting function makes it possible to set the content of the SET Mode (output operation, timer operation, amount of light emitted, and frequency of light emitted) simply by selecting a setting number.
- While in the RUN Mode, pressing and holding both the ON key (▲) and OFF key (▼) simultaneously for 2 seconds will switch to the quick setting function.

<Table of quick setting numbers>

No.	Output operation	Timer	Emission amount setting (Note)
-00-	D-ON	non	Level 3 (OFF)
-01-	D-ON	non	Level 2 (ON)
-02-	D-ON	ofd 10 ms	Level 3 (OFF)
-03-	D-ON	ofd 10 ms	Level 2 (ON)
-04-	D-ON	ofd 40 ms	Level 3 (OFF)
-05-	D-ON	ofd 40 ms	Level 2 (ON)
-06-	D-ON	ond 10 ms	Level 3 (OFF)
-07-	D-ON	ond 10 ms	Level 2 (ON)
-08-	D-ON	ond 40 ms	Level 3 (OFF)
-09-	D-ON	ond 40 ms	Level 2 (ON)
-10-	L-ON	ond 40 ms	Level 2 (ON)
-11-	L-ON	ond 40 ms	Level 3 (OFF)
-12-	L-ON	ond 10 ms	Level 2 (ON)
-13-	L-ON	ond 10 ms	Level 3 (OFF)
-14-	L-ON	ofd 40 ms	Level 2 (ON)
-15-	L-ON	ofd 40 ms	Level 3 (OFF)
-16-	L-ON	ofd 10 ms	Level 2 (ON)
-17-	L-ON	ofd 10 ms	Level 3 (OFF)
-18-	L-ON	non	Level 2 (ON)
-19-	L-ON	non	Level 3 (OFF)

Note: Until production in November 2007, OFF or ON was selectable. The emission amount of Level 2 (ON) is about 40% of that of Level 3 (OFF).

Difference between previous model and upgraded one

- For upgraded ones (production in and after December 2007), "P" is marked near the beam-emitting inlet. Previous ones have no marking. Appearance and functions have been changed.

<After upgrade>

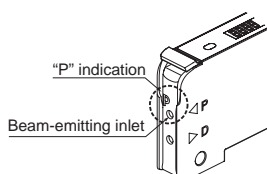

<Previous>

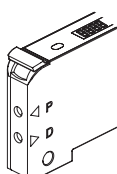

Refer to the "Operation Guide" on our website for details pertaining to operating instructions for the amplifier.

Code setting function

- The code setting function makes it possible to set the output operation, timer operation, amount of light emitted, frequency of light emitted, ECO setting, external input, and amount of shift by selecting a code of one's choice.
- While in the RUN Mode, pressing and holding both the ON key (▲) and OFF key (▼) simultaneously for 4 seconds will switch to the code setting function.

<Code table>

Code 0002

Code	1st digit		2nd digit		ECO	External input	Shift (Note 1)	
	Output operation	Timer (Note 1)	Emission amount setting (Note 2)					
			FX-101□	FX-102□				
0	D-ON	non	0	1	OFF	Emission halt	5 %	
1		ond 10 ms	1	2		Limit teaching [+]	10 %	
2		ond 40 ms	2	3		Limit teaching [-]	15 %	
3		ofd 10 ms	3	4		Full-auto teaching	20 %	
4		ofd 40 ms	0	1		ECO	25 %	
5	L-ON	non	1	2	ON	Emission halt	30 %	
6		ond 10 ms	2	3		Limit teaching [+]	35 %	
7		ond 40 ms	3	4		Limit teaching [-]	40 %	
8		ofd 10 ms	0	1		Full-auto teaching	45 %	
9		ofd 40 ms	1	2		ECO	50 %	
A	Auto		2	3	OFF	2-point teaching		
B			3	4		Incident light intensity test		
C			0	1		ON		2-point teaching
D			1	2				Incident light intensity test
E			2	3				
F			3	4				

- Notes: 1) When the present setting is out of the code setting range, "-" is shown. When "-" is selected, the set content of the digit is not changed.
 2) Until production in November 2007, OFF or ON was selectable. The emission amount of Level 2 is about 40% of that of Level 3. The emission amount of Level 1 is about 20% of that of Level 3.
 3) The factory setting is "0002".

New product introduction
Tough Fiber

Fiber Selection Guide

Model

Choose by shape/application

How to read Model No.

Earlier models comparison table

Fibers

Super Quality

Threaded Type

Square Head Type

Cylindrical Type

Sleeve

Flat Type

Small Spot

Narrow Beam

Wide Beam

Convergent Reflective Type

Retroreflective Type

Chemical / Oil-resistant

Heat-resistant

Vacuum-resistant

Liquid Leak / Liquid Detection

Fiber Options

Semi-custom fibers

Fiber Dimensions

Thru-beam Type

Retroreflective Type

Reflective Type

Others

Amplifiers

FX-500 series

FX-100 series

INDEX

DIMENSIONS (Unit: mm in)

FX-101□ FX-102□ Amplifier

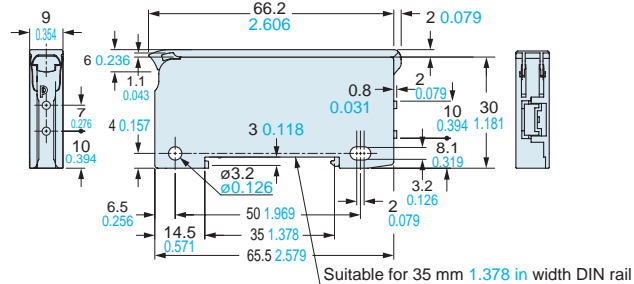
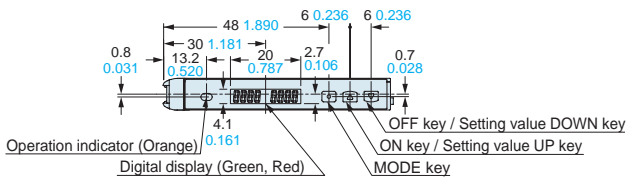

Note: The protection cover has been attached from the production at July, 2011.

FX-101(P)-Z FX-102(P)-Z Amplifier

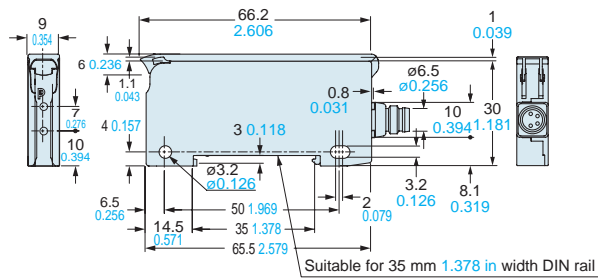
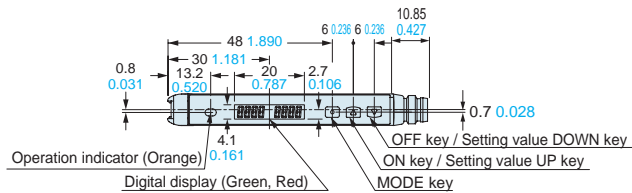

Note: The protection cover has been attached from the production at July, 2011.

MS-DIN-4 Amplifier mounting bracket (Optional)

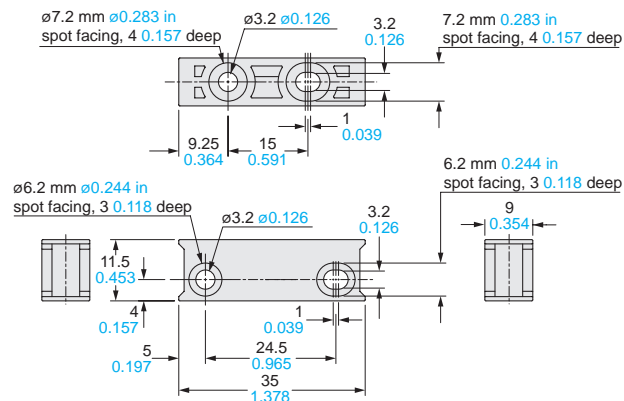

Material: PBT

Previous dimensions (production before November 2007)

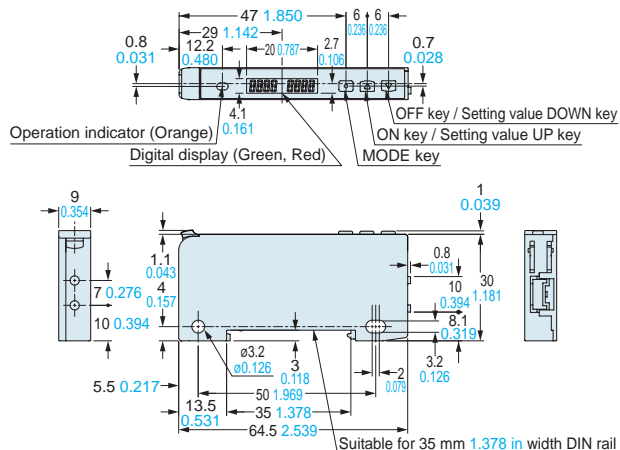

CN-14A-C□ CN-14A-R-C□ Connector attached cable (Optional)

CN-14A-C2 is attached FX-101(P)-CC2 / FX-102(P)-CC2

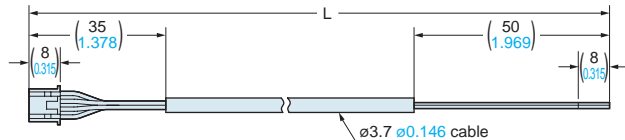

• Length L

Model No.	Length L
CN-14A(-R)-C1	1,000 39.370
CN-14A(-R)-C2	2,000 78.740
CN-14A(-R)-C3	3,000 118.110
CN-14A(-R)-C5	5,000 196.850

MS-DIN-E End plate (Optional)

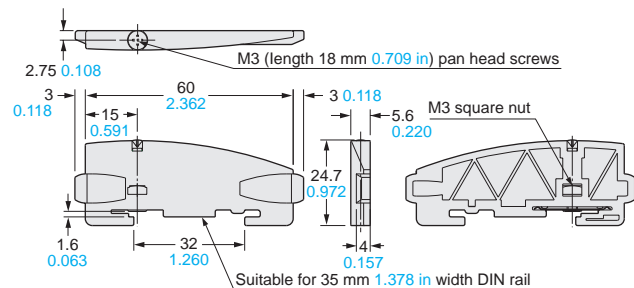

Material: Polycarbonate

INDEX

C		
CN-14A	FX-100 Connector	p.102
CN-14A-C1		p.102/p.110
CN-14A-C2	FX-100 Connector Attached Cable	p.102/p.103/ p.110
CN-14A-C3		p.102/p.110
CN-14A-C5		
CN-14A-R-C1		p.102/p.110
CN-14A-R-C2	FX-100 Connector Attached Cable (Flexible)	
CN-14A-R-C3		
CN-14A-R-C5		
CN-71-C1		p.74/p.96
CN-71-C2		
CN-71-C5		
CN-72-C1		
CN-72-C2		
CN-72-C5	FX-500 Quick-connection Cable	
CN-73-C1		
CN-73-C2		
CN-73-C5		
CN-74-C1		
CN-74-C2		
CN-74-C5		

F		
FB-1	Fiber Bender	p.18/p.45/p.66
FC-FX-1	FX-100 Protection Cover	p.102/p.103
FD-30	Super Quality Fiber	p.11/p.39/p.56/ p.85
FD-31	Threaded Type Fiber	p.13/p.39/p.56/ p.85
FD-31W		
FD-32G	Threaded / Small Spot Type Fiber	p.13/p.23/p.39/ p.56/p.85/p.105
FD-32GX		
FD-40	Super Quality Fiber	p.11/p.39/p.56/ p.86
FD-41	Threaded Type Fiber	p.13/p.39/p.56/ p.86
FD-41S	Sleeve Fiber	p.19/p.39/p.56/ p.86/p.105
FD-41SW		
FD-41W	Threaded Type Fiber	p.13/p.39/p.56/ p.86/p.105
FD-42G	Threaded / Small Spot Type Fiber	p.13/p.23/p.39/ p.57/p.86/p.106
FD-42GW		
FD-60	Super Quality Fiber	p.11/p.39/p.57/ p.86
FD-61	Threaded Type Fiber	p.13/p.39/p.57/ p.87
FD-61G		
FD-61S	Sleeve Fiber	p.19/p.39/p.57/ p.87
FD-61W	Threaded Type Fiber	p.13/p.39/p.57/ p.87/p.106
FD-62		
FD-64X		p.13/p.39/p.58/ p.87/p.106
FD-A16	Wide Beam Fiber	p.25/p.39/p.58/ p.87
FD-AL11		

FD-E13	Cylindrical / Sleeve Fiber	p.17/p.19/p.39/ p.58/p.88
FD-E23		
FD-EG30	Threaded / Small Spot Type Fiber	p.13/p.23/p.39/ p.58/p.88
FD-EG30S	Sleeve Fiber	p.19/p.39/p.59/ p.88
FD-EG31	Threaded / Small Spot Type Fiber	p.13/p.23/p.39/ p.59/p.88
FD-F4	Liquid Leak / Liquid Detection Fiber	p.35/p.39/p.59
FD-F41		
FD-F41Y		
FD-F71		
FD-F8Y		
FD-FA93		
FD-H13-FM2	Heat-resistant Fiber	p.31/p.40/p.60/ p.88
FD-H18-L31		
FD-H20-21		
FD-H20-M1		
FD-H25-L43	Vacuum-resistant Fiber	p.31/p.40/p.60/ p.89
FD-H25-L45		
FD-H30-KZ1V	Heat-resistant Fiber	p.33/p.44 p.32/p.40/p.61
FD-H30-KZ1V-S		
FD-H30-L32	Heat-resistant Fiber	p.31/p.40/p.61/ p.89
FD-H30-L32V		
FD-H30-L32V-S	Vacuum-resistant Fiber	p.32/p.40/p.61/ p.89
FD-H35-20S	Heat-resistant Fiber	p.31/p.40/p.61/ p.89
FD-H35-M2		
FD-H35-M2S6		
FD-HF40Y	Liquid Leak / Liquid Detection Fiber	p.35/p.40/p.61
FD-L10	Convergent Reflective Type Fiber	p.26/p.40/p.62/ p.89
FD-L11		
FD-L12W		
FD-L20H		
FD-L21		
FD-L21W		
FD-L22A		
FD-L23		
FD-L30A		
FD-L31A		
FD-L32H		p.26/p.40/p.63/ p.90
FD-R31G	Square Head / Small Spot Type Fiber	p.15/p.23/p.40/ p.63
FD-R32EG		
FD-R33EG		
FD-R34EG	Square Head type Fiber	p.15/p.40/p.63
FD-R41		
FD-R60	Threaded Type Fiber	p.13/p.40/p.63/ p.90
FD-R61Y	Square Head / Chemical / Oil-resistant Fiber	p.15/p.29/p.40/ p.91
FD-S21	Cylindrical Fiber	p.17/p.40/p.63/ p.91
FD-S30	Super Quality Fiber	p.11/p.40/p.64/ p.91
FD-S31	Cylindrical Fiber	p.17/p.40/p.64/ p.91
FD-S32		
FD-S32W		
FD-S33GW		
FD-S60Y	Chemical / Oil-resistant Fiber	p.29/p.41/p.64/ p.91

New product introduction

Tough Fiber

Fiber Selection Guide

Model

Choose by shape/application

How to read Model No

Earlier models comparison table

Fibers

Super Quality

Threaded Type

Square Head Type

Cylindrical Type

Sleeve

Flat Type

Small Spot

Narrow Beam

Wide Beam

Convergent Reflective Type

Retroreflective Type

Chemical / Oil-resistant

Heat-resistant

Vacuum-resistant

Liquid Leak / Liquid Detection

Fiber Options

Semi-custom fibers

Fiber Dimensions

Thru-beam Type

Retroreflective Type

Reflective Type

Others

Amplifiers

FX-500 series

FX-100 series

INDEX

INDEX

FD-V30	Sleeve Fiber	p.19/p.41/p.64/ p.92
FD-V30W		
FD-V50		p.19/p.41/p.65/ p.92
FD-Z20HBW	Flat Type Fiber	p.21/p.41/p.65/ p.92
FD-Z20W		
FD-Z40HBW		p.21/p.41/p.65/ p.92
FD-Z40W		
FD-Z50HW	Narrow Beam Fiber	p.24/p.41/p.65/ p.92
FDP-1000	Protective Tube (For Reflective Type Fiber)	p.45/p.67
FDP-1500		
FDP-500		
FDP-N1000		
FDP-N1500		
FDP-N500		
FR-KZ22E	Narrow Beam / Retroreflective Type Fiber	p.24/p.27/p.38/ p.55/p.84
FR-KZ50E		
FR-KZ50H		p.24/p.27/p.38/ p.55/p.85
FR-Z50HW		p.24/p.27/p.38/ p.55/p.85
FT-140	Threaded Type Fiber	p.12/p.36/p.48/ p.79
FT-30	Super Quality Fiber	p.11/p.36/p.48/ p.79
FT-31	Threaded Type Fiber	p.12/p.36/p.48/ p.79
FT-31S	Sleeve Fiber	p.19/p.36/p.48/ p.79/p.105
FT-31W	Threaded Type Fiber	p.12/p.36/p.48/ p.79/p.105
FT-40	Super Quality Fiber	p.11/p.36/p.48/ p.79
FT-42	Threaded Type Fiber	p.12/p.31/p.36/ p.48/p.79
FT-42S	Sleeve Fiber	p.19/p.36/p.48/ p.79/p.105
FT-42W	Threaded Type Fiber	p.12/p.36/p.48/ p.79/p.105
FT-43		
FT-45X		p.12/p.36/p.49/ p.79/p.105
FT-A11	Wide Beam Fiber	p.25/p.36/p.49/ p.79/p.105
FT-A11W		p.25/p.36/p.49/ p.79
FT-A32		
FT-A32W		p.25/p.36/p.49/ p.80
FT-AL05		
FT-E13	Cylindrical / Sleeve Fiber	p.16/p.19/p.36/ p.49/p.80
FT-E23		
FT-F93	Liquid Leak / Liquid Detection Fiber	p.35/p.36/p.49

FT-H13-FM2	Heat-resistant Fiber	p.30/p.36/p.50/ p.80
FT-H20-J20		p.31/p.44
FT-H20-J20-S		p.30/p.36/p.50/ p.80
FT-H20-J30		p.31/p.44
FT-H20-J30-S		p.30/p.36/p.50/ p.80
FT-H20-J50		p.31/p.44
FT-H20-J50-S		p.30/p.36/p.50/ p.80
FT-H20-M1		
FT-H20-VJ50		p.31/p.44
FT-H20-VJ50-S		p.30/p.36/p.50/ p.80
FT-H20-VJ80		p.31/p.44
FT-H20-VJ80-S		p.30/p.36/p.50/ p.80
FT-H20W-M1		
FT-H30-M1V		
FT-H30-M1V-S	Vacuum-resistant Fiber	p.32/p.36/p.50/ p.80
FT-H35-M2	Heat-resistant Fiber	p.30/p.36/p.50/ p.81
FT-H35-M2S6		
FT-HL80Y	Chemical / Oil-resistant Fiber	p.29/p.36/p.50/ p.81
FT-J8	Fiber for Atmospheric Side	p.33/p.44/p.66
FT-KS40	Narrow Beam Fiber	p.24/p.36/p.51/ p.81
FT-KV26		
FT-KV40		
FT-KV40W		
FT-L80Y	Chemical / Oil-resistant Fiber	p.29/p.36/p.51/ p.81
FT-R31	Square Head Type Fiber	p.15/p.36/p.51
FT-R40	Threaded Type Fiber	p.12/p.36/p.51/ p.81
FT-R41W	Square Head Type Fiber	p.14/p.15/p.36/ p.51/p.81
FT-R42W		
FT-R43		p.15/p.37/p.51
FT-R44Y	Square Head / Chemical / Oil-resistant Fiber	p.15/p.29/p.37/ p.52/p.82
FT-R60Y		
FT-S11	Cylindrical Fiber	p.16/p.37/p.52/ p.82
FT-S20	Super Quality Fiber	p.11/p.37/p.52/ p.82
FT-S21	Cylindrical Fiber	p.16/p.37/p.52/ p.82
FT-S21W		p.16/p.37/p.52/ p.82/p.105
FT-S30	Super Quality Fiber	p.11/p.37/p.52/ p.82
FT-S31W	Cylindrical Fiber	p.16/p.37/p.52/ p.82/p.105
FT-S32		p.16/p.37/p.52/ p.82
FT-V23	Sleeve Fiber	p.19/p.37/p.52/ p.82
FT-V24W		p.19/p.37/p.53/ p.82
FT-V25		
FT-V30		p.19/p.37/p.53/ p.83
FT-V40		
FT-V40	Cylindrical Fiber	p.16/p.37/p.53/ p.83
FT-V80Y	Chemical / Oil-resistant Fiber	p.29/p.37/p.53/ p.83

New product
introductionTough
FiberFiber
Selection
Guide

Model

Choose
by shape/
applicationHow to read
Model No.Earlier models
comparison
table

Fibers

Super
QualityThreaded
TypeSquare Head
TypeCylindrical
Type

Sleeve

Flat
TypeSmall
SpotNarrow
BeamWide
BeamConvergent
Reflective
TypeRetroreflective
TypeChemical / Oil-
resistantHeat-
resistantVacuum-
resistantLiquid Leak /
Liquid DetectionFiber
OptionsSemi-custom
fibersFiber
DimensionsThru-beam
TypeRetroreflective
TypeReflective
Type

Others

Amplifiers

FX-500
seriesFX-100
series

INDEX



FT-Z20HBW			
FT-Z20W		p.20/p.37/p.53/ p.83	
FT-Z30			
FT-Z30E	Flat Type Fiber		
FT-Z30EW			
FT-Z30H			
FT-Z30HW		p.20/p.37/p.54/ p.84	
FT-Z30W			
FT-Z40HBW			
FT-Z40W			
FT-Z802Y	Chemical / Oil-resistant Fiber	p.29/p.37/p.54/ p.84	
FTP-500			
FTP-1000			
FTP-1500	Protective Tube (For Thru-beam Type Fiber)		
FTP-N500		p.45/p.66	
FTP-N1000			
FTP-N1500			
FV-BR1	Photo-terminal for Vacuum-resistant Fiber	p.33/p.44/p.66	
FV-LE1	Vacuum-resistant Expansion Lens		
FV-SV2	Vacuum-resistant Side-view Lens	p.33/p.42/p.66	
FX-101			
FX-101-CC2			
FX-101P			
FX-101P-CC2	Digital Fiber Sensor FX-100 series		
FX-102		p.102/p.103/ p.104/p.110	
FX-102-CC2			
FX-102P			
FX-102P-CC2			
FX-501			
FX-501P	Digital Fiber Sensor FX-500 series	p.74/p.76/p.77/ p.96	
FX-502			
FX-502P			
FX-505-C2		p.74/p.76/p.78/ p.96	
FX-505P-C2			
FX-AT15A	Fiber Single-core Holder	p.45	
FX-AT2			
FX-AT3			
FX-AT4	Fiber Attachment		
FX-AT5		p.44/p.67	
FX-AT6			
FX-CT2			
FX-CT3		Fiber Cutter	p.44
FX-LE1		Lens for Thru-beam Type Fiber	p.42/p.67
FX-LE2			
FX-MB1	FX-500 Fiber Amplifier Protection Seal	p.75/p.76	
FX-MR1			
FX-MR2	Lens for Reflective Type Fiber	p.23/p.43/p.67	
FX-MR3			
FX-MR5			
FX-MR6			
FX-MR7			
FX-MR8		Square Head Type M3, Reflective Type Fiber & Spot Lens	p.23/p.43/p.68
FX-MR9			
FX-SV1	Side-view Lens for Thru-beam Type Fiber	p.42/p.69	

M

MS-AJ1-F	Universal Sensor Mounting Stand	p.45
MS-AJ2-F		
MS-DIN-2	FX-500 Amplifier Mounting Bracket	p.75/p.96
MS-DIN-4	FX-100 Amplifier Mounting Bracket	p.102/p.110

MS-DIN-E	End Plate	p.74/p.96/ p.102/p.110
MS-EX3	FX-MR2 Mounting Bracket	p.69
MS-FD-2	Fiber Mounting Bracket	p.33/p.44/p.69
MS-FD-3		p.69
MS-FD-F7-1	FD-F71 SUS Mounting Bracket	
MS-FD-F7-2	FD-F71 PVC Mounting Bracket	p.35
MS-FX-01Y	Liquid Inflow Prevention Joint	
MS-FX-02Y	Protective Tube Extension Joint	
MS-FX-03Y	Fiber Mounting Joint	p.35/p.45
MS-FX-YF	Joint Internal Ferrule	

R

RF-003	FR-KZ50E/KZ50H Exclusive Reflector	p.44/p.69
RF-13	Reflective Tape	
RF-210	Reflector	p.45/p.69
RF-220		
RF-230		

New product
introductionTough
FiberFiber
Selection
Guide

Model

Choose
by shape/
applicationHow to read
Model NoEarlier models
comparison
table

Fibers

Super
QualityThreaded
TypeSquare Head
TypeCylindrical
Type

Sleeve

Flat
TypeSmall
SpotNarrow
BeamWide
BeamConvergent
Reflective
TypeRetroreflective
TypeChemical / Oil-
resistantHeat-
resistantVacuum-
resistantLiquid Leak /
Liquid DetectionFiber
OptionsSemi-custom
fibersFiber
DimensionsThru-beam
TypeRetroreflective
TypeReflective
Type

Others

Amplifiers

FX-500
seriesFX-100
series

INDEX

MEMO

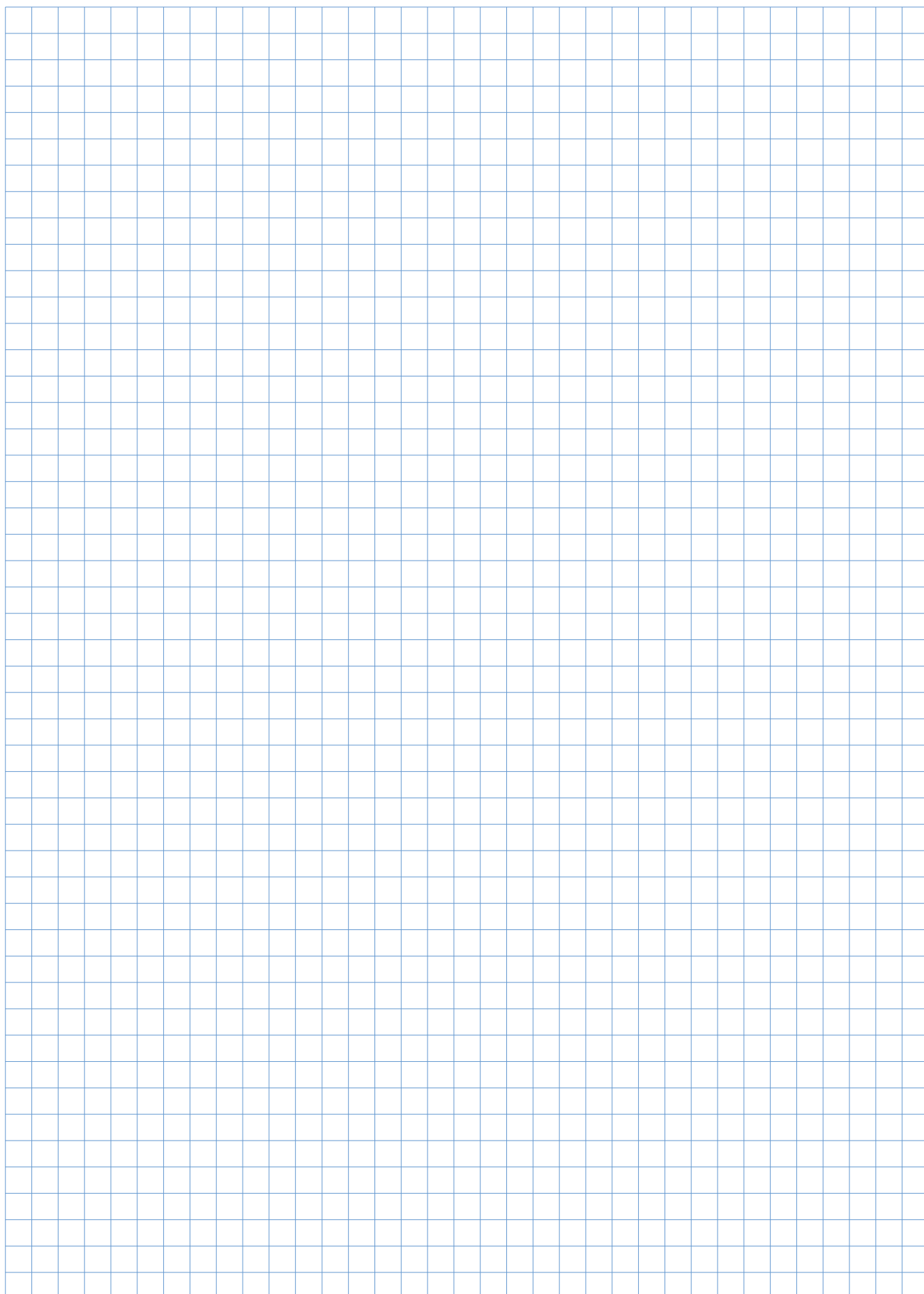

Communication Unit for Open Network

SC-GU3 SERIES

The digital sensor can be connected directly to the 3 types of open network!

Other types of analog input sensors can also be connected!

CC-Link
SC-GU3-01



DeviceNet
SC-GU3-02



EtherCAT
SC-GU3-03



Scattered digital sensors can be centrally managed and set through an open network.

Applicable Digital Sensor	Digital Fiber Sensor	Digital Laser Sensor	Digital Pressure Sensor
	FX-501 FX-502	LS-501 LS-403	DPS-401 DPS-402

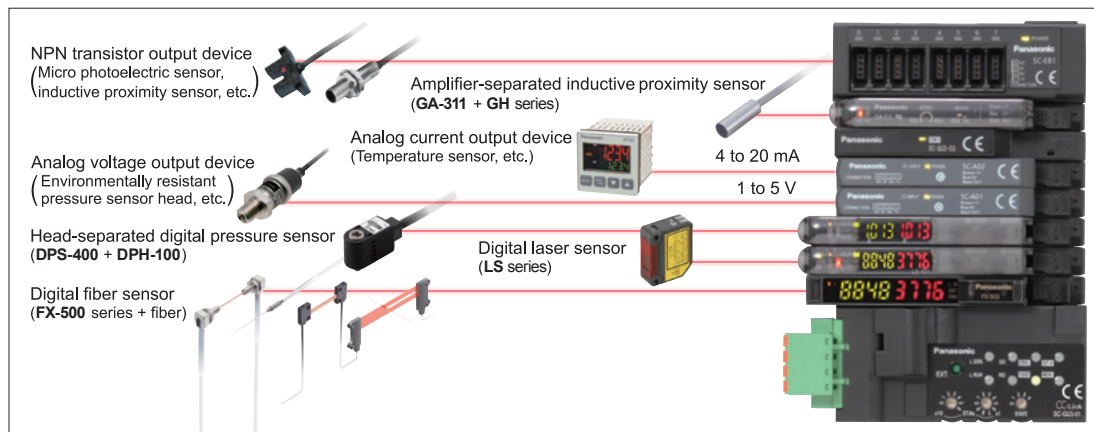

Please contact

Panasonic Industrial Devices SUNX Co., Ltd.

2431-1 Ushiyama-cho, Kasugai-shi, Aichi, 486-0901, Japan
 ■Telephone: +81-568-33-7211 ■Facsimile: +81-568-33-2631
 Global Sales Department
 ■Telephone: +81-568-33-7861 ■Facsimile: +81-568-33-8591
panasonic.net/id/pidsx/global



X-ON Electronics

Largest Supplier of Electrical and Electronic Components

Click to view similar products for [Fibre Optic Sensors](#) category:

Click to view products by [Panasonic](#) manufacturer:

Other Similar products are found below :

[FX-501](#) [E32T12B2M](#) [BFX-D1-N](#) [BFX-D1-P](#) [NT-D35FZ](#) [NFT-310](#) [NFTE-310](#) [CN-14A-R-C2](#) [CN-73-C1](#) [ASBSV 8/LED 5](#) [AU-F03-PNP-](#)
[NO](#) [LL3-TB01](#) [FD-31W](#) [FD-42G](#) [E32-D11L 2M](#) [E32-T11L 2M](#) [FS-04D-100](#) [FS-15T-100](#) [FX-101-CC2](#) [FX-101P](#) [FX-101P-CC2](#) [FX-101P-](#)
[Z](#) [FX-102-CC2](#) [FD-31](#) [FD-62](#) [FX-502](#) [E3X-NA41 2M](#) [FT-F93](#) [FX-102P-CC2](#) [FX-502P](#) [FX-505P-C2](#) [CN-73-C2](#) [CN-24A-C5](#) [CN-24A-C2](#)
[CN-14A-R-C5](#) [CN-14A-R-C1](#) [TEKT5400S](#) [FT-42](#) [FT-A11](#) [FX-301P](#) [HEDS-5540#A11](#) [SAIL-M8BW-4-10U](#) [YF2A15-100UB5XLEAX](#)
[E32-T14L 2M](#) [LL3-DT01](#) [FD-S21](#) [FT-R43](#) [FX301](#) [FX311](#) [FX311P](#)