

Panasonic

ideas for life

Relay for control panel of
1A to 10A (1c/2c/3c/4c)

HC RELAYS



Standard type



Amber sealed type



With diode type

RoHS compliant

FEATURES

1. Standard type and Amber sealed type
2. Rich lineup includes relays with operating indication, with diode
3. Full range of types
Plug-in type, PC board type and TM type
4. Sockets and terminal sockets are available.

TYPICAL APPLICATIONS

1. Factory automation equipment and automotive devices
2. Control panels, power supply equipment, molding equipment, machine tools, welding equipment, agricultural equipment, etc.
3. Office equipment, automatic vending machines, telecommunications equipment, disaster prevention equipment, copiers, measuring devices, medical equipment, amusement devices, etc.
4. All types of household appliance

ORDERING INFORMATION

Standard type

HC - - -

Contact arrangement

- 1: 1 Form C
- 2: 2 Form C
- 3: 3 Form C
- 4: 4 Form C
- 4D: Bifurcated contact (twin)

Terminal arrangement

- H: Plug-in type
- HL: Plug-in with LED indication
- HP: PC board type
- HPL: PC board with LED indication
- HTM: TM type

Nominal coil voltage

AC 6, 12, 24, 48, 100 (100/110), 120 (110/120),
200 (200/220), 240 (220/240) V
DC 6, 12, 24, 48, 100 (100/110) V

Contact material

| Contact arrangement | Contact material | AgSnO ₂ type | AgNi type |
|--------------------------|------------------|-------------------------|-----------|
| 1 Form C | | F | |
| 2 Form C | | F | |
| 3 Form C | | F | |
| 4 Form C | | | Nil |
| 4-pole bifurcated (twin) | | | Nil |

Amber sealed type

HC - - -

Contact arrangement

- 1: 1 Form C
- 2: 2 Form C
- 4: 4 Form C

Nil: Standard type

E: Amber sealed type

ED: Amber sealed type bifurcated contact (twin) (Only 4 Form C)

Terminal arrangement

- H: Plug-in type
- L: Plug-in with LED indication
- HP: PC board type
- PL: PC board with LED indication
- HTM: TM type

Nominal coil voltage

AC 6, 12, 24, 48, 100 (100/110), 120 (110/120),
200 (200/220), 240 (220/240) V
DC 6, 12, 24, 48, 100 (100/110) V

Contact material

| Contact arrangement | Contact material | AgSnO ₂ type | AgNi type |
|--------------------------|------------------|-------------------------|-----------|
| 1 Form C | | F | |
| 2 Form C | | F | |
| 4 Form C | | | Nil |
| 4-pole bifurcated (twin) | | | Nil |

With diode type (For DC)



Contact arrangement

- 1: 1 Form C
- 2: 2 Form C
- 3: 3 Form C
- 4: 4 Form C
- 4D: Bifurcated contact (twin)

Terminal arrangement

- Nil: Plug-in type
- L: Plug-in with LED indication

Nominal coil voltage

DC: 6, 12, 24, 48, 100 (100/110) V

Surge suppression

D: With diode

Contact material

| Contact arrangement | Contact material | AgSnO ₂ type | AgNi type |
|--------------------------|------------------|-------------------------|-----------|
| 1 Form C | | F | |
| 2 Form C | | F | |
| 3 Form C | | F | |
| 4 Form C | | | Nil |
| 4-pole bifurcated (twin) | | | Nil |

LINEUP

| Type | Contact arrangement | Plug-in terminal type | | PC board terminal type | | Top mounting type (TM type) | Remarks |
|---------------------------------------|---------------------|---------------------------|--------------------|----------------------------|----------|---------------------------------|----------------------------------|
| | | Without LED | With LED | Without LED | With LED | | |
| | | HC relay Standard type | Single side stable | 1 Form C | A | | |
| 2 Form C | A | | | A | A | A | |
| 3 Form C | A | | | A | A | A | |
| 4 Form C | A | | | A | A | A | |
| Bifurcated (Twin) | 4 Form C | | A | A | A | A | |
| HC relay Amber sealed type | Single side stable | 1 Form C | A | A | A | A | |
| | | 2 Form C | A | A | A | A | |
| | Bifurcated (Twin) | 4 Form C | A | A | A | A | |
| | | 4 Form C | A | A | A | A | |
| DC type with surge absorbing diode | Single side stable | 1 Form C | A | A | — | — | Amber sealed type also available |
| | | 2 Form C | A | A | — | — | |
| | | 3 Form C | A | A | — | — | |
| | | 4 Form C | A | A | — | — | |
| | Bifurcated (Twin) | 4 Form C | A | A | — | — | |

A: Available

Notes: 1. HC relays with ground terminals also available.

2. HC relays with 0.9 mm wide PC board terminals also available.

HC RELAY CONTACT ARRANGEMENT

| Type | Single side stable contact | 4-pole bifurcated (twin) contact |
|-------------|--|--|
| Part number | HC□ | HC4D |
| Features | Suitable for high-capacity load switching Standard type HC relays have high single-contact capacity; 1 Form C: 10 A 2 Form C and 3 Form C: 7 A 4 Form C: 5 A | Bifurcated (twin) contact ensures high contact reliability Suitable for low level loads Minimum switching capability: 100 μA 100m V DC (reference value) |

LED INDICATION TYPE

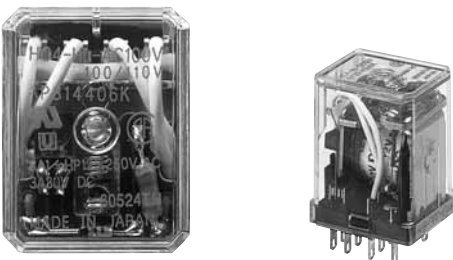
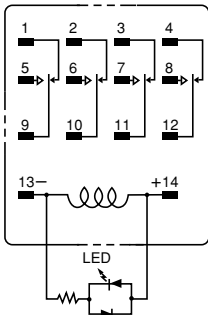
| | | | |
|-------------|---|--|---|
| Type | With LED indication type |  |  |
| Part number | HC□-HL | | |
| Features | <p>LED lights up when relay is operating</p> <p>Inspection and detection of trouble is easy.</p> <p>LEDs are green for DC types and red for AC types.</p> <p>All types are available with LED indication.</p> | <p>• LED colors indicate the type of relay: red for AC type and green for DC type.</p> | <p>Protection diode (Bottom view)</p> |

HC RELAY SERIES PRODUCT TYPES

| | | |
|-------------|--|--|
| Type | Amber sealed type HC relay | HC relay with diode type (for DC) |
| Part number | HC□E | HC□-□-□V-D |
| Features | <p>Relay is completely sealed with resin.</p> <p>Provides high reliability in adverse surroundings.</p> <p>Suitable for use in dusty conditions or where organic gases are present</p> | <p>Has built-in diode to absorb surge when the coil goes to the off state (for DC type).</p> <p>Suitable for protecting relay driver circuits and for noise suppression</p> <p>Diode characteristics: Reverse breakdown voltage 1,000 V</p> <p>Forward current 1 A</p> |

4-pole bifurcated (twin) type and Relay with LED indication are available.

TYPES

1. Standard type

1) Plug-in type

| Nominal coil voltage | 1 Form C | 2 Form C | 3 Form C | 4 Form C | 4 Form C (twin) |
|----------------------|----------------|----------------|----------------|--------------|-----------------|
| | Part No. | Part No. | Part No. | Part No. | Part No. |
| 6V AC | HC1-H-AC6V-F | HC2-H-AC6V-F | HC3-H-AC6V-F | HC4-H-AC6V | HC4D-H-AC6V |
| 12V AC | HC1-H-AC12V-F | HC2-H-AC12V-F | HC3-H-AC12V-F | HC4-H-AC12V | HC4D-H-AC12V |
| 24V AC | HC1-H-AC24V-F | HC2-H-AC24V-F | HC3-H-AC24V-F | HC4-H-AC24V | HC4D-H-AC24V |
| 48V AC | HC1-H-AC48V-F | HC2-H-AC48V-F | HC3-H-AC48V-F | HC4-H-AC48V | HC4D-H-AC48V |
| 100/110V AC | HC1-H-AC100V-F | HC2-H-AC100V-F | HC3-H-AC100V-F | HC4-H-AC100V | HC4D-H-AC100V |
| 110/120V AC | HC1-H-AC120V-F | HC2-H-AC120V-F | HC3-H-AC120V-F | HC4-H-AC120V | HC4D-H-AC120V |
| 200/220V AC | HC1-H-AC200V-F | HC2-H-AC200V-F | HC3-H-AC200V-F | HC4-H-AC200V | HC4D-H-AC200V |
| 220/240V AC | HC1-H-AC240V-F | HC2-H-AC240V-F | HC3-H-AC240V-F | HC4-H-AC240V | HC4D-H-AC240V |
| 6V DC | HC1-H-DC6V-F | HC2-H-DC6V-F | HC3-H-DC6V-F | HC4-H-DC6V | HC4D-H-DC6V |
| 12V DC | HC1-H-DC12V-F | HC2-H-DC12V-F | HC3-H-DC12V-F | HC4-H-DC12V | HC4D-H-DC12V |
| 24V DC | HC1-H-DC24V-F | HC2-H-DC24V-F | HC3-H-DC24V-F | HC4-H-DC24V | HC4D-H-DC24V |
| 48V DC | HC1-H-DC48V-F | HC2-H-DC48V-F | HC3-H-DC48V-F | HC4-H-DC48V | HC4D-H-DC48V |
| 100/110V DC | HC1-H-DC100V-F | HC2-H-DC100V-F | HC3-H-DC100V-F | HC4-H-DC100V | HC4D-H-DC100V |

Standard packing: Carton: 20 pcs.; Case: 200 pcs.

2) Plug-in type (with LED indication)

| Nominal coil voltage | 1 Form C | 2 Form C | 3 Form C | 4 Form C | 4 Form C (twin) |
|----------------------|-----------------|-----------------|-----------------|---------------|-----------------|
| | Part No. | Part No. | Part No. | Part No. | Part No. |
| 6V AC | HC1-HL-AC6V-F | HC2-HL-AC6V-F | HC3-HL-AC6V-F | HC4-HL-AC6V | HC4D-HL-AC6V |
| 12V AC | HC1-HL-AC12V-F | HC2-HL-AC12V-F | HC3-HL-AC12V-F | HC4-HL-AC12V | HC4D-HL-AC12V |
| 24V AC | HC1-HL-AC24V-F | HC2-HL-AC24V-F | HC3-HL-AC24V-F | HC4-HL-AC24V | HC4D-HL-AC24V |
| 100/110V AC | HC1-HL-AC100V-F | HC2-HL-AC100V-F | HC3-HL-AC100V-F | HC4-HL-AC100V | HC4D-HL-AC100V |
| 110/120V AC | HC1-HL-AC120V-F | HC2-HL-AC120V-F | HC3-HL-AC120V-F | HC4-HL-AC120V | HC4D-HL-AC120V |
| 200/220V AC | HC1-HL-AC200V-F | HC2-HL-AC200V-F | HC3-HL-AC200V-F | HC4-HL-AC200V | HC4D-HL-AC200V |
| 220/240V AC | HC1-HL-AC240V-F | HC2-HL-AC240V-F | HC3-HL-AC240V-F | HC4-HL-AC240V | HC4D-HL-AC240V |
| 6V DC | HC1-HL-DC6V-F | HC2-HL-DC6V-F | HC3-HL-DC6V-F | HC4-HL-DC6V | HC4D-HL-DC6V |
| 12V DC | HC1-HL-DC12V-F | HC2-HL-DC12V-F | HC3-HL-DC12V-F | HC4-HL-DC12V | HC4D-HL-DC12V |
| 24V DC | HC1-HL-DC24V-F | HC2-HL-DC24V-F | HC3-HL-DC24V-F | HC4-HL-DC24V | HC4D-HL-DC24V |
| 48V DC | HC1-HL-DC48V-F | HC2-HL-DC48V-F | HC3-HL-DC48V-F | HC4-HL-DC48V | HC4D-HL-DC48V |
| 100/110V DC | HC1-HL-DC100V-F | HC2-HL-DC100V-F | HC3-HL-DC100V-F | HC4-HL-DC100V | HC4D-HL-DC100V |

Standard packing: Carton: 20 pcs.; Case: 200 pcs.

3) PC board type

| Nominal coil voltage | 1 Form C | 2 Form C | 3 Form C | 4 Form C | 4 Form C (twin) |
|----------------------|-----------------|-----------------|-----------------|---------------|-----------------|
| | Part No. | Part No. | Part No. | Part No. | Part No. |
| 6V AC | HC1-HP-AC6V-F | HC2-HP-AC6V-F | HC3-HP-AC6V-F | HC4-HP-AC6V | HC4D-HP-AC6V |
| 12V AC | HC1-HP-AC12V-F | HC2-HP-AC12V-F | HC3-HP-AC12V-F | HC4-HP-AC12V | HC4D-HP-AC12V |
| 24V AC | HC1-HP-AC24V-F | HC2-HP-AC24V-F | HC3-HP-AC24V-F | HC4-HP-AC24V | HC4D-HP-AC24V |
| 48V AC | HC1-HP-AC48V-F | HC2-HP-AC48V-F | HC3-HP-AC48V-F | HC4-HP-AC48V | HC4D-HP-AC48V |
| 100/110V AC | HC1-HP-AC100V-F | HC2-HP-AC100V-F | HC3-HP-AC100V-F | HC4-HP-AC100V | HC4D-HP-AC100V |
| 110/120V AC | HC1-HP-AC120V-F | HC2-HP-AC120V-F | HC3-HP-AC120V-F | HC4-HP-AC120V | HC4D-HP-AC120V |
| 200/220V AC | HC1-HP-AC200V-F | HC2-HP-AC200V-F | HC3-HP-AC200V-F | HC4-HP-AC200V | HC4D-HP-AC200V |
| 220/240V AC | HC1-HP-AC240V-F | HC2-HP-AC240V-F | HC3-HP-AC240V-F | HC4-HP-AC240V | HC4D-HP-AC240V |
| 6V DC | HC1-HP-DC6V-F | HC2-HP-DC6V-F | HC3-HP-DC6V-F | HC4-HP-DC6V | HC4D-HP-DC6V |
| 12V DC | HC1-HP-DC12V-F | HC2-HP-DC12V-F | HC3-HP-DC12V-F | HC4-HP-DC12V | HC4D-HP-DC12V |
| 24V DC | HC1-HP-DC24V-F | HC2-HP-DC24V-F | HC3-HP-DC24V-F | HC4-HP-DC24V | HC4D-HP-DC24V |
| 48V DC | HC1-HP-DC48V-F | HC2-HP-DC48V-F | HC3-HP-DC48V-F | HC4-HP-DC48V | HC4D-HP-DC48V |
| 100/110V DC | HC1-HP-DC100V-F | HC2-HP-DC100V-F | HC3-HP-DC100V-F | HC4-HP-DC100V | HC4D-HP-DC100V |

Standard packing: Carton: 20 pcs.; Case: 200 pcs.

Note: Please add "-31" before "-F" in the part number when ordering the PC board type 0.9 mm width terminal (ex) HC1-HP-AC6V-31-F.

4) PC board type (with LED indication)

| Nominal coil voltage | 1 Form C | 2 Form C | 3 Form C | 4 Form C | 4 Form C (twin) |
|----------------------|------------------|------------------|------------------|----------------|-----------------|
| | Part No. | Part No. | Part No. | Part No. | Part No. |
| 6V AC | HC1-HPL-AC6V-F | HC2-HPL-AC6V-F | HC3-HPL-AC6V-F | HC4-HPL-AC6V | HC4D-HPL-AC6V |
| 12V AC | HC1-HPL-AC12V-F | HC2-HPL-AC12V-F | HC3-HPL-AC12V-F | HC4-HPL-AC12V | HC4D-HPL-AC12V |
| 24V AC | HC1-HPL-AC24V-F | HC2-HPL-AC24V-F | HC3-HPL-AC24V-F | HC4-HPL-AC24V | HC4D-HPL-AC24V |
| 100/110V AC | HC1-HPL-AC100V-F | HC2-HPL-AC100V-F | HC3-HPL-AC100V-F | HC4-HPL-AC100V | HC4D-HPL-AC100V |
| 110/120V AC | HC1-HPL-AC120V-F | HC2-HPL-AC120V-F | HC3-HPL-AC120V-F | HC4-HPL-AC120V | HC4D-HPL-AC120V |
| 200/220V AC | HC1-HPL-AC200V-F | HC2-HPL-AC200V-F | HC3-HPL-AC200V-F | HC4-HPL-AC200V | HC4D-HPL-AC200V |
| 6V DC | HC1-HPL-DC6V-F | HC2-HPL-DC6V-F | HC3-HPL-DC6V-F | HC4-HPL-DC6V | HC4D-HPL-DC6V |
| 12V DC | HC1-HPL-DC12V-F | HC2-HPL-DC12V-F | HC3-HPL-DC12V-F | HC4-HPL-DC12V | HC4D-HPL-DC12V |
| 24V DC | HC1-HPL-DC24V-F | HC2-HPL-DC24V-F | HC3-HPL-DC24V-F | HC4-HPL-DC24V | HC4D-HPL-DC24V |
| 48V DC | HC1-HPL-DC48V-F | HC2-HPL-DC48V-F | HC3-HPL-DC48V-F | HC4-HPL-DC48V | HC4D-HPL-DC48V |
| 100/110V DC | HC1-HPL-DC100V-F | HC2-HPL-DC100V-F | HC3-HPL-DC100V-F | HC4-HPL-DC100V | HC4D-HPL-DC100V |

Standard packing: Carton: 20 pcs.; Case: 200 pcs.

Note: Please add "-31" before "-F" in the part number when ordering the PC board type 0.9 mm width terminal (ex) HC1-HPL-AC6V-31-F.

5) TM type

| Nominal coil voltage | 1 Form C | 2 Form C | 3 Form C | 4 Form C | 4 Form C (twin) |
|----------------------|------------------|------------------|------------------|----------------|-----------------|
| | Part No. | Part No. | Part No. | Part No. | Part No. |
| 6V AC | HC1-HTM-AC6V-F | HC2-HTM-AC6V-F | HC3-HTM-AC6V-F | HC4-HTM-AC6V | HC4D-HTM-AC6V |
| 12V AC | HC1-HTM-AC12V-F | HC2-HTM-AC12V-F | HC3-HTM-AC12V-F | HC4-HTM-AC12V | HC4D-HTM-AC12V |
| 24V AC | HC1-HTM-AC24V-F | HC2-HTM-AC24V-F | HC3-HTM-AC24V-F | HC4-HTM-AC24V | HC4D-HTM-AC24V |
| 48V AC | HC1-HTM-AC48V-F | HC2-HTM-AC48V-F | HC3-HTM-AC48V-F | HC4-HTM-AC48V | HC4D-HTM-AC48V |
| 100/110V AC | HC1-HTM-AC100V-F | HC2-HTM-AC100V-F | HC3-HTM-AC100V-F | HC4-HTM-AC100V | HC4D-HTM-AC100V |
| 110/120V AC | HC1-HTM-AC120V-F | HC2-HTM-AC120V-F | HC3-HTM-AC120V-F | HC4-HTM-AC120V | HC4D-HTM-AC120V |
| 200/220V AC | HC1-HTM-AC200V-F | HC2-HTM-AC200V-F | HC3-HTM-AC200V-F | HC4-HTM-AC200V | HC4D-HTM-AC200V |
| 6V DC | HC1-HTM-DC6V-F | HC2-HTM-DC6V-F | HC3-HTM-DC6V-F | HC4-HTM-DC6V | HC4D-HTM-DC6V |
| 12V DC | HC1-HTM-DC12V-F | HC2-HTM-DC12V-F | HC3-HTM-DC12V-F | HC4-HTM-DC12V | HC4D-HTM-DC12V |
| 24V DC | HC1-HTM-DC24V-F | HC2-HTM-DC24V-F | HC3-HTM-DC24V-F | HC4-HTM-DC24V | HC4D-HTM-DC24V |
| 48V DC | HC1-HTM-DC48V-F | HC2-HTM-DC48V-F | HC3-HTM-DC48V-F | HC4-HTM-DC48V | HC4D-HTM-DC48V |
| 100/110V DC | HC1-HTM-DC100V-F | HC2-HTM-DC100V-F | HC3-HTM-DC100V-F | HC4-HTM-DC100V | HC4D-HTM-DC100V |

Standard packing: Carton: 20 pcs.; Case: 200 pcs.

HC

2. Amber sealed type

1) Plug-in type

| Nominal coil voltage | 1 Form C | 2 Form C | 4 Form C | 4 Form C (twin) |
|----------------------|-----------------|-----------------|---------------|-----------------|
| | Part No. | Part No. | Part No. | Part No. |
| 6V AC | HC1E-H-AC6V-F | HC2E-H-AC6V-F | HC4E-H-AC6V | HC4ED-H-AC6V |
| 12V AC | HC1E-H-AC12V-F | HC2E-H-AC12V-F | HC4E-H-AC12V | HC4ED-H-AC12V |
| 24V AC | HC1E-H-AC24V-F | HC2E-H-AC24V-F | HC4E-H-AC24V | HC4ED-H-AC24V |
| 48V AC | HC1E-H-AC48V-F | HC2E-H-AC48V-F | HC4E-H-AC48V | HC4ED-H-AC48V |
| 100/110V AC | HC1E-H-AC100V-F | HC2E-H-AC100V-F | HC4E-H-AC100V | HC4ED-H-AC100V |
| 110/120V AC | HC1E-H-AC120V-F | HC2E-H-AC120V-F | HC4E-H-AC120V | HC4ED-H-AC120V |
| 200/220V AC | HC1E-H-AC200V-F | HC2E-H-AC200V-F | HC4E-H-AC200V | HC4ED-H-AC200V |
| 220/240V AC | HC1E-H-AC240V-F | HC2E-H-AC240V-F | HC4E-H-AC240V | HC4ED-H-AC240V |
| 6V DC | HC1E-H-DC6V-F | HC2E-H-DC6V-F | HC4E-H-DC6V | HC4ED-H-DC6V |
| 12V DC | HC1E-H-DC12V-F | HC2E-H-DC12V-F | HC4E-H-DC12V | HC4ED-H-DC12V |
| 24V DC | HC1E-H-DC24V-F | HC2E-H-DC24V-F | HC4E-H-DC24V | HC4ED-H-DC24V |
| 48V DC | HC1E-H-DC48V-F | HC2E-H-DC48V-F | HC4E-H-DC48V | HC4ED-H-DC48V |
| 100/110V DC | HC1E-H-DC100V-F | HC2E-H-DC100V-F | HC4E-H-DC100V | HC4ED-H-DC100V |

Standard packing: Carton: 20 pcs.; Case: 200 pcs.

2) Plug-in type (With LED indication)

| Nominal coil voltage | 1 Form C | 2 Form C | 4 Form C | 4 Form C (twin) |
|----------------------|-----------------|-----------------|---------------|-----------------|
| | Part No. | Part No. | Part No. | Part No. |
| 6V AC | HC1E-L-AC6V-F | HC2E-L-AC6V-F | HC4E-L-AC6V | HC4ED-L-AC6V |
| 12V AC | HC1E-L-AC12V-F | HC2E-L-AC12V-F | HC4E-L-AC12V | HC4ED-L-AC12V |
| 24V AC | HC1E-L-AC24V-F | HC2E-L-AC24V-F | HC4E-L-AC24V | HC4ED-L-AC24V |
| 48V AC | HC1E-L-AC48V-F | HC2E-L-AC48V-F | HC4E-L-AC48V | HC4ED-L-AC48V |
| 100/110V AC | HC1E-L-AC100V-F | HC2E-L-AC100V-F | HC4E-L-AC100V | HC4ED-L-AC100V |
| 110/120V AC | HC1E-L-AC120V-F | HC2E-L-AC120V-F | HC4E-L-AC120V | HC4ED-L-AC120V |
| 200/220V AC | HC1E-L-AC200V-F | HC2E-L-AC200V-F | HC4E-L-AC200V | HC4ED-L-AC200V |
| 220/240V AC | HC1E-L-AC240V-F | HC2E-L-AC240V-F | HC4E-L-AC240V | HC4ED-L-AC240V |
| 6V DC | HC1E-L-DC6V-F | HC2E-L-DC6V-F | HC4E-L-DC6V | HC4ED-L-DC6V |
| 12V DC | HC1E-L-DC12V-F | HC2E-L-DC12V-F | HC4E-L-DC12V | HC4ED-L-DC12V |
| 24V DC | HC1E-L-DC24V-F | HC2E-L-DC24V-F | HC4E-L-DC24V | HC4ED-L-DC24V |
| 48V DC | HC1E-L-DC48V-F | HC2E-L-DC48V-F | HC4E-L-DC48V | HC4ED-L-DC48V |
| 100/110V DC | HC1E-L-DC100V-F | HC2E-L-DC100V-F | HC4E-L-DC100V | HC4ED-L-DC100V |

Standard packing: Carton: 20 pcs.; Case: 200 pcs.

3) PC board type

| Nominal coil voltage | 1 Form C | 2 Form C | 4 Form C | 4 Form C (twin) |
|----------------------|------------------|------------------|----------------|-----------------|
| | Part No. | Part No. | Part No. | Part No. |
| 6V AC | HC1E-HP-AC6V-F | HC2E-HP-AC6V-F | HC4E-HP-AC6V | HC4ED-HP-AC6V |
| 12V AC | HC1E-HP-AC12V-F | HC2E-HP-AC12V-F | HC4E-HP-AC12V | HC4ED-HP-AC12V |
| 24V AC | HC1E-HP-AC24V-F | HC2E-HP-AC24V-F | HC4E-HP-AC24V | HC4ED-HP-AC24V |
| 48V AC | HC1E-HP-AC48V-F | HC2E-HP-AC48V-F | HC4E-HP-AC48V | HC4ED-HP-AC48V |
| 100/110V AC | HC1E-HP-AC100V-F | HC2E-HP-AC100V-F | HC4E-HP-AC100V | HC4ED-HP-AC100V |
| 110/120V AC | HC1E-HP-AC120V-F | HC2E-HP-AC120V-F | HC4E-HP-AC120V | HC4ED-HP-AC120V |
| 200/220V AC | HC1E-HP-AC200V-F | HC2E-HP-AC200V-F | HC4E-HP-AC200V | HC4ED-HP-AC200V |
| 220/240V AC | HC1E-HP-AC240V-F | HC2E-HP-AC240V-F | HC4E-HP-AC240V | HC4ED-HP-AC240V |
| 6V DC | HC1E-HP-DC6V-F | HC2E-HP-DC6V-F | HC4E-HP-DC6V | HC4ED-HP-DC6V |
| 12V DC | HC1E-HP-DC12V-F | HC2E-HP-DC12V-F | HC4E-HP-DC12V | HC4ED-HP-DC12V |
| 24V DC | HC1E-HP-DC24V-F | HC2E-HP-DC24V-F | HC4E-HP-DC24V | HC4ED-HP-DC24V |
| 48V DC | HC1E-HP-DC48V-F | HC2E-HP-DC48V-F | HC4E-HP-DC48V | HC4ED-HP-DC48V |
| 100/110V DC | HC1E-HP-DC100V-F | HC2E-HP-DC100V-F | HC4E-HP-DC100V | HC4ED-HP-DC100V |

Standard packing: Carton: 20 pcs.; Case: 200 pcs.

Note: Please add "-31" in the suffix of part number when ordering the PC board type 0.9 mm width terminal. (4 Form C, 4 Form C (twin) only)

4) PC board type (With LED indication)

| Nominal coil voltage | 1 Form C | 2 Form C | 4 Form C | 4 Form C (twin) |
|----------------------|------------------|------------------|----------------|-----------------|
| | Part No. | Part No. | Part No. | Part No. |
| 6V AC | HC1E-PL-AC6V-F | HC2E-PL-AC6V-F | HC4E-PL-AC6V | HC4ED-PL-AC6V |
| 12V AC | HC1E-PL-AC12V-F | HC2E-PL-AC12V-F | HC4E-PL-AC12V | HC4ED-PL-AC12V |
| 24V AC | HC1E-PL-AC24V-F | HC2E-PL-AC24V-F | HC4E-PL-AC24V | HC4ED-PL-AC24V |
| 48V AC | HC1E-PL-AC48V-F | HC2E-PL-AC48V-F | HC4E-PL-AC48V | HC4ED-PL-AC48V |
| 100/110V AC | HC1E-PL-AC100V-F | HC2E-PL-AC100V-F | HC4E-PL-AC100V | HC4ED-PL-AC100V |
| 110/120V AC | HC1E-PL-AC120V-F | HC2E-PL-AC120V-F | HC4E-PL-AC120V | HC4ED-PL-AC120V |
| 200/220V AC | HC1E-PL-AC200V-F | HC2E-PL-AC200V-F | HC4E-PL-AC200V | HC4ED-PL-AC200V |
| 220/240V AC | HC1E-PL-AC240V-F | HC2E-PL-AC240V-F | HC4E-PL-AC240V | HC4ED-PL-AC240V |
| 6V DC | HC1E-PL-DC6V-F | HC2E-PL-DC6V-F | HC4E-PL-DC6V | HC4ED-PL-DC6V |
| 12V DC | HC1E-PL-DC12V-F | HC2E-PL-DC12V-F | HC4E-PL-DC12V | HC4ED-PL-DC12V |
| 24V DC | HC1E-PL-DC24V-F | HC2E-PL-DC24V-F | HC4E-PL-DC24V | HC4ED-PL-DC24V |
| 48V DC | HC1E-PL-DC48V-F | HC2E-PL-DC48V-F | HC4E-PL-DC48V | HC4ED-PL-DC48V |
| 100/110V DC | HC1E-PL-DC100V-F | HC2E-PL-DC100V-F | HC4E-PL-DC100V | HC4ED-PL-DC100V |

Standard packing: Carton: 20 pcs.; Case: 200 pcs.

Note: Please add "-31" in the suffix of part number when ordering the PC board type 0.9 mm width terminal. (4 Form C, 4 Form C (twin) only)

5) TM type

| Nominal coil voltage | 1 Form C | 2 Form C | 4 Form C | 4 Form C (twin) |
|----------------------|-------------------|-------------------|-----------------|------------------|
| | Part No. | Part No. | Part No. | Part No. |
| 6V AC | HC1E-HTM-AC6V-F | HC2E-HTM-AC6V-F | HC4E-HTM-AC6V | HC4ED-HTM-AC6V |
| 12V AC | HC1E-HTM-AC12V-F | HC2E-HTM-AC12V-F | HC4E-HTM-AC12V | HC4ED-HTM-AC12V |
| 24V AC | HC1E-HTM-AC24V-F | HC2E-HTM-AC24V-F | HC4E-HTM-AC24V | HC4ED-HTM-AC24V |
| 48V AC | HC1E-HTM-AC48V-F | HC2E-HTM-AC48V-F | HC4E-HTM-AC48V | HC4ED-HTM-AC48V |
| 100/110V AC | HC1E-HTM-AC100V-F | HC2E-HTM-AC100V-F | HC4E-HTM-AC100V | HC4ED-HTM-AC100V |
| 110/120V AC | HC1E-HTM-AC120V-F | HC2E-HTM-AC120V-F | HC4E-HTM-AC120V | HC4ED-HTM-AC120V |
| 200/220V AC | HC1E-HTM-AC200V-F | HC2E-HTM-AC200V-F | HC4E-HTM-AC200V | HC4ED-HTM-AC200V |
| 220/240V AC | HC1E-HTM-AC240V-F | HC2E-HTM-AC240V-F | HC4E-HTM-AC240V | HC4ED-HTM-AC240V |
| 6V DC | HC1E-HTM-DC6V-F | HC2E-HTM-DC6V-F | HC4E-HTM-DC6V | HC4ED-HTM-DC6V |
| 12V DC | HC1E-HTM-DC12V-F | HC2E-HTM-DC12V-F | HC4E-HTM-DC12V | HC4ED-HTM-DC12V |
| 24V DC | HC1E-HTM-DC24V-F | HC2E-HTM-DC24V-F | HC4E-HTM-DC24V | HC4ED-HTM-DC24V |
| 48V DC | HC1E-HTM-DC48V-F | HC2E-HTM-DC48V-F | HC4E-HTM-DC48V | HC4ED-HTM-DC48V |
| 100/110V DC | HC1E-HTM-DC100V-F | HC2E-HTM-DC100V-F | HC4E-HTM-DC100V | HC4ED-HTM-DC100V |

Standard packing: Carton: 20 pcs.; Case: 200 pcs.

4. With diode type (For DC)

1) Plug-in type

| Nominal coil voltage | 1 Form C | 2 Form C | 3 Form C | 4 Form C | 4 Form C (twin) |
|----------------------|----------------|----------------|----------------|--------------|-----------------|
| | Part No. | Part No. | Part No. | Part No. | Part No. |
| 6V DC | HC1-DC6V-D-F | HC2-DC6V-D-F | HC3-DC6V-D-F | HC4-DC6V-D | HC4D-DC6V-D |
| 12V DC | HC1-DC12V-D-F | HC2-DC12V-D-F | HC3-DC12V-D-F | HC4-DC12V-D | HC4D-DC12V-D |
| 24V DC | HC1-DC24V-D-F | HC2-DC24V-D-F | HC3-DC24V-D-F | HC4-DC24V-D | HC4D-DC24V-D |
| 48V DC | HC1-DC48V-D-F | HC2-DC48V-D-F | HC3-DC48V-D-F | HC4-DC48V-D | HC4D-DC48V-D |
| 100/110V DC | HC1-DC100V-D-F | HC2-DC100V-D-F | HC3-DC100V-D-F | HC4-DC100V-D | HC4D-DC100V-D |

Standard packing: Carton: 20 pcs.; Case: 200 pcs.

2) Plug-in type (with LED indication)

| Nominal coil voltage | 1 Form C | 2 Form C | 3 Form C | 4 Form C | 4 Form C (twin) |
|----------------------|------------------|------------------|------------------|----------------|-----------------|
| | Part No. | Part No. | Part No. | Part No. | Part No. |
| 6V DC | HC1-L-DC6V-D-F | HC2-L-DC6V-D-F | HC3-L-DC6V-D-F | HC4-L-DC6V-D | HC4D-L-DC6V-D |
| 12V DC | HC1-L-DC12V-D-F | HC2-L-DC12V-D-F | HC3-L-DC12V-D-F | HC4-L-DC12V-D | HC4D-L-DC12V-D |
| 24V DC | HC1-L-DC24V-D-F | HC2-L-DC24V-D-F | HC3-L-DC24V-D-F | HC4-L-DC24V-D | HC4D-L-DC24V-D |
| 48V DC | HC1-L-DC48V-D-F | HC2-L-DC48V-D-F | HC3-L-DC48V-D-F | HC4-L-DC48V-D | HC4D-L-DC48V-D |
| 100/110V DC | HC1-L-DC100V-D-F | HC2-L-DC100V-D-F | HC3-L-DC100V-D-F | HC4-L-DC100V-D | HC4D-L-DC100V-D |

Standard packing: Carton: 20 pcs.; Case: 200 pcs.

RATING

1. Standard type

1) Coil data

(1) AC coils (50/60Hz)

| Type | Nominal coil voltage | Pick-up voltage (at 20°C 68°F) | Drop-out voltage (at 20°C 68°F) | Nominal coil current [±20%] (at 20°C 68°F) | | Coil inductance | | Nominal operating power | | Max. applied voltage (at 70°C 158°F) |
|-------------|----------------------|---|---|--|-------------|-----------------|----------------|-------------------------|-------|--------------------------------------|
| | | | | 50Hz | 60Hz | N.C. condition | N.O. condition | 50Hz | 60Hz | |
| Standard | 6V AC | 80%V or less of nominal voltage (Initial) | 30%V or more of nominal voltage (Initial) | 224mA | 200mA | 0.078H | 0.074H | 1.3VA | 1.2VA | 110%V of nominal voltage |
| | 12V AC | | | 111mA | 100mA | 0.312H | 0.295H | | | |
| | 24V AC | | | 56mA | 50mA | 1.243H | 1.181H | | | |
| | 48V AC | | | 28mA | 25mA | 4.974H | 4.145H | | | |
| | 100/110V AC | | | 13.4/14.7mA | 12/13.2mA | 23.75H | 20.63H | | | |
| | 110/120V AC | | | 12.2/13.5mA | 10.9/11.9mA | 27.19H | 25.57H | | | |
| 200/220V AC | 6.7/7.4mA | 6/6.6mA | 85.98H | 81.76H | | | | | | |

Notes: 1. The relay operates in a range of 80% to 110% V of the voltage rating, but ideally, in consideration of temporary voltage fluctuations, it should be operated at the rated voltage. In particular, for AC operation, if the applied voltage drops to 80% V or more below the rated voltage, humming will occur and a large current will flow leading possibly to coil burnout.

2. The maximum applied voltage is the maximum voltage fluctuation value for the coil power supply. This value is not a permissible value for continuous operation. (This value differs depending on the ambient temperature. Please contact us for details.)

(2) DC coils

| Type | Nominal coil voltage | Pick-up voltage (at 20°C 68°F) | Drop-out voltage (at 20°C 68°F) | Nominal coil current [±10%] (at 20°C 68°F) | Coil resistance [±10%] (at 20°C 68°F) | Nominal operating power | Max. applied voltage (at 70°C 158°F) |
|----------|----------------------|---|---|--|---------------------------------------|-------------------------|--------------------------------------|
| Standard | 6V DC | 80%V or less of nominal voltage (Initial) | 10%V or more of nominal voltage (Initial) | 150mA | 40Ω | 0.9W | 110%V of nominal voltage |
| | 12V DC | | | 75mA | 160Ω | | |
| | 24V DC | | | 37mA | 650Ω | | |
| | 48V DC | | | 18.5mA | 2,600Ω | | |
| | 100/110V DC | | | 10/11mA | 10,000Ω | 1.0W | |

Notes: 1. The coil resistance for DC operation is the value measured when the coil temperature is 20°C 68°F. Compensate ±0.4% for every ±1°C change in temperature.

2. The relay operates in a range of 80% to 110% V of the voltage rating, but ideally, in consideration of temporary voltage fluctuations, it should be operated at the rated voltage.

3. For use with 200 V DC, connect a 10 KΩ (5W) resistor, in series, to the 100 V DC relay.

4. The maximum applied voltage is the maximum voltage fluctuation value for the coil power supply. This value is not a permissible value for continuous operation. (This value differs depending on the ambient temperature. Please contact us for details.)

2) Specifications

| Characteristics | Item | Specifications | | | | |
|----------------------------|---|--|---|--|--|--|
| | | 1 Form C | 2 Form C | 3 Form C | 4 Form C | 4 Form C (twin) |
| Contact | Arrangement | Max. 30 mΩ (By voltage drop 6 V DC 1A) | | | | |
| | Contact resistance (Initial) | Max. 30 mΩ (By voltage drop 6 V DC 1A) | | | | |
| | Contact material | Ag alloy (cd free) + Au flash | | | AgNi type + Au clad | |
| Rating | Nominal switching capacity (resistive load) | 10A 250V AC | 7A 250V AC | 7A 250V AC | 5A 250V AC | 3A 250V AC |
| | Max. switching power (resistive load) | 2,500VA | 1,750VA | 1,750VA | 1,250VA | 750VA |
| | Max. switching voltage | 250VAC | | | | |
| | Max. switching current*4 | 10A | 7A | 7A | 5A | 3A |
| | Nominal operating power | AC (50Hz): 1.3VA, AC (60Hz): 1.2VA, DC: 0.9 to 1.1W | | | | |
| | Min. switching capacity (Reference value)*1 | 1mA 1V DC | | | | 100μA 1V DC |
| Electrical characteristics | Insulation resistance (Initial) | Min. 1,000MΩ (at 500V DC) Measurement at same location as "Breakdown voltage" section. | | | | |
| | Breakdown voltage (Initial) | Between open contacts | 700 Vrms for 1min. (Detection current: 10mA.) | | | |
| | | Between contact sets | 700 Vrms for 1min. (Detection current: 10mA.) | | | |
| | | Between contact and coil | 2,000 Vrms for 1min. (Detection current: 10mA.) | | | |
| | Temperature rise (coil) (at 70°C 158°F) | Max. 80°C 176°F (By resistive method, nominal coil voltage) | | | | |
| | Operate time (at 20°C 68°F)*2 | Max. 20ms (Nominal coil voltage applied to the coil, excluding contact bounce time.) | | | | |
| | Release time (at 20°C 68°F)*2 | Max. 20ms (Nominal coil voltage applied to the coil, excluding contact bounce time.) (without diode) | | | | |
| | Mechanical characteristics | Shock resistance | Functional | Min. 196 m/s ² (Half-wave pulse of sine wave: 11 ms; detection time: 10μs.) | | |
| Destructive | | | Min. 980 m/s ² (Half-wave pulse of sine wave: 6 ms.) | | | |
| Vibration resistance | | Functional | 10 to 55 Hz at double amplitude of 1 mm (Detection time: 10μs.) | | | |
| | | Destructive | 10 to 55 Hz at double amplitude of 2 mm | | | |
| Expected life | Mechanical | Min. 5×10 ⁷ : AC coil type (at 180 times/min.); Min. 10 ⁸ : DC coil type (at 180 times/min.) | | | | |
| | Electrical | Min. 2×10 ⁵ resistive load (at 20 times/min.) | Min. 2×10 ⁵ resistive load (at 20 times/min.) | Min. 10 ⁵ resistive load (at 20 times/min.) | Min. 2×10 ⁵ resistive load (at 20 times/min.) | Min. 2×10 ⁵ resistive load (at 20 times/min.) |
| Conditions | Conditions for operation, transport and storage*3 | Ambient temperature: -50°C to +70°C -58°F to +158°F (without LED); -50°C to +60°C -58°F to +140°F (with LED) Humidity: 5 to 85% R.H. (Not freezing and condensing at low temperature) | | | | |
| | Max. Operating speed | 20 times/min. (at max. rating) | | | | |
| Unit weight | | Approx. 30g 1.06 oz | | | | |

Notes: *1. This value can change due to the switching frequency, environmental conditions and desired reliability level, therefore it is recommended to check this with the actual load.
 *2. For the AC coil types, the operate/release time will differ depending on the phase.
 *3. The upper limit of the ambient temperature is the maximum temperature that can satisfy the coil temperature rise value. Refer to Usage, transport and storage conditions in NOTES.
 *4. When using the socket and terminal socket, be sure to verify the max. continuous current.

3) Switching capacity and expected life

(1) Electrical (at 20 times/min.)

| Load | AC | | | | DC | | Expected life |
|-----------------|-----------------------|---------|-------------------------|---------|-----------|-----------|------------------------|
| | Resistive (cos φ = 1) | | Inductive (cos φ ≈ 0.4) | | Resistive | Inductive | |
| | 125V AC | 250V AC | 125V AC | 250V AC | 30V DC | 30V DC | |
| 1 Form C | 10A | 10A | 5A | 3A | — | — | Min. 2×10 ⁵ |
| | 7A | 7A | 3A | 2.5A | 3A | 1A | Min. 5×10 ⁵ |
| | 5A | 5A | 2A | 1.5A | — | — | Min. 10 ⁶ |
| 2 Form C | 7A | 7A | 3.5A | 2A | — | — | Min. 2×10 ⁵ |
| | 5A | 5A | 2.5A | 1.5A | 3A | 0.6A | Min. 5×10 ⁵ |
| | 3A | 3A | 1.5A | 1A | — | — | Min. 10 ⁶ |
| 3 Form C | 7A | 7A | — | — | — | — | Min. 10 ⁵ |
| | — | — | 3.5A | 2A | — | — | Min. 2×10 ⁵ |
| | 5A | 5A | — | — | 3A | 0.4A | Min. 5×10 ⁵ |
| 4 Form C | 5A | 5A | 2A | 1A | — | — | Min. 2×10 ⁵ |
| | 3A | 3A | 1A | 0.8A | 3A | 0.4A | Min. 5×10 ⁵ |
| | 2A | 2A | 0.5A | 0.4A | — | — | Min. 10 ⁶ |
| 4 Form C (twin) | 3A | 3A | 1A | 0.8A | 3A | — | Min. 2×10 ⁵ |

(2) Mechanical (at 180 times/min.)

AC coil type: Min. 5×10⁷; DC coil type: Min. 10⁸

HC

2. Amber sealed type

1) Coil data

Same coil data as HC relay standard type. Please refer to standard type information.

2) Specifications

| Characteristics | Item | Specifications | | | |
|----------------------------|---|--|------------|------------|-----------------|
| | | 1 Form C | 2 Form C | 4 Form C | 4 Form C (twin) |
| Contact | Arrangement | 1 Form C | 2 Form C | 4 Form C | 4 Form C |
| Rating | Nominal switching capacity (resistive load) | 5A 250V AC | 3A 250V AC | 2A 250V AC | 1A 250V AC |
| | Max. switching power (resistive load) | 1,250VA | 700VA | 500VA | 250VA |
| | Max. switching voltage | 250VAC | 250VAC | 250VAC | 250VAC |
| | Max. switching current | 5A | 3A | 2A | 1A |
| | Min. switching capacity (Reference value)*1 | 1mA 100mV DC | | | 100μA 100mV DC |
| Electrical characteristics | Temperature rise (coil) (at 60°C 140°F) | Max. 90°C 194°F (By resistive method, nominal voltage) | | | |
| Expected life | Electrical | Min. 2×10 ⁵ resistive load (at 20 times/min.) | | | |
| Conditions | Conditions for operation, transport and storage*2 | Ambient temperature: -40°C to +60°C -40°F to +140°F; Humidity: 5 to 85% R.H. (Not freezing and condensing at low temperature) | | | |
| | Ambient air pressure | 760mmHg±20% (1,013mb±20%) | | | |

Notes: Other specifications are same as standard types.

*1. This value can change due to the switching frequency, environmental conditions and desired reliability level, therefore it is recommended to check this with the actual load.

*2. The upper limit of the ambient temperature is the maximum temperature that can satisfy the coil temperature rise value. Refer to Usage, transport and storage conditions in NOTES.

3) Switching capacity and expected life

(1) Electrical (at 20 times/min.)

| Load | AC | | | | DC | | Expected life |
|-----------------------|-----------------------|---------|-------------------------|---------|-----------|-----------|------------------------|
| | Resistive (cos φ = 1) | | Inductive (cos φ ≅ 0.4) | | Resistive | Inductive | |
| Voltage | 125V AC | 250V AC | 125V AC | 250V AC | 30V DC | 30V DC | |
| HC1E | 5A | 5A | — | — | 3A | 1A | Min. 2×10 ⁵ |
| HC2E | 3A | 3A | — | — | 2A | 0.7A | Min. 2×10 ⁵ |
| HC4E | 2A | 2A | — | — | 2A | 0.6A | Min. 2×10 ⁵ |
| HC4ED (4 Form C twin) | 1A | 1A | — | — | — | — | Min. 2×10 ⁵ |

(2) Mechanical (at 180 times/min.)

AC coil type: Min. 5×10⁷; DC coil type: Min. 10⁸

3. With diode type (For DC)

1) Coil data

Same coil data as HC relay standard type for DC. Please refer to standard type information.

Please connect DC coil type built-in diode correctly by verifying the coil polarity.

2) Specifications

| Characteristics | Item | Specifications |
|-----------------|--|---|
| Conditions | Conditions for operation, transport and storage* | Ambient temperature: -50°C to +60°C -58°F to +140°F Humidity: 5 to 85% R.H. (Not freezing and condensing at low temperature) |

Notes: Other specifications are same as standard type HC relay. Please see the standard type HC relay.

* The upper limit of the ambient temperature is the maximum temperature that can satisfy the coil temperature rise value. Refer to Usage, transport and storage conditions in NOTES.

REFERENCE DATA

Standard type

1. Life curve

Load: 250 V AC resistive load

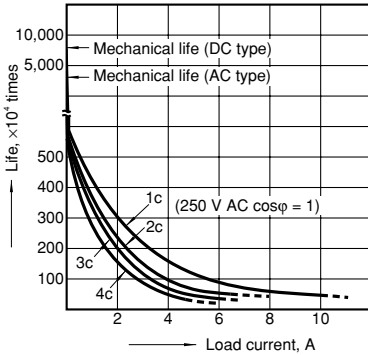

2.-(1) Switching capacity range (single contact type)

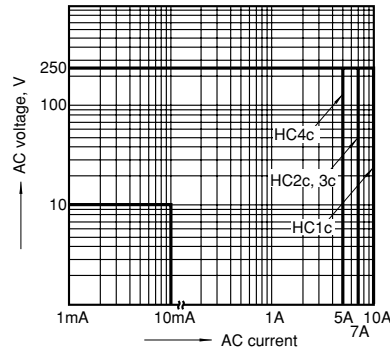

2.-(2) Switching capacity range (4-pole bifurcated (twin) contact type)

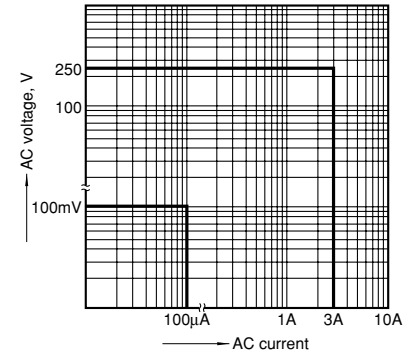

3.-(1) Coil temperature rise (1 Form C, AC type)

Measured portion: Inside the coil
Ambient temperature: 25°C 77°F (See note.)

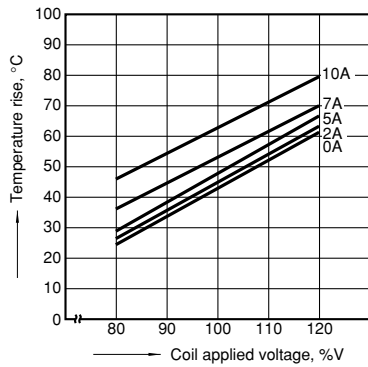

3.-(2) Coil temperature rise (2 Form C, AC type)

Measured portion: Inside the coil
Ambient temperature: 30°C 86°F (See note.)

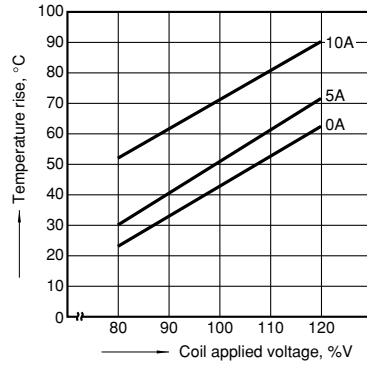

3.-(3) Coil temperature rise (3 Form C, AC type)

Measured portion: Inside the coil
Ambient temperature: 18°C 64°F (See note.)

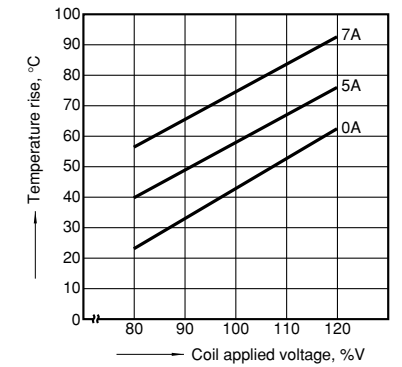

3.-(4) Coil temperature rise (4 Form C, AC type)

Measured portion: Inside the coil
Ambient temperature: 15 to 21°C 59 to 70°F (See note.)

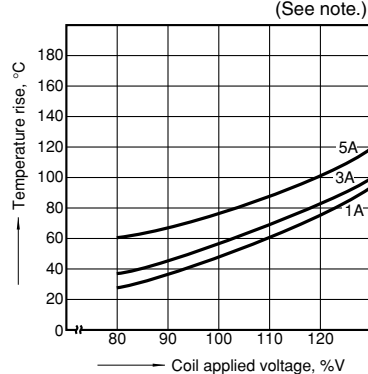

3.-(5) Coil temperature rise (1 Form C, DC type)

Measured portion: Inside the coil
Ambient temperature: 29°C 84°F

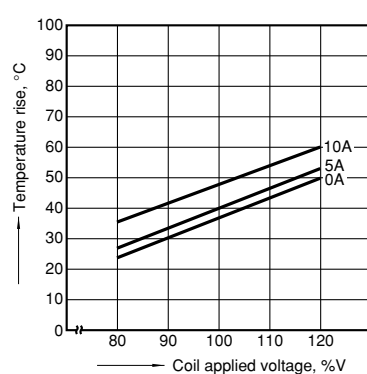

3.-(6) Coil temperature rise (2 Form C, DC type)

Measured portion: Inside the coil
Ambient temperature: 29°C 84°F

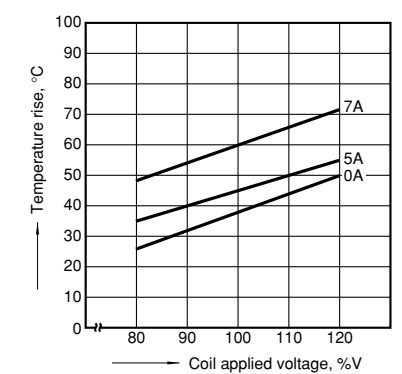

3.-(7) Coil temperature rise (3 Form C, DC type)

Measured portion: Inside the coil
Ambient temperature: 29°C 84°F

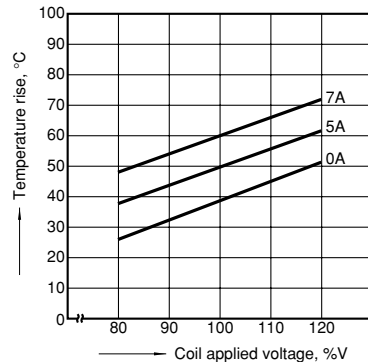

3.-(8) Coil temperature rise (4 Form C, DC type)

Measured portion: Inside the coil
Ambient temperature: 17 to 18°C 62 to 64°F

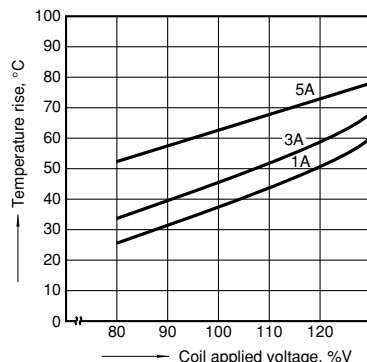

Note: Coil temperature rise

When the nominal voltage is applied to AC 120 or 240 V coil types respectively, the figures of coil temperature rise increase by approx. 10 degrees to the ones shown on each graph.

Amber sealed type

1.-(1) Switching capacity range
(single contact type)

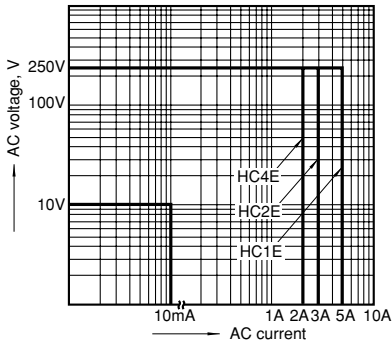

1.-(2) Switching capacity range
(4-pole bifurcated (twin) contact type)

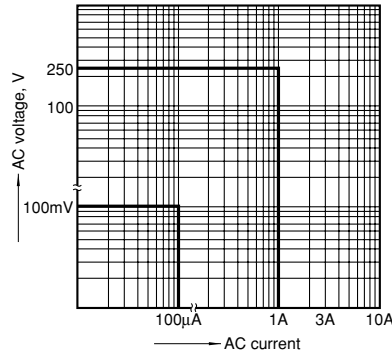

2.-(1) Coil temperature rise (1 Form C AC type)
Measured portion: Inside the coil
Ambient temperature: 30°C 86°F

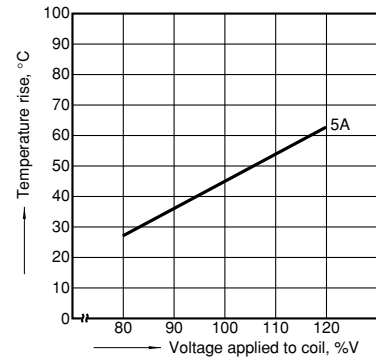

2.-(2) Coil temperature rise (2 Form C AC type)
Measured portion: Inside the coil
Ambient temperature: 30°C 86°F (See note.)

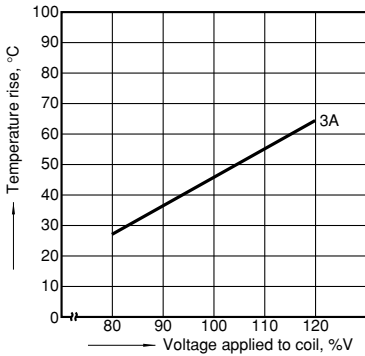

2.-(3) Coil temperature rise (4 Form C AC type)
Measured portion: Inside the coil
Ambient temperature: 30°C 86°F (See note.)

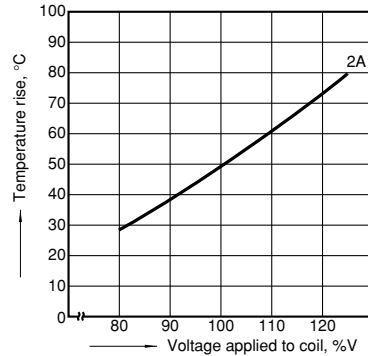

2.-(4) Coil temperature rise (1 Form C DC type)
Measured portion: Inside the coil
Ambient temperature: 30°C 86°F

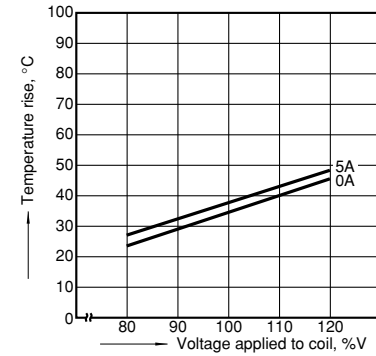

2.-(5) Coil temperature rise (2 Form C DC type)
Measured portion: Inside the coil
Ambient temperature: 30°C 86°F

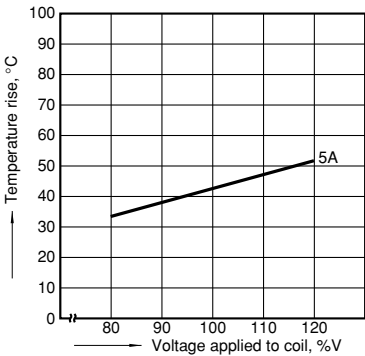

Note: Coil temperature rise

When the nominal voltage is applied to AC 120 or 240 V coil types respectively, the figures of coil temperature rise increase by approx. 10 degrees to the ones shown on each graph.

With diode type (For DC)

1.-(1) DC coil surge voltage waveform
(without diode)

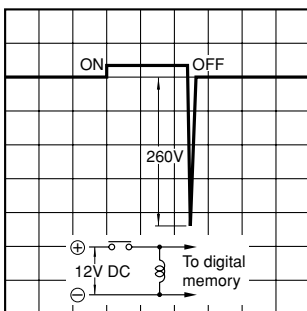

1.-(2) DC coil surge voltage waveform
(with diode)

Diode characteristics;
Reverse breakdown voltage: 1,000V,
Forward current: 1A

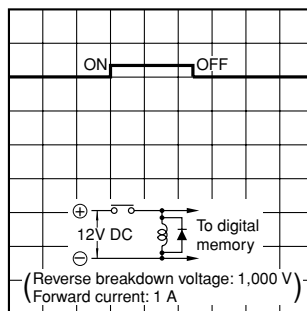

DIMENSIONS (mm inch)

The CAD data of the products with a **CAD Data** mark can be downloaded from: <http://industrial.panasonic.com/ac/e/>

Standard and Amber sealed types

- 1) Plug-in type
- 1 Form C

CAD Data



External dimensions

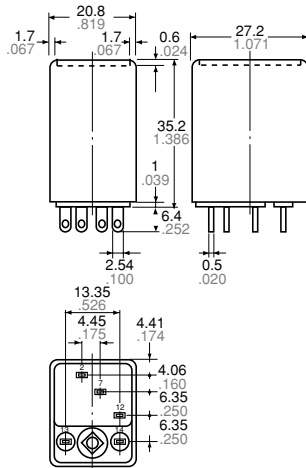

Schematic (Bottom view)

Standard type

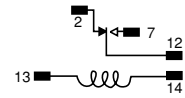

LED AC type

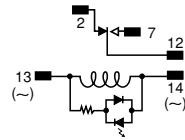

LED DC type

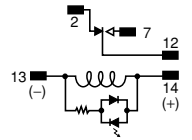

General tolerance: $\pm 0.3 \pm 0.12$

2 Form C

CAD Data



External dimensions

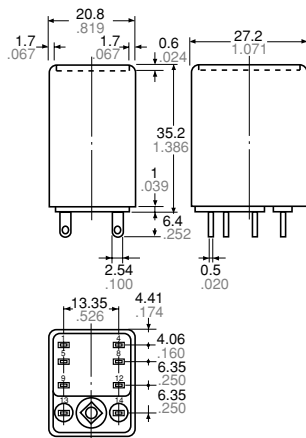

Schematic (Bottom view)

Standard type

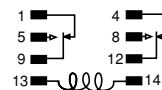

LED AC type

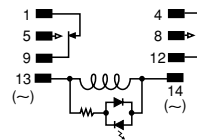

LED DC type

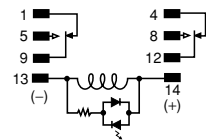

General tolerance: $\pm 0.3 \pm 0.12$

3 Form C

CAD Data



External dimensions

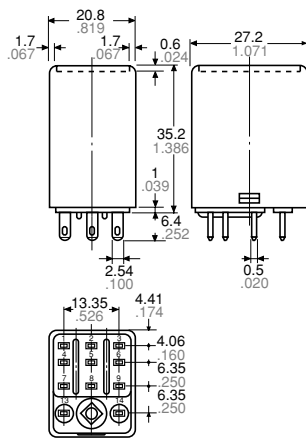

Schematic (Bottom view)

Standard type

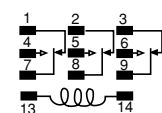

LED AC type

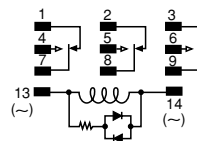

LED DC type

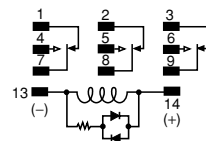

General tolerance: $\pm 0.3 \pm 0.12$

HC

4 Form C and 4-pole bifurcated (twin)

CAD Data



External dimensions

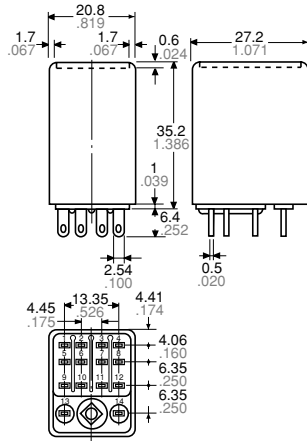

Schematic (Bottom view)

Standard type

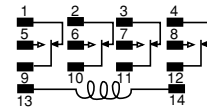

LED AC type

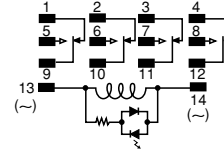

LED DC type

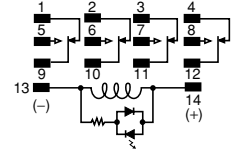

General tolerance: $\pm 0.3 \pm 0.12$

2) PC board type 4 Form C

CAD Data



External dimensions

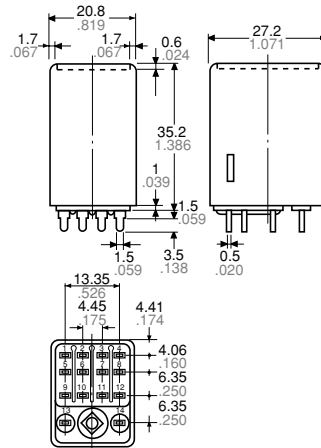

The diagrams show the external dimensions of the 4 Form C and 4-pole bifurcated (twin) types. For 1 Form C, 2 Form C, and 3 Form C, see diagrams at plug-in types (only the terminals are different). Types with 0.9 mm terminal width are also available.

General tolerance: $\pm 0.3 \pm 0.12$

PC board pattern

1 Form C

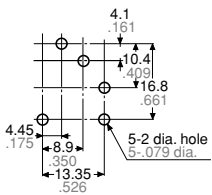

2 Form C

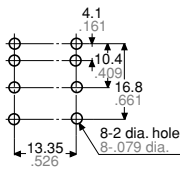

3 Form C

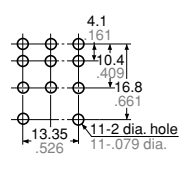

4 Form C

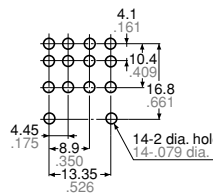

Tolerance: $\pm 0.1 \pm 0.04$

Schematic

Same schematic as plug-in type HC relay

3) TM type
4 Form C

CAD Data

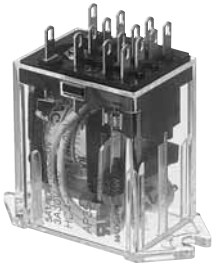

External dimensions

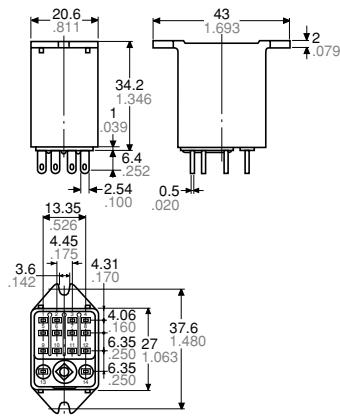

General tolerance: $\pm 0.3 \pm 0.12$

The diagrams show the external dimensions of the 4 Form C and 4-pole bifurcated (twin) types. For 1 Form C, 2 Form C, and 3 Form C, see diagrams at plug-in types (only the terminals are different).

Chassis (Panel) cutout

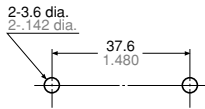

Tolerance: $\pm 0.1 \pm 0.04$

Chassis (Panel) cutout in tandem mounting

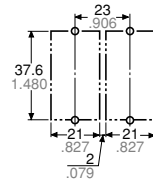

Schematic

Same schematic as plug-in type HC relay
Be aware that there is no LED indicator with built-in diode types.

- Notes: 1. In mounting, use M3 screws and M3 washers.
2. When mounting TM types, use washers to prevent damage or distortion to the polycarbonate cover.
3. When tightening fixing screws, the optimum torque range should be 0.294 to 0.49 N-m, (3 to 5 kgf-cm).
Moreover, use washers to prevent loosening.

With diode type (For DC)

Same dimensions as HC relay standard/plug-in type

CAD Data



Schematic

Without LED indicator

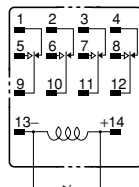

Protection (surge-absorbing) diode

With LED indicator

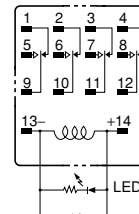

Protection (surge-absorbing) diode

SAFETY STANDARDS

| Item | UL/C-UL (Recognized) | | CSA (Certified) | | VDE (Certified) | | TV rating (UL/CSA) | | Remarks | |
|-----------------------------|----------------------|--|-----------------|--|-----------------|--|--------------------------------|--------|---------|--|
| | File No. | Contact rating | File No. | Contact rating | File No. | Contact rating | File No. | Rating | | |
| HC Standard | 1 Form C | E43028 10A 250V AC 1/3HP 125, 250V AC 3A 30V DC | LR26550 etc. | 10A 250V AC 1/3HP 125, 250V AC 3A 30V DC | 40017406 | 10A 250V AC (cosφ=1.0) 3A 250V AC (cosφ=0.4) 3A 30V DC (0ms) | UL E43149 CSA LR26550 | TV-3 | | |
| | 2 Form C | E43028 7A 250V AC 1/6HP 125, 250V AC 3A 30V DC | LR26550 etc. | 7A 250V AC 1/6HP 125, 250V AC 3A 30V DC | 40017406 | 7A 250V AC (cosφ=1.0) 2A 250V AC (cosφ=0.4) 3A 30V DC (0ms) | UL E43149 CSA LR26550 | TV-3 | | |
| | 3 Form C | E43028 7A 250V AC 1/6HP 125, 250V AC 3A 30V DC | LR26550 etc. | 7A 250V AC 1/6HP 125, 250V AC 3A 30V DC | — | — | — | — | — | |
| | 4 Form C | E43028 5A 250V AC 1/10HP 125, 250V AC 3A 30V DC | LR26550 etc. | 5A 250V AC 1/10HP 125, 250V AC 3A 30V DC | 40017406 | 5A 65V AC (cosφ=1.0) 3A 65V AC (cosφ=0.4) 3A 30V DC (0ms) | — | — | — | |
| | 4 Form C twin | E43149 3A 250V AC 3A 30V DC | LR26550 etc. | 3A 250V AC 3A 30V DC | — | — | — | — | — | |
| HC Amber | 1 Form C | E43028 6A 250V AC 1/6HP 125, 250V AC 3A 30V DC | LR26550 etc. | 6A 250V AC 1/6HP 125, 250V AC 3A 30V DC | — | — | — | — | — | |
| | 2 Form C | E43028 4A 250V AC 1/10HP 125, 250V AC 3A 30V DC | LR26550 etc. | 4A 250V AC 1/10HP 125, 250V AC 3A 30V DC | — | — | — | — | — | |
| | 4 Form C | E43028 2A 250V AC 1/20HP 125, 250V AC 2A 30V DC | LR26550 etc. | 2A 250V AC 1/20HP 125, 250V AC 2A 30V DC | — | — | — | — | — | |
| | 4 Form C twin | E43149 1A 250V AC 1A 30V DC | LR26550 etc. | 1A 250V AC 1A 30V DC | — | — | — | — | — | |
| HC with diode type (For DC) | 1 Form C | E43028 10A 250V AC 1/3HP 125, 250V AC 3A 30V DC | LR26550 etc. | 10A 250V AC 1/3HP 125, 250V AC 3A 30V DC | — | — | — | — | — | |
| | 2 Form C | E43028 7A 250V AC 1/6HP 125, 250V AC 3A 30V DC | LR26550 etc. | 7A 250V AC 1/6HP 125, 250V AC 3A 30V DC | — | — | — | — | — | |
| | 3 Form C | E43028 7A 250V AC 1/6HP 125, 250V AC 3A 30V DC | LR26550 etc. | 7A 250V AC 1/6HP 125, 250V AC 3A 30V DC | — | — | — | — | — | |
| | 4 Form C | E43028 5A 250V AC 1/10HP 125, 250V AC 3A 30V DC | LR26550 etc. | 5A 250V AC 1/10HP 125, 250V AC 3A 30V DC | — | — | — | — | — | |
| | 4 Form C twin | E43149 3A 250V AC 3A 30V DC | LR26550 etc. | 3A 250V AC 3A 30V DC | — | — | — | — | — | |

NOTES

1. Amber sealed type

When mounting TM types, use washers to prevent damage or distortion to the polycarbonate cover. When tightening fixing screws, the optimum torque range should be 0.294 to 0.49 N·m, (3 to 5 kgf·cm). If screws are over tightened, the cover may distort, resulting in poor sealing. Moreover, to prevent loosening, use washers.

2. Diode characteristics

- 1) Reverse breakdown voltage: 1,000 V
- 2) Forward current: 1 A

3. Please connect DC coil types with LED and built-in diode correctly by verifying the coil polarity (“+” and “-”). Connecting with reverse polarity will cause the LED not to light and damage the built-in diode due to its specification.

X-ON Electronics

Largest Supplier of Electrical and Electronic Components

Click to view similar products for [General Purpose Relays](#) category:

Click to view products by [Panasonic](#) manufacturer:

Other Similar products are found below :

[JVN1AF-4.5V-F](#) [PCN-105D3MHZ](#) [5JO-10000S-SIL](#) [5JO-1000CD-SIL](#) [5JO-400CD-SIL](#) [LY2S-AC220/240](#) [LYQ20DC12](#) [6031007G](#)
[6131406HQ](#) [6-1393099-8](#) [6-1393122-4](#) [6-1393123-2](#) [6-1393767-1](#) [6-1393843-7](#) [6-1415012-1](#) [6-1419102-2](#) [6-1423698-4](#) [6-1608051-6](#) [6-1608067-0](#) [6-1616170-6](#) [6-1616248-2](#) [6-1616282-3](#) [6-1616348-2](#) [6-1616349-9](#) [6-1616350-1](#) [6-1616350-8](#) [6-1616358-7](#) [6-1616359-9](#) [6-1616360-9](#) [6-1616931-6](#) [6-1617039-1](#) [6-1617052-1](#) [6-1617090-2](#) [6-1617090-5](#) [6-1617347-5](#) [6-1617353-3](#) [6-1617801-8](#) [6-1618107-9](#) [6-1618248-4](#) [CX-4014](#) [MAHC-5494](#) [MAVCD-5419-6](#) [703XCX-120A](#) [7-1393100-5](#) [7-1393111-7](#) [7-1393767-8](#) [7-1414968-8](#) [7-1419130-3](#) [7-1608047-2](#) [7-1608065-1](#)