

JS RELAYS

Cubic type, 1 Form A/1 Form C 10 A, Power relays

Protective construction : Flux-resistant/Sealed

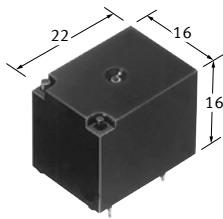

(Unit : mm)

FEATURES

- Universal terminal pitch
- Excellent heat resistance and tracking performance: EN60335-1 GWT compliant (Tested by VDE)
- Surge voltage 6 kV type also available
- Low operating power: 400 mW/200 mW (High sensitivity type)
- TMP type/PC board terminal

TYPICAL APPLICATIONS

- Home appliance
- Vending machine
- Office machine

ORDERING INFORMATION (PART NO.)

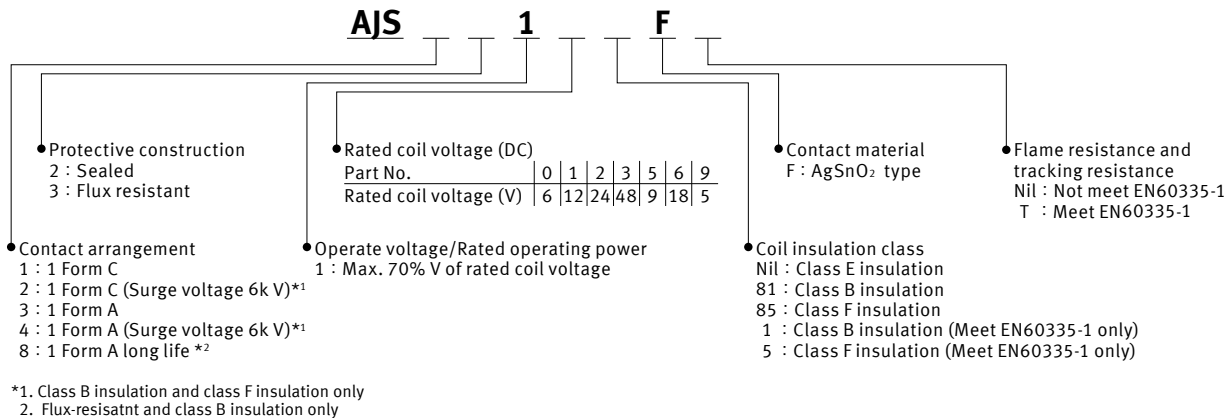

ORDERING INFORMATION (TYPE NO.)

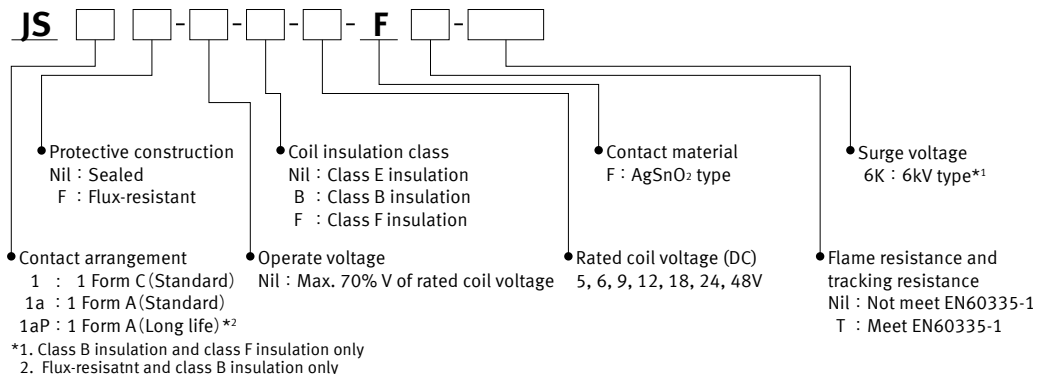

Power relay (Over 2 A) JS RELAYS

TYPES

Contact arrangement	Rated coil voltage	Sealed		Flux-resistant		Standard packing	
		Type No.	Part No.	Type No.	Part No.	Inner carton	Outer carton
1 Form A	5 V DC	JS1a-5V-F	AJS3319F	JS1aF-5V-F	AJS3219F	100 pcs.	500 pcs.
	6 V DC	JS1a-6V-F	AJS3310F	JS1aF-6V-F	AJS3210F		
	9 V DC	JS1a-9V-F	AJS3315F	JS1aF-9V-F	AJS3215F		
	12 V DC	JS1a-12V-F	AJS3311F	JS1aF-12V-F	AJS3211F		
	18 V DC	JS1a-18V-F	AJS3316F	JS1aF-18V-F	AJS3216F		
	24 V DC	JS1a-24V-F	AJS3312F	JS1aF-24V-F	AJS3212F		
	48 V DC	JS1a-48V-F	AJS3313F	JS1aF-48V-F	AJS3213F		
1 Form A Long life	5 V DC	-	-	JS1aPF-B-5V-F	AJS821981F		
	6 V DC	-	-	JS1aPF-B-6V-F	AJS821081F		
	9 V DC	-	-	JS1aPF-B-9V-F	AJS821581F		
	12 V DC	-	-	JS1aPF-B-12V-F	AJS821181F		
	18 V DC	-	-	JS1aPF-B-18V-F	AJS821681F		
	24 V DC	-	-	JS1aPF-B-24V-F	AJS821281F		
1 Form C	5 V DC	JS1-5V-F	AJS1319F	JS1F-5V-F	AJS1219F		
	6 V DC	JS1-6V-F	AJS1310F	JS1F-6V-F	AJS1210F		
	9 V DC	JS1-9V-F	AJS1315F	JS1F-9V-F	AJS1215F		
	12 V DC	JS1-12V-F	AJS1311F	JS1F-12V-F	AJS1211F		
	18 V DC	JS1-18V-F	AJS1316F	JS1F-18V-F	AJS1216F		
	24 V DC	JS1-24V-F	AJS1312F	JS1F-24V-F	AJS1212F		
	48 V DC	JS1-48V-F	AJS1313F	JS1F-48V-F	AJS1213F		

Notes: 1. Class B and F coil insulation types available. Ex) JS1aF-B-12V-F, JS1aF-F-12V-F

2. EN60335-1 GWT compliant types available. When ordering, please add suffix "T". Ex) JS1aF-B-12V-FT

Surge voltage 6kV types available. When ordering, please add suffix "6K" (except for Long endurance type and EN60335-1 GWT compliant type). Ex) JS1aF-B-12V-F-6K

RATING

Coil data

- Operating characteristics such as 'Operate voltage' and 'Release voltage' are influenced by mounting conditions, ambient temperature, etc.

Therefore, please use the relay within $\pm 5\%$ of rated coil voltage.

- 'Initial' means the condition of products at the time of delivery.

Rated coil voltage	Operate voltage*1 (at 20°C)	Release voltage*1 (at 20°C)	Rated operating current ($\pm 10\%$, at 20°C)	Coil resistance ($\pm 10\%$, at 20°C)	Rated operating power	Max. allowable voltage
5 V DC	Max. 70% V of rated coil voltage (Initial)	Min. 10% V of rated coil voltage (Initial)	72 mA	69.4 Ω	360 mW	130% V of rated coil voltage (at 70°C: Class E) 130% V of rated coil voltage (at 85°C: Class B, F)*2
6 V DC			60 mA	100 Ω		
9 V DC			40 mA	225 Ω		
12 V DC			30 mA	400 Ω		
18 V DC			20 mA	900 Ω		
24 V DC			15 mA	1,600 Ω		
48 V DC			7.5 mA	6,400 Ω		

*1. square, pulse drive

*2. The operate and release voltages rise approximately 0.4% for every 1°C given a standard ambient temperature of 20°C.

Therefore, when using relays where the ambient temperature is high, please take into consideration the rise in operate voltage and keep the coil applied voltage within the maximum allowable applied voltage.

■ Specifications

Item		Specifications	
Contact data	Contact arrangement	1 Form A, 1 Form C	1 Form A Long life
	Contact resistance (initial)	Max. 100 mΩ (by voltage drop 6 V DC 1 A)	
	Contact material	AgSnO ₂ type	
	Contact rating (resistive)	10 A 125 V AC, 6 A 277 V AC, 10 A 250 V AC (N.O. only), 5 A 30 V DC	10 A 125 V AC, 10 A 277 V AC, 5 A 30 V DC
	Max. switching power (resistive)	2,500 VA 150 W (N.O.), 1,662 VA 150 W (N.C.)	2,770 VA 150 W
	Max. switching voltage	277 V AC, 100 V DC (0.5 A)	
	Max. switching current	10 A (AC), 5 A (DC)	
	Min. switching load (reference value)*1	100 mA 5 V DC	
Insulation resistance (initial)		Min. 100 MΩ (at 500 V DC, Measured portion is the same as the case of dielectric strength.)	
Dielectric strength (initial)	Between open contacts	750 Vrms for 1 min (detection current:10 mA)	
	Between contact and coil	1,500 Vrms for 1 min (detection current:10 mA)	
Time characteristics (initial)	Operate time	Max. 10 ms (at rated coil voltage, at 20°C, without bounce)	
	Release time	Max. 10 ms (at rated coil voltage, at 20°C, without bounce, without diode)	
Shock resistance	Functional	Min. 98 m/s ² (half-sine shock pulse: 11 ms, detection time: 10 μs)	
	Destructive	Min. 980 m/s ² (half-sine shock pulse: 6 ms)	
Vibration resistance	Functional	10 to 55 Hz (at double amplitude of 1.6 mm, detection time: 10 μs)	
	Destructive	10 to 55 Hz (at double amplitude of 2 mm)	
Expected life	Mechanical life	Min. 10 ⁷ (switching frequency: 180 times/min)	
Conditions	Conditions for usage, transport and storage*2	Ambient temperature: -40 to +70°C (Class E), -40 to +85°C (Class B)*3, -40 to +105°C (Class F)*3 Humidity: 5 to 85% RH (Avoid icing and condensation)	Ambient temperature: -40 to +85°C (Class B)*3 Humidity: 5 to 85% RH (Avoid icing and condensation)
Unit weight		Approx. 12 g	

*1. This value can change due to the switching frequency, environmental conditions, and desired reliability level, therefore it is recommended to check this with the actual load.

*2. For ambient temperature, please read "GUIDELINES FOR RELAY USAGE".

*3. The operate and release voltages rise approximately 0.4% for every 1°C given a standard ambient temperature of 20°C.

Therefore, when using relays where the ambient temperature is high, please take into consideration the rise in operate voltage and keep the coil applied voltage within the maximum allowable applied voltage.

■ Expected electrical life

Conditions: Resistive load, at 20°C, 20 times/min

Type	Switching capacity	Number of operations
1 Form A, 1 Form C	10 A 125 V AC	Min. 10 ⁵
	6 A 277 V AC	Min. 10 ⁵
	5 A 30 V DC	Min. 10 ⁵
	10 A 250 V AC*	Min. 5 x 10 ⁴
1 Form A Long life	10 A 277 V AC	Min. 2 x 10 ⁵
	5 A 30 V DC	Min. 10 ⁵

*N.O. only

REFERENCE DATA

1. Max. switching capacity

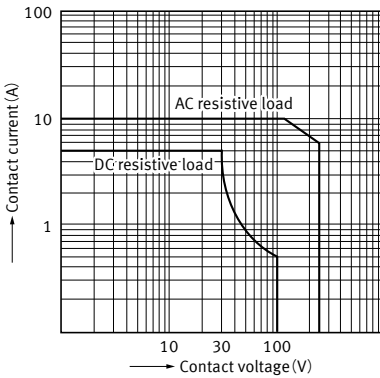

2. Switching life curve

Ambient temperature : Room temperature

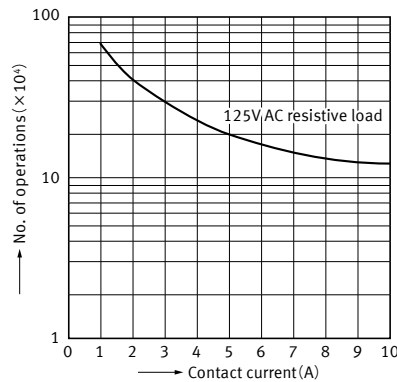

3-1. Coil temperature characteristics (Average)

Tested sample : JS1a-24V-F
Measured portion : Coil inside
Contact current : 5A

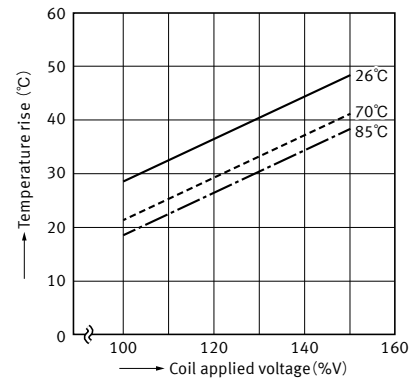

3-2. Coil temperature characteristics (Average)

Tested sample : JS1a-24V-F
Measured portion : Coil inside
Contact current : 10A

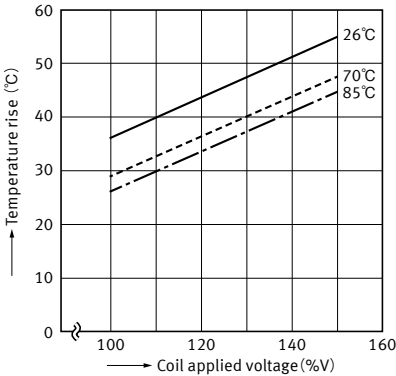

4. Ambient temperature characteristics (Average)

Tested sample : JS1-12V-F, 6 pcs.

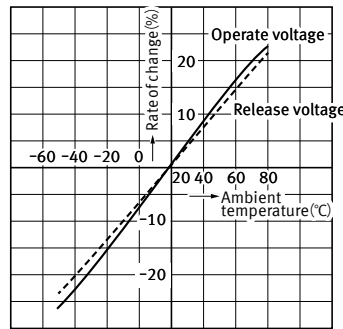

5. Operate and release time characteristics

Tested sample : JS1-12V-F, 25 pcs.

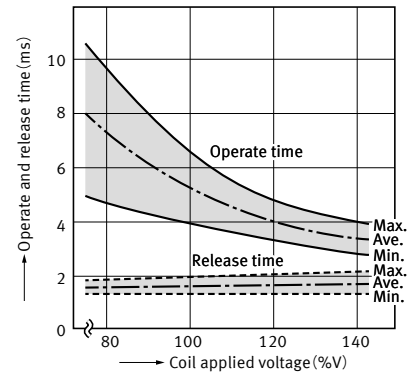

DIMENSIONS

CAD The CAD data of the products with a "CAD" mark can be downloaded from our Website.

Unit: mm

CAD

External dimensions

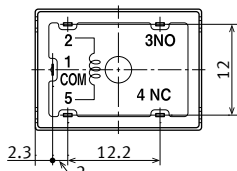
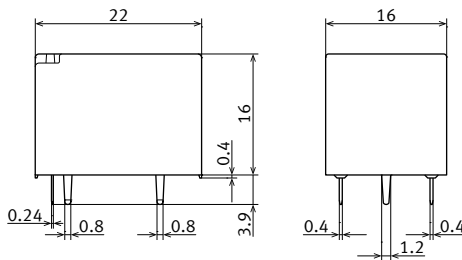

General tolerance
Less than 1mm : ±0.1
Min. 1mm less than 3mm : ±0.2
Min. 3mm : ±0.3

Note : Terminal No.4 is only for Standard 1 Form C type.

Recommended PC board pattern (BOTTOM VIEW)

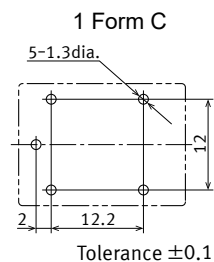
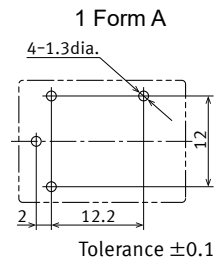

Schematic (BOTTOM VIEW)

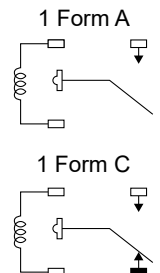

SAFETY STANDARDS

■ UL/C-UL (Recognized)

File No.	Contact rating	Operations	Ambient temperature
E43028	12 A 125 V AC	10 ⁵	70°C
	10 A 125 V AC (N.C.)	–	–
	10 A 125 V AC (N.O.)	10 ⁵	85°C
	6 A 277 V AC	10 ⁵	–
	5 A 30 V DC	10 ⁵	–
	½ HP 125 V AC	10 ⁵	–
	½ HP 277 V AC	10 ⁴	–
	½ HP 277 V AC (N.O.)	10 ⁵	75°C
	4FLA/4LRA 240 V AC (N.O.)	10 ⁵	105°C
	2FLA/4LRA 240 V AC (N.C.)	3×10 ⁴	105°C

■ VDE (Certified)

File No.	Contact rating	Operations	Ambient temperature
40011475	10 A 125 V AC (cosφ = 1.0)	10 ⁴	70°C
	6 A 250 V AC (cosφ = 1.0)	10 ⁵	70°C

Note: UL, CSA, VDE (Long life type and EN60335-1 GWT compliant type)
UL, CSA (Surge voltage 6kV type)

■ CQC (Certified)

File No.	Contact rating
CQC10002041728	10A 250V AC (N.O.)
	6A 250V AC (N.C.)

■ CSA (Certified)

File No.	Contact rating	Operations
LR26550	12 A 125 V AC	10 ⁵
	10 A 125 V AC	10 ⁵
	6 A 277 V AC	10 ⁵
	5 A 30 V DC	10 ⁵
	½ HP 125 V AC	10 ⁵
	½ HP 277 V AC	10 ⁵

■ TÜV (Certified)

File No.	Contact rating	Operations
B18 03 13461 377	10 A 125 V AC (cosφ = 1.0)	10 ⁵
	6 A 250 V AC (cosφ = 1.0)	10 ⁵

GUIDELINES FOR USAGE

- For cautions for use, please read "GUIDELINES FOR RELAY USAGE".
https://industrial.panasonic.com/ac/e/control/relay/cautions_use/index.jsp

Please refer to **"the latest product specifications"** when designing your product.
•Requests to customers:
<https://industrial.panasonic.com/ac/e/salespolicies/>

GUIDELINES FOR POWER, HIGH-CAPACITY DC CUT OFF AND SAFETY RELAYS USAGE

■ For cautions for use, please read “GUIDELINES FOR RELAY USAGE”.
https://industrial.panasonic.com/ac/e/control/relay/cautions_use/index.jsp

Precautions for Coil Input

■ Long term current carrying

A circuit that will be carrying a current continuously for long periods without relay switching operation. (circuits for emergency lamps, alarm devices and error inspection that, for example, revert only during malfunction and output warnings with form B contacts)
Continuous, long-term current to the coil will facilitate deterioration of coil insulation and characteristics due to heating of the coil itself. For circuits such as these, please use a magnetic-hold type latching relay. If you need to use a single stable relay, use a sealed type relay that is not easily affected by ambient conditions and make a failsafe circuit design that considers the possibility of contact failure or disconnection.

■ DC Coil operating power

Steady state DC current should be applied to the coil. The wave form should be rectangular. If it includes ripple, the ripple factor should be less than 5%.

However, please check with the actual circuit since the electrical characteristics may vary. The rated coil voltage should be applied to the coil and the set/reset pulse time of latching type relay differs for each relays, please refer to the relay's individual specifications.

■ Coil connection

When connecting coils of polarized relays, please check coil polarity (+,-) at the internal connection diagram (Schematic). If any wrong connection is made, it may cause unexpected malfunction, like abnormal heat, fire and so on, and circuit do not work. Avoid impressing voltages to the set coil and reset coil at the same time.

■ Maximum allowable voltage and temperature rise

Proper usage requires that the rated coil voltage be impressed on the coil. Note, however, that if a voltage greater than or equal to the maximum continuous voltage is impressed on the coil, the coil may burn or its layers short due to the temperature rise. Furthermore, do not exceed the usable ambient temperature range listed in the catalog.

■ Operate voltage change due to coil temperature rise

In DC relays, after continuous passage of current in the coil, if the current is turned OFF, then immediately turned ON again, due to the temperature rise in the coil, the pick-up voltage will become somewhat higher. Also, it will be the same as using it in a higher temperature atmosphere. The resistance/temperature relationship for copper wire is about 0.4% for 1°C, and with this ratio the coil resistance increases. That is, in order to operate of the relay, it is necessary that the voltage be higher than the pick-up voltage and the pick-up voltage rises in accordance with the increase in the resistance value. However, for some polarized relays, this rate of change is considerably smaller.

Ambient Environment

■ Usage, Transport, and Storage Conditions

During usage, storage, or transportation, avoid locations subjected to direct sunlight and maintain normal temperature, humidity and pressure conditions.

● Temperature/Humidity/Pressure

When transporting or storing relays while they are tube packaged, there are cases the temperature may differ from the allowable range. In this case be sure to check the individual specifications. Also allowable humidity level is influenced by temperature, please check charts shown below and use relays within mentioned conditions. (Allowable temperature values differ for each relays, please refer to the relay's individual specifications.)

1) Temperature:

The tolerance temperature range differs for each relays, please refer to the relay's individual specifications

2) Humidity: 5 to 85 % RH

3) Pressure: 86 to 106 kPa

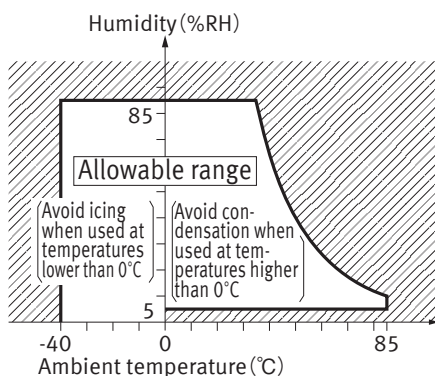

● Dew condensation

Condensation occurs when the ambient temperature drops suddenly from a high temperature and humidity, or the relay is suddenly transferred from a low ambient temperature to a high temperature and humidity. Condensation causes the failures like insulation deterioration, wire disconnection and rust etc. Panasonic Corporation does not guarantee the failures caused by condensation.

The heat conduction by the equipment may accelerate the cooling of device itself, and the condensation may occur.

Please conduct product evaluations in the worst condition of the actual usage. (Special attention should be paid when high temperature heating parts are close to the device. Also please consider the condensation may occur inside of the device.)

● Icing

Condensation or other moisture may freeze on relays when the temperature become lower than 0°C. This icing causes the sticking of movable portion, the operation delay and the contact conduction failure etc. Panasonic Corporation does not guarantee the failures caused by the icing.

The heat conduction by the equipment may accelerate the cooling of relay itself and the icing may occur. Please conduct product evaluations in the worst condition of the actual usage.

● Low temperature and low humidity

The plastic becomes brittle if the switch is exposed to a low temperature, low humidity environment for long periods of time.

● High temperature and high humidity

Storage for extended periods of time (including transportation periods) at high temperature or high humidity levels or in atmospheres with organic gases or sulfide gases may cause a sulfide film or oxide film to form on the surfaces of the contacts and/or it may interfere with the functions. Check out the atmosphere in which the units are to be stored and transported.

● Package

In terms of the packing format used, make every effort to keep the effects of moisture, organic gases and sulfide gases to the absolute minimum.

● Silicon

When a source of silicone substances (silicone rubber, silicone oil, silicone coating materials and silicone filling materials etc.) is used around the relay, the silicone gas (low molecular siloxane etc.) may be produced.

This silicone gas may penetrate into the inside of the relay. When the relay is kept and used in this condition, silicone compound may adhere to the relay contacts which may cause the contact failure.

Do not use any sources of silicone gas around the relay (Including plastic seal types).

● NOx Generation

When relay is used in an atmosphere high in humidity to switch a load which easily produces an arc, the NOx created by the arc and the water absorbed from outside the relay combine to produce nitric acid.

This corrodes the internal metal parts and adversely affects operation.

Avoid use at an ambient humidity of 85%RH or higher (at 20°C). If use at high humidity is unavoidable, please contact our sales representative.

Others

■ Cleaning

• Although the environmentally sealed type relay (plastic sealed type, etc.) can be cleaned, avoid immersing the relay into cold liquid (such as cleaning solvent) immediately after soldering. Doing so may deteriorate the sealing performance.

• Cleaning with the boiling method is recommended(The temperature of cleaning liquid should be 40°C or lower).

Avoid ultrasonic cleaning on relays. Use of ultrasonic cleaning may cause breaks in the coil or slight sticking of the contacts due to ultrasonic energy.

Please refer to **"the latest product specifications"** when designing your product.

•Requests to customers:

<https://industrial.panasonic.com/ac/e/salespolicies/>

Please contact

Panasonic Corporation

Electromechanical Control Business Division

■1006, Oaza Kadoma, Kadoma-shi, Osaka 571-8506, Japan
industrial.panasonic.com/ac/e/

Panasonic[®]

©Panasonic Corporation 2020

X-ON Electronics

Largest Supplier of Electrical and Electronic Components

Click to view similar products for [Panasonic](#) manufacturer:

Other Similar products are found below :

[ECE-A1HKAR47](#) [ELK-EA102FA](#) [ELC-09D151F](#) [EEC-S0HD224H](#) [ELL-5PS3R3N](#) [HC2-H-DC48V-F](#) [HL2-HP-AC120V-F](#) [HL2-HP-DC12V-F](#) [HL2-HP-DC6V-F](#) [HL2-HP-DC24V-F](#) [HC4-H-DC24V](#) [HL2-HTM-DC24V-F](#) [HL2-HTM-AC24V-F](#) [HC3-HL-AC120V-F](#) [HC4-H-AC120V](#) [AMV9003](#) [EEC-RG0V155H](#) [AZH2031](#) [RP-SDMF64DA1](#) [RP-SDMF32DA1](#) [EEF-UD0K101R](#) [RP-SMLE08DA1](#) [EVM-F6SA00B55](#) [ELC-12D101E](#) [ERA-3YEB272V](#) [EEC-RF0V684](#) [ERA-3YEB153V](#) [ELC-3FN2R2N](#) [ERA-3YEB512V](#) [ERJ-1GEJ564C](#) [ERZ-V20R391](#) [ELL-6RH221M](#) [ETQ-P3W3R3WFN](#) [ELL-ATV681M](#) [ELL-VGG4R7N](#) [EEF-UD0J101R](#) [ECQ-U2A474ML](#) [LC-R121R3P](#) [ELK-EA100FA](#) [EVP-AKB11A](#) [ECQ-U2A154ML](#) [ELK-E101FA](#) [ERA-3YEB303V](#) [ERA-V15J100V](#) [ERZ-V05V680CB](#) [EEF-UE0K101R](#) [EEC-S0HD224V](#) [EVQ-PAC05R](#) [EVQ-PAG04M](#) [ELK-EA222FA](#)