

### Description

LNCT28PF01WW is a MOCVD fabricated 660nm and 780nm band dual wavelength laser diode with multi quantum well structure , adapting open type frame package to reduce the size and weight.

### Feature

- Dual wavelength: 661 nm (typ) and 783 nm (typ)
- High output power: 300 mW (pulse) for Red and 380 mW (pulse) for IR
- Package : Flat package
- Operating temperature : Max. +85°C

### Application

- Optical disk drive
- Sensing
- Industrial use

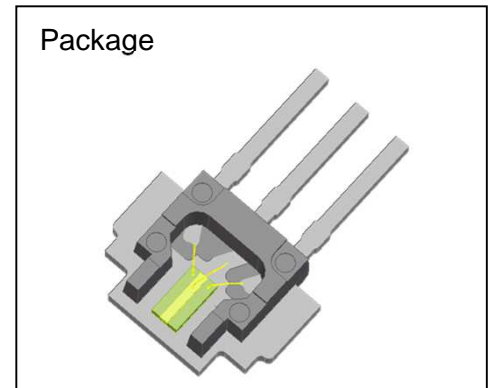

### Absolute Maximum Ratings <sup>3)</sup>

| LD  | Item                       | Symbol | Value      | Unit | Condition           |
|-----|----------------------------|--------|------------|------|---------------------|
| RED | Output power               | Po     | 100        | mW   | CW                  |
|     |                            |        | 300        | mW   | pulse <sup>1)</sup> |
|     | Reverse voltage            | Vr     | 1.5        | V    | CW                  |
|     | Operating case temperature | Tc     | -10 to +85 | °C   | CW/pulse            |
| IR  | Output power               | Po     | 200        | mW   | CW                  |
|     |                            |        | 380        | mW   | pulse <sup>2)</sup> |
|     | Reverse voltage            | Vr     | 1.5        | V    | CW                  |
|     | Operating case temperature | Tc     | -10 to +85 | °C   | CW/pulse            |
|     | Storage temperature        | Tstg   | -40 to +85 | °C   |                     |

Note) 1) Pulse width ≤ 30 ns, duty ≤ 33% for RED-LD

2) Pulse width ≤ 100 ns, duty ≤ 50% for IR-LD

3) These ratings are guaranteed only when RED-LD or IR-LD is turned on individually.

### Electrical and Optical Characteristics

T=25°C, CW, Po=90 mW for RED-LD, 175 mW for IR-LD

| LD            | Item              | Symbol   | Min. | Typ. | Max. | Unit | Condition |
|---------------|-------------------|----------|------|------|------|------|-----------|
| RED           | Threshold current | Ith      | -    | 50   | 80   | mA   |           |
|               | Operating current | Iop      | -    | 128  | 180  | mA   |           |
|               | Operating voltage | Vop      | -    | 2.4  | 3.0  | V    |           |
|               | Wavelength        | λ        | 656  | 661  | 665  | nm   |           |
|               | Beam Divergence   | Parallel | θh   | 7.5  | -    | 13.0 | deg       |
| Perpendicular |                   | θv       | 13.0 | -    | 19.5 | deg  | FWHM      |
| IR            | Threshold current | Ith      | -    | 45   | 70   | mA   |           |
|               | Operating current | Iop      | -    | 210  | 275  | mA   |           |
|               | Operating voltage | Vop      | -    | 2.5  | 3.0  | V    |           |
|               | Wavelength        | λ        | 777  | 783  | 791  | Nm   |           |
|               | Beam divergence   | Parallel | θh   | 6.0  | -    | 11.5 | deg       |
| Perpendicular |                   | θv       | 12.0 | -    | 19.0 | deg  |           |

FWHM : Full width at half maximum

### Representative Characteristics [RED-LD]

Output Power vs Current (CW)

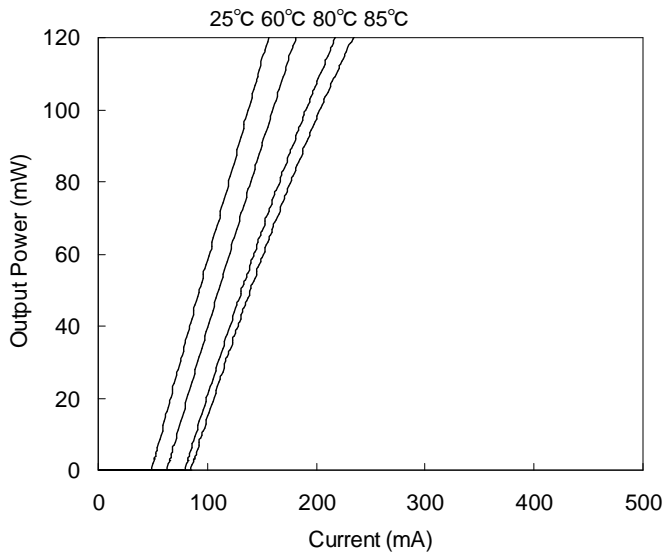

Voltage vs Current (CW)

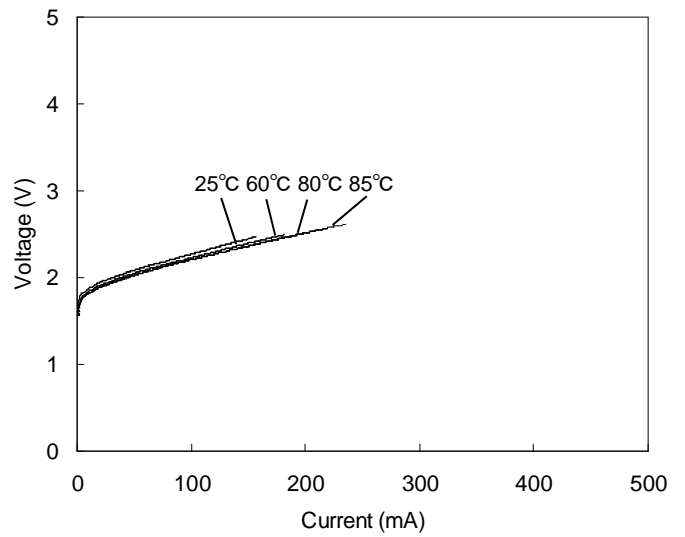

Output Power vs Current (Pulse)

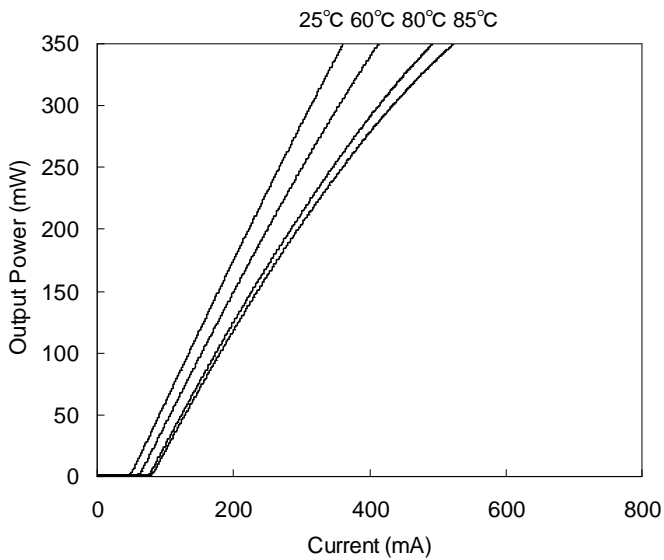

Voltage vs Current (Pulse)

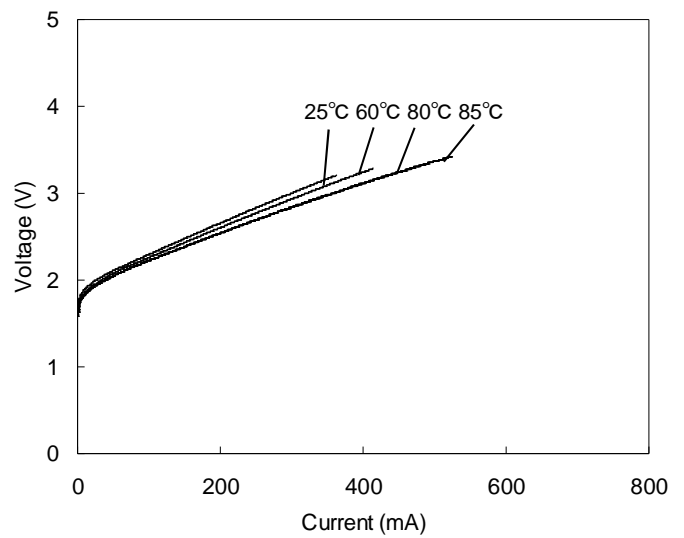

Representative Characteristics [RED-LD]

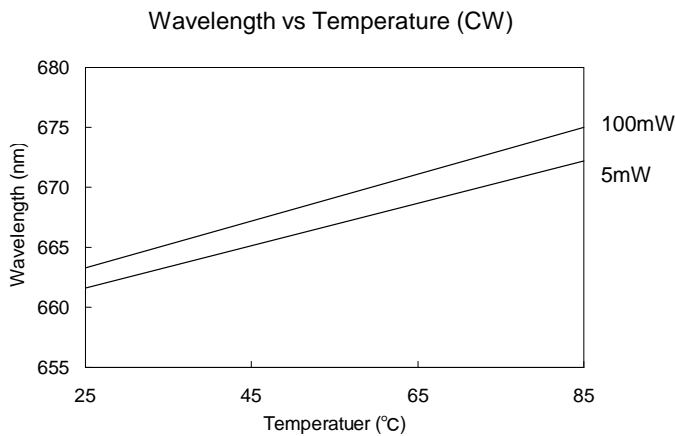
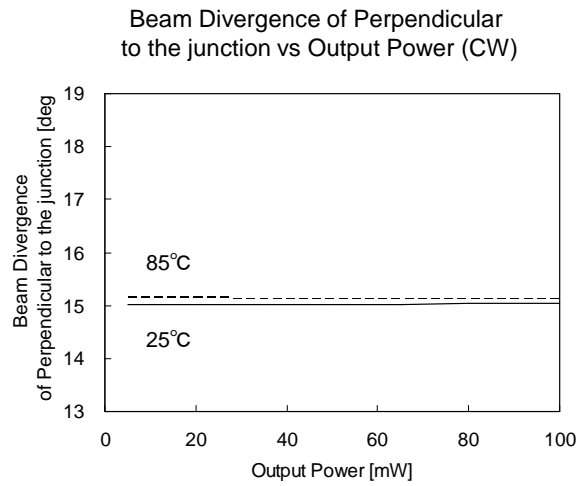
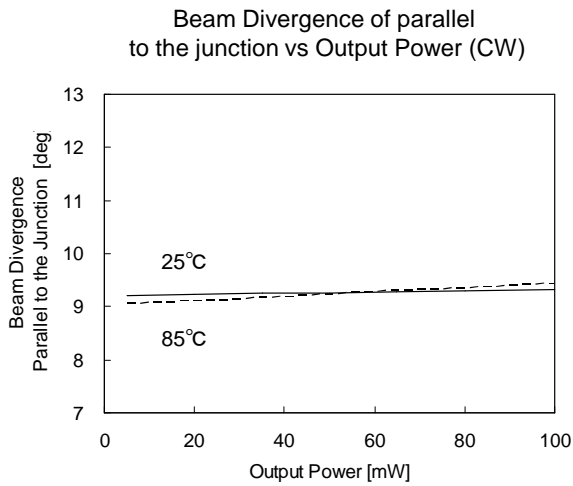
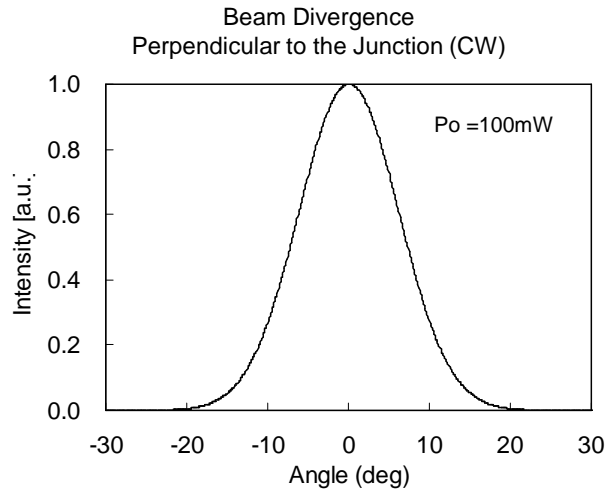
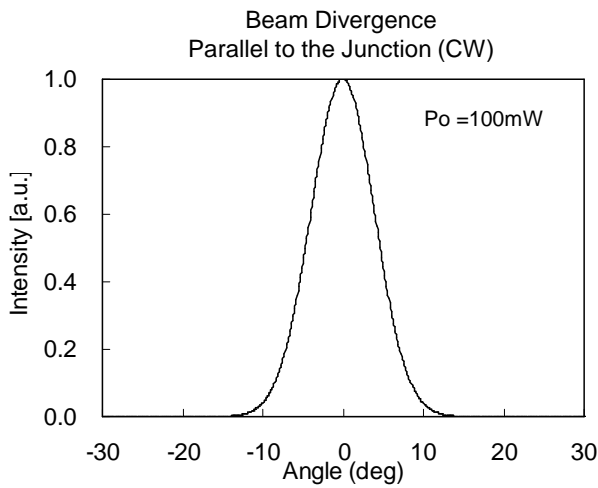

Representative Characteristics [IR-LD]

Output Power vs Current (CW)

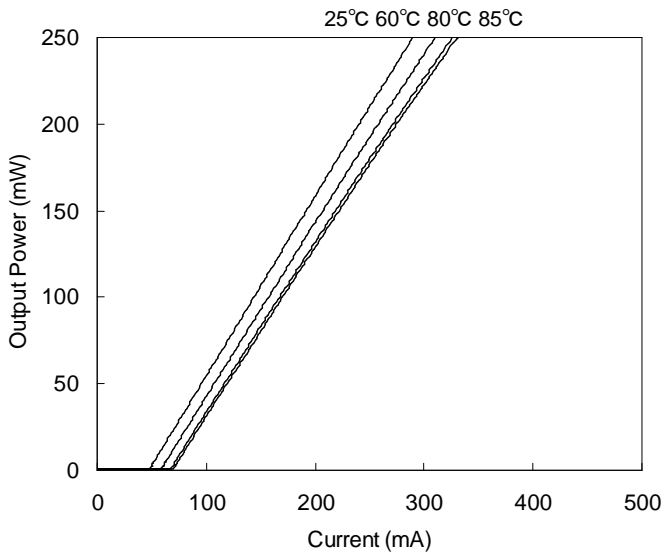

Voltage vs Current (CW)

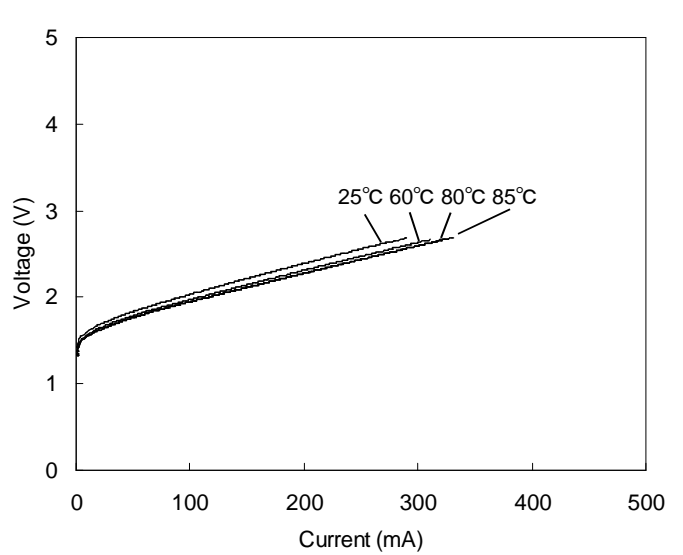

Output Power vs Current (Pulse)

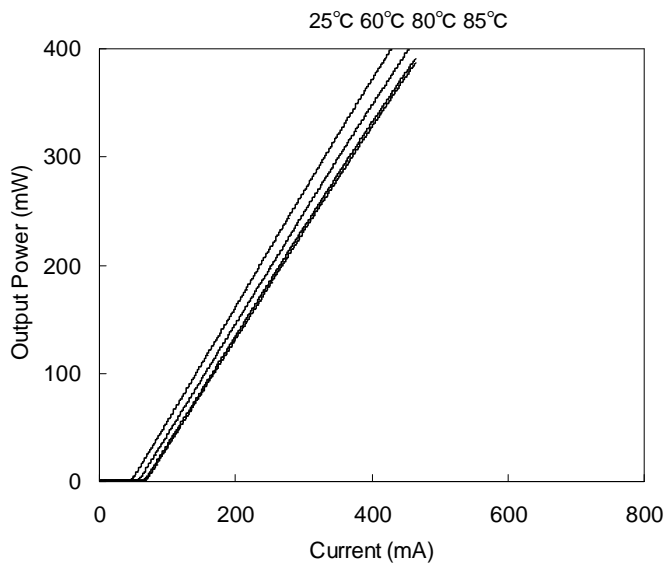

Voltage vs Current (Pulse)

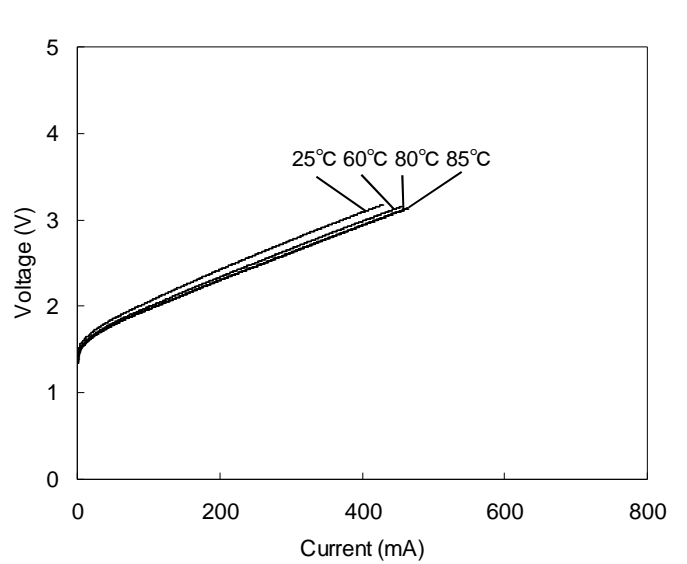

Representative Characteristics [IR-LD]

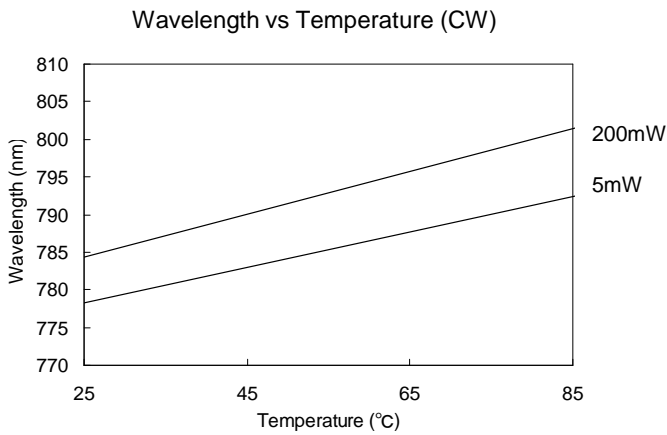
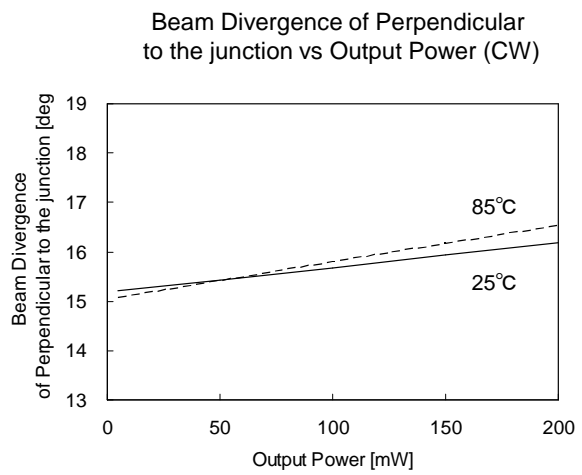
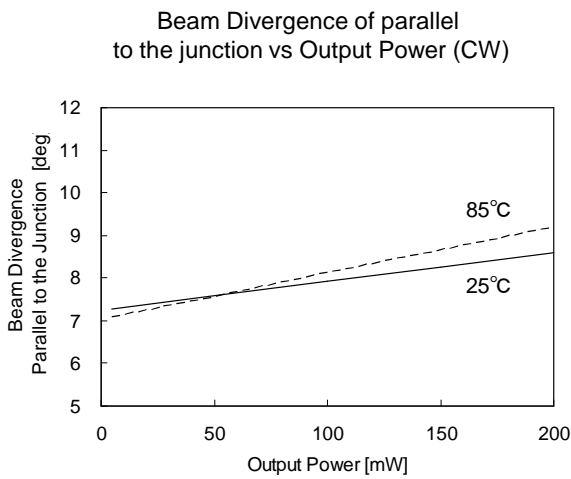
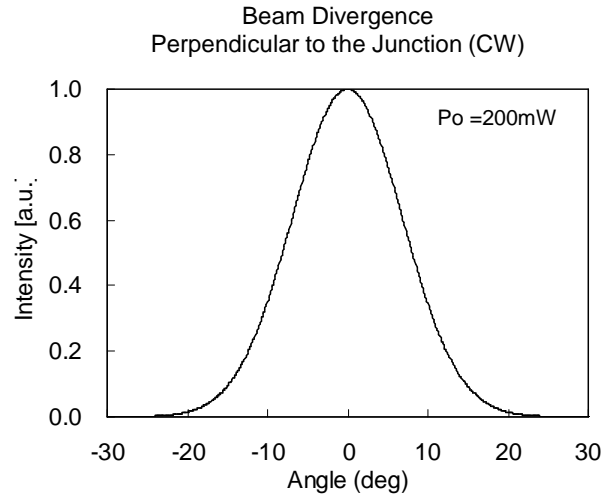
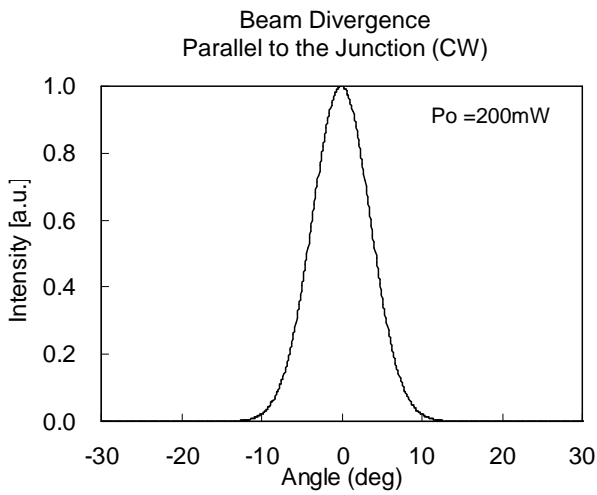

Package Dimensions

Unit: mm

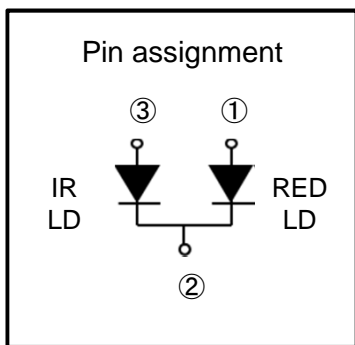
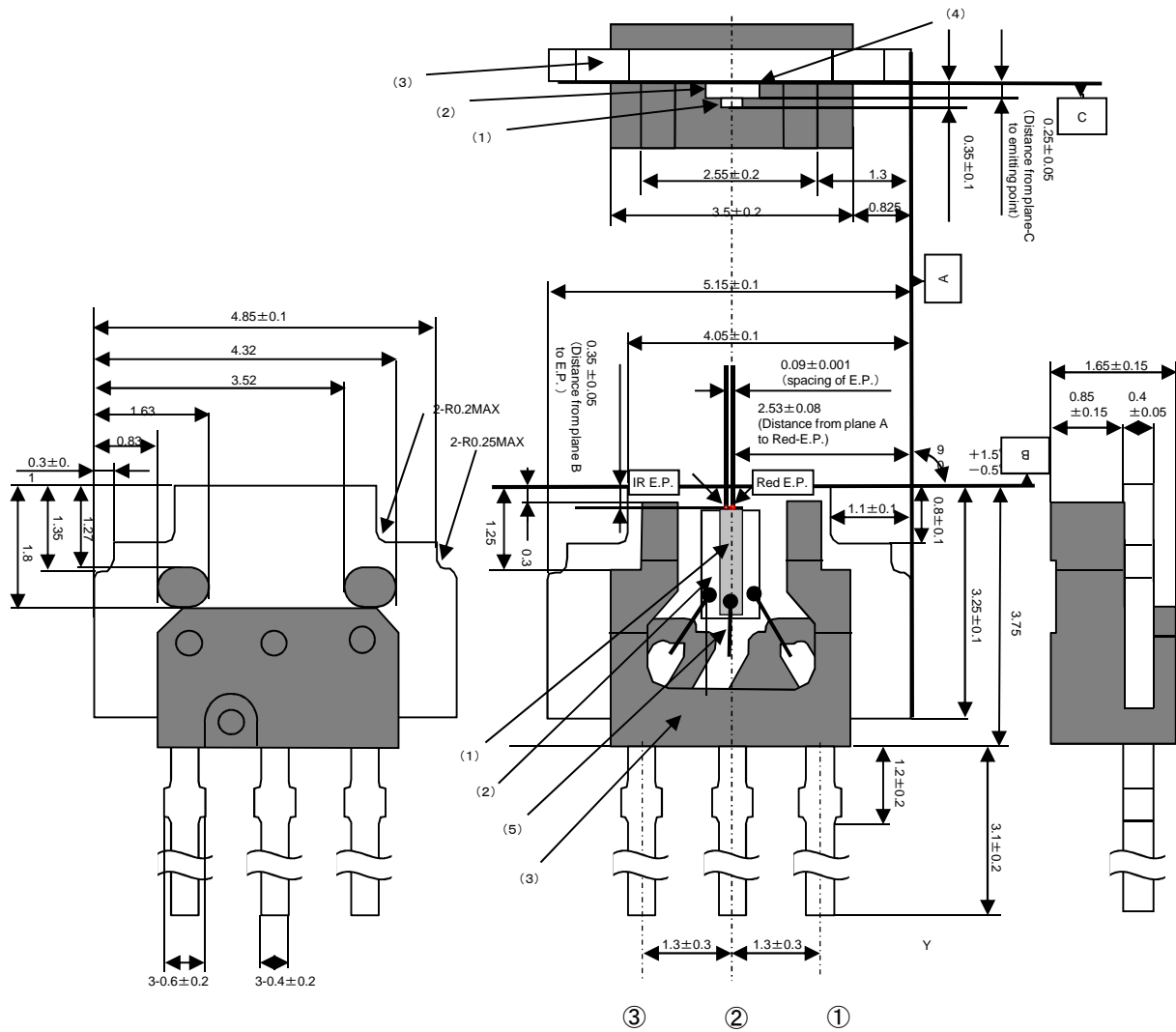

- (1) LD Chip
  - (2) Submount
  - (3) Package
  - (4) Ag Paste
  - (5) Au Wire
- E.P. = Emitting point
  - General corner R is 0.25mm

### Packing Specifications

#### 1 Packing Material

##### 1.1 Tray

Material: Conductive Polystyrene

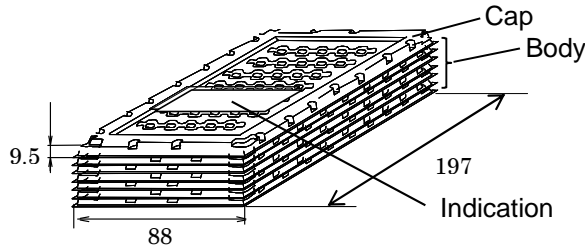

##### 1.2 Laminated Aluminum Cover

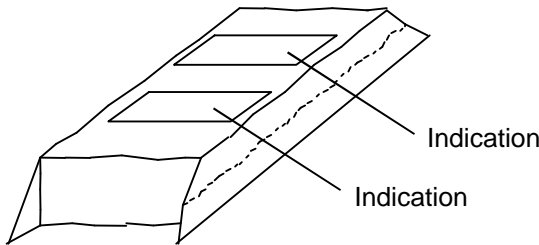

##### 1.3 Packing Case

Material: Card Board Box

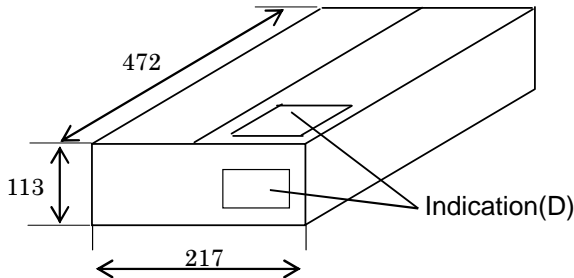

※As for label indication except ①(Order person part number),②(Order person part number and Quantity),③(Serial number and Corporate code),④(Quantity),the information only for our process control, therefore please note that revision without notice might be done due to improvement etc.

#### 1) Indication on Top Tray

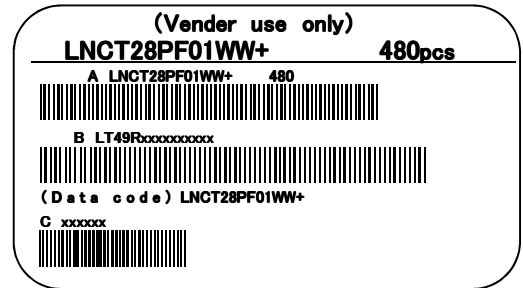

#### 2) Indication on Laminated Pack

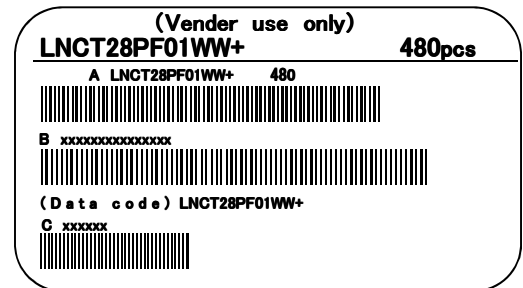
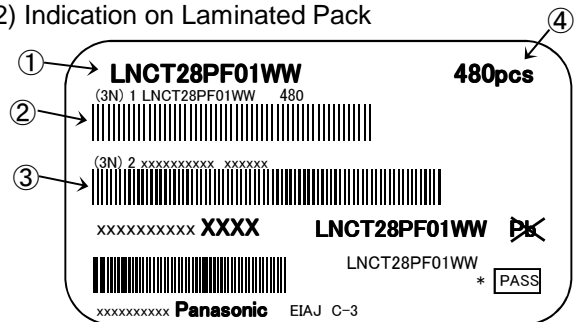

#### 3) Indication on packing case

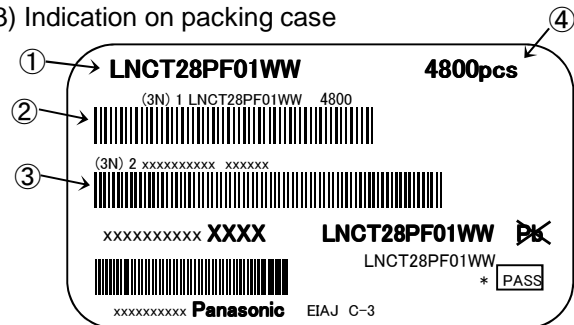

### 2 Packaging Quantity

| Form                     | Quantity | Contents             | Note                               |
|--------------------------|----------|----------------------|------------------------------------|
| Tray                     | n=80     | --                   | --                                 |
| Laminated Aluminum Cover | n=480    | Tray: 7 (Body + Cap) | Wrap The Product and The Desiccant |
| Packing Case             | n=4800   | Aluminum Pack 10     | --                                 |

## Warning

### ■ Laser class

This product is ranked in class IIIb laser according to IEC60825-1 and JIS standard 6802 "Laser Product Emission Safety Standards", so that safety protection is necessary when laser beam is radiated.

## Cautions

### ■ Flat package laser diode (FLD)

This product is adopting open type plastic package for the reduction of size and weight, so please take care of dust and touching laser diode with tweezers.

### ■ Prevention of Electrostatic discharge (ESD) and surge stress

Semiconductor laser diode is sensitive device to ESD and surge, so that sufficient cautions are needed. If electric pulses that may cause emission are inputted, the laser itself will be damaged by light intensity and will bring the laser diode degradation in a short time. Therefore, taking all possible measures against ESD and surge for FLD usage is strongly requested.

### ■ Heat sink design

If case temperature becomes higher, the life of semiconductor laser diode becomes shorter. So it is important that design for heat radiation is appropriated. Especially it is effective to make the heat radiation from metal moiety of the package back side, locating under the submount and laser diode.

### ■ Precaution at soldering

When soldering, please give attention to the mechanical stress and the temperature because of using Ag paste. Temperature of die-pad portion should be less than 200°C. It is recommended to radiate heat by putting heat sink on the package.

#### •Soldering temperature and time

•Temperature : Less than 360°C (FLD only)  
Less than 380°C (FLD with holder for heat radiation)

•Time : Within 5sec (Recommend within 3sec)





# Caution for Safety



**DANGER**

Do not touch or look into the laser beam directly.

The laser beam may cause injury to the eye or skin, or loss of eyesight.

## Request for your special attention and precautions in using the technical information and semiconductors described in this book

- (1) If any of the products or technical information described in this book is to be exported or provided to non-residents, the laws and regulations of the exporting country, especially, those with regard to security export control, must be observed.
- (2) The technical information described in this book is intended only to show the main characteristics and application circuit examples of the products. No license is granted in and to any intellectual property right or other right owned by Panasonic Corporation or any other company. Therefore, no responsibility is assumed by our company as to the infringement upon any such right owned by any other company which may arise as a result of the use of technical information de-scribed in this book.
- (3) The products described in this book are intended to be used for general applications (such as office equipment, communications equipment, measuring instruments and household appliances), or for specific applications as expressly stated in this book.  
Please consult with our sales staff in advance for information on the following applications, moreover please exchange documents separately on terms of use etc.: Special applications (such as for in-vehicle equipment, airplanes, aerospace, automotive equipment, traffic signaling equipment, combustion equipment, medical equipment and safety devices) in which exceptional quality and reliability are required, or if the failure or malfunction of the products may directly jeopardize life or harm the human body.  
Unless exchanging documents on terms of use etc. in advance, it is to be understood that our company shall not be held responsible for any damage incurred as a result of or in connection with your using the products described in this book for any special application.
- (4) The products and product specifications described in this book are subject to change without notice for modification and/or improvement. At the final stage of your design, purchasing, or use of the products, therefore, ask for the most up-to-date Product Standards in advance to make sure that the latest specifications satisfy your requirements.
- (5) When designing your equipment, comply with the range of absolute maximum rating and the guaranteed operating conditions (operating power supply voltage and operating environment etc.). Especially, please be careful not to exceed the range of absolute maximum rating on the transient state, such as power-on, power-off and mode-switching. Otherwise, we will not be liable for any defect which may arise later in your equipment.  
Even when the products are used within the guaranteed values, take into the consideration of incidence of break down and failure mode, possible to occur to semiconductor products. Measures on the systems such as redundant design, arresting the spread of fire or preventing glitch are recommended in order to prevent physical injury, fire, social damages, for example, by using the products.
- (6) Comply with the instructions for use in order to prevent breakdown and characteristics change due to external factors (ESD, EOS, thermal stress and mechanical stress) at the time of handling, mounting or at customer's process. We do not guarantee quality for disassembled products or the product re-mounted after removing from the mounting board.  
When using products for which damp-proof packing is required, satisfy the conditions, such as shelf life and the elapsed time since first opening the packages.
- (7) When reselling products described in this book to other companies without our permission and receiving any claim of request from the resale destination, please understand that customers will bear the burden.
- (8) This book may be not reprinted or reproduced whether wholly or partially, without the prior written permission of our company.

## X-ON Electronics

Largest Supplier of Electrical and Electronic Components

*Click to view similar products for [Laser Diodes](#) category:*

*Click to view products by [Panasonic](#) manufacturer:*

Other Similar products are found below :

[ADL-65055TL](#) [ADL-78101TL](#) [ADL-83Z01TL](#) [ADL-85301TL](#) [PLT3 450C](#) [LCU80B051A](#) [RLD78NzM5-00A](#) [ADL-63054TL](#) [ADL-63102TL-3](#) [ADL-63153TL](#) [ADL-65103TL](#) [ADL-66201TL](#) [LCU66A051A](#) [SPL LL90\\_3](#) [ADL-65075TL](#) [905D1S03UA](#) [905D1S09UA](#) [ADL-63054SL](#) [ADL-63301TL](#) [ADL-63T01NY](#) [ADL-63V0ANP](#) [ADL-65074TA4](#) [ADL-65074TL-1](#) [ADL-65075SL](#) [ADL-65075TA4](#) [ADL-65104TA4](#) [ADL-65104TL](#) [ADL-66201TA4](#) [ADL-83Z51TL](#) [ADL-85051TL](#) [LCU632051A](#) [LCU670561A](#) [LCU982562A](#) [SPL PL90\\_3](#) [RLD63NPC5-00A](#) [RLD63NPC6-00A](#) [RLD63NPC8-00A](#) [RLD63NPC7-00A](#) [RLD78NzM7-00A](#) [RLD65NZX1-00A](#) [RLD65MZT7-00A](#) [RLD65PZX3-00A](#) [RLD82NZJ1-00A](#) [RLD65NZX2-00A](#) [RLD78MzM7-00A](#) [RLD65PZX2-01A](#) [RLD78PzM7-00A](#) [RLD84NZJ2-00A](#) [RLD84PZJ2-00A](#) [RLD85PZJ4-00A](#)