

## Cell Type N-700AAC Specifications

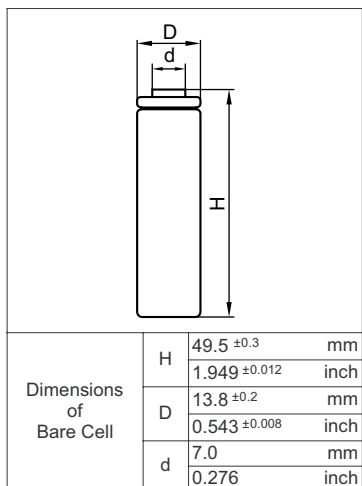

Nominal Capacity		700mAh	
Nominal Voltage		1.2V	
Charging Current	Standard	70mA	
	Quick	210mA	
	Fast	1050mA	
Charging Time	Standard	14 to 16Hrs.	
	Quick	4 to 6Hrs.	
	Fast	about 1Hr.	
Ambient Temperature	Charge	Standard	0°C to +45°C [+32°F to 113°F]
		Quick	10°C to +45°C [+50°F to 113°F]
		Fast	0°C to +45°C [+32°F to 113°F]
	Discharge		-20°C to +60°C [-4°F to 140°F]
	Storage		-30°C to +50°C [-22°F to 122°F]
Internal Impedance (Av.) (at 50% discharge)		16.0mΩ (at 1000Hz)	
Weight		23g/0.81oz	
Dimensions(D)×(H) (with tube)		14.3 <sup>0</sup> <sub>-0.5</sub> × 50.2 <sup>0</sup> <sub>-1</sub>	mm
		0.56 <sup>0</sup> <sub>-0.02</sub> × 1.98 <sup>0</sup> <sub>-0.04</sub>	inch

### Typical Characteristics

Charge

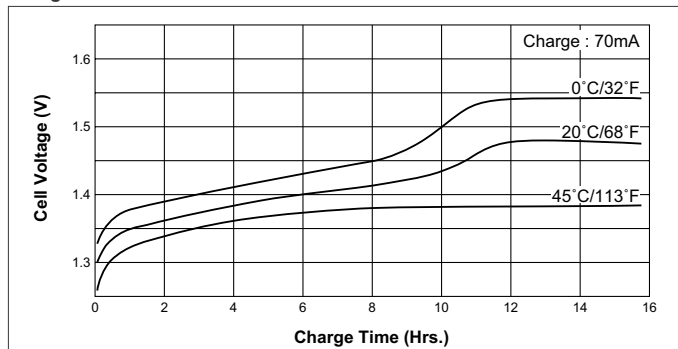

Discharge (at high rate)

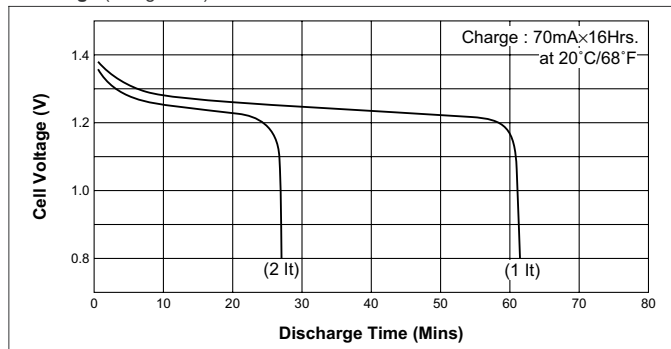

Charge

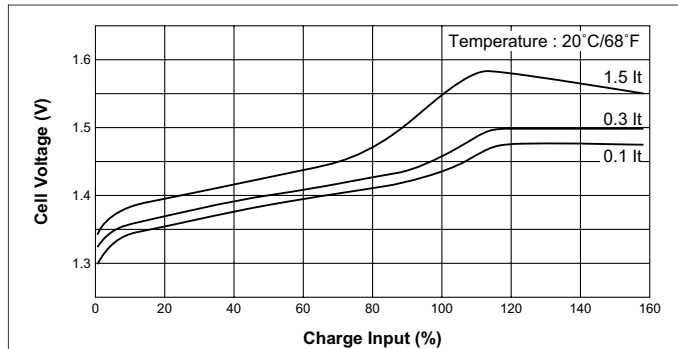

Discharge (at high rate)

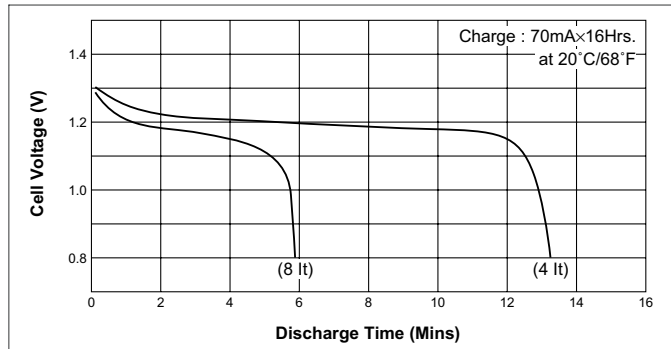

Discharge (at low rate)

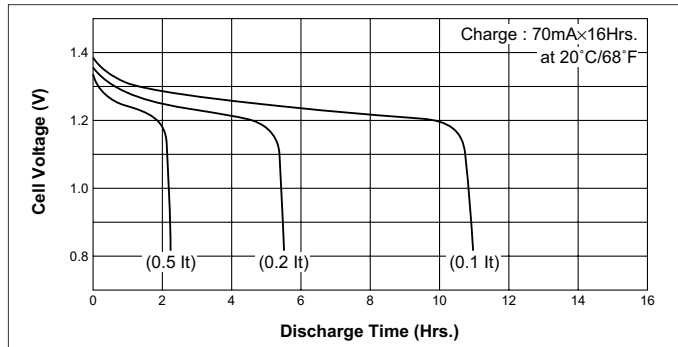

Temperature (Charge & Discharge)

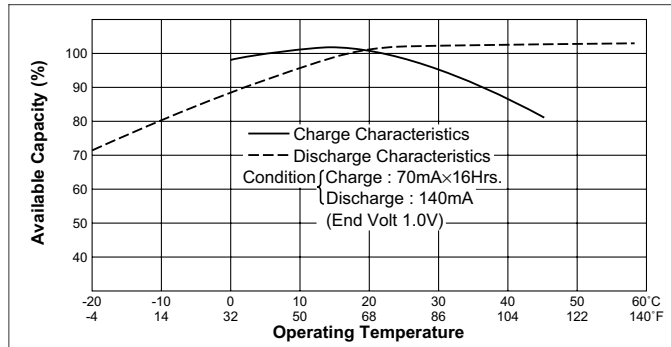

## X-ON Electronics

Largest Supplier of Electrical and Electronic Components

*Click to view similar products for [NiCd - Nickel Cadmium Battery](#) category:*

*Click to view products by [Panasonic](#) manufacturer:*

Other Similar products are found below :

[PS-850AA-T](#) [PS-D-T](#) [PS-F](#) [PS-C-T](#) [PS-CX-T](#) [PS-C](#) [PS-AAX](#) [PS-850AA](#) [PS-1/2D](#) [N-700AAC](#) [15568-1](#) [PS-2/3AA](#) [PS-AA](#) [PS-2/3A-T](#) [PS-A](#) [PS-SC](#) [PS-AAX-T](#) [PS-1/2D-T](#) [PS-2/3A](#) [PS-AAA](#) [PS-D](#)