

STRONGHOLD™

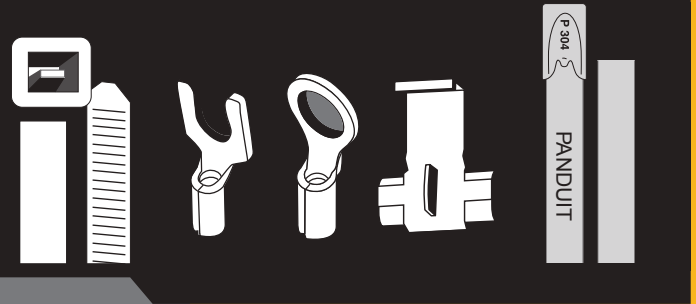
CONTRACTOR GRADE PRODUCTS
FOR GENERAL PURPOSE APPLICATIONS

STRONGHOLD™

CONTRACTOR GRADE PRODUCTS
FOR GENERAL PURPOSE APPLICATIONS

Panduit Corporate World Headquarters

Tinley Park, Illinois 60487



For more information

Visit us at www.panduit.com

Contact Customer Service by email: cs@panduit.com
or by phone: 800-777-3300

Commercial Construction Pocket Guide

© 2018 Panduit Corp.
ALL RIGHTS RESERVED
Printed in the U.S.A.
Catalog Number **CMCB02-SA-ENG**
Replaces WACB24-SA-ENG
9/2018

PANDUIT®

Contractor Grade Solutions for Electrical and Networking Installations

Panduit is committed to providing our contractor partners a comprehensive portfolio of products, programs, and services to help increase job site productivity, improve back-office operations, and accelerate cash flow. Our collaborative approach addresses the greatest business challenges for the contractor community, and provides a competitive advantage in your market space.

Solutions

- Whether the solution is for electrical or networking systems, Panduit offers a unique understanding of the complexities of infrastructure construction
- We continually offer new application systems focused on meeting the ever-changing installation and maintenance needs of our customers

Programs*

- The Panduit Business Partner Program offers a variety of benefits designed to help increase effectiveness, address the business needs of customers, and grow overall profitability
- A prescriptive planning and inventory management program that provides visibility throughout all levels of the supply chain to increase service levels and keep projects on schedule

Services

- The Mobile Access Guide immediately provides information required to keep your project moving when working on-site or from most any remote location
- Extensive website with product specifications, installation guides, part drawings and more, to make your job easier
- World-class customer service and product availability keep your projects on time and within budget

STRONGHOLD™

CONTRACTOR GRADE PRODUCTS
FOR GENERAL PURPOSE APPLICATIONS

*For complete program details, go to www.panduit.com or contact Customer Service at 800.777.3300. All programs and benefits subject to terms and conditions.

StrongHold™ Electrical/Network Supports and Fasteners

Panduit electrical/network supports and fasteners provide a reliable, high-quality solution for routing and securing power and communication cabling within commercial and industrial facilities.

StrongHold™ Supports and Fasteners are designed to meet the regulatory requirements of NFPA 70 (National Electric Code), UL standards, and other USA/Canadian building codes.



A. StrongHold™ Cable Ties	A.1 – A.6
B. StrongHold™ Stainless Steel Cable Ties	B.1 – B.8
C. StrongHold™ Terminals	C.1 – C.8
D. StrongHold™ Cable/Conduit	D.1 – D.19
E. StrongHold™ Beam/Purlin	E.1 – E.12
F. StrongHold™ Hangers/Hanging Systems	F.1 – F.2
G. StrongHold™ Stud Wall	G.1 – G.18
H. StrongHold™ Communication/Low Voltage	H.1 – H.16
I. StrongHold™ Dry Wall	I.1 – I.2
J. StrongHold™ Acoustical	J.1 – J.10
K. StrongHold™ Cabling System	K.1 – K.16
L. Miscellaneous	L.1 – L.4
M. Convenient Sizing Information	M.1 – M.8
N. Codes and Standards	N1 – N.20
O. Index	0.1 – 0.7

STRONGHOLD™

CONTRACTOR GRADE PRODUCTS
FOR GENERAL PURPOSE APPLICATIONS

STRONGHOLD™

Cable Ties

Panduit offers a comprehensive selection of cable tie solutions ideal for electrical, industrial, and networking applications. Panduit® Pan-Ty® Cable Ties are the premium grade offering, designed to accommodate a variety of industry requirements suitable for OEM and demanding MRO environments. For contractors seeking an economical solution to satisfy general purpose applications, the Panduit® StrongHold™ Cable Ties will meet this need with an assortment of indoor and outdoor cable ties.



StrongHold™ Contractor Grade Cable Ties



Application Environments

95+ Part Numbers

- Suitable for general purpose, light commercial, contractor, residential and HVAC applications
- No controlled tension during installation (not for use with cable tie installation tool)



Product Offering

Materials/Environment

- Nylon 6.6 in natural and in UV weather resistant black
 - Suitable for Premium spaces
 - Black UV suitable for outdoor use

Tie Construction (Cross-Sectional Area)

- Available in Miniature, Intermediate, Standard, Light Heavy, and Heavy
 - Loop tensile strength 18, 40, 50, 120 and 175 lbs.
 - Tie lengths 3.9" to 48.0"
 - Bundle diameters to 14.3"

Operating Temperature

- -40°C to 85°C



Compliance Ratings

cULus Listed to UL 62275 Type 2,21



Project Based Pricing

—



Application Support

—



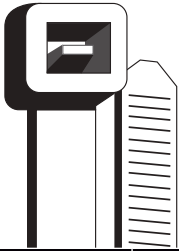
Pricing

Value Price Model



Standard Part Number		Bulk Part Number		Length (in.)	
Natural Nylon 6.6 (Indoor Use)	UV Weather Resistant Nylon 6.6 (Outdoor Use)	Natural Nylon 6.6 (Indoor Use)	UV Weather Resistant Nylon 6.6 (Outdoor Use)		
Cable Ties, 18 lbs					
S4-18-C	S4-18-C0	S4-18-M	S4-18-M0	3.94	
S6-18-C	S6-18-C0	S6-18-M	S6-18-M0	6.30	
S8-18-C	S8-18-C0	S8-18-M	S8-18-M0	7.87	
Cable Ties, 40 lbs					
S6-40-C	S6-40-C0	S6-40-M	S6-40-M0	5.51	
S8-40-C	S8-40-C0	S8-40-M	S8-40-M0	7.87	
S12-40-C	S12-40-C0	S12-40-M	S12-40-M0	11.81	
S15-40-C	S15-40-C0	-	-	14.57	
Cable Ties, 50 lbs					
S5-50-C	S5-50-C0	S5-50-M	S5-50-M0	4.72	
S6-50-C	S6-50-C0	S6-50-M	S6-50-M0	6.30	
S7-50-C	S7-50-C0	S7-50-M	S7-50-M0	7.40	
S8-50-C	S8-50-C0	S8-50-M	S8-50-M0	8.46	
S10-50-C	S10-50-C0	-	-	9.84	
S12-50-C	S12-50-C0	S12-50-M	S12-50-M0	11.81	
S15-50-C	S15-50-C0	S15-50-M	S15-50-M0	14.57	
S17-50-C	S17-50-C0	S17-50-M	S17-50-M0	16.9	
S21-50-C	S21-50-C0	S21-50-M	S21-50-M0	20.87	

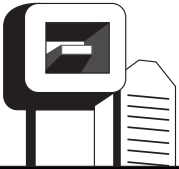
StrongHold™ Cable Tie Part Numbers



	Max. Bundle Diameter (in.)	Width (in.)	Min. Loop Tensile Strength (Lbs)	Std. Pkg. Qty	Blk. Pkg. Qty
Cable Ties, 18 lbs					
	0.87	0.10	18	100	1000
	1.57	0.10	18	100	1000
	2.09	0.10	18	100	1000
Cable Ties, 40 lbs					
	1.30	0.14	40	100	1000
	2.09	0.14	40	100	1000
	2.99	0.14	40	100	1000
	4.02	0.14	40	100	-
Cable Ties, 50 lbs					
	0.94	0.19	50	100	1000
	1.50	0.19	50	100	1000
	1.81	0.19	50	100	1000
	2.09	0.19	50	100	1000
	1.97	0.19	50	100	-
	2.99	0.19	50	100	1000
	4.02	0.19	50	100	1000
	4.33	0.19	50	100	1000
	5.51	0.19	50	100	1000

* UL Recognized. **UL 181. ° Mount with #10/M5 Screw. °° Mount with ¼"/M6 Screw.

ˆ Plenum Rated AH-2. ^ Gray Nylon Available S-48-175-L8

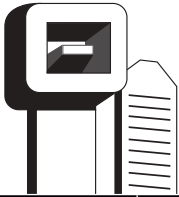


Standard Part Number		Bulk Part Number		Length (In.)	
Natural Nylon 6.6 (Indoor Use)	UV Weather Resistant Nylon 6.6 (Outdoor Use)	Natural Nylon 6.6 (Indoor Use)	UV Weather Resistant Nylon 6.6 (Outdoor Use)		
Cable Ties, Releasable, 50 lbs					
SC8-50-S10-C	SC8-50-S10-C0	-	-	7.87	
Cable Ties, Clamp Style, 50 lbs					
SC8-50-S10-C	SC8-50-S10-C0	-	-	7.87	
Cable Ties, 120 lbs					
S14-120-L	S14-120-L0	S14-120-TL	S14-120-TL0	14.49	
S18-120-L	S18-120-L0	-	-	17.71	
S21-120-L	S21-120-L0	S21-120-C	S21-120-C0	20.98	
S24-120-Q	S24-120-Q0	S24-120-L	S24-120-L0	23.62	
S30-120-X	S30-120-X0	S30-120-L	S30-120-L0	29.53	
Cable Ties, Clamp Style, 120 lbs					
SC15-120-S25-L	SC15-120-S25-L0	-	-	14.96	
Cable Ties, Clamp Style, 175 lbs					
S30-120-X	S30-120-X0	S30-120-L	S30-120-L0	29.53	
S30-120-X	S30-120-X0	S30-120-L	S30-120-L0	29.53	
S30-120-X	S30-120-X0	S30-120-L	S30-120-L0	29.53	
S30-120-X	S30-120-X0	S30-120-L	S30-120-L0	29.53	
S30-120-X	S30-120-X0	S30-120-L	S30-120-L0	29.53	
S30-120-X	S30-120-X0	S30-120-L	S30-120-L0	29.53	
S30-120-X	S30-120-X0	S30-120-L	S30-120-L0	29.53	
S30-120-X	S30-120-X0	S30-120-L	S30-120-L0	29.53	
S30-120-X	S30-120-X0	S30-120-L	S30-120-L0	29.53	

* UL Recognized. **UL 181. ° Mount with #10/M5 Screw. °° Mount with ¼"/M6 Screw.

* Plenum Rated AH-2. ^ Gray Nylon Available S-48-175-L8

StrongHold™ Cable Tie Part Numbers



	Max. Bundle Diameter (In.)	Width (in.)	Min. Loop Tensile Strength (Lbs)	Std. Pkg. Qty	Blk. Pkg. Qty
Cable Ties, Releasable, 50 lbs					
	1.97	0.19	50	100	-
Cable Ties, Clamp Style, 50 lbs					
	1.97	0.19	50	100	-
Cable Ties, 120 lbs					
	4.02	0.30	120	50	250
	5.20	0.30	120	50	-
	5.51	0.30	120	50	100
	6.69	0.30	120	25	50
	8.58	0.30	120	10	50
Cable Ties, Clamp Style, 120 lbs					
	3.86	0.30	120	50	-
Cable Ties, Clamp Style, 175 lbs					
	8.58	0.30	120	10	50
	8.58	0.30	120	10	50
	8.58	0.30	120	10	50
	8.58	0.30	120	10	50
	8.58	0.30	120	10	50
	8.58	0.30	120	10	50
	8.58	0.30	120	10	50
	8.58	0.30	120	10	50
	8.58	0.30	120	10	50

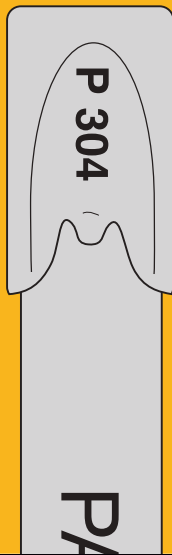
* UL Recognized. **UL 181. ° Mount with #10/M5 Screw. °° Mount with ¼"/M6 Screw.

ˆ Plenum Rated AH-2. ^ Gray Nylon Available S-48-175-L8

STRONGHOLD™

Stainless Steel Cable Ties

Panduit offers a comprehensive offering of Stainless Steel Cable Ties including Self-Locking, Fully Coated, Metal Strapping and buckles.



PANDUIT

StrongHold™ Stainless Steel Cable Ties



Application Environments

66+ Part Numbers

Suitable for the following verticals:

- Chemical Plants and Refineries
- Industrial Construction
- Mining
- Oil and Gas
- MRO
- Shipbuilding
- General Applications requiring Cable Management



Product Offering

Materials/Environment

IMLTs:

Available in AISI 304 stainless steel for general purpose applications and AISI 316L stainless steel for the most corrosive environments

MLTFCs:

Epoxy polyester coating available in black only

Made in China with non-DFARS Steel

Tie Construction (Cross-Sectional Area)

Available in standard and heavy

Loop Tensile Strength:

100 to 200 Lbs. (445 to 890N)



Product Availability

Available on request 8-10 week lead time



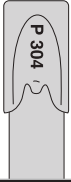
Application Support

—



Pricing

Value Price Model

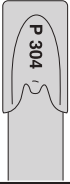


Part Number	Material	Max Bundle Diameter (mm)	Min Bundle Diameter (mm)	Min Loop Tensile Strength (N)	Length (mm)*	Width (mm)
StrongHold™ Self-Locking Cable Ties						
IMLT25S-C	304	25	12.7	556	127	4.6
IMLT51S-C	304	51	12.7	556	201	4.6
IMLT69S-C	304	69	12.7	556	259	4.6
IMLT102S-C	304	102	12.7	556	362	4.6
IMLT152S-C	304	152	12.7	556	521	4.6
IMLT203S-C	304	203	12.7	556	679	4.6
IMLT254S-C	304	254	12.7	556	838	4.6
IMLT304S-Q	304	304	12.7	556	998	4.6
IMLT355S-Q	304	355	12.7	556	1156	4.6
IMLT380S-Q	304	380	12.7	556	1250	4.6
IMLT25S-C6L	316L	25	12.7	556	127	4.6
IMLT51S-C6L	316L	51	12.7	556	201	4.6
IMLT69S-C6L	316L	69	12.7	556	259	4.6
IMLT102S-C6L	316L	102	12.7	556	362	4.6
IMLT152S-C6L	316L	152	12.7	556	521	4.6
IMLT203S-C6L	316L	203	12.7	556	679	4.6
IMLT254S-C6L	316L	254	12.7	556	838	4.6
IMLT304S-Q6L	316L	304	12.7	556	998	4.6
IMLT355S-Q6L	316L	355	12.7	556	1156	4.6
IMLT380S-Q6L	316L	380	12.7	556	1250	4.6
IMLT51H-L	304	51	12.7	890	201	7.9
IMLT69H-L	304	69	12.7	890	259	7.9
IMLT102H-L	304	102	12.7	890	362	7.9
IMLT152H-L	304	152	12.7	890	521	7.9
IMLT203H-L	304	203	12.7	890	679	7.9
IMLT254H-L	304	254	12.7	890	838	7.9
IMLT304H-Q	304	304	12.7	890	998	7.9
IMLT355H-Q	304	355	12.7	890	1156	7.9
IMLT51H-L6L	316L	51	12.7	890	201	7.9
IMLT69H-L6L	316L	69	12.7	890	259	7.9
IMLT102H-L6L	316L	102	12.7	890	362	7.9
IMLT152H-L6L	316L	152	12.7	890	521	7.9
IMLT203H-L6L	316L	203	12.7	890	679	7.9
IMLT254H-L6L	316L	254	12.7	890	838	7.9
IMLT304H-Q6L	316L	304	12.7	890	998	7.9
IMLT355H-Q6L	316L	355	12.7	890	1156	7.9

StrongHold™ Stainless Steel Cable Tie Part Numbers



Thickness (mm)	Recommended Tool	Std Pkg Qty	Std Ctn Qty
StrongHold™ Self-Locking Cable Ties			
0.25	GS4MT-E, HTMT, PPTMT, ST2MT	100	500
0.25	GS4MT-E, HTMT, PPTMT, ST2MT	100	500
0.25	GS4MT-E, HTMT, PPTMT, ST2MT	100	500
0.25	GS4MT-E, HTMT, PPTMT, ST2MT	100	500
0.25	GS4MT-E, HTMT, PPTMT, ST2MT	100	500
0.25	GS4MT-E, HTMT, PPTMT, ST2MT	100	500
0.25	GS4MT-E, HTMT, PPTMT, ST2MT	25	125
0.25	GS4MT-E, HTMT, PPTMT, ST2MT	25	125
0.25	GS4MT-E, HTMT, PPTMT, ST2MT	25	125
0.25	GS4MT-E, HTMT, PPTMT, ST2MT	100	500
0.25	GS4MT-E, HTMT, PPTMT, ST2MT	100	500
0.25	GS4MT-E, HTMT, PPTMT, ST2MT	100	500
0.25	GS4MT-E, HTMT, PPTMT, ST2MT	100	500
0.25	GS4MT-E, HTMT, PPTMT, ST2MT	100	500
0.25	GS4MT-E, HTMT, PPTMT, ST2MT	100	500
0.25	GS4MT-E, HTMT, PPTMT, ST2MT	100	500
0.25	GS4MT-E, HTMT, PPTMT, ST2MT	25	125
0.25	GS4MT-E, HTMT, PPTMT, ST2MT	25	125
0.25	GS4MT-E, HTMT, PPTMT, ST2MT, PBTMT	50	250
0.25	GS4MT-E, HTMT, PPTMT, ST2MT, PBTMT	50	250
0.25	GS4MT-E, HTMT, PPTMT, ST2MT, PBTMT	50	250
0.25	GS4MT-E, HTMT, PPTMT, ST2MT, PBTMT	50	250
0.25	GS4MT-E, HTMT, PPTMT, ST2MT, PBTMT	50	250
0.25	GS4MT-E, HTMT, PPTMT, ST2MT, PBTMT	50	250
0.25	GS4MT-E, HTMT, PPTMT, ST2MT, PBTMT	25	125
0.25	GS4MT-E, HTMT, PPTMT, ST2MT, PBTMT	25	125
0.25	GS4MT-E, HTMT, PPTMT, ST2MT, PBTMT	50	250
0.25	GS4MT-E, HTMT, PPTMT, ST2MT, PBTMT	50	250
0.25	GS4MT-E, HTMT, PPTMT, ST2MT, PBTMT	50	250
0.25	GS4MT-E, HTMT, PPTMT, ST2MT, PBTMT	50	250
0.25	GS4MT-E, HTMT, PPTMT, ST2MT, PBTMT	50	250
0.25	GS4MT-E, HTMT, PPTMT, ST2MT, PBTMT	50	250
0.25	GS4MT-E, HTMT, PPTMT, ST2MT, PBTMT	25	125
0.25	GS4MT-E, HTMT, PPTMT, ST2MT, PBTMT	25	125

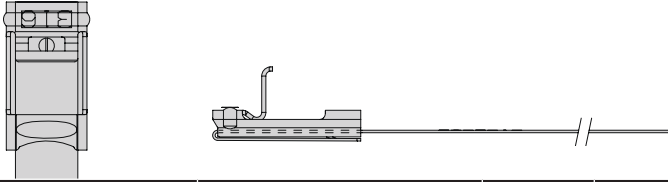


Part Number	Material	Max Bundle Diameter (mm)	Min Bundle Diameter (mm)	Min Loop Tensile Strength (N)	Length (mm)	Width (mm)
StrongHold™ Self-Locking Fully Coated Cable Ties						
IMLTFC38S-C6L	316L	38	12.7	445	158	4.6
IMLTFC51S-C6L	316L	51	12.7	445	201	4.6
IMLTFC64S-C6L	316L	64	12.7	445	233	4.6
IMLTFC86S-C6L	316L	86	12.7	445	310	4.6
IMLTFC102S-C6L	316L	102	12.7	445	362	4.6
IMLTFC137S-C6L	316L	137	12.7	445	462	4.6
IMLTFC152S-C6L	316L	152	12.7	445	521	4.6
IMLTFC203S-C6L	316L	203	12.7	445	679	4.6
IMLTFC38H-C6L	316L	38	12.7	890	158	7.9
IMLTFC51H-L6L	316L	51	12.7	890	201	7.9
IMLTFC64H-C6L	316L	64	12.7	890	233	7.9
IMLTFC69H-L6L	316L	69	12.7	890	259	7.9
IMLTFC86H-C6L	316L	86	12.7	890	310	7.9
IMLTFC102H-L6L	316L	102	12.7	890	362	7.9
IMLTFC137H-C6L	316L	137	12.7	890	462	7.9
IMLTFC152H-L6L	316L	152	12.7	890	521	7.9
IMLTFC203H-L6L	316L	203	12.7	890	679	7.9

StrongHold™ Stainless Steel Cable Tie Part Numbers



Thickness (mm)	Recommended Tool	Std Pkg Qty	Std Ctn Qty
StrongHold™ Self-Locking Fully Coated Cable Ties			
0.25	GS4MT-E, HTMT, PPTMT, ST2MT	100	500
0.25	GS4MT-E, HTMT, PPTMT, ST2MT	100	500
0.25	GS4MT-E, HTMT, PPTMT, ST2MT	100	500
0.25	GS4MT-E, HTMT, PPTMT, ST2MT	100	500
0.25	GS4MT-E, HTMT, PPTMT, ST2MT	100	500
0.25	GS4MT-E, HTMT, PPTMT, ST2MT	100	500
0.25	GS4MT-E, HTMT, PPTMT, ST2MT	100	500
0.25	GS4MT-E, HTMT, PPTMT, ST2MT	100	500
0.25	GS4MT-E, HTMT, PPTMT, ST2MT, PBTMT	100	500
0.25	GS4MT-E, HTMT, PPTMT, ST2MT, PBTMT	50	250
0.25	GS4MT-E, HTMT, PPTMT, ST2MT, PBTMT	100	500
0.25	GS4MT-E, HTMT, PPTMT, ST2MT, PBTMT	50	250
0.25	GS4MT-E, HTMT, PPTMT, ST2MT, PBTMT	100	500
0.25	GS4MT-E, HTMT, PPTMT, ST2MT, PBTMT	50	250
0.25	GS4MT-E, HTMT, PPTMT, ST2MT, PBTMT	100	500
0.25	GS4MT-E, HTMT, PPTMT, ST2MT, PBTMT	50	250
0.25	GS4MT-E, HTMT, PPTMT, ST2MT, PBTMT	50	250

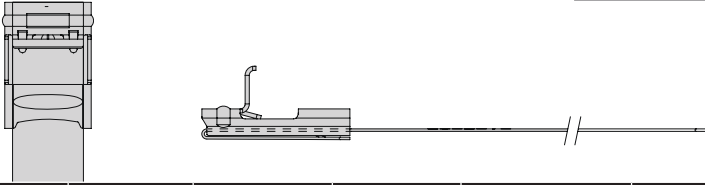


Part Number	Material	Length	Strap Breaking Strength
		M	N
StrongHold™ Metal Strapping (Uncoated) - Coil			
IMS9.5T35-QR6L	Stainless Steel Type 316L	25	1780
IMS12T35-QR6L	Stainless Steel Type 316L	25	2445
IMS16T35-QR6L	Stainless Steel Type 316L	25	3110
IMS19T75-QR6L	Stainless Steel Type 316L	25	4225
StrongHold™ Metal Strapping (Coated with Epoxy Polyester) - Coil			
IMSP9.5T35-QR6L	Stainless Steel Type 316L	25	1780
IMSP12T35-QR6L	Stainless Steel Type 316L	25	2445
IMSP16T35-QR6L	Stainless Steel Type 316L	25	3110

^Base material less coating

Part Number	Material	Width
		mm
StrongHold™ Buckles		
IMSBL9.5-C6L	Stainless Steel Type 316L	9.5
IMSBL12-C6L	Stainless Steel Type 316L	12
IMSBL16-C6L	Stainless Steel Type 316L	16
IMSBE19-C6L	Stainless Steel Type 316L	19

StrongHold™ Stainless Steel Straps and Buckles Part Numbers














	Min Bundle Diameter mm	Width mm	Thickness mm	Recommended Installation Tool	Std. Pkg. Qty.
StrongHold™ Metal Strapping (Uncoated) - Coil					
	26	9.5	0.35	BT75SDT	1
	26	12	0.35	BT75SDT	1
	26	16	0.35	BT75SDT	1
	26	19	0.75	BT75SDT	1
StrongHold™ Metal Strapping (Coated with Epoxy Polyester) - Coil					
	26	9.5	0.35^	BT75SDT	1
	26	12	0.35^	BT75SDT	1
	26	16	0.35^	BT75SDT	1

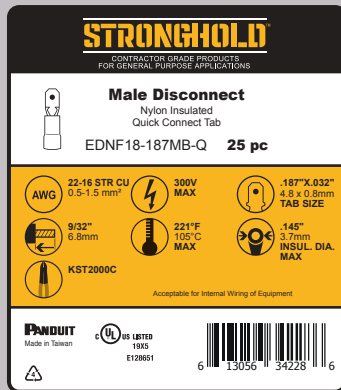
Part Description	Std. Pkg. Qty.
StrongHold™ Buckles	
Individual Buckle Style L for use with 9.5 mm strapping	100
Individual Buckle Style L for use with 12 mm strapping	100
Individual Buckle Style L for use with 16 mm strapping	100
Individual Buckle Style E for use with 19 mm strapping	100

STRONGHOLD™ Terminals

As a trusted brand, Panduit provides solutions that will stay strong for a wide range of general purpose applications and outlast the competition. For contractors seeking an economical solution to satisfy general purpose applications, look no further than the StrongHold™ (Contractor Grade) Terminals Line.

Navigating the StrongHold Packaging Icons

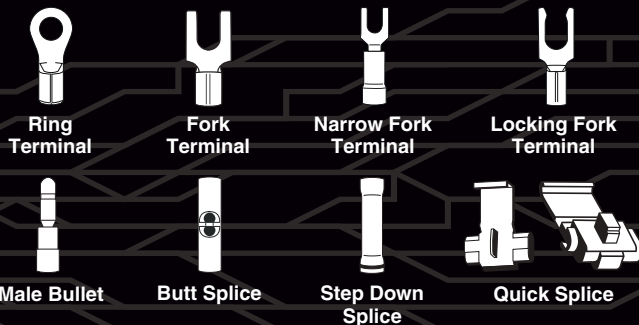
-  American Wire Gauge
-  Circular Mil
-  Insulation Diagram
-  Max Temperature
-  PIN Diagram
-  Strip Length
-  Voltage
-  Stud Size
-  Tab Size
-  Tool
-  Bullet



Please note the following information regarding bag quantities:
 * -Q= Package quantity of 25
 -L= Package quantity of 50 where applicable
 See Panduit.com for individual part compliance and tooling options. All parts are ROHS compliant.


Terminals Legend

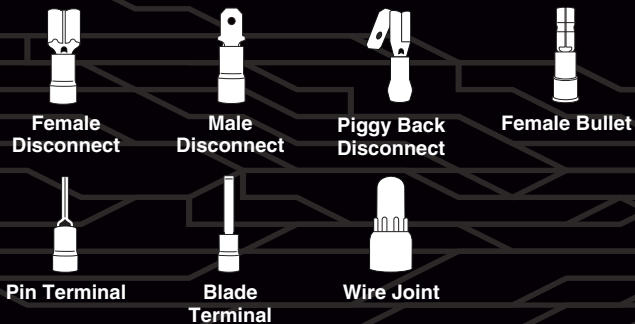
Available in insulated and non-insulated options. See insulation options throughout this booklet for detailed information per product.






StrongHold™ Terminal Part Numbers

Ring Terminal





Part Number	Wire Range (AWG)	Color	Stud/Tab Size	Std. Pkg. Qty.
Ring Terminal, Insulated – Vinyl				
 EV6-10R-Q	#6	Blue	#10	25
EV6-12R-Q	#6	Blue	1/2"	25
EV6-38R-Q	#6	Blue	3/8"	25
EV6-56R-Q	#6	Blue	5/16"	25
EV8-8R-Q	#8	Red	#8	25
EV8-12R-Q	#8	Red	1/2"	25
EV8-14R-Q	#8	Red	1/4"	25
EV8-38R-Q	#8	Red	3/8"	25
EV8-56R-Q	#8	Yellow	5/16"	25
EV10-10RB-Q	#12-10	Yellow	#10	25
EV10-12RB-Q	#12-10	Yellow	1/2"	25
EV10-14RB-Q	#12-10	Yellow	1/4"	25
EV10-38RB-Q	#12-10	Yellow	3/8"	25
EV10-56RB-Q	#12-10	Yellow	5/16"	25
EV10-6RB-Q	#12-10	Yellow	#6	25
EV10-8RB-Q	#12-10	Yellow	#8	25
EV14-10RB-Q*	#16-14	Blue	#10	25
EV14-14RB-Q*	#16-14	Blue	1/4"	25
EV14-38RB-Q	#16-14	Blue	3/8"	25
EV14-56RB-Q*	#16-14	Blue	5/16"	25
EV14-6RB-Q*	#16-14	Blue	#6	25
EV14-8RB-Q*	#16-14	Blue	#8	25
EV18-8RB-Q*	#22-18	Red	#8	25
EV18-10RB-Q*	#22-18	Red	#10	25
EV18-14RB-Q*	#22-18	Red	1/4"	25
EV18-56RB-Q*	#22-18	Red	5/16"	25
EV18-6RB-Q*	#22-18	Red	#6	25



Ring Terminal


Part Number	 Wire Range (AWG)	Color	 Stud/Tab Size	Std. Pkg. Qty.	
Ring Terminal, Non-Insulated					
	E10-10RB-Q	#12-10	Yellow	#10	25
	E10-14RB-Q	#12-10	Yellow	1/4"	25
	E10-6RB-Q	#12-10	Yellow	#6	25
	E10-8RB-Q	#12-10	Yellow	#8	25
	E14-10RB-Q*	#16-14	Blue	#10	25
	E14-4RB-Q*	#16-14	Blue	#4	25
	E14-6RB-Q*	#16-14	Blue	#6	25
	E14-8RB-Q*	#16-14	Blue	#8	25
	E18-10RB-Q*	#22-18	Red	#10	25
	E18-4RB-Q*	#22-18	Red	#4	25
	E18-6RB-Q*	#22-18	Red	#6	25
	E18-8RB-Q*	#22-18	Red	#8	25

Fork Terminal



Part Number	 Wire Range (AWG)	Color	 Stud/Tab Size	Std. Pkg. Qty.	
Fork Terminal, Insulated – Vinyl					
	EV10-10FB-Q	#12-10	Yellow	#10	25
	EV10-14FB-Q	#12-10	Yellow	1/4"	25
	EV10-56FB-Q	#12-10	Yellow	5/16"	25
	EV10-6FB-Q	#12-10	Yellow	#6	25
	EV10-8FB-Q	#12-10	Yellow	#8	25
	EV14-10FB-Q*	#16-14	Blue	#10	25
	EV14-14FB-Q	#16-14	Blue	1/4"	25
	EV14-6FB-Q*	#16-14	Blue	#6	25
	EV14-8FB-Q*	#16-14	Blue	#8	25
	EV18-10FB-Q*	#22-18	Red	#10	25
	EV18-6FB-Q*	#22-18	Red	#6	25
	EV18-8FB-Q*	#22-18	Red	#8	25
EV18-14FB-Q	#22-16	Red	1/4"	25	
Fork Terminal, Non-Insulated					
	E10-10FB-Q	#12-10	Yellow	#10	25
	E10-14FB-Q	#12-10	Yellow	1/4"	25
	E10-6FB-Q	#12-10	Yellow	#6	25
	E10-8FB-Q	#12-10	Yellow	#8	25
	E14-10FB-Q*	#16-14	Blue	#10	25
	E14-6FB-Q*	#16-14	Blue	#6	25
	E14-8FB-Q*	#16-14	Blue	#8	25
	E18-10FB-Q*	#22-18	Red	#10	25
	E18-6FB-Q*	#22-18	Red	#6	25
	E18-8FB-Q*	#22-18	Red	#8	25

StrongHold™ Terminals Part Numbers


Narrow Fork Terminal

Part Number	AWG Wire Range (AWG)	Color	Stud/Tab Size	Std. Pkg. Qty.
Narrow Fork Terminal, Insulated – Vinyl				
 EV10-10FNB-Q	#12-10	Yellow	#10	25
EV10-8FNB-Q	#12-10	Yellow	#8	25
EV14-10FNB-Q	#16-14	Blue	#10	25
EV14-6FNB-Q	#16-14	Blue	#6	25
EV14-8FNB-Q	#16-14	Blue	#8	25



Locking Fork Terminal

Part Number	AWG Wire Range (AWG)	Color	Stud/Tab Size	Std. Pkg. Qty.
Locking Fork Terminal, Insulated – Vinyl				
 EV10-10LFB-Q	#12-10	Yellow	#10	25
EV10-14LFB-Q	#12-10	Yellow	1/4"	25
EV10-6LFB-Q	#12-10	Yellow	#6	25
EV10-8LFB-Q	#12-10	Yellow	#8	25
EV14-10LFB-Q*	#16-14	Blue	#10	25
EV14-6LFB-Q*	#16-14	Blue	#6	25
EV14-8LFB-Q*	#16-14	Blue	#8	25
EV18-10LFB-Q*	#22-18	Red	#10	25
EV18-6LFB-Q*	#22-18	Red	#6	25
EV18-8LFB-Q*	#22-18	Red	#8	25
Locking Fork Terminal, Non-Insulated				
 E10-10LFB-Q	#12-10	Yellow	#10	25
E10-14LFB-Q	#12-10	Yellow	1/4"	25
E10-6LFB-Q	#12-10	Yellow	#6	25
E10-8LFB-Q	#12-10	Yellow	#8	25
E14-10LFB-Q*	#16-14	Blue	#10	25
E14-6LFB-Q*	#16-14	Blue	#6	25
E14-8LFB-Q*	#16-14	Blue	#8	25
E18-10LFB-Q*	#22-18	Red	#10	25
E18-6LFB-Q*	#22-18	Red	#6	25
E18-8LFB-Q*	#22-18	Red	#8	25




Female Disconnect Terminal

Part Number	AWG Wire Range (AWG)	Color	Stud/Tab Size	Std. Pkg. Qty.
Female Disconnect Terminal, Insulated – Nylon				
 EDNF10-250FI-Q	#12-10	Yellow	0.250" x 0.032"	25
EDNF14-188FIB-Q*	#16-14	Blue	0.187" x 0.020"	25
EDNF14-250FIB-Q*	#16-14	Blue	0.250" x 0.032"	25
EDNF18-188FIB-Q*	#22-18	Red	0.187" x 0.020"	25
EDNF18-250FIB-Q*	#22-18	Red	0.250" x 0.032"	25

Female Disconnect Terminal


Part Number	AWG Wire Range (AWG)	Color	Stud/Tab Size	Std. Pkg. Qty.	
Female Disconnect Terminal, Insulated – Vinyl					
	EDV10-250-Q	#12-10	Yellow	0.250" x 0.032"	25
	EDV14-188B-Q*	#16-14	Blue	0.187" x 0.020"	25
	EDV14-250B-Q*	#16-14	Blue	0.250" x 0.032"	25
	EDV18-188B-Q*	#22-18	Red	0.187" x 0.020"	25
	EDV18-250B-Q*	#22-18	Red	0.250" x 0.032"	25
	EDV10-250FIB-Q	#12-10	Yellow	0.250" x 0.032"	25
	EDV14-250FIB-Q	#16-14	Blue	0.250" x 0.032"	25
	EDV18-250FIB-Q	#22-16	Red	0.250" x 0.032"	25
Female Disconnect Terminal, Non-Insulated					
	ED14-188-Q*	#16-14	Blue	0.187" x 0.020"	25
	ED14-250-Q*	#16-14	Blue	0.250" x 0.032"	25
	ED18-188-Q*	#22-18	Red	0.187" x 0.020"	25
	ED18-250-Q*	#22-18	Red	0.250" x 0.032"	25

Male Disconnect Terminal



Part Number	AWG Wire Range (AWG)	Color	Stud/Tab Size	Std. Pkg. Qty.	
Male Disconnect Terminal, Insulated – Nylon					
	EDNF14-187MB-Q	#16-14	Blue	0.187" x 0.032"	25
	EDNF18-187MB-Q	#22-16	Red	0.187" x 0.032"	25
	EDNF10250FIMB-Q	#12-10	Yellow	0.250" x 0.032"	25
	EDNF14250FIMB-Q*	#16-14	Blue	0.250" x 0.032"	25
	EDNF18250FIMB-Q*	#22-18	Red	0.250" x 0.032"	25
Male Disconnect Terminal, Insulated – Vinyl					
	EDV10-250M-Q	#12-10	Yellow	0.250" x 0.032"	25
	EDV14-187MB-Q	#16-14	Blue	0.187" x 0.032"	25
	EDV14-250M-Q*	#16-14	Blue	0.250" x 0.032"	25
	EDV18-187MB-Q	#22-16	Red	0.187" x 0.032"	25
	EDV18-250M-Q*	#22-18	Red	0.250" x 0.032"	25
Male Disconnect Terminal, Non-Insulated					
	ED10-250M-Q	#12-10	Yellow	0.250" x 0.032"	25
	ED14-250MB-Q*	#16-14	Blue	0.250" x 0.032"	25
	ED18-250MB-Q*	#22-18	Red	0.250" x 0.032"	25

StrongHold™ Terminals Part Numbers



Piggy Back Disconnect Terminal

Part Number	AWG Wire Range (AWG)	Color	Stud/Tab Size	Std. Pkg. Qty.
 Piggy Back Disconnect Terminal, Insulated – Vinyl				
EDV10-250P-Q	#12-10	Yellow	0.250" x 0.032"	25
EDV14-250P-Q*	#16-14	Blue	0.250" x 0.032"	25
EDV18-250P-Q*	#22-18	Red	0.250" x 0.032"	25



Female Bullet Terminal

Part Number	AWG Wire Range (AWG)	Color	Bullet	Std. Pkg. Qty.
 Female Bullet Terminal, Insulated – Nylon				
EBNF14-4FIB-Q	#16-14	Blue	.156" / 3.9mm	25
EBNF18-4FIB-Q	#22-16	Red	.156" / 3.9mm	25
 Female Bullet Terminal, Insulated – Vinyl				
EBV18-4B-Q	#22-16	Red	.156" / 3.9mm	25
EBV14-4B-Q	#16-14	Blue	.156" / 3.9mm	25



Male Bullet Terminal

Part Number	AWG Wire Range (AWG)	Color	Bullet	Std. Pkg. Qty.
 Male Bullet Terminal, Insulated – Nylon				
EBNF14-4FIM-Q	#16-14	Blue	.156" / 3.9mm	25
EBNF18-4FIM-Q	#22-16	Red	.156" / 3.9mm	25
 Male Bullet Terminal, Insulated – Vinyl				
EBV14-4MB-Q	#16-14	Blue	.156" / 3.9mm	25
EBV18-4MB-Q	#22-16	Red	.156" / 3.9mm	25



Butt Splice

Part Number	AWG Wire Range (AWG)	Color	Std. Pkg. Qty.
 Butt Splice, Insulated – Vinyl			
ESV10BX-Q	#12-10	Yellow	25
ESV14BX-Q*	#16-14	Blue	25
ESV18BX-Q*	#22-18	Red	25
 Butt Splice, Non-Insulated			
ES10B-Q	#12-10	Yellow	25
ES14B-Q*	#16-14	Blue	25
ES18B-Q*	#22-18	Red	25




Step Down Splice

Part Number	 Wire Range (AWG)	Color	Std. Pkg. Qty.	
Step Down Splice, Insulated – Vinyl				
	ESV10-ESV14-Q	#12-10 to 16-14, Yellow with Blue Color Ring	Yellow	25
	ESV10-ESV18-Q	#12-10 to 22-18, Yellow with Red Color Ring	Yellow	25
	ESV14-ESV18-Q	#16-14 to 22-18, Blue with Red Color Ring	Blue	25
	ESV6-ESV8-Q	#6 to 8, Blue with Red Color Ring	Blue	25
	ESV8-ESV10-Q	#8 to 12-10, Red with Yellow Color Ring	Red	25
	ESV8-ESV14-Q	#8 to 16-14, Red with Blue Color Ring	Red	25

Quick Splice


Part Number	 Wire Range (AWG)	Color	Std. Pkg. Qty.	
Quick Splice, Insulated – Polypropylene				
	EQSP18D-Q	#22-16	Red	25
	EQSP14D-Q*	#18-14	Blue	25
	EQSP10-18D-Q	#12-10 to 18-14	Brown	25
	EQSP10-Q	#12-10	Yellow	25
	EQSP14-Q	#18-14	Blue	25
	EQSP18-Q	#22-18	Red	25

Pin Terminal


Part Number	 Wire Range (AWG)	Color	 Pin Diameter	Std. Pkg. Qty.	
Pin Terminal, Insulated – Vinyl					
	EV10-P55-Q	#12-10	Yellow	0.10" Dia.	25
	EV14-P47B-Q*	#16-14	Blue	0.07" Dia.	25
	EV18-P47B-Q*	#22-18	Red	0.07" Dia.	25

StrongHold™ Terminals Part Numbers

Blade Terminal

	Part Number	AWG Wire Range (AWG)	Color	Std. Pkg. Qty.
	Blade Terminal, Insulated – Vinyl			
	EDV10-11MB-Q	#12-10	Yellow	25
	EDV14-87MB-Q	#16-14	Blue	25
	EDV18-87MB-Q	#22-18	Red	25

Wire Joint

	Part Number	AWG Wire Range (AWG)	Color	Std. Pkg. Qty.
	Wire Joint, Insulated – Nylon			
	EJN218-216-Q*	#22-14	Clear	25
	EJN418-212-Q	#18 -12	Clear	25
	EJN314-412-Q	#16-8	Clear	25

Please note the following information regarding bag quantities:

*-Q= Package quantity of 25

-L= Package quantity of 50 where applicable

See Panduit.com for individual part compliance and tooling options.

All parts are ROHS compliant.

Snap-Close Conduit Clips



Image 1



Image 2

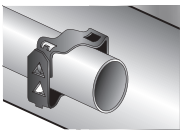
- No fastener required to retain conduit
- Static load capacity:
 - 100 lbs. in vertical position
 - 25 lbs. in horizontal position



Part Number	Image No.	Fits EMT/ Rigid/IMC (In.)	Mounting Hole (In.)	Std. Pkg. Qty.
P6M	1	3/8*	1/4 non-threaded	100
P16M	1	1		100
P20M	1	1 1/4		100
P24M	1	1 1/2		100
P812M	1	1/2 – 3/4		100
P812M4I**	2	1/2 – 3/4	1/4-20 threaded	100
P32M	1	2	1/4 non-threaded	100

*Or 14-2 through 12-3 MC/AC cable.

**Not UL or cUL listed.



Push-Fit Conduit Clips



- No fastener required to retain conduit
- Static load capacity:
 - 25 lbs. in vertical position
 - 15 lbs. in horizontal position
- Available with 1/4" non-threaded mounting hole

Part Number	Fits EMT (In.)	Fits Rigid/IMC (In.)	Std. Pkg. Qty.
P8P	1/2	—	100
P12P	3/4	1/2	100
P16P	1	3/4	100

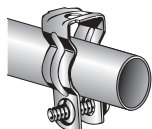
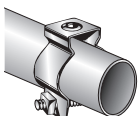


Conduit Clamps with Bolt


- Conduit hanger available for 1/2" – 4" conduit
- Bolt and nut (Phillips/flathead) provide positive securing feature
- Available with threaded and non-threaded mounting hole



Part Number	Fits EMT (In.)	Fits Rigid/IMC (In.)	Mounting Hole (In.)	Std. Pkg. Qty.
PCD0B	1/2	3/8 – 1/2	1/4 non-threaded	100
PCD1B	3/4	3/4	1/4 non-threaded	100
PCD2B	1	1	1/4 non-threaded	100
PCD2.5B	1 1/4	—	1/4 non-threaded	100
PCD3B	1 1/2	1 1/4	1/4 non-threaded	100
PCD4B	—	1 1/2	5/16 non-threaded	100
PCD5B	2	2	5/16 non-threaded	50
PCD6B	2 1/2	2 1/2	5/16 non-threaded	50
PCD7B	3	3	5/16 non-threaded	25
PCD8B	3 1/2	3 1/2	5/16 non-threaded	25
PCD9B	4	4	1/2 non-threaded	10



StrongHold™ Cable/Conduit Part Numbers

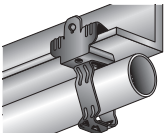
Snap-Close Conduit Clips with Beam Clamps – Bottom Mount



- Suspend conduit from bottom of beam
- Will pivot 360°
- Hammer-on installation
- Static load capacity: 75 lbs. vertically



Part Number	Flange Thickness (In.)	Fits EMT/Rigid/IMC (In.)	Std. Pkg. Qty.
P6M24	1/8 – 1/4	3/8	100
P6M58	5/16 – 1/2	3/8	100
P6M912	9/16 – 3/4	3/8	100
P812M24	1/8 – 1/4	1/2 – 3/4	100
P812M58	5/16 – 1/2	1/2 – 3/4	100
P812M912	9/16 – 3/4	1/2 – 3/4	100
P16M24	1/8 – 1/4	1	100
P16M58	5/16 – 1/2	1	100
P16M912	9/16 – 3/4	1	100
P20M24	1/8 – 1/4	1 1/4	100
P20M58	5/16 – 1/2	1 1/4	100
P20M912	9/16 – 3/4	1 1/4	100
P24M24	1/8 – 1/4	1 1/2	100
P24M58	5/16 – 1/2	1 1/2	100
P24M912	9/16 – 3/4	1 1/2	100
P32M24	1/8 – 1/4	2	100
P32M58	5/16 – 1/2	2	100
P32M912	9/16 – 3/4	2	100

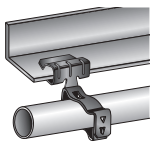


Snap-Close Conduit Clips with Beam Clamps – Side Mount

- Suspend conduit from side of beam
- Will pivot 360°
- Hammer-on installation
- Static load capacity: 25 lbs. vertically



Part Number	Flange Thickness (In.)	Fits EMT/Rigid/IMC (In.)	Std. Pkg. Qty.
P6M24SM	1/8 – 1/4	3/8	100
P6M58SM	5/16 – 1/2	3/8	100
P6M912SM	9/16 – 3/4	3/8	100
P812M24SM	1/8 – 1/4	1/2 – 3/4	100
P812M58SM	5/16 – 1/2	1/2 – 3/4	100
P812M912SM	9/16 – 3/4	1/2 – 3/4	100
P16M24SM	1/8 – 1/4	1	100
P16M58SM	5/16 – 1/2	1	100
P16M912SM	9/16 – 3/4	1	100
P20M24SM	1/8 – 1/4	1 1/4	100
P20M58SM	5/16 – 1/2	1 1/4	100
P20M912SM	9/16 – 3/4	1 1/4	100
P24M24SM	1/8 – 1/4	1 1/2	100
P24M58SM	5/16 – 1/2	1 1/2	100
P24M912SM	9/16 – 3/4	1 1/2	100
P32M24SM	1/8 – 1/4	2	100
P32M58SM	5/16 – 1/2	2	100
P32M912SM	9/16 – 3/4	2	100



StrongHold™ Cable/Conduit Part Numbers

Push-Fit Conduit Clips with Beam Clamps



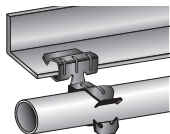
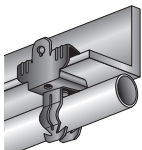
Image 1



Image 2

- Available in bottom mount or side mount options
- Will pivot 360°
- Hammer-on installation
- Static load capacity:
 - 25 lbs. vertically for bottom mount (Image 1)
 - 15 lbs. vertically for side mount (Image 2)

Part Number	Image No.	Flange Thickness (In.)	Fits EMT (In.)	Fits Rigid/IMC (In.)	Std. Pkg. Qty.
P8P24	1	1/8 – 1/4	1/2	—	100
P8P58	1	5/16 – 1/2	1/2	—	100
P8P912	1	9/16 – 3/4	1/2	—	100
P12P24	1	1/8 – 1/4	3/4	1/2	100
P12P58	1	5/16 – 1/2	3/4	1/2	100
P12P912	1	9/16 – 3/4	3/4	1/2	100
P16P24	1	1/8 – 1/4	1	3/4	100
P16P58	1	5/16 – 1/2	1	3/4	100
P16P912	1	9/16 – 3/4	1	3/4	100
P8P24SM	2	1/8 – 1/4	1/2	—	100
P8P58SM	2	5/16 – 1/2	1/2	—	100
P8P912SM	2	9/16 – 3/4	1/2	—	100
P12P24SM	2	1/8 – 1/4	3/4	1/2	100
P12P58SM	2	5/16 – 1/2	3/4	1/2	100
P12P912SM	2	9/16 – 3/4	3/4	1/2	100
P16P24SM	2	1/8 – 1/4	1	3/4	100
P16P58SM	2	5/16 – 1/2	1	3/4	100
P16P912SM	2	9/16 – 3/4	1	3/4	100



Cable Clips

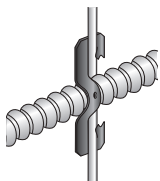


- Support MC, AC, or BX cable from #12 – #8 wire in horizontal or vertical position
- No static load rating – for positioning only
- Can also be used for flexible metallic tubing, armored cable, portable cables, and control tubes
- See chart below for installation configurations

Part Number	Description	Std. Pkg. Qty.
PKX	Cable clip to support MC, AC, or BX cable from drop wire.	100

Cable Size (In.)	#12 Wire	#10 Wire	#8 – #9 Wire
14-2 (0.43 – 0.48 O.D.)	PKX	PKX	PKX
14-3 (0.45 – 0.50 O.D.)	PKX	PKX	PKX
12-2 (0.47 – 0.51 O.D.)	PKX	PKX	PKX
12-3 (0.49 – 0.54 O.D.)	PKX	PK8*	PK8*

*See PK8 on Page A.7.



StrongHold™ Cable/Conduit Part Numbers

Conduit Clips



- Support conduit from drop wire, rod, or flange
- No static load rating – for positioning only
- Can also be used for flexible metallic tubing, armored cable, portable cables, and control tubes
- See chart below for installation configurations

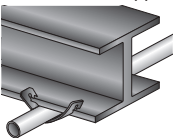


Part Number	Description	Std. Pkg. Qty.
PK8	Conduit clip to support 1/2" EMT from drop wire, rod, or flange.	100
PK12	Conduit clip to support 3/4" EMT from drop wire, rod, or flange.	100
PK16*	Conduit clip to support 1" EMT from drop wire, rod, or flange.	100
PK20*	Conduit clip to support 1 1/4" EMT drop wire, rod, or flange.	100

*Not UL or cUL listed.

Conduit Size (In.)	#10 – #12 Wire	#8 – #9 Wire	3/16" – 1/4" Rod	1/8" – 1/4" Flange	5/16" – 1/2" Flange	9/16" – 3/4" Flange
1/2 EMT	PK8	PK8	PK8	PK8	PK12	PK12
1/2 Rigid	PK8	PK12	PK12	PK12	PK12	PK16
3/4 EMT	PK12	PK12	PK12	PK12	PK16	PK16
3/4 Rigid	PK12	PK12	PK16	PK16	PK20*	PK20*
1 EMT	–	PK16	PK16	PK16	PK20*	PK20*
1 Rigid	–	–	–	PK20*	PK20*	PK20*
1 1/4 EMT	–	PK20	PK20	PK20	–	–

*For horizontal applications only.



Multi-Function Clip Assemblies



Image 1



Image 2



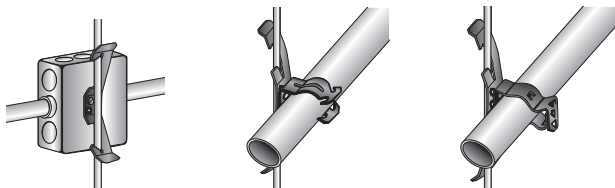
Image 3

- Components and assemblies used to secure conduit and devices to drop wire, rod, or flanges
- P4Z34 and assemblies fit 1/8" – 3/8" flanges and attach to #12 wire through 3/8" rod
- P6Z34 fits 1/8" – 7/16" flanges and attaches to #12 wire through 3/8" rod with improved performance
- No static load rating – for positioning only

Part Number	Image No.	Fits EMT (In.)	Fits Rigid/IMC (In.)	Std. Pkg. Qty.
P4Z34*	1	—	—	100
P6Z34*	1	—	—	100
P4Z348P	2	1/2	—	100
P4Z3412P	2	3/4	1/2	100
P4Z3416P	2	1	3/4	100
P4Z34812M	3	1/2 – 3/4	1/2 – 3/4	100
P4Z3416M	3	1	1	100

*UL and cUL listed.

Note: May require dedicated drop wire/rod and PEC311 – consult local authority.



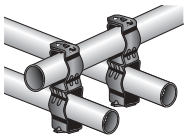
Conduit-To-Conduit Trapeze Assemblies with Snap-Close Clips



- Designed to quickly secure one conduit run to another
- No fasteners required
- Static load capacity: Total trapeze must not exceed 100 lbs.

Part Number	Fits EMT/Rigid/IMC (In.)	Std. Pkg Qty.
P166M	3/8* to 1	100
P16812M	1/2 – 3/4 to 1	100
P1616M	1 to 1	100
P1620M	1 1/4 to 1	100
P1624M	1 1/2 to 1	100

*Or 14-2 through 12-3 MC/AC cable.

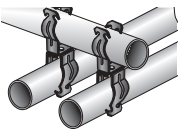


Conduit-To-Conduit Trapeze Assemblies with Push-Fit Clips



- Designed to quickly secure one conduit run to another
- No fasteners required
- Static load capacity: 25 lbs.
- Top conduit to be used for support only

Part Number	Fits EMT (In.)	Fits Rigid/IMC (In.)	Std. Pkg. Qty.
P8P8P	1/2 to 1/2	—	100
P8P12P	1/2 to 3/4	—	100
P8P16P	1/2 to 1	—	100
P12P12P	3/4 to 3/4	1/2 to 1/2	100
P12P16P	3/4 to 1	1/2 to 3/4	100
P16P16P	1 to 1	3/4 to 3/4	100

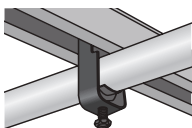


One-Piece Strut Clamps

- Used to mount conduit to strut
- All sizes available with load distribution saddle attached to screw to distribute weight
- Suitable for use with standard 1 5/8" strut
- Install with screwdriver, nut driver, or standard wrench



Part Number	Fits EMT (In.)	Fits Rigid/IMC (In.)	Static Load Capacity (Lbs.)	Std. Pkg. Qty.
PSCH6B	3/8	—	—	100
PSCH8B	1/2	—	50	100
PSCH12B	3/4	1/2	50	50
PSCH16B	1	3/4	59	50
PSCH20B	1 1/4	1	75	50
PSCH24B	1 1/2	1 1/4	80	50
PSCH32B	2	1 1/2	100	25
PSCH40B	—	2	80	25
PSCH48B	2 1/2	2 1/2	125	25
PSCH56B	3	3	160	10
PSCH64B	3 1/2	3 1/2	200	10
PSCH72B	4	4	330	10

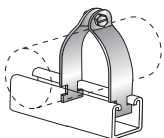


Universal Strut Clamps



- Break-apart strut clamp
- Install with screwdriver, nut driver, or standard wrench
- Suitable for use with standard 1 5/8" strut
- Material: mild steel

Part Number	Fits EMT/Rigid/IMC (In.)	Static Load Rating (Lbs.)	Std. Pkg. Qty.
PSK85I	1/2	200	100
PSK125I	3/4	200	100
PSK165I	1	200	100
PSK205I	1 1/4	200	100
PSK245I	1 1/2	200	50
PSK325I	2	200	50
PSK405I	2 1/2	350	50
PSK485I	3	350	50
PSK565I	3 1/2	350	25
PSK645I	4	350	25



Combination Box/Conduit Hangers from Drop Wire, Rod, and Beams



Image 1

- Secure 3/8" conduit (MC/AC cable) and 4" square boxes to most structures
- Provide 3/8" conduit (MC/AC cable) support on both sides of electrical box
- Available in a variety of mounting configurations



Image 2



Image 3



Image 4

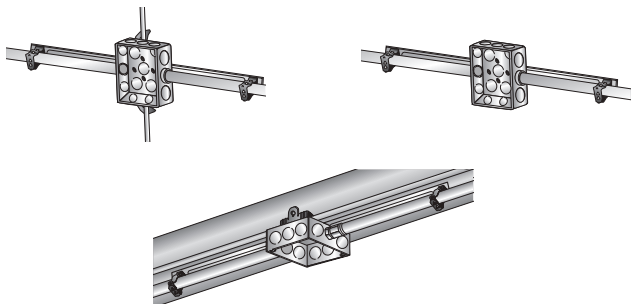
Part Number	Image No.	Mounting Method	Fits EMT/Rigid/IMC (In.)	Std. Pkg. Qty.
P6MB18	1	#12 wire through 1/4" flange	3/8*	25
P6MB18A	2	Non-threaded center hole for screw or threaded rod mount	3/8*	25
P812MB18	1	#12 wire through 1/4" rod	1/2 – 3/4	25
P812MB18A	2	Non-threaded center hole for screw or threaded rod mount	1/2 – 3/4	25
P812MB1824	3	1/8" through 1/4" flange	1/2 – 3/4	25

*Or 14-2 through 12-3 MC/AC cable.

StrongHold™ Cable/Conduit Part Numbers

Combination Box/Conduit Hangers from Drop Wire, Rod, and Beams (continued)

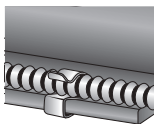
Part Number	Image No.	Mounting Method	Fits EMT/Rigid/IMC (In.)	Std. Pkg. Qty.
P812MB18S	4	1/4-20 x 9/16" stud in center hole	1/2 – 3/4	25
P16MB18	1	#12 wire through 1/4" rod	1	25
P16MB18A	2	Non-threaded center hole for screw or threaded rod mount	1	25



Flexible Conduit/Cable Clips

- Suitable for flexible conduit and all types of cable
- Support cable from 1/16" – 1/2" flange
- No static load rating – for positioning only
- Clip "snaps" on flange and cable "snaps" into clip

Part Number	AC/MC Cable O.D. (In.)	Flange Size (In.)	Std. Pkg. Qty.
PSC2A	0.22 – 0.28	1/16 – 3/16	100
PSC2B	0.31 – 0.38	1/16 – 3/16	100
PSC2C	0.38 – 0.44	1/16 – 3/16	100
PSC2D	0.47 – 0.56	1/16 – 3/16	100
PSC2E	0.50 – 0.72	1/16 – 3/16	100
PSC2F	0.75 – 0.94	1/16 – 3/16	100
PSC2G	0.97 – 1.25	1/16 – 3/16	100
PSC4A	0.22 – 0.28	3/16 – 9/32	100
PSC4B	0.31 – 0.38	3/16 – 9/32	100
PSC4C	0.38 – 0.44	3/16 – 9/32	100
PSC4D	0.47 – 0.56	3/16 – 9/32	100
PSC4E	0.50 – 0.72	3/16 – 9/32	100
PSC4F	0.75 – 0.94	3/16 – 9/32	100
PSC4G	0.97 – 1.25	3/16 – 9/32	100
PSC8A	0.22 – 0.28	5/16 – 1/2	100
PSC8B	0.31 – 0.38	5/16 – 1/2	100
PSC8C	0.38 – 0.44	5/16 – 1/2	100
PSC8D	0.47 – 0.56	5/16 – 1/2	100
PSC8E	0.50 – 0.72	5/16 – 1/2	100
PSC8F	0.75 – 0.94	5/16 – 1/2	100
PSC8G	0.97 – 1.25	5/16 – 1/2	100

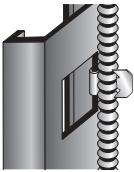


Flexible Cable Clip



- Push clip to attach MC or AC cable to metal stud
- No tools required for installation
- Provides fast installation

Part Number	Cable Size (In.)	Std. Pkg. Qty.
P449	12-2 (0.47 – 0.51 O.D.)	100
	12-3 (0.49 – 0.54 O.D.)	
	14-2 (0.43 – 0.48 O.D.)	
	14-3 (0.46 – 0.50 O.D.)	



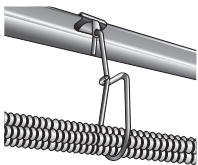
Flexible Conduit/Cable Hangers



- Bundle runs of MC and AC cable
- Can be used with variety of mounting hardware
- Easy to close without the use of tools



Part Number	Description	Ultimate Load (Lbs.)	Std. Pkg. Qty.
PWMX3	Cable hanger for 1 1/8" diameter bundle – 3 runs of MC/AC.	50	100
PWMX6	Cable hanger for 1 3/4" diameter bundle – 6 runs of MC/AC.	75	100



**Support Brackets
for MC/AC Cable**

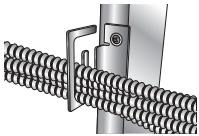
Mount with
self-tapping screws
found on page G.18!

**Image 1****Image 2**

- Properly space and support MC/AC cable
- Prevent derating of electrical cable
- Comply with NEC Article 310.15 (reference pages K.4 – K.5 for details)



Part Number	Image No.	Capacity	Std. Pkg. Qty.
PMCS50	1	Up to 4 runs of MC/AC cable 0.43" – 0.56" in diameter	100
PMCS100	2	Up to 8 runs of MC/AC cable 0.43" – 0.56" in diameter	50
PMCS101	2	Up to 7 runs of MC/AC cable 0.56" – 0.69" in diameter	50



StrongHold™ Cable/Conduit Part Numbers

Nail/Conduit Brackets



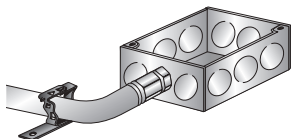
Image 1



Image 2

- Attach conduit to wood, steel, and concrete
- Eliminate offset bends on 1 1/2" box
- No static load rating – for positioning only
- May be attached after positioning conduit

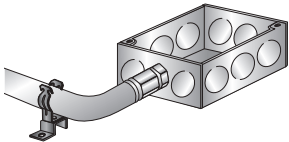
Part Number	Image No.	Fits EMT (In.)	Fits Rigid/IMC (In.)	Std. Pkg. Qty.
PCNB812M	1	1/2 – 3/4	1/2 – 3/4	100
PCNB8P	2	1/2	—	100
PCNB12P	2	3/4	1/2	100



Metal Deck/Conduit Brackets

- Provide spacing between conduit and deck surface
- Eliminate offset bends on 2 1/8" box
- No static load rating – for positioning only
- May be attached after positioning conduit

Part Number	Fits EMT (In.)	Fits Rigid/IMC (In.)	Std. Pkg. Qty.
PAOL8P	1/2	—	100
PAOL12P	3/4	1/2	100
PAOL16P	1	3/4	100



Screw-On Beam Clamps



PBC

- Attach to beam with screw
- Install with screwdriver, nut driver, or standard wrench
- Incorporate tapped holes to accommodate threaded rod



PBC200

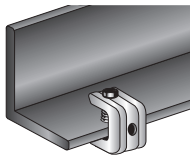
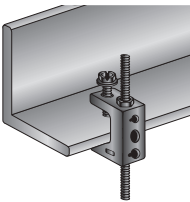


PBC400

Part Number	Flange Thickness (In.)	Tapped Hole	Static Load Rating (Lbs.)	Material	Std. Pkg. Qty.
PBC*	Up to 1/2	1/4-20 in back and bottom; #10-24 in back	100	Spring Steel	100
PBC200	Up to 1/2	1/4-20 in back and bottom	100	Zinc Plated Steel	50
PBC400**	Up to 15/16	3/8-16 in back and bottom	200	Zinc Plated Steel	25

*3/8" non-threaded clearance hole in top and bottom; 1/4" non-threaded clearance hole in back.

**UL and cUL listed.

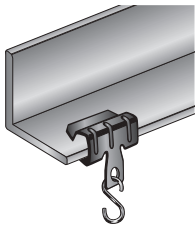


Hammer-On Beam Clamps with Attachment Tab

- Hammer-on installation
- Attachment tab provides 1/4" clearance hole for wire, S-hooks, or chain assemblies
- Static load capacity: 200 lbs.



Part Number	Flange Thickness (In.)	Std. Pkg. Qty.
P4H24	1/8 – 1/4	100
P4H58	5/16 – 1/2	100
P4H912	9/16 – 3/4	100



StrongHold™ Beam/Purlin Part Numbers

Hammer-On Beam Clamps



Image 1

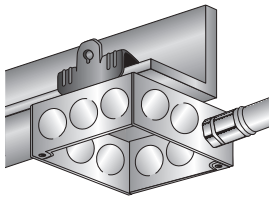
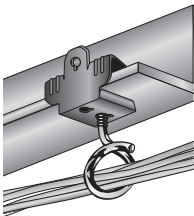


Image 2

- Hammer-on installation
- Provided with a 1/4-20 thread so that boxes, fixtures, and bridle rings may be quickly and securely attached to the beam flanges (Image 1)
- Also available with 1/4-20 x 3/8" staked stud for easier attachment of outlet boxes to beams; eliminates need to use additional screws (Image 2)
- Static load capacity: 75 lbs.



Part Number	Image No.	Flange Thickness (in.)	Std. Pkg. Qty.
PM24	1	1/8 – 1/4	100
PM58	1	5/16 – 1/2	100
PM912	1	9/16 – 3/4	100
PM24S	2	1/8 – 1/4	100
PM58S	2	5/16 – 1/2	100
PM912S	2	9/16 – 3/4	100



Reversible Beam Clamps



Image 1

- Used when drop-rod length must be adjusted to accommodate a finished height in the field
- Jam nut included to prevent vibratory loosening
- Manufactured from malleable iron



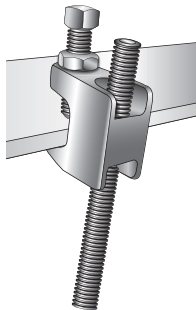
Image 2



Image 3



Part Number	Image No.	Flange Thickness (In.)	Threaded Hole	Std. Pkg. Qty.
P3000037EG	1	3/4	3/8-16	25
P3000050EG	1	3/4	1/2-13	25
P3100037EG	2	1 1/4	3/8-16	25
PBC260025EG	3	1 1/4	1/4-20	50



StrongHold™ Beam/Purlin Part Numbers

Spring Steel Screw-On Beam Clamp Assemblies



Image 1

- Easily attach conduit to beams
- Can be installed on flange up to 1/2" thick
- Include snap-close or push-fit conduit fittings



Image 2

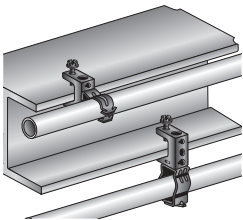


Image 3



Image 4

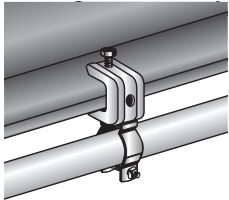
Part Number	Image No.	Fits EMT (In.)	Fits Rigid/IMC (In.)	Static Load Rating (Lbs.)	Std. Pkg. Qty.
PBC8P	1	1/2	—	25	100
PBC12P	1	3/4	1/2	25	100
PBC16P	1	1	3/4	25	100
PBC8PSM	2	1/2	—	15	100
PBC12PSM	2	3/4	1/2	15	100
PBC16PSM	2	1	3/4	15	100
PBC812M	3	1/2 – 3/4	1/2 – 3/4	100	100
PBC16M	3	1	1	100	100
PBC20M	3	1 1/4	1 1/4	100	100
PBC24M	3	1 1/2	1 1/2	100	100
PBC32M	3	2	2	100	100
PBC812MSM	4	1/2 – 3/4	1/2 – 3/4	25	100
PBC16MSM	4	1	1	25	100
PBC20MSM	4	1 1/4	1 1/4	25	100
PBC24MSM	4	1 1/2	1 1/2	25	100
PBC32MSM	4	2	2	25	100



**Screw-On Beam Clamp Assemblies with
Conduit Clamps**

- Easily attach conduit to beams up to 1/2" thick
- Conduit clamps provide positive securing feature
- Suitable for EMT or Rigid/IMC conduit

Part Number	Fits EMT (In.)	Fits Rigid/IMC (In.)	Std. Pkg. Qty.
PBC200CD1B	3/4	3/4	100
PBC200CD2B	1	1	100
PBC200CD2.5B	1 1/4	—	100
PBC200CD3B	1 1/2	1 1/4	100
PBC200CD4B	—	1 1/2	50
PBC200CD5B	2	2	50



StrongHold™ Beam/Purlin Part Numbers

Hammer-On Beam Clamps with Rod Hanger



Image 1

- Hammer-on beam clamps allow for easy installation
- Options available for threaded or non-threaded rod
- Options available for flanges 1/8" – 3/4" thick
- Static load capacity: 160 lbs.



Image 2



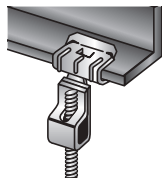
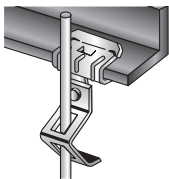
Image 3



Image 4

Part Number	Image No.	Flange Thickness (In.)	Rod Size	Std. Pkg. Qty.
P4TI24	1	1/8 – 1/4	1/4-20 threaded	100
P4TI58	1	5/16 – 1/2	1/4-20 threaded	100
P4TI912	1	9/16 – 3/4	1/4-20 threaded	100
P6TI24	1	1/8 – 1/4	3/8-16 threaded	100
P6TI58	1	5/16 – 1/2	3/8-16 threaded	100
P6TI912	1	9/16 – 3/4	3/8-16 threaded	100
P6TA24*	2	1/8 – 1/4	1/4" – 3/8"; requires nuts	100
P6TA58*	2	5/16 – 1/2	1/4" – 3/8"; requires nuts	100
P6A24	3	1/8 – 1/4	3/8" non-threaded	100
P6A58	3	5/16 – 1/2	3/8" non-threaded	100
P6A912	3	9/16 – 3/4	3/8" non-threaded	100
P70824	4	1/8 – 1/4	8 wire or 1/4" plain rod	100
P70858	4	5/16 – 1/2	8 wire or 1/4" plain rod	100
P708912	4	9/16 – 3/4	8 wire or 1/4" plain rod	100

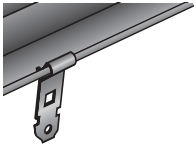
*UL and cUL listed.



Purlin Clips – Spring Steel**PVF14****PAF14**

- Fasteners fit flanges 1/16" – 1/4" thick
- Support wire and assemblies from vertical or angled flanges
- Hammer-on installation
- Material: spring steel
- Static load capacity: 100 lbs.

Part Number	Flange Orientation	Std. Pkg. Qty.
PVF14	Vertical	100
PAF14	Angled	100



Z-Purlin Clips



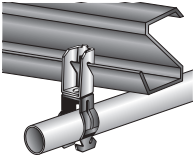
P122

- Provide a method for attaching conduit and boxes to angled flanges
- Installed by hand without the use of power tools
- Static load capacity: 100 lbs.



P123

Part Number	Description	Std. Pkg. Qty.
P122	1/4" hole for wire, S-hooks, and jack chain.	100
P123	1/4" hole in bottom for assemblies.	100



Purlin Clip Assemblies for Threaded Rod and Drop Wire Applications



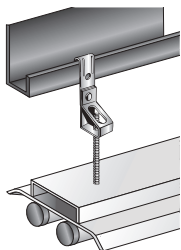
Image 1

- Suspend threaded rod and drop wire from vertical flange
- Hammer-on installation
- Material: spring steel
- Static load capacity: 160 lbs.
- Flange thickness: 1/16" – 5/32"



Image 2

Part Number	Image No.	Rod Size	Std. Pkg. Qty.
PVF144TI	1	1/4-20 threaded	100
PVF146TI	1	3/8-16 threaded	100
PVF146T	1	1/4" – 3/8" requires nuts	100
PVF14708	2	#8 wire or 1/4" plain rod	100



Z-Purlin Clip Assemblies for Conduit Applications



Image 1

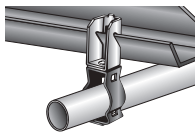
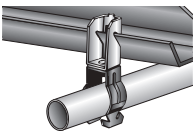
- Provide a method for attaching conduit to angled flanges
- Installed by hand without the use of power tools



Image 2

Part Number	Image No.	Fits EMT (In.)	Fits Rigid/IMC (In.)	Static Load Rating (Lbs.)	Std. Pkg. Qty.
P1238P	1	1/2	—	25	100
P12312P	1	3/4	1/2	25	100
P12316P	1	1	3/4	25	100
P1236M	2	3/8	3/8	100	100
P123812M	2	1/2 – 3/4	1/2 – 3/4	100	100
P12316M*	2	1	1	100	100
P12320M	2	1 1/4	1 1/4	100	100

*UL and cUL listed.

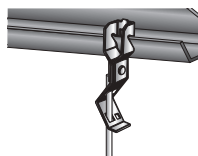
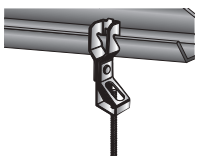


**Z-Purlin Clip Assemblies for Threaded Rod
and Drop Wire Applications****Image 1**

- Provide a method for attaching conduit and boxes to angled flanges
- Installed by hand without the use of power tools
- Static load capacity: 100 lbs.

**Image 2****Image 3**

Part Number	Image No.	Rod Size	Std. Pkg. Qty.
P1224TI	1	1/4-20 threaded	100
P1226TI	1	3/8-16 threaded	100
P1226T	2	1/4" – 3/8" threaded; requires nuts	100
P122708	3	#8 wire or 1/4" plain rod	100



Rod and Wire Hangers with Bracket Supports



Image 1

- Suspend #8 wire, 1/4", and 3/8" non-threaded or threaded rod from overhead mountings
- 1/4" clearance hole in right angle and offset brackets
- Static load capacity: 160 lbs.



Image 2



Image 3



Image 4



Image 5

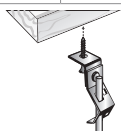
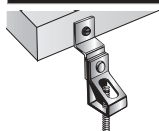


Image 6



Image 7

Part Number	Image No.	Rod Size	Bracket Orientation	Std. Pkg. Qty.
P4TIB	1	1/4-20 threaded rod	Right Angle	100
P6TIB	1	3/8-16 threaded rod	Right Angle	100
P6TB	2	1/4" – 3/8" threaded rod; requires nut	Right Angle	100
P6AO	3	3/8 non-threaded rod	Offset	100
P4TIO	4	1/4-20 threaded rod	Offset	100
P6TIO	4	3/8-16 threaded rod	Offset	100
P6TO	5	1/4" – 3/8" threaded rod; requires nut	Offset	100
P708AB	6	#8 wire or 1/4" plain rod	Right Angle	100
P708AO	7	#8 wire or 1/4" plain rod	Offset	100



StrongHold™ Hangers/Hanging Systems Part Numbers

Strap Hangers



Image 1

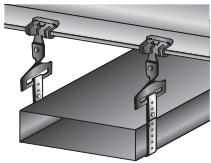


Image 2

- Support pipe or duct from flange with banding or strapping up to 1" wide
- Options available for beams 1/8" – 3/4" thick
- Hammer-on installation
- Static load capacity: 200 lbs.



Part Number	Image No.	Flange Thickness (In.)	Std. Pkg. Qty.
PMSS24	1	1/8 – 1/4	100
PMSS58	1	5/16 – 1/2	100
PMSS912	1	9/16 – 3/4	100
PMSR24	2	1/8 – 1/4	100
PMSR58	2	5/16 – 1/2	100
PMSR912	2	9/16 – 3/4	100



Mount with
self-tapping screws
found on page G.18!

Electrical Box Mounting Support Brackets

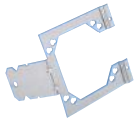


Image 1

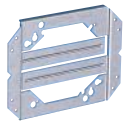
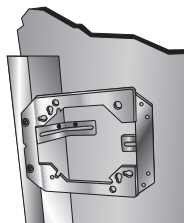
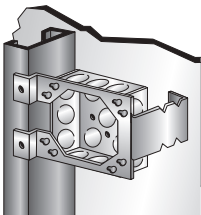


Image 2

- Attach 4" or 4 11/16" electrical outlet boxes to studs
- Support feature reduces box movement in wall
- Manufactured from pre-galvanized steel
- Comply with NEC Article 300.4 (D) (reference pages N.1 for details)

Part Number	Image No.	Stud Depth (In.)	Std. Pkg. Qty.
PH23	1	2 1/2 and 3 1/2	100
PH4	1	2 1/2, 3 1/2, and 4	100
PH6	1	6	100
PMEB1	2	2 1/2, 3 1/2, and 4	25



Screw-On Conduit Supports

Mount with
self-tapping screws
found on page G.18!

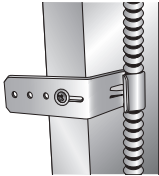


- Comply with NEC Article 358.30 to support conduit close to electrical box
- Accommodate EMT and MC/AC cable
- Allow conduit to align with box knockouts when used with PH series brackets (see page D.1)



Part Number	Fits EMT (In.)	Electrical Box Depth	Color	Std. Pkg. Qty.
PCS16*	1	2 1/8	Black	100
PCS812	1/2 – 3/4	1 1/2	Black	100
PCS812D	1/2 – 3/4	2 1/8	Silver	100

*Not UL or cUL listed.

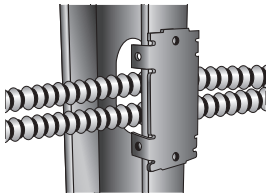


Press-On Nail Plate



- Fast installation; no tools required
- Protects electrical, datacom, and plumbing infrastructure
- Meets NEC Article 300.4 requirements (reference pages N.1 for details)

Part Number	Description	Std. Pkg. Qty.
P304B2	Press-on nail plate for wood or metal studs.	100



StrongHold™ Stud Wall Part Numbers

Hammer-On Box to Stud Supports

Mount with
self-tapping screws
found on page G.18!



PMSF

- Secure electrical boxes to most metal studs
- Include 1/4" hole to secure to stud with user-supplied screw
- Hammer-on installation

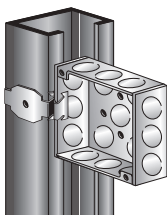


PMFS



PMFO

Part Number	Description	Std. Pkg. Qty.
PMSF	Box to stud support – non-adjustable.	100
PMFS	Box to stud support with screw, adjustable for 1/4" – 3/4" dry wall.	100
PMFO	Box to stud support flush to stud face – preset.	100



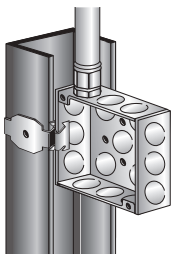
**Switch Box to Metal
Stud Brackets**

Mount with
self-tapping screws
found on page G.18!



- Secure electrical boxes to most metal studs
- Preset versions offset for specific dry wall thickness
- Include 1/4" hole to secure to stud with user-supplied screw
- Hammer-on installation

Part Number	Dry Wall Thickness (In.)	Std. Pkg. Qty.
PMF250	1/4	100
PMF375	3/8	100
PMF500	1/2	100
PMF625	5/8	100
PMF750	3/4	100



StrongHold™ Stud Wall Part Numbers

Hammer-On Conduit to Metal Stud Brackets

Mount with
self-tapping screws
found on page G.18!



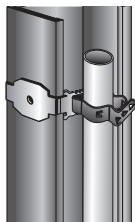
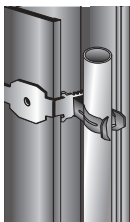
Image 1

- Designed to quickly install conduit to metal studs
- Available in push-fit (Image 1) or snap-close (Image 2) fittings
- Suitable for both EMT and Rigid/IMC conduit



Image 2

Part Number	Image No.	Fits EMT (In.)	Fits Rigid/IMC (In.)	Std. Pkg. Qty.
P8PF	1	1/2	—	100
P12PF	1	3/4	1/2	100
P16PF	1	1	3/4	100
P6MF	2	3/8	3/8	100
P812MF	2	1/2 – 3/4	1/2 – 3/4	100
P16MF	2	1	1	100



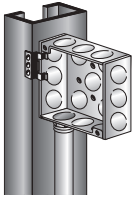
Screw-On Box to Stud Support

Mount with self-tapping screws found on page G.18!



- Installs to stud with user-supplied screws
- For use with metal or wood studs
- Used independently or with assemblies for electrical box or conduit support

Part Number	Description	Std. Pkg. Qty.
P350	Screw-mounted box to stud support.	100



Screw-On Conduit to Stud Supports

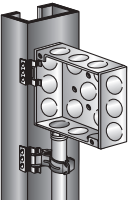
Mount with self-tapping screws found on page G.18!



Image 1 Image 2

- Designed to install runs of conduit to metal studs
- Suitable for EMT and Rigid/IMC conduit
- Available in push-fit (Image 1) or snap-close (Image 2) fittings

Part Number	Image No.	Fits EMT (In.)	Fits Rigid/IMC (In.)	Std. Pkg. Qty.
P3508P	1	1/2	—	100
P35012P	1	3/4	1/2	100
P35016P	1	1	3/4	100
P350812M	2	1/2 – 3/4	1/2 – 3/4	100
P35016M	2	1	1	100



StrongHold™ Stud Wall Part Numbers

Far-Side Box Supports

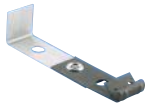


Image 1



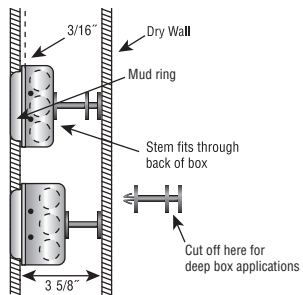
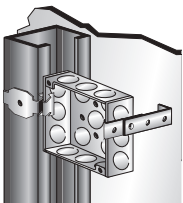
Image 2

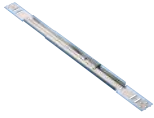


Image 3

- Clip to electrical box to utilize dry wall on far side of box for support
- Used with 1 1/2" or 2 1/8" deep electrical box
- Prevent electrical box from recessing into wall cavity
- No static load rating – for positioning only

Part Number	Image No.	Figure No.	Stud Depth (In.)	Std. Pkg. Qty.
PJ1A25	1	1	2 1/2	100
PJ1A35	1	1	3 1/2	100
PJ1A4	1	1	4	100
PJ1A6	1	1	6	100
P766	2	1	2 1/2 – 4	100
P766PMD	3	2	3 5/8	100

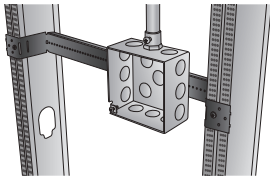


**Adjustable Screw Gun
Box Mounting Brackets****Mount with
self-tapping screws
found on page G.18!**

- Adjustable to allow variability between stud spacing
- Utilized to mount electrical box between studs
- Suitable for 1 1/2" or 2 1/8" deep electrical boxes



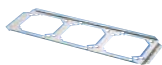
Part Number	Description	Std. Pkg. Qty.
PTSGB16	Mount box between studs spaced 11" – 18".	50
PTSGB24	Mount box between studs spaced 17" – 26".	50



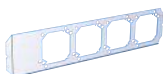
StrongHold™ Stud Wall Part Numbers

Rigid Box Mounting Brackets

Mount with
self-tapping screws
found on page G.18!



PRBS16



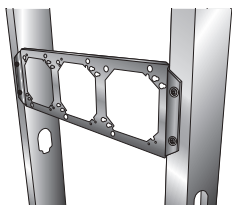
PRBS24

- Used to secure multiple electrical boxes in stud walls
- Mount 1 1/2" or 2 1/8" deep electrical boxes
- Suitable for 4" or 4 11/16" wide electrical boxes



Part Number	Description	Std. Pkg. Qty.
PRBS16	Rigid box mounting bracket for 16" stud spacing; capacity of three electrical boxes.	50
PRBS24*	Rigid box mounting bracket for 24" stud spacing; capacity of four electrical boxes.	25

*Not UL or cUL listed.



**Stud-Mounted Box
Support Brackets**

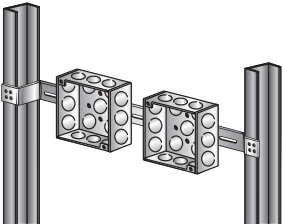
Mount with
self-tapping screws
found on page G.18!



- User-supplied self-tapping screws attach box to bracket
- Manufactured from pre-galvanized steel

PSGB16A

Part Number	Description	Std. Pkg. Qty.
PSGB16A	Mounts 2 1/2" deep electrical boxes to studs on 16" centers.	50
PSGB24A	Mounts 2 1/2" deep electrical boxes to studs on 24" centers.	50

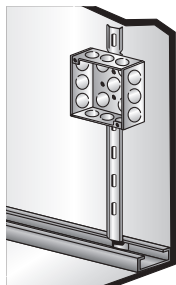


Floor-Mounted Box Support Bracket – Variable Height



- Bracket to support electrical boxes from floor or channels
- Break-away feature allows product to be used at three heights
- Manufactured from pre-galvanized steel

Part Number	Description	Std. Pkg. Qty.
PFBS18	Box support bracket to mount electrical boxes at 12", 16", or 18" heights.	50



Floor-Mounted Box Bracket

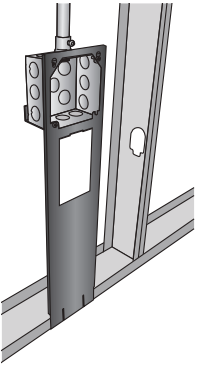
Mount with
self-tapping screws
found on page G.18!



- Supports electrical box at consistent spacing from floor level
- Features can be used to prevent electrical box from being pushed into wall cavity
- Mounts 4" or 4 11/16" wide electrical boxes; 1 1/2" or 2 1/8" deep
- Meets ADA (Americans with Disabilities Act) accessibility guidelines/standards



Part Number	Description	Std. Pkg. Qty.
PFMBS18	Floor-mounted box bracket to mount center of electrical box 18" off floor.	25



StrongHold™ Stud Wall Part Numbers

Cable Support Clip

Mount with self-tapping screws found on page G.18!

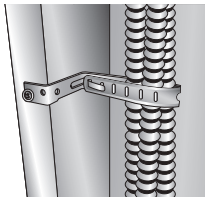


- Used to maintain appropriate cable spacing behind dry wall to comply with NEC Article 300.4 (D) (reference pages K.1 – K.2 for details)
- Attaches to wood or metal stud with user-supplied screws
- Accommodates a variety of cable types



Part Number	Description	Std. Pkg. Qty.
PCJ6	Cable support clip to provide 1 1/2" spacing for cables behind dry wall.	100

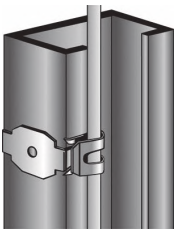
Cable Type	Cables Per Clip	Cable Size
Non-metallic	6	14-2, 12-2, 10-2, 14-3, 12-3, 10-3 with ground
Non-metallic	4	8-2, 6-2 with ground
MC/AC	4	14-2, 12-2, 10-2, 14-3, 12-3, 10-3, 14-4, 12-4, 10-4 with ground



**Cable Support Clip
for Single Cable****Mount with
self-tapping screws
found on page G.18!**

- Used to maintain appropriate cable spacing behind dry wall to comply with NEC Article 300.4 (D) (reference pages K.1 – K.2 for details)
- Provides 1 1/2" spacing for cables behind dry wall
- Attaches to wood or metal studs with hammer

Part Number	Description	Std. Pkg. Qty.
PFXC20	Accommodates MC/AC cable (12-2 through 10-3).	100



StrongHold™ Stud Wall Part Numbers

Through-Stud Conduit Supports

Mount with
self-tapping screws
found on page G.18!



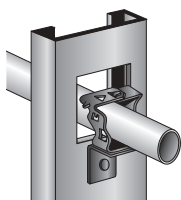
Image 1

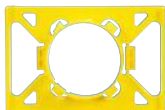


Image 2

- Designed to secure horizontal runs of conduit through metal studs
- Eliminate rattling conduit
- Available with push-fit (Image 1) or snap-close (Image 2) conduit fittings

Part Number	Image No.	Fits EMT (In.)	Fits Rigid/IMC (In.)	Std. Pkg. Qty.
PFB8P	1	1/2	—	100
PFB12P	1	3/4	1/2	100
PFB6M	2	3/8	3/8	100
PFB812M	2	1/2 – 3/4	1/2 – 3/4	100

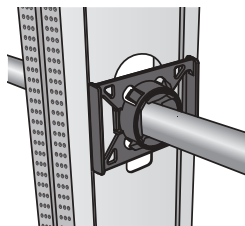


Metal Stud Grommets**MSG-1.3-C**

- Install in pre-punched hole in metal studs
- Protect cable within the building structure
- Utilize metal stud punch tool (see page D.18) to create suitable holes in specific locations

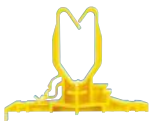
**MSGV-1.3-C**

Part Number	Description	Std. Pkg. Qty.
MSG-1.3-C	Metal stud grommet.	100
MSGV-1.3-C	Metal stud grommet, anti-vibration tabs for 1/2" – 1" pipe.	100



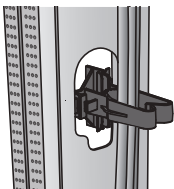
StrongHold™ Stud Wall Part Numbers

Cable Manager



- Installs in pre-punched hole in metal studs
- Protects cable within the building structure
- Utilizes metal stud punch tool (see page D.18) to create suitable holes in specific locations

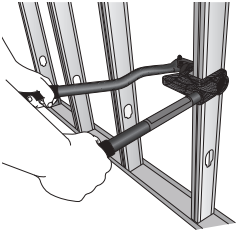
Part Number	Description	Std. Pkg. Qty.
CSM-1.25-C	Cable stud manager for 1 1/4" cable spacing.	100



Metal Stud Punch Tool

- Punches 1 11/32" round hole in 25 gauge minimum to 20 gauge maximum mild steel studs
- Contoured handle allows for increased leverage
- Automatic hole centering on standard width (3 5/8") studs
- Replaceable punch and dies
- Self-stripping design that eliminates punch malfunctions

Part Number	Description	Std. Pkg. Qty.
MSPT-1.3	Metal stud punch tool.	1

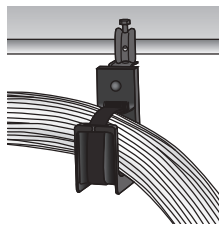
**Self-Tapping Screw**

- Used to secure StrongHold™ components to metal studs
- Low profile head utilizes #2 Phillips head
- Packaging: plastic job jar

Part Number	Description	Std. Pkg. Qty.
PSMS8	8 x 1/2" low profile self-tapping screw.	1000

J-Pro™ Series Referenced Images

- UL listed for use in plenum or air handling spaces (such as ceiling voids and underfloor areas) per NEC Article 300.22 (C) and (D) (reference pages N.2 – N.4 for details)
- Complete horizontal and vertical 1" bend radius control

**Image 1****Image 2****Image 3****Image 4****Image 5****Image 6****Image 7****Image 8****Image 9****Image 10****Image 11****Image 12**

J-Pro™ JP75 Series

- Bundle capacity: 3/4"
- Cable capacity: Category 6A (5), Category 6A (SD) (8), Category 6 (8), Category 5e (10)

Part Number	Image No.	Description	Std. Pkg. Qty.
JP75W-L20	1	Wall mount – one 1/4" mounting hole.	50
JP75WP2B-L20	2	Wall mount for powder actuated fasteners – one 5/32" and one 1/4" mounting hole.	50
JP75CMB-L20	3	Ceiling mount – 3/16", 1/4", and 3/8" mounting holes.	50
JP75DW-L20	4	Drop wire and threaded rod clip mount.	50
JP75SBC50-L20	5	Screw-on beam clamp mount – up to 1/2" flange.	50
JP75SBC50RB-L20	6	Screw-on beam clamp mount – up to 1/2" flange. Rotates 360°.	50
JP75SBC87-L20	7	Screw-on beam clamp mount – up to 3/4" flange.	50
JP75SBC87RB-L20	8	Screw-on beam clamp mount – up to 3/4" flange. Rotates 360°.	50
JP75HBC25RB-L20	9	Hammer-on beam clamp mount – 1/8" - 1/4" flange. Rotates 360°.	50
JP75HBC50RB-L20	9	Hammer-on beam clamp mount – 5/16" – 1/2" flange. Rotates 360°.	50
JP75HBC75RB-L20	9	Hammer-on beam clamp mount – 9/16" – 3/4" flange. Rotates 360°.	50
JP75CP-L20	10	C-purlin clips for straight flanges up to 1/4" thick.	50
JP75ZP-L20	11	Z-purlin clips for angled flanges up to 1/4" thick.	50
JP75UF100-L20	12	Underfloor pedestal support clip for pedestal 7/8" square or 1 1/8" – 1 3/8" in diameter.	50

J-Pro™ JP131 Series

- Bundle capacity: 1 5/6"
- Cable capacity: Category 6A (15), Category 6A (SD) (25), Category 6 (25), Category 5e (29)

Part Number	Image No.	Description	Std. Pkg. Qty.
JP131W-L20	1	Wall mount – one 1/4" mounting hole.	50
JP131WP2B-L20	2	Wall mount for powder actuated fasteners – one 5/32" and one 1/4" mounting hole.	50
JP131CMB-L20	3	Ceiling mount – 3/16", 1/4", and 3/8" mounting holes.	50
JP131DW-L20	4	Drop wire and threaded rod clip mount.	50
JP131SBC50-L20	5	Screw-on beam clamp mount – up to 1/2" flange.	50
JP131SBC50RBL20	6	Screw-on beam clamp mount – up to 1/2" flange. Rotates 360°.	50
JP131SBC87-L20	7	Screw-on beam clamp mount – up to 3/4" flange.	50
JP131SBC87RBL20	8	Screw-on beam clamp mount – up to 3/4" flange. Rotates 360°.	50
JP131HBC25RBL20	9	Hammer-on beam clamp mount – 1/8" – 1/4" flange. Rotates 360°.	50
JP131HBC50RBL20	9	Hammer-on beam clamp mount – 5/16" – 1/2" flange. Rotates 360°.	50
JP131HBC75RBL20	9	Hammer-on beam clamp mount – 9/16" – 3/4" flange. Rotates 360°.	50
JP131CP-L20	10	C-purlin clips for straight flanges up to 1/4" thick.	50
JP131ZP-L20	11	Z-purlin clips for angled flanges up to 1/4" thick.	50
JP131UF100-L20	12	Underfloor pedestal support clip for pedestal 7/8" square or 1 1/8" – 1 3/8" in diameter.	50

J-Pro™ JP2 Series

- Bundle capacity: 2"
- Cable capacity: Category 6A (30), Category 6A (SD) (46), Category 6 (46), Category 5e (55)

Part Number	Image No.	Description	Std. Pkg. Qty.
JP2W-L20	1	Wall mount – one 1/4" mounting hole.	50
JP2WP2B-L20	2	Wall mount for powder actuated fasteners – one 5/32" and one 1/4" mounting hole.	50
JP2CMB-L20	3	Ceiling mount – 3/16", 1/4", and 3/8" mounting holes.	50
JP2DW-L20	4	Drop wire and threaded rod clip mount.	50
JP2SBC50-L20	5	Screw-on beam clamp mount – up to 1/2" flange.	50
JP2SBC50RB-L20	6	Screw-on beam clamp mount – up to 1/2" flange. Rotates 360°.	50
JP2SBC87-L20	7	Screw-on beam clamp mount – up to 3/4" flange.	50
JP2SBC87RB-L20	8	Screw-on beam clamp mount – up to 3/4" flange. Rotates 360°.	50
JP2HBC25RB-L20	9	Hammer-on beam clamp mount – 1/8" – 1/4" flange. Rotates 360°.	50
JP2HBC50RB-L20	9	Hammer-on beam clamp mount – 5/16" – 1/2" flange. Rotates 360°.	50
JP2HBC75RB-L20	9	Hammer-on beam clamp mount – 9/16" – 3/4" flange. Rotates 360°.	50
JP2CP-L20	10	C-purlin clips for straight flanges up to 1/4" thick.	50
JP2ZP-L20	11	Z-purlin clips for angled flanges up to 1/4" thick.	50
JP2UF100-L20	12	Underfloor pedestal support clip for pedestal 7/8" square or 1 1/8" – 1 3/8" in diameter.	50

J-Pro™ JP4 Series

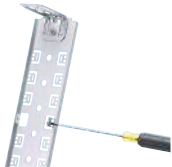
- Bundle capacity: 4"
- Cable capacity: Category 6A (115), Category 6A (SD) (180), Category 6 (180), Category 5e (200)

Part Number	Image No.	Description	Std. Pkg. Qty.
JP4W-X20	1	Wall mount – one 1/4" mounting hole.	10
JP4WP2B-X20	2	Wall mount for powder actuated fasteners – one 5/32" and one 1/4" mounting hole.	10
JP4CMB-X20	3	Ceiling mount – 3/16", 1/4", and 3/8" mounting holes.	10
JP4SBC50-X20	5	Screw-on beam clamp mount – up to 1/2" flange.	10
JP4SBC50RB-X20	6	Screw-on beam clamp mount – up to 1/2" flange. Rotates 360°.	10
JP4SBC87-X20	7	Screw-on beam clamp mount – up to 3/4" flange.	10
JP4SBC87RB-X20	8	Screw-on beam clamp mount – up to 3/4" flange. Rotates 360°.	10
JP4HBC25RB-X20	9	Hammer-on beam clamp mount – 1/8" – 1/4" flange. Rotates 360°.	10
JP4HBC50RB-X20	9	Hammer-on beam clamp mount – 5/16" – 1/2" flange. Rotates 360°.	10
JP4HBC75RB-X20	9	Hammer-on beam clamp mount – 9/16" – 3/4" flange. Rotates 360°.	10
JP4CP-X20	10	C-purlin clips for straight flanges up to 1/4" thick.	10
JP4ZP-X20	11	Z-purlin clips for angled flanges up to 1/4" thick.	10
JP4UF100-X20	12	Underfloor pedestal support clip for pedestal 7/8" square or 1 1/8" – 1 3/8" in diameter.	10

J-Pro™ Extension Bracket

- Compatible with 3/4", 1 5/16", and 2" J-Pro™ products
- Allows multiple hooks to be installed utilizing one attachment point
- Includes 1/8", 1/4", and 3/8" mounting holes for various user-supplied hardware

Part Number	Description	Std. Pkg. Qty.
PCATHBA	Multi-tier bracket for J-Pro™ product line.	10



Bend appropriate tabs with flathead screwdriver to prevent intended hook from rotating once installed.

Install appropriate J-Pro™ wall-mounted hook with user-supplied hardware.



J-Pro™ Color Selection Guide

Base Part Number	Black	Red	Blue	White	Green	Orange
JP75W	-L20	-L2			-L5	-L3
JP75WP2B	-L20					
JP75CMB	-L20	-L2				
JP75DW	-L20	-L2	-L6			
JP75ZP	-L20					
JP75CP	-L20					
JP75SBC50	-L20					
JP75SBC87	-L20					
JP75SBC50RB	-L20	-L2		-L		
JP75SBC87RB	-L20					
JP75HBC25RB	-L20					
JP75HBC50RB	-L20	-L2		-L		
JP75HBC75RB	-L20					
JP75UF100	-L20					
JP131W	-L20		-L6		-L5	-L3
JP131WP2B	-L20					
JP131CMB	-L20					
JP131DW	-L20		-L6			
JP131ZP	-L20					
JP131CP	-L20					
JP131SBC50	-L20					
JP131SBC87	-L20					
JP131SBC50RB	-L20	-L2		-L		
JP131SBC87RB	-L20					
JP131HBC25RB	-L20					
JP131HBC50RB	-L20	-L2		-L		
JP131HBC75RB	-L20					
JP131UF100	-L20					
JP2W	-L20	-L2	-L6	-L	-L5	-L3
JP2WP2B	-L20					
JP2CMB	-L20	-L2				
JP2DW	-L20	-L2	-L6	-L		
JP2ZP	-L20					
JP2CP	-L20					
JP2SBC50	-L20			-L		
JP2SBC87	-L20					
JP2SBC50RB	-L20	-L2		-L		
JP2SBC87RB	-L20	-L2				
JP2HBC25RB	-L20					
JP2HBC50RB	-L20	-L2		-L		

Table continues on page H.8

J-Pro™ Color Selection Guide (continued)

Base Part Number	Black	Red	Blue	White	Green	Orange
JP2HBC75RB	-L20					
JP2UF100	-L20					
JP4W	-X20	-X2	-X6	-X		
JP4WP2B	-X20					
JP4CMB	-X20					
JP4ZP	-X20					
JP4CP	-X20					
JP4SBC50	-X20			-X		
JP4SBC87	-X20					
JP4SBC50RB	-X20	-X2		-X		
JP4SBC87RB	-X20					
JP4HBC25RB	-X20					
JP4HBC50RB	-X20	-X2		-X		
JP4HBC75RB	-X20					
JP4UF100	-X20					

J-Mod® Series Referenced Images

- UL listed for use in plenum or air handling spaces (such as ceiling voids and underfloor areas) per NEC Article 300.22 (C) and (D) (reference pages N.2 – N.4 for details)
- Complete horizontal and vertical 1" bend radius control



Image 1



Image 2



Image 3



Image 4



Image 5



Image 6



Image 7



Image 8



Image 9



Image 10



Image 11

J-Mod® Series Installation Instructions

Align snap lock attachment of J-hook with holes in chosen bracket and snap J-hook into place.



Align chaining bracket under the assembly.



Slide chaining bracket between J-hook and the metal bracket until it snaps.



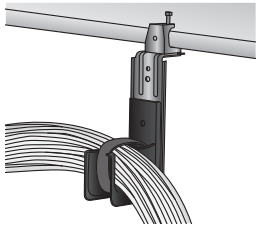
Pull down to fully engage.



Attach J-hooks as explained in first-level installation above.



Final assembly is a second-level installation consisting of one threaded rod bracket, one chaining bracket, and two J-hooks for clarity.



J-Mod® Series

- Bundle capacity: 2"
- Cable capacity: Category 6A (30), Category 6A (SD) (46), Category 6 (46), Category 5e (55)

Part Number	Image No.	Description	Std. Pkg. Qty.
JMJH2W-X20	1	J-hook for wall mount applications only; two 1/4" mounting holes for user supplied screws.	10
JMJH2-X20	2	J-hook for use with J-Mod® brackets.	10
JMCB-X	3	Chaining bracket to extend existing J-Mod® capacity; for use with single-level mounting brackets; three levels maximum.	10
JMCMB25-1-X	4	Single-level ceiling mount bracket with one 1/4" mounting hole.	10
JMCMB25-3-X	5	Three-level ceiling mount bracket with one 1/4" mounting hole.	10
JMDWB-1-X	6	Single-level drop wire bracket that attaches to #12 wire or 1/4" threaded rod.	10
JMDWB-3-X	7	Three-level drop wire bracket that attaches to #12 wire or 1/4" threaded rod.	10
JMTRB38-1-X	8	Single-level threaded rod bracket; accepts 1/4" – 3/8" threaded rod.	10
JMTRB38-3-X	9	Three-level threaded rod bracket; accepts 1/4" – 3/8" threaded rod.	10
JMSBCB87-1-X	10	Single-level screw-on beam clamp bracket for use with flanges up to 3/4" thick.	10
JMSBCB87-3-X	11	Three-level screw-on beam clamp bracket for use with flanges up to 3/4" thick.	10

Hook and Loop Cable Ties



Image 1

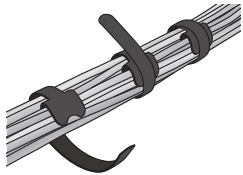


Image 2

- Soft, premium material is safe for use on high-performance communication cable
- UL listed for use in plenum or air handling spaces (such as ceiling voids and underfloor areas) per NEC Article 300.22 (C) and (D) (reference pages N.2 – N.4 for details)
- Material flammability rating: UL 94V-2
- Adjustable, releasable, and re-useable multiple times; ideal for moves, adds, and changes



Part Number	Image No.	Length (In.)	Width (In.)	Max. Bundle Dia. (In.)	Color	Std. Pkg. Qty.
HLTP2I-X12	1	8.00	0.50	1.91	Maroon	10
HLTP3I-X12	1	12.00	0.50	3.18	Maroon	10
HLTP2I-X0	1	8.00	0.50	1.91	Black	10
HLTP3I-X0	1	12.00	0.50	3.18	Black	10
HLSP1.5S-X12	2	6.00	0.75	1.50	Maroon	10
HLSP3S-X12	2	12.00	0.75	3.20	Maroon	10
HLSP5S-X12	2	18.00	0.75	5.00	Maroon	10
HLSP1.5S-X0	2	6.00	0.75	1.50	Black	10
HLSP3S-X0	2	12.00	0.75	3.20	Black	10
HLSP5S-X0	2	18.00	0.75	5.00	Black	10

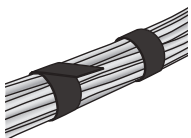


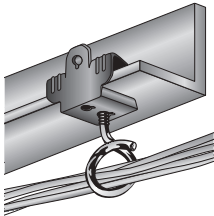
Contractor Grade Hook and Loop Cable Ties



- Strong, low-profile, flexible material that is safe to use on high-performance cabling
- Cost-effective for general bundling
- Color: Black

Part Number	Length (Feet)	Width (In.)	Max. Bundle Dia. (In.)	Std. Pkg. Qty.
TTS-35R3-0	35.00	0.75	Various	1 pkg. of 3 rolls
TTS-35RX0	35.00	0.75	Various	1 pkg. of 10 rolls
TTS-75R0	75.00	0.75	Various	1 pkg. of 10 rolls



Bridle Rings Referenced Images**Image 1****Image 2****Image 3****Image 4****Image 5**

Bridle Rings

- Suitable for low-voltage cabling
- Not suitable for high-performance communication cabling
- Variety of mounting options available to support specific application requirements



Part Number	Image No.	Description	Std. Pkg. Qty.
BR-50-10-24	1	1/2" capacity – mounts with 10-24 threads.	100
BR-75-10-24	1	3/4" capacity – mounts with 10-24 threads.	100
BR-1.25-10-24	1	1 1/4" capacity – mounts with 10-24 threads.	100
BR-2.0-10-24	1	2" capacity – mounts with 10-24 threads.	100
BR-1.25-1/4-20	1	1 1/4" capacity – mounts with 1/4"-20 threads.	100
BR-2.0-1/4-20	1	2" capacity – mounts with 1/4"-20 threads.	100
BR-4.0-1/4-20	1	4" capacity – mounts with 1/4"-20 threads.	50
BR-1.25-14WS	2	1 1/4" capacity – mounts with #14 wood screw thread.	100
BR-2.0-14WS	2	2" capacity – mounts with #14 wood screw thread.	100
BR-1.5-PAF	3	1 1/2" capacity – mounts with powder actuated fastener.	50
BR-2.0-PAF	3	2" capacity – mounts with powder actuated fastener.	50
BR-1.5-SN	4	1 1/2" capacity – mounts with screws, nails, or other user supplied fasteners.	100
BR-2.0-SN	4	2" capacity – mounts with screws, nails, or other user supplied fasteners.	100
BR-1.5-TW	5	1 1/2" capacity – mounts with toggle screw.	25
BR-2.0-TW	5	2" capacity – mounts with toggle screw.	25

Bridle Rings with Saddles

Image 1

- Plastic saddles allow bridle rings to be used for communication cable
- Suitable for use in air handling spaces
- Available pre-installed or can be ordered separately to be installed by the user



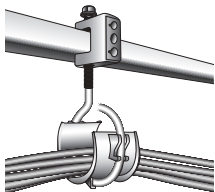
Image 2



Image 3



Part Number	Image No.	Description	Std. Pkg. Qty.
BR-1.5-1/4-20S	1	Bridle ring with saddle – 1.5" capacity – mounts with 1/4-20 threads.	50
BR-2.0-1/4-20S	1	Bridle ring with saddle – 2" capacity – mounts with 1/4-20 threads.	50
BR-4.0-1/4-20S	1	Bridle ring with saddle – 4" capacity – mounts with 1/4-20 threads.	50
BR-1.5-14WSS	2	Bridle ring with saddle – 1.5" capacity – mounts with #14 wood screw threads.	50
BR-2.0-14WSS	2	Bridle ring with saddle – 2" capacity – mounts with #14 wood screw threads.	50
BRS-1.5	3	Saddle only for 1.5" – diameter bridle ring.	100
BRS-2.0	3	Saddle only for 2" – diameter bridle ring.	100



Low-Voltage Mounting Brackets

Mount with
self-tapping screws
found on page G.18!



Image 1

- Choose design styles for new or retrofit installations
- Available in both single and double gang configurations
- Manufactured from galvanized steel materials



Image 2



Image 3

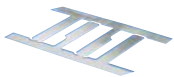


Image 4



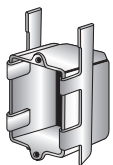
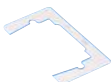
Part Number	Image No.	Description	Std. Pkg. Qty.
LV-S-1G	1	Single gang, low-voltage mounting bracket for new installations.	25
LV-S-2G	2	Double gang, low-voltage mounting bracket for new installations.	25
LV-W-1G	3	Single gang, low-voltage mounting bracket for retrofit installations; suitable for wall material thicknesses for 1/2" – 1 1/2".	100
LV-W-2G	4	Double gang, low-voltage mounting bracket for retrofit installations; suitable for wall material thicknesses for 1/2" – 1 1/2".	50



Old Work Box Mount

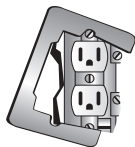
- Prevents electrical box from pulling away from dry wall
- Supports box to dry wall to prevent mounting directly to stud
- Allows quick installation with no tools required
- Manufactured from pre-galvanized steel

Part Number	Description	Std. Pkg. Qty.
PDSI2A	Secures electrical box to dry wall.	100

**Wiring Device Retainer**

- Provides stability and prevents broken cover plates
- Manufactured from pre-galvanized steel

Part Number	Description	Std. Pkg. Qty.
PRLC	Mounts standard outlet or switch in oversized openings.	100



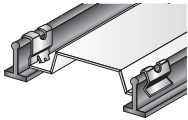
Troffer Fastener Clip



- Positive clip-on support for troffers/lay-in fixtures
- Fits round or rectangular head T-bars
- Complies with NEC Article 410.36 requirements (reference pages N.11 for details)
- For upturned or straight lip fixtures



Part Number	Description	Std. Pkg. Qty.
P515A	T-bar clip for troffers.	100

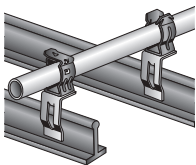


T-Bar Clip



- Supports outlet boxes above acoustical T-bar
- Top-mounted applications
- Used in conjunction with T-bar clip top-mount assemblies to eliminate the need for offset bending conduit
- Meets NEC Article 300.11 requirements (reference page N.2 for details)

Part Number	Description	Std. Pkg. Qty.
PATA4I	T-bar clip with 1/4-20 mounting hole.	100

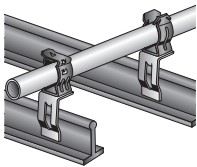


T-Bar Clip Top-Mount Assemblies**Image 1****Image 2**

- For supporting conduit above acoustical T-bar
- Top-mounted applications
- Used in conjunction with T-bar clips mounted to electrical boxes to eliminate the need for offset bending conduit
- Meet NEC Article 300.11 requirements (reference page N.2 for details)

Part Number	Image No.	Fits EMT (In.)	Fits Rigid/IMC (In.)	Std. Pkg. Qty.
P8PATA	1	1/2	—	100
P12PATA	1	3/4	1/2	100
P16PATA	1	1	3/4	100
P6MATA	2	3/8*	3/8	100
P812MATA	2	1/2 – 3/4	1/2 – 3/4	100
P16MATA	2	1	1	100

*Or 14-2 through 12-3 MC/AC cable.



T-Bar Clip Side-Mount Assemblies



Image 1

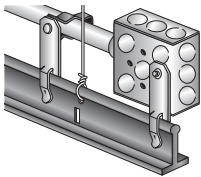


Image 2

- Support conduit above acoustical T-bar in side-mounted applications
- Used in conjunction with T-bar clips mounted to electrical boxes to eliminate the need for offset bending conduit
- Meets NEC Article 300.11 requirements (reference page N.2 for details)

Part Number	Image No.	Fits EMT (In.)	Fits Rigid/IMC (In.)	Std. Pkg. Qty.
P8PATS	1	1/2	—	100
P12PATS	1	3/4	1/2	100
P16PATS	1	1	3/4	100
P6MATS	2	3/8*	3/8	100
P812MATS	2	1/2 – 3/4	1/2 – 3/4	100
P16MATS	2	1	1	100

*Or 14-2 through 12-3 MC/AC cable.

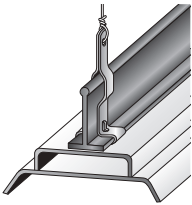


T-Bar Drop Wire Clip

- Provides a means to support fixtures from building structure instead of T-bar
- Includes 5/8" stud and wing nut washer
- Accommodates 1" T-bar
- Manufactured from pre-galvanized materials

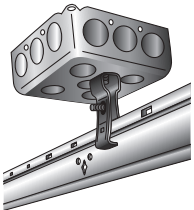


Part Number	Description	Static Load Rating (Lbs.)	Std. Pkg. Qty.
PIDS	T-bar drop wire clip for use with 1" T-bar.	65	50

**T-Bar Fastener**

- Provides method of attaching conduit and electrical boxes above T-bar
- Allows secure screw attachment to T-bar
- Eliminates offset bend in conduit

Part Number	Description	Std. Pkg. Qty.
P4ACS	Conduit and box support for T-bar with 1/4-20 threaded impression.	100



Box to T-Bar Fasteners



Image 1

- Accommodate 24" T-bar span
- Non-adjustable version is suitable for flush or offset mount
- Adjustable version provides for 8" adjustments allowing the installation of double deep boxes, speaker cases, and emergency light fixtures above T-bar



Image 2



Image 3



Image 4

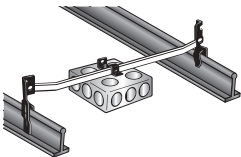


Image 5

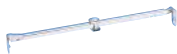


Part Number	Image No.	Description	Std. Pkg. Qty.
P512	1	Box to T-bar fastener for flush or 3/4" offset mount.	50
P512A	2	Box to T-bar fastener allows up to 8" of height adjustment.	25
PBHC*	3	Additional box mounting clip with screw for P512 and P512A.	100
P512HD	4	Heavy duty box to t-bar fastener for 24" span. Includes box mounting clip.	25
P510HD	5	Additional box mounting clip for P512HD.	100

*Not UL or cUL listed.



Heavy Duty Adjustable Box Mounting Bar Hangers

**P512HDK****P512HDT**

- Box fastener adjustable for 16" – 24" ceiling joist/stud spacing
- Allow versatility in installing electrical boxes along the length of the bar
- Install quickly and easily between ceiling joists or wall studs



Part Number	Description	Std. Pkg. Qty.
P512HDK	Installs in 1/2" knockouts in bottom of electrical box.	50
P512HDT	Includes 3/4" stud to accommodate fixture stems.	50



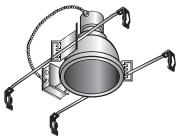
T-Bar Assembly for Lighting Support



- Accommodates fixed 24" T-bar span
- Allows for adjustable fixture position
- Fits Lightolier 5 and Calculite* series fixtures

Part Number	Description	Std. Pkg. Qty.
P520	T-bar assembly that fits Lightolier 5 and Calculite* series fixtures.	25

*Lightolier and Calculite are trademarks of the Phillips group brand.



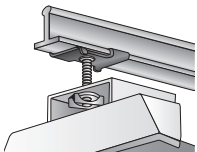
Twist-On T-Bar Hanger



- Easily twists onto T-bar to support electrical fixtures
- Accommodates T-bar 15/16" wide
- Includes 1" wing nut washer (see page L.3)

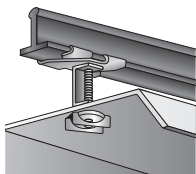


Part Number	Description	Static Load Rating (Lbs.)	Std. Pkg. Qty.
P4G16	Twist-on T-bar hanger with 1/4-20 x 5/8" long threaded stud.	50	100



T-Bar Scissor Clips**PPT16****P4G162**

Part Number	Description	Std. Pkg. Qty.
PPT16	T-bar scissor clip with 1/4-20 x 5/8" stud.	50
P4G162	T-bar scissor clip with 1/4-20 x 2" stud.	50



- Support electrical fixtures or boxes to 1" wide T-bar
- Include 1" wing nut washer (see page L.3)
- Multiple stud lengths provided
- No tools required for installation

Independent Drop Wire Clips



PEC311

- Prevent sway of dedicated drop wire
- Satisfy NEC Article 300.11 code requirements (reference page N.2 for details); consult local authority
- Yellow color provides easy identification by inspectors



PEC3114Z34

Part Number	Description	Std. Pkg. Qty.
PEC311	Independent drop wire clip.	100
PEC3114Z34	Independent drop wire clip with spring steel drop wire clip.	100

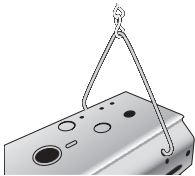


Fluorescent Light Fixture Hanger**Image 1**

- Fits most fluorescent light fixtures
- Allows quick installation with no tools required
- Provides an easy method to support an industrial class fluorescent light fixture

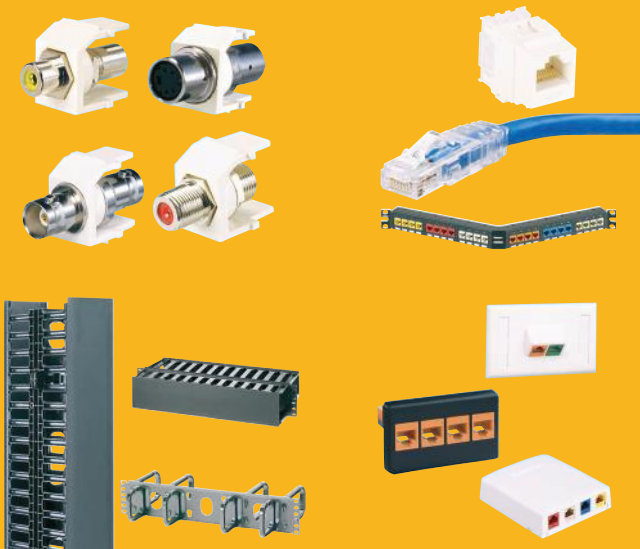
**Image 2**

Part Number	Image No.	Description	Std. Pkg. Qty.
PLFC	1	Side mount fixture clip.	100
PLFC90	2	Top mount fixture clip.	100



The Keystone Copper Cabling System provides a complete component and standards compliant cabling infrastructure solution for voice, data and video applications.

Keystone modules feature the universal “keystone” design and are compatible with a wide assortment of modular patch panels, faceplates, and surface mount boxes. When combined with complementary Panduit products, NetKey® connectivity provides solutions from the telecommunication room to the work area with proven innovation and quality.



NetKey® Category 6A, 6 and 5e Jack Modules

- Meet all industry performance standards for Category 6A, 6 and 5e
- Punchdown jack modules are 100% performance tested and individually serialized for future traceability
- Keystone punchdown jacks meet ANSI/TIA 568-C.2 and ISO 11801 component requirements
- Snap in and out of keystone openings for easy moves, adds and changes
- Universal label includes T568A and T568B wiring schemes



NK6X88MIW
NK688MIW
NKP5E88MIW

Part Number	Description	Color	Std. Pkg. Qty.	Std. Ctn. Qty.
NetKey® Category 6A UTP Jack Modules*				
NK6X88MIW	Category 6A, component compliant, 8-position, 8-wire keystone punchdown jack module.	Off White	1	50
NK6X88MIW-Q	Convenience pack of 25, Category 6A, component compliant, 8-position, 8-wire keystone punchdown jack modules.	Off White	25	250

*For standard colors other than IW (Off White), replace IW in part number with EI (Electric Ivory), IG (International Gray), WH (White), BL (Black), BU (Blue), RD (Red), YL (Yellow), GR (Green), OR (Orange) or VL (Violet).

NetKey® Category 6A, 6 and 5e Jack Modules (continued)



NK688MIW
NKP5E88MIW

Part Number	Description	Color	Std. Pkg. Qty.	Std. Ctn. Qty.
NetKey® Category 6 UTP Jack Modules				
NK688MIW	Category 6, component compliant, 8-position, 8-wire, keystone punchdown jack module.	Off White	1	50
NK688MIW-Q	Convenience pack of 25, Category 6, component compliant, 8-position, 8-wire, keystone punchdown jack modules.	Off White	25	250
NetKey® Category 5e UTP Jack Modules*				
NKP5E88MIW	Category 5e, component compliant, 8-position, 8-wire, keystone punchdown jack module.	Off White	1	50
NKP5E88MIW-Q	Convenience pack of 25, Category 5e, component compliant, 8-position, 8-wire, keystone punchdown jack modules.	Off White	25	250

*For standard colors other than IW (Off White), replace IW in part number with EI (Electric Ivory), IG (International Gray), WH (White), BL (Black), BU (Blue), RD (Red), YL (Yellow), GR (Green), OR (Orange) or VL (Violet).

NetKey® Copper UTP Patch Cords

- Meets all industry performance standards for Category 6A, 6 and 5e
- 100% performance tested
- Available in a variety of colors and lengths for design flexibility



NK6APC^*
NK6PC^*Y



NK5EPC^*Y

Part Number	Description	Std. Pkg. Qty.	Std. Ctn. Qty.
Category 6A UTP Patch Cord			
NK6APC^*	Category 6A, UTP patch cord with modular plugs on each end.	1	10
Category 6 UTP Patch Cord			
NK6PC^*Y	Category 6, UTP patch cord with modular plugs on each end.	1	10
Category 6 UTP Patch Cord			
NK5EPC^*Y	Category 5e, UTP patch cord with modular plugs on each end.	1	10

^Available in 3, 5, 7, 10, 14 and 20-foot lengths.

*For standard colors other than Off White, add suffix BU (Blue), RD (Red), YL (Yellow) or GR (Green) before Y in the part number. For example, the part number of a blue, Category 6, 5-foot patch cord is NK6PC5BUY.

NetKey® Keystone Patch Panels

- Mounts to standard ANSI/TIA 19" racks
- Punchdown patch panels meet all industry performance standards for Category 6A, 6, and 5e
- Modular patch panels accept all NetKey® Modules
- Optional angled versions available for high density installations
- Optional strain relief bars assist in cable management and bend radius control
- Not compatible with Mini-Com® Jacks and Modules



NK6XPPG24Y



NKA6XPPG24Y

Part Number	Description	Std. Pkg. Qty.	Std. Ctn. Qty.
Punchdown Patch Panels - Category 6A			
NKA6XPPG24Y	Category 6A angled punchdown patch panel, 24 port, 1 RU.	1	10
NKA6XPPG48Y	Category 6A angled punchdown patch panel, 48 port, 2 RU.	1	10
NK6XPPG24Y	Category 6A punchdown patch panel, 24 port, 1 RU.	1	10
NK6XPPG48Y	Category 6A punchdown patch panel, 48 port, 2 RU.	1	10

*Punchdown patch panels are color-coded for T568A and T568B wiring schemes.

NetKey® Keystone Patch Panels (continued)



NK6PPG12WY
NK5EPPG12WY



NKFP12W

Part Number	Description	Std. Pkg. Qty.	Std. Ctn. Qty.
Punchdown Patch Panels - Category 6			
NK6PPG12WY	Category 6, 12-port punchdown patch panel. Mounts to wall with standard 89D bracket (WB89D).	1	10
NKA6PPG24Y	Category 6, 24-port, angled punchdown patch panel, 1 RU.	1	10
NKA6PPG48Y	Category 6, 48-port, angled punchdown patch panel, 2 RU.	1	10
NK6PPG24Y	Category 6, 24-port, punchdown patch panel, 1 RU.	1	10
NK6PPG48Y	Category 6, 48-port, punchdown patch panel, 2 RU.	1	10
NK6PPG48Y	Category 6, 48-port, punchdown patch panel, 2 RU.	1	10
Punchdown Patch Panels - Category 5e			
NK5EPPG12WY	Category 5e, 12-port punchdown patch panel. Mounts to wall with standard 89D bracket (WB89D).	1	10
NKA5EPPG24Y	Category 5e, 24-port, angled punchdown patch panel, 1 RU.	1	10
NKA5EPPG48Y	Category 5e, 48-port, angled punchdown patch panel, 2 RU.	1	10
NK5EPPG24Y	Category 5e, 24-port, punchdown patch panel, 1 RU.	1	10
NK5EPPG48Y	Category 5e, 48-port, punchdown patch panel, 2 RU.	1	10

*Punchdown patch panels are color-coded for T568A and T568B wiring schemes.

NetKey® Keystone Patch Panels (continued)



NKFP24Y



NKPPA48FMY



NKFP48Y

Part Number	Description	Std. Pkg. Qty.	Std. Ctn. Qty.
Modular Patch Panels			
NKFP12W	12-port modular patch panel with front removable faceplate. Mounts to wall with standard 89D bracket (WB89D).	1	10
NKFP24Y	24-port modular patch panel with front removable faceplate, 1 RU.	1	10
NKFP48Y	48-port modular patch panel with front removable faceplate, 2 RU.	1	10
NKPPA24FMY	24-port flush mount angled modular patch panel, 1 RU.	1	10
NKPPA48FMY	48-port flush mount angled modular patch panel, 2 RU.	1	10
NKPP24FMY	24-port flush mount modular patch panel, 1 RU.	1	10
NKPP48FMY	48-port flush mount modular patch panel, 2 RU.	1	10
NK6XPPG48Y	Category 6A punchdown patch panel, 48 port, 2 RU.	1	10

*Punchdown patch panels are color-coded for T568A and T568B wiring schemes.

NetKey® Keystone Patch Panels (continued)



WB89D



SRB19BLY



SRBM19BLY

Part Number	Description	Std. Pkg. Qty.	Std. Ctn. Qty.
Wall Mount Bracket			
WB89D	Wall mount bracket. Ideal for use with 12-port punchdown or modular patch panels.	1	10
Strain Relief Bars			
SRB19BLY	Strain relief bar extends 2" from standard 19" rack for additional cable support.	1	10
SRBM19BLY	Strain relief bar and Tak-Ty® Hook & Loop Cable Ties for additional cable support.	1	10
SRBS19BL-XY	Straight strain relief bar.	1	10

*Punchdown patch panels are color-coded for T568A and T568B wiring schemes.

NetKey® Keystone Faceplates

- Mounts to standard ANSI/TIA 19" racks
- Punchdown patch panels meet all industry performance standards for Category 6A, 6, and 5e
- Modular patch panels accept all NetKey® Modules
- Optional angled versions available for high density installations
- Optional strain relief bars assist in cable management and bend radius control
- Not compatible with Mini-Com® Jacks and Modules



NK2FNIW



NK2FIWY



NK2HSFIWY



NK4VSIWY



NKF2S

Part Number	Description	Std. Pkg. Qty.	Std. Ctn. Qty.
Flush Mount Screw-On Faceplates			
NK [^] FNIW	Single gang, flush mount vertical faceplate.	1	10
NK ^{**} FIWY	Single or double gang, flush mount vertical faceplate with labels.	1	10
NK [^] HSFIWY	Single gang, sloped, horizontal faceplate with labels.	1	10
NK4VSF	Single gang, 4-port, sloped, vertical faceplate with labels.	1	10
Stainless Steel Faceplates			
NKF ^{MS}	Single gang, stainless steel, vertical faceplate with labels.	1	10

NetKey® Snap-On Sloped Keystone Faceplates



- Accept all Panduit® NetKey® Keystone Copper Modules and Duplex Fiber Optic Modules
- Snap into raceway channel, requires no additional mounting hardware or adapters - greatly reducing installation time
- Modular patch panels accept all NetKey® Modules
- Lowest cost for moves, adds, and changes
- Tamper resistant
- Can be used with Pan-Way® Cove, TG-70, T70, Twin-70, T-45 Raceway Systems, Fast-Snap™ Outlet Boxes, and Pan-Pole™ Aluminum Outlet Poles



NK2HSRF

NK4HSRF

NK4VSRF

Part Number	Description	Color‡	Std. Pkg. Qty.	Std. Ctn. Qty.
NK2HSRFIW	Snap-On 2-position sloped horizontal faceplate accepts any Panduit® NetKey® Module. Compatible with Panduit® NetKey® Outlet Boxes, Surface Raceway Systems, and Pan-Pole™ Outlet Poles.	Off White	1	10
NK4HSRFIW	Snap-On 4-position sloped horizontal faceplate accepts any Panduit® NetKey® Module. Compatible with Panduit® NetKey® Outlet Boxes, Surface Raceway Systems, and Pan-Pole™ Outlet Poles.	Off White	1	10
NK4VSRFIW	Snap-On 4-position sloped vertical faceplate accepts any Panduit® NetKey® Module. Compatible with Panduit® NetKey® Outlet Boxes, Surface Raceway Systems, and Pan-Pole™ Outlet Poles.	Off White	1	10

Panduit® NetKey® faceplates are NOT compatible with Panduit® Mini-Com® Modules.
 ‡For other colors replace IW (Off White) with EI (Electric Ivory), IG (International Gray), or WH (White).
 For complete labeling solutions refer to www.panduit.com.

StrongHold™ Cabling System Part Numbers

NetKey® Snap-On Flush Universal Keystone Faceplates



- Wider module spacing to accept common manufacturers' keystone modules 0.900 inches wide or less
- Can be used with Pan-Way® Cove, TG-70, T70, Twin-70, T-45 Raceway Systems, Fast-Snap™ Outlet Boxes, and Pan-Pole™ Aluminum Outlet Poles



T70KW2IW

T70KW4IW

Part Number	Description	Color‡	Std. Pkg. Qty.	Std. Ctn. Qty.
T70KW2IW	Snap-On 2-position flush mount faceplate accepts any Panduit® NetKey® Module and most other manufacturers' keystone modules. Compatible with Panduit® Fast-Snap™ Outlet Boxes, Surface Raceway Systems, and Pan-Pole™ Outlet Poles.	Off White	1	10
T70KW4IW	Snap-On 4-position flush mount faceplate accepts any Panduit® NetKey® Module and most other manufacturers' keystone modules. Compatible with Panduit® Fast-Snap™ Outlet Boxes, Surface Raceway Systems, and Pan-Pole™ Outlet Poles.	Off White	1	10

Panduit® NetKey® faceplates are NOT compatible with Panduit® Mini-Com® Modules.

‡For other colors replace IW (Off White) in part number with EI (Electric Ivory), IG (International Gray), or WH (White).

For complete labeling solutions refer to www.panduit.com.

NetKey® Keystone Module Frame and Furniture Faceplates

NK2106MFIW

NK4106MFIW

NK2RMFIW

NK4RMFIW

NK4MFIW

Part Number	Description	Color‡	Std.	Std.
			Pkg.	Ctn.
			Qty.	Qty.
NK2106MFIW	Screw mount "106" duplex module frame. Accepts two NetKey® Modules.	Off White	1	10
NK4106MFIW	Screw mount "106" duplex module frame. Accepts four NetKey® Modules.	Off White	1	10
NK2RMFIW	Screw mount module frame. Accepts two NetKey® Modules. Compatible with standard NEMA outlet boxes and rectangular faceplates.	Off White	1	10
NK4RMFIW	Screw mount module frame. Accepts four NetKey® Modules. Compatible with standard NEMA outlet boxes and rectangular faceplates.	Off White	1	10
NK4MFIW	Snap on modular furniture faceplate. Accepts four NetKey® Modules.	Off White	1	10

‡For standard colors other than Off White, replace IW in part number with EI (Electric Ivory), WH (White), IG (International Gray) or BL (Black).

Keystone Phone Plates



KWPY



KWP3Y

Part Number	Description	Std. Pkg. Qty.	Std. Ctn. Qty.
KWPY	Stainless steel wall phone plate accepts one module.	1	10
KWP3Y	Stainless steel wall phone plate supplied with one Category 3 keystone leadframe module.	1	10

Wall mount faceplate kits compatible with wall mountable phones with short patch cord connections to the jack module.

NetKey® Keystone Surface Mount Boxes

- Accepts all Panduit® NetKey® Modules
- Includes mounting screws and adhesive tap
- Compatible with Panduit® LE3, SD5, and LD10 Raceway
- Not Compatible with Mini-Com® Jacks and Modules



NK2BXIW-A



NK4BXIW-A



NK6BXIW-A



CBM-X

Part Number	Description	Color‡	Std. Pkg. Qty.	Std. Ctn. Qty.
NK2106MFIW	Screw mount "106" duplex module frame. Accepts two NetKey® Modules.	Off White	1	10
NK4106MFIW	Screw mount "106" duplex module frame. Accepts four NetKey® Modules.	Off White	1	10
NK2RMFIW	Screw mount module frame. Accepts two NetKey® Modules. Compatible with standard NEMA outlet boxes and rectangular faceplates.	Off White	1	10
NK4RMFIW	Screw mount module frame. Accepts four NetKey® Modules. Compatible with standard NEMA outlet boxes and rectangular faceplates.	Off White	1	10
NK4MFIW	Snap on modular furniture faceplate. Accepts four NetKey® Modules.	Off White	1	10

‡For surface mount box standard colors other than IW (Off White), replace suffix with EI (Electric Ivory), IG (International Gray) or WH (White).

StrongHold™ Cabling System Part Numbers

NetKey® Audio/Video Modules



Part Number	Description	Color‡	Std. Pkg. Qty.	Std. Ctn. Qty.
F-Type Module				
NKFIW	Keystone module supplied with 75 ohm industry standard F-Type coax bulkhead coupler.	Off White	1	10
50 Ohm BNC Coax Module				
NKBNCFIYW	Keystone module supplied with 50 ohm industry standard coax bulkhead coupler.	Off White	1	10
HDMI Coupler				
NKHDMIW	Keystone module supplied with one HDMI 1.3 Type A female to female coupler module.	Off White	1	10
USB Coupler				
NKUSBAAIW	Keystone module supplied with one USB 2.0 female A to female A coupler module.	Off White	1	10
Blank Module				
NKBMW-X	Blank keystone module reserves space for future use.	Off White	1	10

‡For standard colors other than IW (Off White), replace IW in part number with EI (Electric Ivory), WH (White), IG (International Gray) or BL (Black). 5-Way Binding Post Module (NKBPFIWY) only available in EI (Electric Ivory) and WH (White).

Termination Tool

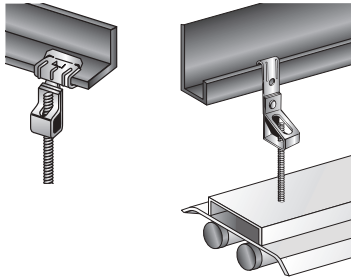
Part Number	Description	Std. Pkg. Qty.	Std. Ctn. Qty.
F-Type Module			
NKSPB	Base used to assist in terminating keystone punchdown modules.	1	10

Rod Hangers with Threaded Impressions



- Prevent the need for additional nuts
- Include 1/4" mounting hole in top for assemblies
- Static load capacity: 160 lbs.

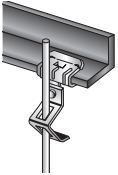
Part Number	Description	Std. Pkg. Qty.
P4TI	Accommodates 1/4-20 threaded rod.	100
P6TI	Accommodates 3/8-16 threaded rod.	100



Rod Hanger for Non-Threaded Rod

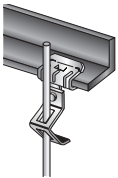
- Friction fit prevents the need for additional hardware
- Static load capacity: 160 lbs.

Part Number	Description	Std. Pkg. Qty.
P6A	3/8" non-threaded rod.	100

**Rod Hanger for Drop Wire or Non-Threaded Rod**

- Friction fit prevents the need for additional hardware
- Two windows provide most suitable fit for multiple diameter wire/rod.
- Static load capacity: 160 lbs.

Part Number	Description	Std. Pkg. Qty.
P708	Rod hanger for #8 wire or 1/4" plain rod.	100

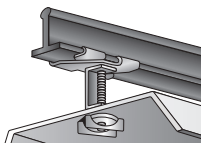


Wing Nut Washer



- Used in conjunction with products with 1/4-20 stud
- Manufactured from pre-galvanized steel
- Suitable to be installed by hand; no tools required
- Not to exceed load rating of the corresponding fastener

Part Number	Description	Std. Pkg. Qty.
P4WN	Wing nut washer fits 1/4-20 stud.	100

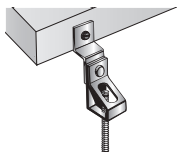


Brackets**PAO**

- Utilized for assemblies or a variety of other applications
- Prevents conduit bends to accommodate electrical boxes
- Static load capacity: 160 lbs.

**PAB**

Part Number	Description	Std. Pkg. Qty.
PAO	Offset bracket with two 1/4" non-threaded holes.	100
PAB	Right angle bracket with two 1/4" non-threaded holes.	100



Electrical Metallic Tubing (EMT)

Trade Size (In.)	Nominal Inside Dia.* (In.)	Nominal Outside Dia. (In.)	Min. Weight Per 100 Ft. w/ Couplings Attached (Lbs.)	Weight of Conduit and Conductors Per 100 Ft. (Lbs.)
0.38	0.49	0.58	23.00	36.60
0.50	0.62	0.71	28.50	50.60
0.75	0.82	0.92	43.50	84.30
1.00	1.05	1.16	64.00	130.30
1.25	1.38	1.51	95.00	212.30
1.50	1.61	1.74	110.00	269.80
2.00	2.07	2.20	140.00	401.80
2.50	2.73	2.88	205.00	579.00
3.00	3.36	3.50	250.00	826.30
3.50	3.83	4.00	325.00	1098.00
4.00	4.33	4.50	370.00	1364.00

*Per UL table NAE.3.

Intermediate Metal Conduit (IMC)

Trade Size (In.)	Nominal Inside Dia.* (In.)	Nominal Outside Dia. (In.)	Min. Weight Per 100 Ft. w/ Couplings Attached (Lbs.)	Weight of Conduit and Conductors Per 100 Ft. (Lbs.)
0.50	0.68	0.82	60.00	82.10
0.75	0.88	1.03	82.00	122.80
1.00	1.12	1.29	116.00	182.30
1.25	1.47	1.64	150.00	267.30
1.50	1.70	1.88	182.00	341.80
2.00	2.17	2.36	242.00	503.80
2.50	2.60	2.86	401.00	775.00
3.00	3.22	3.48	493.00	1069.00
3.50	3.71	3.97	573.00	1346.00
4.00	4.21	4.47	638.00	1632.00

*Per UL table NAE.3.

Rigid Steel Conduit

Trade Size (In.)	Nominal Inside Dia.* (In.)	Nominal Outside Dia. (In.)	Min. Weight Per 100 Ft. w/ Couplings Attached (Lbs.)	Weight of Conduit and Conductors Per 100 Ft. (Lbs.)
0.38	0.49	0.68	51.50	65.10
0.50	0.63	0.84	79.00	101.00
0.75	0.84	1.05	105.00	145.80
1.00	1.06	1.32	153.00	219.30
1.25	1.39	1.66	201.00	318.30
1.50	1.62	1.90	249.00	408.80
2.00	2.08	2.38	332.00	593.80
2.50	2.49	2.88	527.00	901.00
3.00	3.09	3.50	682.60	1259.00
3.50	3.57	4.00	831.00	1604.00
4.00	4.05	4.50	972.30	1967.00

*Per UL table NAE.3.

Rigid Aluminum Conduit

Trade Size (In.)	Nominal Inside Dia.* (In.)	Nominal Outside Dia. (In.)	Min. Weight Per 100 Ft. w/ Couplings Attached (Lbs.)	Weight of Conduit and Conductors Per 100 Ft. (Lbs.)
0.50	0.63	0.84	27.40	49.50
0.75	0.84	1.05	36.40	77.20
1.00	1.06	1.32	53.00	119.30
1.25	1.39	1.66	69.60	186.90
1.50	1.62	1.90	82.20	242.00
2.00	2.08	2.38	115.70	377.50
2.50	2.49	2.88	182.50	556.50
3.00	3.09	3.50	238.90	815.20
3.50	3.57	4.00	287.70	1061.00
4.00	4.05	4.50	340.00	1334.00
5.00	5.07	5.56	465.40	2028.00
6.00	6.09	6.63	612.50	2870.00

StrongHold™ Convenient Sizing Information

Electrical Non-Metallic Tubing (ENT)

Trade Nominal Size (In.)	Nominal Inside Dia.* (In.)	Nominal Outside Dia. (In.)	Min. Weight of Conduit Per 100 Ft. (Lbs.)	Weight of Conduit and Conductors Per 100 Ft. (Lbs.)
0.50	0.56	0.84	11.00	33.10
0.75	0.76	1.05	14.00	54.80
1.00	1.00	1.32	20.00	86.30
1.25	1.40	1.66	19.00	136.30
1.50	1.55	1.99	27.00	186.80
2.00	2.03	2.38	32.00	261.80

*Per UL table NAE.3.

Schedule 40 PVC Plastic Pipe

Nominal Pipe Size (In.)	Outside Dia. (In.)	Wall Thickness (In.)	Weight of Pipe Per Ft. (Lbs.)	Weight of Water Per Ft. (Lbs.)
0.13	0.41	0.07	0.04	0.02
0.25	0.54	0.09	0.07	0.04
0.38	0.68	0.09	0.10	0.08
0.50	0.84	0.11	0.15	0.1
0.75	1.05	0.11	0.20	0.20
1.00	1.32	0.13	0.30	0.40
1.25	1.66	0.14	0.40	0.60
1.50	1.90	0.15	0.50	0.90
2.00	2.38	0.15	0.60	1.40
2.50	2.88	0.20	1.00	2.10
3.00	3.50	0.22	1.30	3.20
3.50	4.00	0.23	1.60	4.30
4.00	4.50	0.24	1.90	5.50

All Threaded Rod (ATR)

Nominal Size and Thread	Root Area		Design Load SF = 5	
	In. ²	cm ²	Lbs.	kN
1/4-20	0.03	0.17	240.00	1.07
5/16-18	0.05	0.29	400.00	1.78
3/8-16	0.07	0.44	610.00	2.71

MC Cable

AWG Size	Insulated Ground Nominal Outside Dia. (In.)	Bare Ground Nominal Outside Dia. (In.)
14-2 Solid	0.45	0.43
14-3 Solid	0.48	0.44
14-4 Solid	0.51	0.49
12-2 Solid	0.50	0.47
12-3 Solid	0.53	0.50
12-4 Solid	0.57	0.56
10-2 Solid	0.56	0.52
10-3 Solid	0.60	0.55
10-4 Solid	0.65	0.62
8-2 Stranded	0.71	0.68
8-3 Stranded	0.77	0.71
8-4 Stranded	0.84	0.77
6-2 Stranded	0.80	0.76
6-3 Stranded	0.87	0.80
6-4 Stranded	0.95	0.87
4-2 Stranded	0.95	0.90
4-3 Stranded	1.04	0.95
4-4 Stranded	1.14	1.10
2-2 Stranded	1.08	1.10
2-3 Stranded	1.18	1.08
2-4 Stranded	1.30	1.18

AC Cable

Type of Armored Cable	Type of Circuit Conductors	AWG Size of Circuit Conductors	Minimum External Diameter of Armor									
			Cable with Two Circuit Conductors and No Grounding Conductor (In.)		Cable with Three Circuit Conductors and No Grounding Conductor and Cable with Two Circuit Conductors and a Grounding Conductor (In.)		Cable with Four Circuit Conductors and No Grounding Conductor and Cable with Three Circuit Conductors and a Grounding Conductor (In.)		Cable with Four Circuit Conductors and a Grounding Conductor (In.)			
			Solid	Stranded	Solid	Stranded	Solid	Stranded	Solid	Stranded		
ACTMM	THHN	14	0.43	—	0.45	—	0.49	—	0.49	—	0.52	—
		12	0.48	—	0.49	—	0.52	—	0.52	—	0.55	—
		10	0.48	—	0.50	—	0.54	—	0.54	—	0.59	—
		8	0.57	0.60	0.60	0.64	0.65	0.70	0.71	0.76	0.76	0.88
		6	—	0.70	—	0.74	—	0.81	—	0.81	—	0.88
		4	—	0.84	—	0.89	—	0.97	—	0.97	—	1.07
2	—	0.96	—	1.01	—	1.12	—	1.12	—	1.23		

Type NM – Non-Metallic Sheathed Cable

AWG Size	No. of Strands	Ground Wire Size	Approximate Outside Dia. (In.)	Approximate Weight Per 100 Ft. (Lbs.)
----------	----------------	------------------	--------------------------------	---------------------------------------

Without Ground Wire

14-2	Solid	—	0.17 x 0.37	5.30
12-2	Solid	—	0.19 x 0.40	7.00
10-2	Solid	—	0.22 x 0.45	10.10
14-3	Solid	—	0.30	8.20
12-3	Solid	—	0.33	10.90
10-3	Solid	—	0.40	15.70
8-3	7	—	0.54	27.80
6-3	7	—	0.61	42.20

With Ground Wire

14-2	Solid	14	0.17 x 0.37	6.40
12-2	Solid	12	0.19 x 0.41	9.00
10-2	Solid	10	0.22 x 0.49	13.30
8-2	7	10	0.28 x 0.61	21.50
6-2	7	10	0.32 x 0.73	31.30
14-3	Solid	14	0.32	9.30
12-3	Solid	12	0.36	12.90
10-3	Solid	10	0.44	18.70
14-4	Solid	14	0.45	11.60
12-4	Solid	12	0.49	16.10
10-4	Solid	10	0.55	23.30
8-3	7	10	0.55	30.50
6-3	7	10	0.61	45.00
4-3	7	8	0.82	66.40
2-3	7	8	0.95	93.00

StrongHold™ Convenient Sizing Information

Type THHN – Insulated Single Conductor Building Wire

Size (AWG)	Armor Outside Dia. (In.)	Approximate Weight Per 100 Ft. (Lbs.)
14	0.11	1.70
12	0.13	2.50
10	0.16	4.00
8	0.22	6.50
6	0.25	9.70
4	0.32	15.50
3	0.35	19.10
2	0.38	23.60
1	0.45	30.40
1/0	0.49	37.50

Communication Cable

Cable Type	Diameter (In.)
Category 6A	0.300
Category 6A (SD)	0.240
Category 6	0.240
Category 5e	0.225

J-Pro™ Capacity

J-Pro™ Family	Category 6A (0.300")	Category 6A (SD) (0.240")	Category 6 (0.240")	Category 5e (0.225")
JP75	5	8	8	10
JP131	15	25	25	29
JP2	30	46	46	55
JP4	115	180	180	200

Note: The above cable diameters represent the nominal Panduit cable diameter per performance level. For specific cable fill information based on specific part numbers, please contact customer service.

NFPA 70; National Electric Code; 2014 Revision

90.4 Enforcement. This Code is intended to be suitable for mandatory application by governmental bodies that exercise legal jurisdiction over electrical installations, including signaling and communications systems, and for use by insurance inspectors. The authority having jurisdiction for enforcement of the Code has the responsibility for making interpretations of the rules, for deciding on the approval of equipment and materials, and for granting the special permission contemplated in a number of the rules.

By special permission, the authority having jurisdiction may waive specific requirements in this Code or permit alternative methods where it is assured that equivalent objectives can be achieved by establishing and maintaining effective safety.

This Code may require new products, constructions, or materials that may not yet be available at the time the Code is adopted. In such event, the authority having jurisdiction may permit the use of the products, constructions, or materials that comply with the most recent previous edition of this Code adopted by the jurisdiction.

300.4 Protection Against Physical Damage.**(B) Nonmetallic-Sheathed Cables and Electrical Nonmetallic Tubing through Metal Framing Members.**

(1) Nonmetallic-Sheathed Cable. In both exposed and concealed locations where nonmetallic-sheathed cables pass through either factory- or field-punched, cut, or drilled slots or holes in metal members, the cable shall be protected by listed bushings or listed grommets covering all metal edges that are securely fastened in the opening prior to installation of the cable.

(D) Cables and Raceways Parallel to Framing Members

and Furring Strips. In both exposed and concealed locations, where a cable- or raceway-type wiring method is installed parallel to framing members, such as joists, rafters, or studs, or is installed parallel to furring strips, the cable or raceway shall be installed and supported so that the nearest outside surface of the cable or raceway is not less than 32mm (1 1/4 in.) from the nearest edge of the framing member or furring strips where nails or screws are likely to penetrate. Where this distance cannot be maintained, the cable or raceway shall be protected from penetration by nails or screws by a steel plate, sleeve, or equivalent at least 1.6mm (1/16 in.) thick.

Exception No. 1: Steel plates, sleeves, or the equivalent shall not be required to protect rigid metal conduit, intermediate metal conduit, rigid nonmetallic conduit, or electrical metallic tubing.

Exception No. 2: For concealed work in finished buildings, or finished panels for prefabricated buildings where such supporting is impracticable, it shall be permissible to fish the cables between access points.

Exception No. 3: A listed and marked steel plate less than 1.6mm (1/16 in.) thick that provides equal or better protection against nail or screw penetration shall be permitted.

**NFPA 70; National Electric Code; 2014 Revision
(continued)****300.11 Securing and Supporting.**

(A) Secured in Place. Raceways, cable assemblies, boxes, cabinets, and fittings shall be securely fastened in place. Support wires that do not provide secure support shall not be permitted as the sole support. Support wires and associated fittings that provide secure support and that are installed in addition to the ceiling grid support wires shall be permitted as the sole support. Where independent support wires are used, they shall be secured at both ends. Cables and raceways shall not be supported by ceiling grids.

(1) Fire-Rated Assemblies. Wiring located within the cavity of a fire-rated floor-ceiling or roof-ceiling assembly shall not be secured to, or supported by, the ceiling assembly, including the ceiling support wires. An independent means of secure support shall be provided and shall be permitted to be attached to the assembly. Where independent support wires are used, they shall be distinguishable by color, tagging, or other effective means from those that are part of the fire-rated design.

Exception: The ceiling support system shall be permitted to support wiring and equipment that have been tested as part of the fire-rated assembly.

Informational Note: One method of determining fire rating is testing in accordance with ANSI/ASTM E119-2012a, *Method for Fire Tests of Building Construction and Materials*.

(2) Non-Fire-Rated Assemblies. Wiring located within the cavity of a non-fire-rated floor-ceiling or roof-ceiling assembly shall not be secured to, or supported by, the ceiling assembly, including the ceiling support wires. An independent means of secure support shall be provided and shall be permitted to be attached to the assembly. Where independent support wires are used, they shall be distinguishable by color, tagging, or other effective means.

Exception: The ceiling support system shall be permitted to support branch-circuit wiring and associated equipment where installed in accordance with the ceiling system manufacturer's instructions.

300.22 Wiring in Ducts not used for Air Handling, Fabricated Ducts for Environmental Air, and other Spaces for Environmental Air (Plenums).

The provisions of this section shall apply to the installation and uses of electrical wiring and equipment in ducts used for dust, loose stock, or vapor removal; ducts specifically fabricated for environmental air; and other spaces used for environmental air (plenums).

Informational Note: See Article 424, Part VI, for duct heaters.

(A) Ducts for Dust, Loose Stock, or Vapor Removal. No wiring systems of any type shall be installed in ducts used to transport dust, loose stock, or flammable vapors. No wiring system of any type shall be installed in any duct, or shaft containing only such ducts, used for vapor removal or for ventilation of commercial-type cooking equipment.

**NFPA 70; National Electric Code; 2014 Revision
(continued)**

(B) Ducts Specifically Fabricated for Environmental Air.

Equipment, devices and the wiring methods specified in this section shall be permitted within such ducts only if necessary for the direct action upon, or sensing of, the contained air. Where equipment or devices are installed and illumination is necessary to facilitate maintenance and repair, enclosed gasketed-type luminaires shall be permitted.

Only wiring methods consisting of Type MI cable without an overall nonmetallic covering, Type MC cable employing a smooth or corrugated impervious metal sheath without an overall nonmetallic covering, electrical metallic tubing, flexible metallic tubing, intermediate metal conduit, or rigid metal conduit without an overall nonmetallic covering shall be installed in ducts specifically fabricated to transport environmental air. Flexible metal conduit shall be permitted, in lengths not to exceed 1.2m (4 ft.), to connect physically adjustable equipment and devices permitted to be in these fabricated ducts. The connectors used with flexible metal conduit shall effectively close any openings in the connection.

C) Other Spaces Used for Environmental Air (Plenums).

This section shall apply to spaces not specifically fabricated for environmental air-handling purposes but used for air-handling purposes as a plenum. This section shall not apply to habitable rooms or areas of buildings, the prime purpose of which is not air handling.

Informational Note No. 1: The space over a hung ceiling used for environmental air-handling purposes is an example of the type of other space to which this section applies.

Informational Note No. 2: The phrase “Other Spaces Used for Environmental Air (Plenum)” as used in this section correlates with the use of the term “plenum” in NFPA 90A-2012, *Standard for the Installation of Air-Conditioning and Ventilating Systems*, and other mechanical codes where the plenum is used for return air purposes, as well as some other air-handling spaces.

Exception: This section shall not apply to the joist or stud spaces of dwelling units where the wiring passes through such spaces perpendicular to the long dimension of such spaces.

(1) Wiring Methods. The wiring methods for such other space shall be limited to totally enclosed, nonventilated, insulated busway having no provisions for plug-in connections, Type MI cable without an overall nonmetallic covering, Type MC cable without an overall nonmetallic covering, Type AC cable, or other factory-assembled multiconductor control or power cable that is specifically listed for use within an air-handling space, or listed prefabricated cable assemblies of metallic manufactured wiring systems without nonmetallic sheath. Other types of cables, conductors, and raceways shall be permitted to be installed in electrical metallic tubing, flexible metallic tubing, intermediate metal conduit, rigid metal conduit without an overall nonmetallic covering, flexible metal conduit, or, where accessible, surface metal raceway or metal wireway with metal covers. Nonmetallic

**NFPA 70; National Electric Code; 2014 Revision
(continued)**

cable ties and other nonmetallic cable accessories used to secure and support cables shall be listed as having low smoke and heat release properties.

Informational Note: One method to determine low smoke and heat release properties is that the nonmetallic cable ties and other nonmetallic cable accessories exhibit a maximum peak optical density of 0.50 or less, an average optical density of 0.15 or less, and a peak heat release rate of 100kW or less when tested in accordance with ANSI/UL 2043-2008, *Fire Test for Heat and Visible Smoke Release for Discrete Products and Their Accessories Installed in Air-Handling Spaces*.

2) Cable Tray Systems. The provisions in (a) or (b) shall apply to the use of metallic cable tray systems in other spaces used for environmental air (plenums), where accessible, as follows:

(a) *Metal Cable Tray Systems.* Metal cable tray systems shall be permitted to support the wiring methods in 300.22 (C)(1).

(b) *Solid Side and Bottom Metal Cable Tray Systems.*

Solid side and bottom metal cable tray systems with solid metal covers shall be permitted to enclose wiring methods and cables, not already covered in 300.22 (C)(1), in accordance with 392.10 (A) and (B).

(3) Equipment. Electrical equipment with a metal enclosure, or electrical equipment with a nonmetallic enclosure listed for use within an air-handling space and having adequate fire-resistant and low-smoke-producing characteristics, and associated wiring material suitable for the ambient temperature shall be permitted to be installed in such other space unless prohibited elsewhere in this Code.

Informational Note: One method of defining adequate fire-resistant and low-smoke producing characteristics for electrical equipment with a nonmetallic enclosure is in ANSI/UL 2043-2008, *Fire Test for Heat and Visible Smoke Release for Discrete Products and Their Accessories Installed in Air-Handling Spaces*.

Exception: Integral fan systems shall be permitted where specifically identified for use within an air-handling space.

(D) Information Technology Equipment. Electrical wiring in air-handling areas beneath raised floors for information technology equipment shall be permitted in accordance with Article 645.

310.15 Ampacities for Conductors Rated 0–2000 Volts.**(B) Tables...****(3) Adjustment Factors.**

(a) *More Than Three Current-Carrying Conductors.* Where the number of current-carrying conductors in a raceway or cable exceeds three, or where single conductors or multiconductor cables are installed without maintaining spacing for a continuous length longer than 600mm (24 in.) and are not installed in raceways, the allowable ampacity of each conductor shall be reduced as shown in Table 310.15 (B)(3)(a). Each current-carrying conductor of a paralleled set of conductors shall be counted as a current-carrying conductor.

**NFPA 70; National Electric Code; 2014 Revision
(continued)**

Where conductors of different systems, as provided in 300.3, are installed in a common raceway or cable, the adjustment factors shown in Table 310.15 (B)(3)(a) shall apply only to the number of power and lighting conductors (Articles 210, 215, 220, and 230). Informational Note No. 1: See Annex B, for adjustment factors for more than three current-carrying conductors in a raceway or cable with load diversity.

Informational Note No. 2: See 366.23 (A) for adjustment factors for conductors in sheet metal auxiliary gutters and 376.22 (B) for adjustment factors for conductors in metal wireways.

(4) Adjustment factors shall not apply to Type AC cable or to Type MC cable under the following conditions:

- a. The cables do not have an overall outer jacket.
- b. Each cable has not more than three current-carrying conductors.
- c. The conductors are 12 AWG copper.
- d. Not more than 20 current-carrying conductors are installed without maintaining spacing, are stacked, or are supported on “bridle rings.”

(5) An adjustment factor of 60 percent shall be applied to Type AC cable or Type MC cable under the following conditions:

- a. The cables do not have an overall outer jacket.
- b. The number of current carrying conductors exceeds 20.
- c. The cables are stacked or bundled longer than 600mm (24 in.) without spacing being maintained.

314.23 Supports. Enclosures within the scope of this article shall be supported in accordance with one or more of the provisions in 314.23 (A) through (H).

(C) Mounting in Finished Surfaces. An enclosure mounted in a finished surface shall be rigidly secured thereto by clamps, anchors, or fittings identified for the application.

(D) Suspended Ceilings. An enclosure mounted to structural or supporting elements of a suspended ceiling shall be not more than 1650cm³ (100 in.³) in size and shall be securely fastened in place in accordance with either (D)(1) or (D)(2).

(1) Framing Members. An enclosure shall be fastened to the framing members by mechanical means such as bolts, screws, or rivets, or by the use of clips or other securing means identified for use with the type of ceiling framing member(s) and enclosure(s) employed. The framing members shall be supported in an approved manner and securely fastened to each other and to the building structure.

2) Support Wires. The installation shall comply with the provisions of 300.11 (A). The enclosure shall be secured, using identified methods, to ceiling support wire(s), including any additional support wire(s) installed for ceiling support. Support wire(s) used for enclosure support shall be fastened at each end so as to be taut within the ceiling cavity.

(E) Raceway Supported Enclosure, without Devices, Luminaires, or Lampholders. An enclosure that does not contain a device(s), other than splicing devices, or supports a luminaire(s),

**NFPA 70; National Electric Code; 2014 Revision
(continued)**

a lampholder, or other equipment and is supported by entering raceways shall not exceed 1650cm³ (100 in.³) in size. It shall have threaded entries or identified hubs. It shall be supported by two or more conduits threaded wrenchtight into the enclosure or hubs. Each conduit shall be secured within 900mm (3 ft.) of the enclosure, or within 450mm (18 in.) of the enclosure if all conduit entries are on the same side.

Exception: The following wiring methods shall be permitted to support a conduit body of any size, including a conduit body constructed with only one conduit entry, provided that the trade size of the conduit body is not larger than the largest trade size of the conduit or tubing:

- (1) Intermediate metal conduit, Type IMC
- (2) Rigid metal conduit, Type RMC
- (3) Rigid polyvinyl chloride conduit, Type PVC
- (4) Reinforced thermosetting resin conduit, Type RTRC
- (5) Electrical metallic tubing, Type EMT

(F) Raceway-Supported Enclosures, with Devices, Luminaires, or Lampholders.

An enclosure that contains a device(s), other than splicing devices, or supports a luminaire(s), a lampholder, or other equipment and is supported by entering raceways shall not exceed 1650cm³ (100 in.³) in size. It shall have threaded entries or identified hubs. It shall be supported by two or more conduits threaded wrenchtight into the enclosure or hubs. Each conduit shall be secured within 450mm (18 in.) of the enclosure.

Exception No. 1: Rigid metal or intermediate metal conduit shall be permitted to support a conduit body of any size, including a conduit body constructed with only one conduit entry, provided the trade size of the conduit body is not larger than the largest trade size of the conduit.

Exception No. 2: An unbroken length(s) of rigid or intermediate metal conduit shall be permitted to support a box used for luminaire or lampholder support, or to support a wiring enclosure that is an integral part of a luminaire and used in lieu of a box in accordance with 300.15 (B), where all of the following conditions are met:

- (a) *The conduit is securely fastened at a point so that the length of conduit beyond the last point of conduit support does not exceed 900mm (3 ft.).*
- (b) *The unbroken conduit length before the last point of conduit support is 300mm (12 in.) or greater, and that portion of the conduit is securely fastened at some point not less than 300mm (12 in.) from its last point of support.*
- (c) *Where accessible to unqualified persons, the luminaire or lampholder, measured to its lowest point, is at least 2.5m (8 ft.) above grade or standing area and at least 900mm (3 ft.) measured horizontally to the 2.5m (8 ft.) elevation from windows, doors, porches, fire escapes, or similar locations.*
- (d) *A luminaire supported by a single conduit does not exceed 300mm (12 in.) in any direction from the point of conduit entry.*
- (e) *The weight supported by any single conduit does not exceed*

NFPA 70; National Electric Code; 2014 Revision (continued)

9 kg (20 lbs.).

(f) At the luminaire or lampholder end, the conduit(s) is threaded wrenchtight into the box, conduit body, integral wiring enclosure, or identified hubs. Where a box or conduit body is used for support, the luminaire shall be secured directly to the box or conduit body, or through a threaded conduit nipple not over 75mm (3 in.) long.

314.27 Outlet Boxes.

(A) Boxes at Luminaire or Lampholder Outlets. Outlet boxes or fittings designed for the support of luminaires and lampholders, and installed as required by 314.23, shall be permitted to support a luminaire or lampholder.

(2) Ceiling Outlets. At every outlet used exclusively for lighting, the box shall be designed or installed so that a luminaire or lampholder may be attached. Boxes shall be required to support a luminaire weighing a minimum of 23 kg (50 lbs.). A luminaire that weighs more than 23 kg (50 lbs.) shall be supported independently of the outlet box, unless the outlet box is listed and marked on the interior of the box to indicate the maximum weight the box shall be permitted to support.

320.2 Definition.

Armored Cable, Type AC.

A fabricated assembly of insulated conductors in a flexible interlocked metallic armor. See 320.100.

320.17 Through or Parallel to Framing Members. Type AC cable shall be protected in accordance with 300.4 (A), (C), and (D) where installed through or parallel to framing members.

320.30 Securing and Supporting.

(A) General. Type AC cable shall be supported and secured by staples, cable ties, straps, hangers, or similar fittings, designed and installed so as not to damage the cable.

(B) Securing. Unless otherwise permitted, Type AC cable shall be secured within 300mm (12 in.) of every outlet box, junction box, cabinet, or fitting and at intervals not exceeding 1.4m (4 1/2 ft.) where installed on or across framing members.

(C) Supporting. Unless otherwise permitted, Type AC cable shall be supported at intervals not exceeding 1.4m (4 1/2 ft.).

Horizontal runs of Type AC cable installed in wooden or metal framing members or similar supporting means shall be considered supported where such support does not exceed 1.4m (4 1/2 ft.) intervals.

330.2 Definition.

Metal Clad Cable, Type MC. A factory assembly of one or more insulated circuit conductors with or without optical fiber members enclosed in an armor of interlocking metal tape, or a smooth or corrugated metallic sheath.

**NFPA 70; National Electric Code; 2014 Revision
(continued)****330.17 Through or Parallel to Framing Members.**

Type MC cable shall be protected in accordance with 300.4 (A), (C), and (D) where installed through or parallel to framing members.

330.30 Securing and Supporting.

(A) General. Type MC cable shall be supported and secured by staples, cable ties, straps, hangers, or similar fittings or other approved means designed and installed so as not to damage the cable.

(B) Securing. Unless otherwise provided, cables shall be secured at intervals not exceeding 1.8m (6 ft.). Cables containing four or fewer conductors sized no larger than 10 AWG shall be secured within 300mm (12 in.) of every box, cabinet, fitting, or other cable termination. In vertical installations, listed cables with ungrounded conductors 250 kcmil and larger shall be permitted to be secured at intervals not exceeding 3m (10 ft.).

(C) Supporting. Unless otherwise provided, cables shall be supported at intervals not exceeding 1.8m (6 ft.). Horizontal runs of Type MC cable installed in wooden or metal framing members or similar supporting means shall be considered supported and secured where such support does not exceed 1.8m (6 ft.) intervals.

334.2 Definitions.

Nonmetallic-Sheathed Cable. A factory assembly of two or more insulated conductors enclosed within an overall nonmetallic jacket.

334.17 Through or Parallel to Framing Members.

Types NM, NMC, or NMS cable shall be protected in accordance with 300.4 where installed through or parallel to framing members. Grommets used as required in 300.4 (B)(1) shall remain in place and be listed for the purpose of cable protection.

334.30 Securing and Supporting.

Nonmetallic-sheathed cable shall be supported and secured by staples, cable ties, straps, hangers, or similar fittings designed and installed so as not to damage the cable, at intervals not exceeding 1.4m (4 1/2 ft.) and within 300mm (12 in.) of every outlet box, junction box, cabinet, or fitting. Flat cables shall not be stapled on edge.

Sections of cable protected from physical damage by raceway shall not be required to be secured within the raceway.

(A) Horizontal Runs Through Holes and Notches.

In other than vertical runs, cables installed in accordance with 300.4 shall be considered to be supported and secured where such support does not exceed 1.4m (4 1/2 ft.) intervals and the nonmetallic-sheathed cable is securely fastened in place by an approved means within 300mm (12 in.) of each box, cabinet, conduit body, or other nonmetallic-sheathed cable termination.

Informational Note: See 314.17 (C) for support where nonmetallic boxes are used.

**NFPA 70; National Electric Code; 2014 Revision
(continued)**

342.30 Securing and Supporting.

IMC shall be installed as a complete system in accordance with 300.18 and shall be securely fastened in place and supported in accordance with 342.30 (A) and (B).

(A) Securely Fastened. IMC shall be secured in accordance with one of the following:

- (1) IMC shall be securely fastened within 900mm (3 ft.) of each outlet box, junction box, device box, cabinet, conduit body, or other conduit termination.
- (2) Where structural members do not readily permit fastening within 900mm (3 ft.), fastening shall be permitted to be increased to a distance of 1.5m (5 ft.).
- (3) Where approved, conduit shall not be required to be securely fastened within 900mm (3 ft.) of the service head for above-the-roof termination of a mast.

(B) Supports. IMC shall be supported in accordance with one of the following:

- (1) Conduit shall be supported at intervals not exceeding 3m (10 ft.).
- (2) The distance between supports for straight runs of conduit shall be permitted in accordance with Table 344.30 (B)(2), provided the conduit is made up with threaded couplings and such supports prevent transmission of stresses to termination where conduit is deflected between supports.

344.30 Securing and Supporting. RMC shall be installed as a complete system in accordance with 300.18 and shall be securely fastened in place and supported in accordance with 344.30 (A) and (B).

(A) Securely Fastened. RRMC shall be secured in accordance with one of the following:

- (1) RMC shall be securely fastened within 900mm (3 ft.) of each outlet box, junction box, device box, cabinet, conduit body, or other conduit termination.
- (2) Fastening shall be permitted to be increased to a distance of 1.5m (5 ft.) where structural members do not readily permit fastening within 900mm (3 ft.).
- (3) Where approved, conduit shall not be required to be securely fastened within 900mm (3 ft.) of the service head for above-the-roof termination of a mast.

(B) Supports. RMC shall be supported in accordance with one of the following:

- (1) Conduit shall be supported at intervals not exceeding 3m (10 ft.).
- (2) The distance between supports for straight runs of conduit shall be permitted in accordance with Table 344.30 (B)(2), provided the conduit is made up with threaded couplings and such supports prevent transmission of stresses to termination where conduit is deflected between supports.

**NFPA 70; National Electric Code; 2014 Revision
(continued)**

348.30 Securing and Supporting. FMC shall be securely fastened in place and supported in accordance with 348.30 (A) and (B).

(A) Securely Fastened. FMC shall be securely fastened in place by an approved means within 300mm (12 in.) of each box, cabinet, conduit body, or other conduit termination and shall be supported and secured at intervals not to exceed 1.4m (4 1/2 ft.) .

(B) Supports. Horizontal runs of FMC supported by openings through framing members at intervals not greater than 1.4m (4 1/2 ft.) and securely fastened within 300mm (12 in.) of termination points shall be permitted.

358.30 Securing and Supporting. EMT shall be installed as a complete system in accordance with 300.18 and shall be securely fastened in place and supported in accordance with 358.30 (A) and (B).

(A) Securely Fastened. EMT shall be securely fastened in place at least every 3m (10 ft.). In addition, each EMT run between termination points shall be securely fastened within 900mm (3 ft.) of each outlet box, junction box, device box, cabinet, conduit body, or other tubing termination.

Exception No. 1: Fastening of unbroken lengths shall be permitted to be increased to a distance of 1.5m (5 ft.) where structural members do not readily permit fastening within 900mm (3 ft.).

Exception No. 2: For concealed work in finished buildings or prefinished wall panels where such securing is impracticable, unbroken lengths (without coupling) of EMT shall be permitted to be fished.

(B) Supports. Horizontal runs of EMT supported by openings through framing members at intervals not greater than 3m (10 ft.) and securely fastened within 900mm (3 ft.) of termination points shall be permitted.

362.2 Definition.

Electrical Nonmetallic Tubing (ENT). A nonmetallic, pliable, corrugated raceway of circular cross section with integral or associated couplings, connectors, and fittings for the installation of electrical conductors. ENT is composed of a material that is resistant to moisture and chemical atmospheres and is flame retardant. A pliable raceway is a raceway that can be bent by hand with a reasonable force but without other assistance.

362.30 Securing and Supporting. ENT shall be installed as a complete system in accordance with 300.18 and shall be securely fastened in place and supported in accordance with 362.30 (A) and (B).

(A) Securely Fastened. ENT shall be securely fastened at intervals not exceeding 900mm (3 ft.). In addition, ENT shall be securely fastened in place within 900mm (3 ft.) of each outlet box, device box, junction box, cabinet, or fitting where it terminates.

Exception No. 1: Lengths not exceeding a distance of 1.8m (6 ft.)

NFPA 70; National Electric Code; 2014 Revision (continued)

from a luminaire terminal connection for tap connections to lighting luminaires shall be permitted without being secured.

Exception No. 2: Lengths not exceeding 1.8m (6 ft.) from the last point where the raceway is securely fastened for connections within an accessible ceiling to luminaire(s) or other equipment.

Exception No. 3: For concealed work in finished buildings or prefinished wall panels where such securing is impracticable, unbroken lengths (without coupling) of ENT shall be permitted to be fished.

410.36 Means of Support.

(A) Outlet Boxes. Outlet boxes or fittings installed as required by 314.23 and complying with the provisions of 314.27 (A)(1) and 314.27 (A)(2) shall be permitted to support luminaires.

(B) Suspended Ceilings. Framing members of suspended ceiling systems used to support luminaires shall be securely fastened to each other and shall be securely attached to the building structure at appropriate intervals. Luminaires shall be securely fastened to the ceiling framing member by mechanical means such as bolts, screws, or rivets. Listed clips identified for use with the type of ceiling framing member(s) and luminaire(s) shall also be permitted.

410.154 Fastening. Lighting track shall be securely mounted so that each fastening is suitable for supporting the maximum weight of luminaires that can be installed. Unless identified for supports at greater intervals, a single section 1.2m (4 ft.) or shorter in length shall have two supports, and, where installed in a continuous row, each individual section of not more than 1.2m (4 ft.) in length shall have one additional support.

590.4 General.

(J) Support. Cable assemblies and flexible cords and cables shall be supported in place at intervals that ensure that they will be protected from physical damage. Support shall be in the form of staples, cable ties, straps, or similar type fittings installed so as not to cause damage. Cable assemblies and flexible cords and cables installed as branch circuits or feeders shall not be installed on the floor or on the ground. Extension cords shall not be required to comply with 590.4(J). Vegetation shall not be used for support of overhead spans of branch circuits or feeders.

Exception: For holiday lighting in accordance with 590.3 (B), where the conductors or cables are arranged with strain relief devices, tension take-up devices, or other approved means to avoid damage from the movement of the live vegetation, trees shall be permitted to be used for support of overhead spans of branch-circuit conductors or cables.

604.7 Installation. Manufactured wiring systems shall be secured and supported in accordance with the applicable cable or conduit article for the cable or conduit type employed.

**NFPA 70; National Electric Code; 2014 Revision
(continued)**

725.24 Mechanical Execution of Work. Class 1, Class 2, and Class 3 circuits shall be installed in a neat and workmanlike manner. Cables and conductors installed exposed on the surface of ceilings and sidewalls shall be supported by the building structure in such a manner that the cable will not be damaged by normal building use. Such cables shall be supported by straps, staples, hangers, cable ties, or similar fittings designed and installed so as not to damage the cable. The installation shall also comply with 300.4 (D).

760.24 Mechanical Execution of Work.

(A) General. Fire alarm circuits shall be installed in a neat workmanlike manner. Cables and conductors installed exposed on the surface of ceilings and sidewalls shall be supported by the building structure in such a manner that the cable will not be damaged by normal building use. Such cables shall be supported by straps, staples, cable ties, hangers, or similar fittings designed and installed so as not to damage the cable. The installation shall also comply with 300.4 (D).

800.24 Mechanical Execution of Work.

Communications circuits and equipment shall be installed in a neat and workmanlike manner. Cables installed exposed on the surface of ceilings and sidewalls shall be supported by the building structure in such a manner that the cable will not be damaged by normal building use. Such cables shall be secured by hardware, including straps, staples, cable ties, hangers, or similar fittings designed and installed so as not to damage the cable. The installation shall also conform to 300.4 (D) and 300.11. Nonmetallic cable ties and other nonmetallic cable accessories used to secure and support cables in other spaces used for environmental air (plenums) shall be listed as having low smoke and heat release properties.

Informational Note No. 1: Accepted industry practices are described in ANSI/NECA/BICSI 568-2006, *Standard for Installing Commercial Building Telecommunications Cabling*;

ANSI/TIA/EIA-568-B.1-2004 — Part 1, General Requirements Commercial Building Telecommunications Cabling Standard;

ANSI/TIA-569-B-2004, *Commercial Building Standard for Telecommunications Pathways and Spaces*; ANSI/TIA-570-B, *Residential Telecommunications Infrastructure*, and other ANSI-approved installation standards.

Informational Note No. 2: See 4.3.11.2.6.5 and 4.3.11.5.5.6 of NFPA 90A-2012, *Standard for the Installation of Air-Conditioning and Ventilating Systems*, for discrete combustible components installed in accordance with 300.22 (C).

Telecommunications Pathways and Spaces; ANSI/TIA-569-C; Revision May, 2012

6.7.6 Low-Voltage Mounting Bracket

A low-voltage mounting bracket is similar to a plaster ring and may be used in place of an outlet box where permitted by code.

9.3.2 Telecommunications Pathway Separation From Lighting

Balanced twisted-pair cabling should be separated from fluorescent lamps and associated fixtures by a minimum of 125mm (5 in.).

9.4.2.1 Planning

The design shall provide a suitable means and method for supporting cables. Cable shall not be laid directly on the ceiling tile or rails.

9.4.2.2 Clearance

A minimum of 75mm (3 in.) clear vertical space shall be available above the ceiling tiles for the cabling and pathway.

9.5.4.3 Cable Management

Providing physical management for cabling placed within the access floor system lessens the chance of damage or reduced performance over the cable's life cycle. A method of physical management for major runs of cabling shall be provided. Management systems such as raceways, cable tray, and non-continuous cable supports may be used.

9.7 Non-Continuous Support

Non-continuous supports shall be located at intervals not to exceed 1.5m (5 ft.). Non-continuous supports shall be selected to accommodate the immediate and anticipated quantity, weight, and performance requirements of cables.

Steel, masonry, independent rods, independent support wires or other structural parts of the building shall be used for cable support attachment points up to the total weight for which the fastener is approved. Rods or wires that are currently employed for other functions (e.g., suspended ceiling grid support) shall not be utilized as attachment points for non-continuous supports.

NOTE: A weight of 1 kg (2.2 lbs.) (or 0.7 kg/m [0.5 lb./ft.] with spacing of support wire/rod at 1.5m [5 ft.]) is equivalent to a bundle of sixteen 4-pair 24 AWG UTP cables, including fasteners.

9.8.3.1 Conduit Termination

Conduits shall be reamed to eliminate sharp edges. Metallic conduit shall be terminated with an insulated bushing.

BICSI TDMM, 12th Edition; 2009 Revision**Page 5-1: Introduction**

Horizontal pathways include:

- Continuous pathways (e.g., conduit cable tray and cable matting) used for containment of telecommunications cabling
- Non-continuous pathways (e.g., the space between open-top cable supports [J-hooks]) through which cable is placed between physical support or containment components

Pages 5-39-5-41: Pathway and Cable Support

Every ceiling distribution system must provide proper support for cables from the telecommunications space to the work areas served. Ceiling panels, support channels (T-bars), and suspended ceiling support wires are not proper cabling supports.

Ceiling conduits, raceways, cable trays, and cabling must be suspended from or attached to the structural ceiling or walls with hardware or other installation aids specifically designed to support their weight.

The pathways must:

- Have adequate support to withstand cable pulling
- Be installed with at least 75mm (3 in.) of clear vertical space above the ceiling tiles and support channels (T-bars) to ensure accessibility

Horizontal pathways or cable should not rest directly on or be supported by:

- Ceiling panels
- Support channels (T-bars)
- Ceiling support wires
- Other components of the suspended ceiling

It is important to provide sufficient space between the suspended ceiling structure and the telecommunications pathways/cables to install, maneuver, and store ceiling tiles during service. When sufficient space is available above the pathway, up to 150mm (6 in.) should be provided between the suspended ceiling and the cabling pathways.

Where building codes permit telecommunications cable to be placed in suspended ceiling spaces without conduit, ceiling zone distribution pathways may consist of:

- Cable trays
- Open-top supports (e.g., J-hooks)

NOTE: J-hooks should be located 1.5m (5 ft.) apart at the maximum to adequately support and distribute the cable's weight. The manufacturer's specifications for cable loading should be followed.

BICSI TDMM, 12th Edition; 2009 Revision (continued)

Cable support devices that have narrow surface areas to support the cable laying horizontally inside or on top may have a detrimental effect on the transmissions performance of higher performance cabling systems.

If possible, a wider surface area should be chosen to support the cable as a precaution against potential problems. Another precaution would be to reduce the distance between the support devices.

Suspended cables must be installed with at least 75mm (3 in.) of clear vertical space above the ceiling tiles and support channels (T-bars).

For large quantities of cables (50 or more) that converge at the ER, TR, and other areas, provide cable trays or other special supports that are specifically designed to support the required cable weight and volume.

Page 5-57: Telecommunications Outlets/Connectors

Telecommunications outlet/connector boxes must be used in fire-rated wall installations and must be firestopped appropriately. Low-voltage mounting brackets (e.g., also known as mud ring, plaster ring, square-drawn cover, and box eliminator) may be used where the wall is not fire rated, and are typically used for work associated with MACs.

Telecommunications outlet/connector boxes installed in dry wall, plaster, or concrete block wall are available in an array of shapes and sizes. The size of each telecommunications outlet/connector box must be of a size that is adequate to accommodate the type and density of cabling to be installed.

Telecommunications outlet/connector boxes should not be placed back to back to serve adjacent rooms. This can compromise the effectiveness of the wall as a sound barrier and as a firestop.

J-Pro™ Cable Support System – Frequently Asked Questions

Question:

What references define how and where J-hooks are used?

Answer:

J-hooks are a horizontal pathway promoted in the BICSI® TDM manual as a means to route cable bundles (see catalog pages N.14 – N.15). Furthermore, the TIA-569-C standard promotes non-continuous supports as a means to route cable bundles as well (see catalog page N.13). According to Underwriters Laboratories Inc. (UL), the portion of the NEC® that defines the requirements of this cabling pathway is found in Section 300.22 of the NEC (see catalog pages N.2 – N.4).

Question:

What is the difference between plenum space and air handling space?

Answer:

The industry-wide confusion regarding the definition of a *plenum space* versus an *air handling space* is very common as the area above a drop ceiling is mistakenly referred to as a plenum.

Simply stated, the NEC defines a plenum area as, “a compartment or chamber to which one or more air ducts are connected and that forms part of the air distribution system.” They also reference, “the space over a hung ceiling used for environmental air-handling purposes,” and, “areas beneath raised floors for information technology equipment,” as air handling space (NEC pg. 70-144 and 70-145; see catalog pages N.2 – N.4). Often, the NEC definition of these terms differs from their common use in the industry – however, UL is compatible with the NEC terms and definitions. Therefore, the space above a hung (or drop/suspended) ceiling utilized as an air return to the HVAC unit is considered an air handling space. Additionally, the area below a raised floor used to supply conditioned air is also considered an air handling space.

Question:

Is the J-Pro™ Cable Support System approved by UL for use in air handling spaces in the United States?

Answer:

Yes, during the development of the J-Pro™ Cable Support System, Panduit coordinated testing and evaluation with UL for approval of the following statement on all the J-Pro™ Cable Support System products to reduce confusion in the market: “Suitable for use in air handling spaces in accordance with Section 300.22 (C) and (D) of the NEC....” This statement is engraved and is visible on the side or bottom of each part. According to this phrase, the J-Pro™ Cable

J-Pro™ Cable Support System – *Frequently Asked Questions (continued)*

Support System can be utilized in the area above the suspended ceiling (300.22 [C]) or below a raised floor (300.22 [D]), but it cannot be utilized within ductwork (300.22 [A] and [B]) (see catalog pages N.2 – N.4). Approval to use J-Pro™ Cable Support System above the suspended ceiling and below the raised floor was a result of completing/passing testing of the J-Pro™ Cable Support System per the UL standard UL2043, Fire Test for Visible Heat and Smoke Release for Discrete Products and their Accessories Installed in Air-Handling Spaces. This test requires product to meet certain criteria for heat release and smoke density and the values measured correlate back to the maximum flame spread and smoke index of the mechanical code. The basic standard used to investigate products in this category is ANSI/UL 1565, “Positioning Devices”. The J-Pro™ Cable Support System product line is UL listed within UL file number E136577.

Question:

Is the J-Pro™ Cable Support System approved by Underwriters’ Laboratories of Canada (ULC) for use in air handling spaces?

Answer:

Yes, for applications within Canada, the J-Pro™ Cable Support System was tested and evaluated by ULC for approval of the following statement, “In accordance with CAN/ULC S102.2 in single units or pairs. 4-foot minimum spacing, FSR = 0, SDC = 35.” This statement is engraved and visible on the side or bottom of each part. According to this phrase, the J-Pro™ Cable Support System is approved for the same air handling spaces as defined by the NEC Article 300.22 (C) and (D) (above the suspended ceiling or below a raised floor) and meets the S102.2 (Standard Method of Test for Surface Burning Characteristics of Floor Coverings, and Miscellaneous Material and Assemblies) requirements as stated in the National Building Code of Canada. The J-Pro™ Cable Support System product line is ULC listed within ULC file number R21673.

UL**File E136577****Volume 2, Section 2****Page 1****ULC****File R21673****Volume 1****Description****Product Covered:**

USL, CNL – Positioning Devices – Model JP2, JP4, JP75, JP131

General Description:

USL, CNL – Indicates that the products have been evaluated in accordance with the requirements in UL 1565 and CAN/CSA C22.2 No. 18.5-02 Standards for Positioning Devices.

These devices are a J-Pro™ J-hook, and are used in applications where zone conduit, cable trays, or ladder racks are not available or applicable.

The J-Pro™ J-hook contains a family of parts. This system has several other brackets and/or components, manufactured from a high-carbon plated steel, riveted to the JP2, JP4, JP75, and JP131 for a variety of applications.

Table 1

Family of Part Numbers	J-Pro™ Cable Support System Description
JP2	J-Pro™ J-hook

Ratings:

These devices are rated 60°C, for indoor use, suitable for use in air handling spaces in accordance with Sec. 300.22 (C) and (D) of the National Electrical Code in single units or pairs, and 30 lb. maximum load rating.

Table 3

Family of Part Numbers	J-Pro™ Cable Support System Description
JP4	J-Pro™ J-hook

Ratings:

These devices are rated 60°C, for indoor use, suitable for use in air handling spaces in accordance with Sec. 300.22 (C) and (D) of the National Electrical Code, and 100 lb. maximum load rating in single unit configuration only.

Table 4

Family of Part Numbers	J-Pro™ Cable Support System Description
JP75	J-Pro™ J-hook

Ratings:

These devices are rated 60°C, for indoor use, suitable for use in air handling spaces in accordance with Sec. 300.22 (C) and (D) of the National Electrical Code in single units or pairs, and 15 lb. maximum load rating.

Table 5

Family of Part Numbers	J-Pro™ Cable Support System Description
JP131	J-Pro™ J-hook

Ratings:

These devices are rated 60°C, for indoor use, suitable for use in air handling spaces in accordance with Sec. 300.22 (C) and (D) of the National Electrical Code in single units or pairs, and 20 lb. maximum load rating.

Scope for UL 1565 Positioning Devices

1 Scope

1:1 This standard applies to those metallic and nonmetallic devices used for positioning – which may include bundling and securing – or to a limited extent supporting cable, wire, conduit, or tubing of a wiring system in electrical installations, to reduce the risk of fire, electric shock, or injury to persons. This standard applies to, but is not limited to, cable ties, cable tie mounting blocks, cable clamps, cable and conduit clips, and non-raceway ducts.

Standard Method of Test for Surface Burning Characteristics of Floor Coverings, and Miscellaneous Material and Assemblies, CAN/ULC-S102.2-M88.

On April 1, 2004, fire tests were conducted at our ULC Toronto facilities in accordance with the Standard CAN/ULC-S102.2-03, Standard Method of Test for Surface Burning Characteristics of Floor Covering, and Miscellaneous Materials and Assemblies.



Listed in accordance with CAN/ULC-S102.2

Flame	Smoke
<u>Spread</u>	<u>Developed</u>
0	35

15KH = The control number assigned by ULC.

0 = The Flame Spread rating assigned by ULC.

35 = The Smoke Developed value assigned by ULC.

The J-Pro™ (JP2 and JP2W) products may be marked with the Flame Spread and Smoke Developed values as shown above when mounted as single units or pairs with a minimum spacing of 1220mm.

These parts may be fastened to metal clips to produce the following part number (with the same mounting requirements above), which may also bear the ULC mark:

JP2HBC25RB-	JP75DW-	JP75SBC87-	JP131CP-
JP4HBC50RB-	JP2HBC50RB-	JP75SBC50-	JP75SBC87RB-
JP131UF100-	JP4HBC75RB-	JP2HBC75RB-	JP75SBC50RB-
JP131CMB-	JP131WP2B-	JP4ZP-	JP2HBC25RB-
JP2ZP-	JP75HBC25RB-	JP131DW-	JP131SBC87-
JP4CP-	JP2HBC50RB-	JP2CP-	JP75HBC50RB-
JP131SBC50-	JP131SBC87RB-	JP4UF100-	JP2HBC75RB-
JP2UF100-	JP75HBC75RB-	JP131SBC50RB-	JP4W-
JP4WP2B-	JP2CMB-	JP2WP2B-	JP75ZP-
JP131HBC25RB-	JP4CMB-	JP4SBC87-	JP2DW-
JP2SBC87-	JP75CP-	JP131HBC50RB-	JP4SBC50-
JP4SBC87RB-	JP2SBC50-	JP2SBC87RB-	JP75UF100-
JP131HBC75RB-	JP4SBC50RB-	JP2SBC50RB-	JP75CMB-
JP75WP2B-	JP131ZP-	JP4HBC25RB-	

StrongHold™ Part Number Index**B**

BR-1.5-PAF	H.15
BR-1.5-SN	H.15
BR-1.5-TW	H.15
BR-1.25-1/4-20	H.15
BR-1.25-10-24	H.15
BR-1.25-14WS	H.15
BR-2.0-1/4-20	H.15
BR-2.0-10-24	H.15
BR-2.0-14W	H.15
BR-2.0-PAF	H.15
BR-2.0-SN	H.15
BR-2.0-TW	H.15
BR-4.0-1/4-20	H.15
BR-.50-10-24	H.15
BR-.75-10-24	H.15

C

CSM-1.25-C	G.17
------------------	------

E

E10-6FB-Q	C.3
E10-6LFB-Q	C.4
E10-6RB-Q	C.3
E10-8FB-Q	C.3
E10-8LFB-Q	C.4
E10-8RB-Q	C.3
E10-10FB-Q	C.3
E10-10LFB-Q	C.4
E10-10RB-Q	C.3
E10-14FB-Q	C.3
E10-14LFB-Q	C.4
E10-14RB-Q	C.3
E14-4RB-Q*	C.3
E14-6FB-Q*	C.3
E14-6LFB-Q*	C.4
E14-6RB-Q*	C.3
E14-8FB-Q*	C.3
E14-8LFB-Q*	C.4
E14-8RB-Q*	C.3
E14-10FB-Q*	C.3
E14-10LFB-Q*	C.4
E14-10RB-Q*	C.3
E18-4RB-Q*	C.3
E18-6FB-Q*	C.3
E18-6LFB-Q*	C.4
E18-6RB-Q*	C.3
E18-8FB-Q*	C.3
E18-8LFB-Q*	C.4
E18-8RB-Q*	C.3
E18-10FB-Q*	C.3
E18-10LFB-Q*	C.4
E18-10RB-Q*	C.3
EBNF14-4FIB-Q	C.6
EBNF14-4FIM-Q	C.6
EBNF18-4FIB-Q	C.6
EBNF18-4FIM-Q	C.6

EBV14-4B-Q	C.6
EBV14-4MB-Q	C.6
EBV18-4B-Q	C.6
EBV18-4MB-Q	C.6
ED10-250M-Q	C.5
ED14-188-Q*	C.5
ED14-250MB-Q*	C.5
ED14-250-Q*	C.5
ED18-188-Q*	C.5
ED18-250MB-Q*	C.5
ED18-250-Q*	C.5
EDNF10-250FI-Q	C.4
EDNF14-187MB-Q	C.5
EDNF14-188FIB-Q*	C.4
EDNF14-250FIB-Q*	C.4
EDNF18-187MB-Q	C.5
EDNF18-188FIB-Q*	C.4
EDNF18-250FIB-Q*	C.4
EDNF10250FIMB-Q	C.5
EDNF14250FIMB-Q*	C.5
EDNF18250FIMB-Q*	C.5
EDV10-11MB-Q	C.8
EDV10-250FIB-Q	C.5
EDV10-250M-Q	C.5
EDV10-250P-Q	C.6
EDV10-250-Q	C.5
EDV14-87MB-Q	C.8
EDV14-187MB-Q	C.5
EDV14-188B-Q*	C.5
EDV14-250B-Q*	C.5
EDV14-250FIB-Q	C.5
EDV14-250M-Q*	C.5
EDV14-250P-Q*	C.6
EDV18-87MB-Q	C.8
EDV18-187MB-Q	C.5
EDV18-188B-Q*	C.5
EDV18-250B-Q*	C.5
EDV18-250FIB-Q	C.5
EDV18-250M-Q*	C.5
EDV18-250P-Q*	C.6
EJN218-216-Q*	C.8
EJN314-412-Q	C.8
EJN418-212-Q	C.8
EQSP10-18D-Q	C.7
EQSP10-Q	C.7
EQSP14D-Q*	C.7
EQSP14-Q	C.7
EQSP18D-Q	C.7
EQSP18-Q	C.7
ES10B-Q	C.6
ES14B-Q*	C.6
ES18B-Q*	C.6
ESV6-ESV8-Q	C.7
ESV8-ESV10-Q	C.7
ESV8-ESV14-Q	C.7
ESV10BX-Q	C.6
ESV10-ESV14-Q	C.7
ESV10-ESV18-Q	C.7
ESV14BX-Q*	C.6

StrongHold™ Part Number Index

ESV14-ESV18-Q	C.7	EV18-P47B-Q*	C.7
ESV18BX-Q*	C.6		
EV6-10R-Q	C.2	H	
EV6-12R-Q	C.2	HLSP1.5S-X0	H.12
EV6-38R-Q	C.2	HLSP1.5S-X12	H.12
EV6-56R-Q	C.2	HLSP3S-X0	H.12
EV8-8R-Q	C.2	HLSP3S-X12	H.12
EV8-12R-Q	C.2	HLSP5S-X0	H.12
EV8-14R-Q	C.2	HLSP5S-X12	H.12
EV8-38R-Q	C.2	HLTP2I-X0	H.12
EV8-56R-Q	C.2	HLTP2I-X12	H.12
EV10-6FB-Q	C.3	HLTP3I-X0	H.12
EV10-6LFB-Q	C.4	HLTP3I-X12	H.12
EV10-6RB-Q	C.2	HLTT1.5S-Q20	H.13
EV10-8FB-Q	C.3		
EV10-8FNB-Q	C.4	I	
EV10-8LFB-Q	C.4	IMLT25S-C	B.4
EV10-8RB-Q	C.2	IMLT25S-C6L	B.4
EV10-10FB-Q	C.3	IMLT51H-L	B.6
EV10-10FNB-Q	C.4	IMLT51H-L6L	B.6
EV10-10LFB-Q	C.4	IMLT51S-C	B.4
EV10-10RB-Q	C.2	IMLT51S-C6L	B.4
EV10-12RB-Q	C.2	IMLT69H-L	B.6
EV10-14FB-Q	C.3	IMLT69H-L6L	B.6
EV10-14LFB-Q	C.4	IMLT69S-C	B.4
EV10-14RB-Q	C.2	IMLT69S-C6L	B.4
EV10-38RB-Q	C.2	IMLT102H-L	B.6
EV10-56FB-Q	C.3	IMLT102H-L6L	B.6
EV10-56RB-Q	C.2	IMLT102S-C	B.4
EV10-P55-Q	C.7	IMLT102S-C6L	B.4
EV14-6FB-Q*	C.3	IMLT152H-L	B.6
EV14-6FNB-Q	C.4	IMLT152H-L6L	B.6
EV14-6LFB-Q*	C.4	IMLT152S-C	B.4
EV14-6RB-Q*	C.2	IMLT152S-C6L	B.4
EV14-8FB-Q*	C.3	IMLT203H-L	B.6
EV14-8FNB-Q	C.4	IMLT203H-L6L	B.6
EV14-8LFB-Q*	C.4	IMLT203S-C	B.4
EV14-8RB-Q*	C.2	IMLT203S-C6L	B.4
EV14-10FB-Q*	C.3	IMLT254H-L	B.6
EV14-10FNB-Q	C.4	IMLT254H-L6L	B.6
EV14-10LFB-Q*	C.4	IMLT254S-C	B.4
EV14-10RB-Q*	C.2	IMLT254S-C6L	B.4
EV14-14FB-Q	C.3	IMLT304H-Q	B.6
EV14-14RB-Q*	C.2	IMLT304H-Q6L	B.6
EV14-38RB-Q	C.2	IMLT304S-Q	B.4
EV14-56RB-Q*	C.2	IMLT304S-Q6L	B.4
EV14-P47B-Q*	C.7	IMLT355H-Q	B.6
EV18-6FB-Q*	C.3	IMLT355H-Q6L	B.6
EV18-6LFB-Q*	C.4	IMLT355S-Q	B.4
EV18-6RB-Q*	C.2	IMLT355S-Q6L	B.4
EV18-8FB-Q*	C.3	IMLT380S-Q	B.4
EV18-8LFB-Q*	C.4	IMLT380S-Q6L	B.4
EV18-8RB-Q*	C.2	IMLTFC38H-C6L	B.7
EV18-10FB-Q*	C.3	IMLTFC38S-C6L	B.7
EV18-10LFB-Q*	C.4	IMLTFC51H-L6L	B.7
EV18-10RB-Q*	C.2	IMLTFC51S-C6L	B.7
EV18-14FB-Q	C.3	IMLTFC64H-C6L	B.7
EV18-14RB-Q*	C.2	IMLTFC64S-C6L	B.7
EV18-56RB-Q*	C.2		

StrongHold™ Part Number Index (continued)

IMLTFC69H-L6LB.7	JP4W-X20H.5
IMLTFC86H-C6LB.7	JP4ZP-X20H.5
IMLTFC86S-C6LB.7	JP75CMB-L20H.2
IMLTFC102H-L6LB.7	JP75CP-L20H.2
IMLTFC102S-C6LB.7	JP75DW-L20H.2
IMLTFC137H-C6LB.7	JP75HBC25RB-L20H.2
IMLTFC137S-C6LB.7	JP75HBC50RB-L20H.2
IMLTFC152H-L6LB.7	JP75HBC75RB-L20H.2
IMLTFC152S-C6LB.7	JP75SBC50-L20H.2
IMLTFC203H-L6LB.7	JP75SBC50RB-L20H.2
IMLTFC203S-C6LB.7	JP75SBC87-L20H.2
IMS9.5T35-QR6LB.10	JP75SBC87RB-L20H.2
IMS12T35-QR6LB.10	JP75UF100-L20H.2
IMS16T35-QR6LB.10	JP75W-L20H.2
IMSB E19-C6LB.10	JP75WP2B-L20H.2
IMSBL9.5-C6LB.10	JP75ZP-L20H.2
IMSBL12-C6LB.10	JP131CMB-L20H.3
IMSBL16-C6LB.10	JP131CP-L20H.3
IMSP9.5T35-QR6LB.10	JP131DW-L20H.3
IMSP12T35-QR6LB.10	JP131HBC25RBL20H.3
IMSP16T35-QR6LB.10	JP131HBC50RBL20H.3
		JP131HBC75RBL20H.3
		JP131SBC50-L20H.3
		JP131SBC50RBL20H.3
		JP131SBC87-L20H.3
		JP131SBC87RBL20H.3
		JP131UF100-L20H.3
		JP131W-L20H.3
		JP131WP2B-L20H.3
		JP131ZP-L20H.3
J		K	
JMCB-XH.11	KWP3YK.13
JMCMB25-1-XH.11	KWPYK.13
JMCMB25-3-XH.11	L	
JMDWB-1-XH.11	LV-S-1GI.1
JMDWB-3-XH.11	LV-S-2GI.1
JMJH2W-X20H.11	LV-W-1GI.1
JMJH2-X20H.11	LV-W-2GI.1
JMSBCB87-1-XH.11	M	
JMSBCB87-3-XH.11	MC/ACG.13
JMTRB38-1-XH.11	MSG-1.3-CG.16, G.18
JMTRB38-3-XH.11	MSGV-1.3-CG.16
JP2CMB-L20H.4	MSPT-1.3G.18
JP2CP-L20H.4	N	
JP2DW-L20H.4	NK2HSRFIWK.10
JP2HBC25RB-L20H.4	NK2RMFIWK.12, K.14
JP2HBC50RB-L20H.4	NK4HSRFIWK.10
JP2HBC75RB-L20H.4	NK4MFIWK.12, K.14
JP2SBC50-L20H.4	NK4RMFIWK.12, K.14
JP2SBC50RB-L20H.4	NK4VSFK.9
JP2SBC87-L20H.4	NK4VSRFIWK.10
JP2SBC87RB-L20H.4	NK5EPPG12WYK.6
JP2UF100-L20H.4		
JP2W-L20H.4		
JP2WP2B-L20H.4		
JP2ZP-L20H.4		
JP4CMB-X20H.5		
JP4CP-X20H.5		
JP4HBC25RB-X20H.5		
JP4HBC50RB-X20H.5		
JP4HBC75RB-X20H.5		
JP4SBC50RB-X20H.5		
JP4SBC50-X20H.5		
JP4SBC87RB-X20H.5		
JP4SBC87-X20H.5		
JP4UF100-X20H.5		
JP4WP2B-X20H.5		

StrongHold™ Part Number Index (continued)

NK5EPPG24Y	K.6	P6A	L.2
NK5EPPG48Y	K.6	P6A24	E.7
NK6PPG12WY	K.6	P6A58	E.7
NK6PPG24Y	K.6	P6A912	E.7
NK6PPG48Y	K.6	P6AO	F.1
NK6X88MIW	K.2, K.4	P6M	D.1
NK6X88MIW-Q	K.2	P6M24	D.4
NK6XPPG24Y	K.5	P6M24SM	D.5
NK6XPPG48Y	K.5, K.7	P6M58	D.4
NK688MIW	K.3	P6M58SM	D.5
NK688MIW-Q	K.3	P6M912	D.4
NK2106MFIW	K.12, K.14	P6M912SM	D.5
NK4106MFIW	K.12, K.14	P6MATA	J.2
NKA5EPPG24Y	K.6	P6MATS	J.3
NKA5EPPG48Y	K.6	P6MB18	D.13
NKA6PPG24Y	K.6	P6MB18A	D.13
NKA6PPG48Y	K.6	P6MF	G.5
NKA6XPPG24Y	K.5	P6TA24	E.7
NKA6XPPG48Y	K.5	P6TA58	E.7
NKBMIW-X	K.15	P6TB	F.1
NKBNCMIWY	K.15	P6TI	L.1
NKFIW	K.15	P6TIB	F.1
NK**FIWY	K.9	P6TIO	F.1
NK*FNIW	K.9	P6TO	F.1
NKFP12W	K.7	P6Z34	D.9
NKFP24Y	K.7	P8P	D.2
NKFP48Y	K.7	P8P8P	D.10
NKF^S	K.9	P8P12P	D.10
NKHDMIIW	K.15	P8P16P	D.10
NK^HSFIWY	K.9	P8P24	D.6
NKP5E88MIW	K.3	P8P24SM	D.6
NKP5E88MIW-Q	K.3	P8P58	D.6
NKPP24FMY	K.7	P8P58SM	D.6
NKPP48FMY	K.7	P8P912	D.6
NKPPA24FMY	K.7	P8P912SM	D.6
NKPPA48FMY	K.7	P8PATA	J.2
NKSPB	K.16	P8PATS	J.3
NKUSBAAIW	K.15	P8PF	G.5
Non-metallic	G.13	P12P	D.2
P		P12P12P	D.10
P4ACS	J.4	P12P16P	D.10
P4G16	J.7	P12P24	D.6
P4G162	J.8	P12P24SM	D.6
P4H24	E.2	P12P58	D.6
P4H58	E.2	P12P58SM	D.6
P4H912	E.2	P12P912	D.6
P4TI	L.1	P12P912SM	D.6
P4TI24	E.7	P12PATA	J.2
P4TI912	E.7	P12PATS	J.3
P4TIB	F.1	P12PF	G.5
P4TIO	F.1	P16M	D.1
P4WN	L.3	P16M24	D.4
P4Z34*	D.9	P16M24SM	D.5
P4Z348P	D.9	P16M58	D.4
P4Z3412P	D.9	P16M58SM	D.5
P4Z3416M	D.9	P16M912	D.4
P4Z3416P	D.9	P16M912SM	D.5
P4Z34812M	D.9	P16MATA	J.2
		P16MATS	J.3

StrongHold™ Part Number Index (continued)

P16MB18	D.14	P812MB18	D.13
P16MB18A	D.14	P812MB18A	D.13
P16MF	G.5	P812MB18S	D.14
P16P	D.1	P812MB1824	D.13
P16P16P	D.10	P812MF	G.5
P16P24	D.6	P1224TI	E.12
P16P24SM	D.6	P1226T	E.12
P16P58	D.6	P1226TI	E.12
P16P58SM	D.6	P1236M	E.11
P16P912	D.6	P1238P	E.11
P16P912SM	D.6	P1616M	D.10
P16PATA	J.2	P1620M	D.10
P16PATS	J.3	P1624M	D.10
P16PF	G.5	P3508P	G.6
P20M	D.1	P12312P	E.11
P20M24	D.4	P12316M	E.11
P20M24SM	D.5	P12316P	E.11
P20M58	D.4	P12320M	E.11
P20M58SM	D.5	P16812M	D.10
P20M912	D.4	P35012P	G.6
P20M912SM	D.5	P35016M	G.6
P24M	D.1	P35016P	G.6
P24M24	D.4	P123812M	E.11
P24M24SM	D.5	P350812M	G.6
P24M58	D.4	PAF14	E.8
P24M58SM	D.5	PAO	L.4
P24M912	D.4	PAOL8P	D.19
P24M912SM	D.5	PAOL12P	D.19
P32M	D.1	PAOL16P	D.19
P32M24	D.4	PATA4I	J.1
P32M24SM	D.5	PBC	E.1
P32M58	D.4	PBC*	E.1
P32M58SM	D.5	PBC8P	E.5
P32M912	D.4	PBC8PSM	E.5
P32M912SM	D.5	PBC12P	E.5
P122	E.9	PBC12PSM	E.5
P123	E.9	PBC16M	E.5
P166M	D.10	PBC16MSM	E.5
P304B2	G.2	PBC16P	E.5
P350	G.6	PBC16PSM	E.5
P449	D.16	PBC20M	E.5
P512	J.5	PBC20MSM	E.5
P512A	J.5	PBC24M	E.5
P512HDK	J.6	PBC24MSM	E.5
P512HDT	J.6	PBC32M	E.5
P515A	J.1	PBC32MSM	E.5
P520	J.7	PBC200	E.1
P766	G.7	PBC200CD1B	E.6
P766PMD	G.7	PBC200CD2.5B	E.6
P812M	D.1	PBC200CD2B	E.6
P812M4I**	D.1	PBC200CD3B	E.6
P812M24	D.4	PBC200CD4B	E.6
P812M24SM	D.5	PBC200CD5B	E.6
P812M58	D.4	PBC400	E.1
P812M58SM	D.5	PBC812M	E.5
P812M912	D.4	PBC812MSM	E.5
P812M912SM	D.5	PCATHBA	H.6
P812MATA	J.2	PCD0B	D.3
P812MATS	J.3	PCD1B	D.3

StrongHold™ Part Number Index

PCD2.5B	D.3	PMSS24	F.2
PCD2B	D.3	PMSS58	F.2
PCD3B	D.3	PMSS912	F.2
PCD4B	D.3	PPT16	J.8
PCD5B	D.3	PRBS16	G.9
PCD6B	D.3	PRBS24	G.9
PCD7B	D.3	PRLC	I.2
PCD8B	D.3	PSC2A	D.15
PCD9B	D.3	PSC2B	D.15
PCJ6	G.13	PSC2C	D.15
PCNB8P	D.18	PSC2D	D.15
PCNB12P	D.18	PSC2E	D.15
PCNB812M	D.18	PSC2F	D.15
PCS16	G.2	PSC2G	D.15
PCS812D	G.2	PSC4A	D.15
PDS12A	I.2	PSC4B	D.15
PEC311	J.9	PSC4C	D.15
PEC3114Z34	J.9	PSC4D	D.15
PFB6M	G.15	PSC4E	D.15
PFB8P	G.15	PSC4F	D.15
PFB12P	G.15	PSC4G	D.15
PFB812M	G.15	PSC8A	D.15
PFBS18	G.11	PSC8B	D.15
PFMBS18	G.12	PSC8C	D.15
PFXC20	G.14	PSC8D	D.15
PH4	G.1	PSC8E	D.15
PH6	G.1	PSC8F	D.15
PH23	G.1	PSC8G	D.15
PIDS	J.4	PSCH6B	D.11
PJ1A4	G.7	PSCH8B	D.11
PJ1A6	G.7	PSCH12B	D.11
PJ1A25	G.7	PSCH16B	D.11
PJ1A35	G.7	PSCH20B	D.11
PK8	D.8	PSCH24B	D.11
PK12	D.8	PSCH32B	D.11
PK16*	D.8	PSCH40B	D.11
PK20*	D.8	PSCH48B	D.11
PKX*	D.7	PSCH56B	D.11
PM24	E.3	PSCH64B	D.11
PM24S	E.3	PSCH72B	D.11
PM58	E.3	PSGB16A	G.10
PM58S	E.3	PSGB24A	G.10
PM912	E.3	PSK85I	D.12
PM912S	E.3	PSK125I	D.12
PMCS50	D.17	PSK165I	D.12
PMCS100	D.17	PSK205	D.12
PMCS101	D.17	PSK245I	D.12
PMEB1	G.1	PSK325I	D.12
PMF250	G.4	PSK405I	D.12
PMF375	G.4	PSK485I	D.12
PMF500	G.4	PSK565I	D.12
PMF625	G.4	PSK645I	D.12
PMF750	G.4	PTSGB16	G.8
PMFO	G.3	PTSGB24	G.8
PMFS	G.3	PVF14	E.8
PMSF	G.3	PVF144TI	E.10
PMSR24	F.2	PVF146T	E.10
PMSR58	F.2	PVF146TI	E.10
PMSR912	F.2	PWMX3	D.16

StrongHold™ Part Number Index (continued)

PWMX6	D.16	S17-50-C	A.4
S		S17-50-C0	A.4
S4-18-C	A.4	S17-50-M	A.4
S4-18-C0	A.4	S17-50-M0	A.4
S4-18-M	A.4	S18-120-L	A.6
S4-18-M0	A.4	S18-120-L0	A.6
S5-50-C	A.4	S21-50-C	A.4
S5-50-C0	A.4	S21-50-C0	A.4
S5-50-M	A.4	S21-50-M	A.4
S5-50-M0	A.4	S21-50-M0	A.4
S6-18-C	A.4	S21-120-C	A.6
S6-18-C0	A.4	S21-120-C0	A.6
S6-18-M	A.4	S21-120-L	A.6
S6-18-M0	A.4	S21-120-L0	A.6
S6-40-C	A.4	S24-120-L	A.6
S6-40-C0	A.4	S24-120-L0	A.6
S6-40-M	A.4	S24-120-Q	A.6
S6-40-M0	A.4	S24-120-Q0	A.6
S6-50-C	A.4	S30-120-L	A.6
S6-50-C0	A.4	S30-120-L0	A.6
S6-50-M	A.4	S30-120-X	A.6
S6-50-M0	A.4	S30-120-X0	A.6
S7-50-C	A.4	SC8-50-S10-C	A.6
S7-50-C0	A.4	SC8-50-S10-C0	A.6
S7-50-M	A.4	SC15-120-S25-L	A.6
S7-50-M0	A.4	SC15-120-S25-L0	A.6
S8-18-C	A.4	SRB19BLY	K.8
S8-18-C0	A.4	SRBM19BLY	K.8
S8-18-M	A.4	SRBS19BL-XY	K.8
S8-18-M0	A.4	T	
S8-40-C	A.4	T70KW2IW	K.11
S8-40-C0	A.4	T70KW4IW	K.11
S8-40-M	A.4	TTS-35R3-0	H.13
S8-40-M0	A.4	TTS-35RX0	H.13
S8-50-C	A.4	W	
S8-50-C0	A.4	WB89D	K.8
S8-50-M	A.4		
S8-50-M0	A.4		
S10-50-C	A.4		
S10-50-C0	A.4		
S12-40-C	A.4		
S12-40-C0	A.4		
S12-40-M	A.4		
S12-40-M0	A.4		
S12-50-C	A.4		
S12-50-C0	A.4		
S12-50-M	A.4		
S12-50-M0	A.4		
S14-120-L	A.6		
S14-120-L0	A.6		
S14-120-TL	A.6		
S14-120-TL0	A.6		
S15-40-C	A.4		
S15-40-C0	A.4		
S15-50-C	A.4		
S15-50-C0	A.4		
S15-50-M	A.4		
S15-50-M0	A.4		

**Panduit is a global leader in
cabling and communication products,
delivering end-to-end solutions in support of
demanding electrical and networking requirements.**

Panduit Catalogs

Industrial Electrical Solutions

ELCB31--SA-ENG

- **Bundle**
Cable Ties
Cable Accessories
Stainless Steel Cable Ties
and Accessories
- **Route/Protect**
Wiring Duct
Abrasion Protection
Cable Management
- **Terminate**
Terminals
Power Connectors
Grounding Connectors
- **Identification and Safety Solutions**
Labeling Systems
Labels
Pre-Printed and
Write-On Markers
Permanent Identification
Lockout/Tagout and
Safety Solutions
- **Keystone Cabling Systems**

Network and Infrastructure Solutions

NCCB93--SA-ENG

- Copper Systems
- Fiber Systems
- Faceplates, Outlet Frames
and Surface Mount
Boxes
- Keystone Cabling Systems
- Zone Cabling
- Cable Routing Systems
- Surface Raceway
- Cabinets, Racks and
Cable Management
Systems
- Power Management
- Grounding and Bonding
- Identification Products
- Cable Management
Accessories

Contractor Grade Solutions for Electrical and Networking Installations

Panduit is committed to providing our contractor partners a comprehensive portfolio of products, programs, and services to help increase job site productivity, improve back-office operations, and accelerate cash flow. Our collaborative approach addresses the greatest business challenges for the contractor community, and provides a competitive advantage in your market space.

Solutions

- Whether the solution is for electrical or networking systems, Panduit offers a unique understanding of the complexities of infrastructure construction
- We continually offer new application systems focused on meeting the ever-changing installation and maintenance needs of our customers

Programs*

- The Panduit Business Partner Program offers a variety of benefits designed to help increase effectiveness, address the business needs of customers, and grow overall profitability
- A prescriptive planning and inventory management program that provides visibility throughout all levels of the supply chain to increase service levels and keep projects on schedule

Services

- The Mobile Access Guide immediately provides information required to keep your project moving when working on-site or from most any remote location
- Extensive website with product specifications, installation guides, part drawings and more, to make your job easier
- World-class customer service and product availability keep your projects on time and within budget

STRONGHOLD™

CONTRACTOR GRADE PRODUCTS
FOR GENERAL PURPOSE APPLICATIONS

*For complete program details, go to www.panduit.com or contact Customer Service at 800.777.3300. All programs and benefits subject to terms and conditions.

STRONGHOLD™

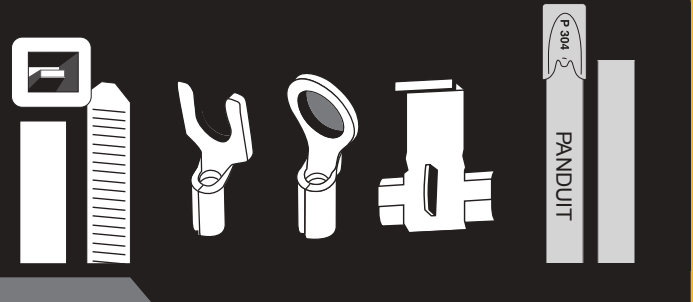
CONTRACTOR GRADE PRODUCTS
FOR GENERAL PURPOSE APPLICATIONS

STRONGHOLD™

CONTRACTOR GRADE PRODUCTS
FOR GENERAL PURPOSE APPLICATIONS

Panduit Corporate World Headquarters

Tinley Park, Illinois 60487



For more information

Visit us at www.panduit.com

Contact Customer Service by email: cs@panduit.com
or by phone: 800-777-3300

Commercial Construction Pocket Guide

© 2018 Panduit Corp.
ALL RIGHTS RESERVED
Printed in the U.S.A.
Catalog Number **CMCB02-SA-ENG**
Replaces WACB24-SA-ENG
9/2018

PANDUIT®

X-ON Electronics

Largest Supplier of Electrical and Electronic Components

Click to view similar products for [Cable Mounting & Accessories](#) category:

Click to view products by [Panduit](#) manufacturer:

Other Similar products are found below :

[582603-1](#) [009333-000](#) [727844N003](#) [747](#) [809090N001](#) [843188-000](#) [8666](#) [967279N002](#) [DB-11](#) [1300840039](#) [1300900096](#) [1301800416](#)
[1302264450](#) [1300830184](#) [1300830729](#) [1300900039](#) [1301580036](#) [1301850553](#) [1301860939](#) [1302000074](#) [1302261315](#) [1302264431](#)
[1337706-2](#) [APA18-AK](#) [1724](#) [1-787307-1](#) [185491N001](#) [1868](#) [HP-6N](#) [C-202-C](#) [202C221-13-0](#) [CA7308-000](#) [8S23-75FR-CS8184](#) [2684](#) [9648](#)
[3089](#) [988382-000](#) [A72821-000](#) [AA401](#) [173506-000](#) [1823](#) [202C292-13-0](#) [202C302-13-0](#) [2109](#) [300625](#) [3330](#) [3412](#) [356247-1](#) [M9142](#)
[M9143](#)