

Mini-Com® Faceplate Frames and Inserts

specifications

Faceplate frames shall be available in single and double gang versions and shall accept a variety of inserts. Executive design faceplate frames shall have a curved appearance and include labels and label covers. Classic design faceplate frames shall have a flush appearance and include color matched mounting screws. Inserts shall be available in sloped, sloped shuttered, and flat versions, and accept all modules for increased design flexibility. Modules shall be accessible from the front for easy moves, adds, and changes.



technical information

Mounting options:	Faceplate frames are compatible with wall board adapters (MWBA1 and MWBA-2G); single or double junction boxes; raceway mounting brackets
Packaging:	Executive series faceplate frames include two labels, two label covers; all faceplate frames include 1" long #6-32 slotted pan head screws with non-threaded lead point

key features and benefits

Modular	Faceplate frames accept all Panduit Inserts; inserts accept all Mini-Com® Modules for design flexibility
Front access	Mini-Com® Modules are accessible from the front for easy moves, adds, and changes
Sloped versions	Provide additional bend radius control to protect cable
Shuttered versions	Integrated shuttered door keeps dust and debris out of unmated Mini-Com® Jack Modules
Identification	Executive series faceplate frames can be clearly identified with labels; classic series faceplate frames can be clearly identified with optional adhesive labels; sloped shuttered version available with label option; Mini-Com® Modules can be clearly identified with optional icons

applications

The combination of faceplate frames and inserts provide the design flexibility when installing connectivity in single or double gang junction boxes, wallboard adapters, and raceway mounting brackets. A variety of inserts enable front access to connectivity for easy moves, adds, and changes.

Sloped inserts are ideal for installations which require additional bend radius control and blank inserts allow for future growth. All inserts accept Mini-Com® Modules for copper, fiber, and audio/video applications.

Mini-Com® Faceplate Frames and Inserts

Executive Series Faceplate Frames

Single gang: CBE**Y
Double gang: CBE**-2GY

Classic Series Faceplate Frames

Single gang: CB**^
Double gang: CB**-2G^

1/2 Size Inserts

Sloped: CHS2**-X
Sloped, shuttered: CHS1S**-X
Sloped, shuttered: CHS2S**-X
Sloped, shuttered with labels: CHLS2S**-X
Sloped, recessed: CHSRE2**-X
Flat: CHF2**-X
Blank: CHB2**-X

1/3 Size Inserts

Flat, 1 port: CHF1M**-X
Flat, 2 ports: CHF2M**-X
Blank: CHB2M**-X

1/3 Size D-Subminiature Inserts

9-pin, female to female coupler: CHD9C**Y
15-pin, female to female coupler: CHD15HDC**Y
15-pin, DB connector mounted to a circuit board: CHD15HDSC**Y

**To designate color, add suffix IW (Off White), EI (Electric Ivory), IG (International Gray), AW (Arctic White), WH (White), or BL (Black).
Not all parts are available in all colors; visit www.panduit.com for a complete listing of available colors.

^Frames CB** and CB**-2G require the following clearance when installing over a mud ring:
CB**=2.80"x1.74"
CB**-2G=2.83"x3.63"

Visit www.panduit.com for complete offering of copper, fiber, and audio/video modules.

Mini-Com® Faceplate Frames and Inserts

executive series faceplate frames

classic series faceplate frames

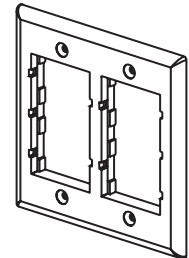
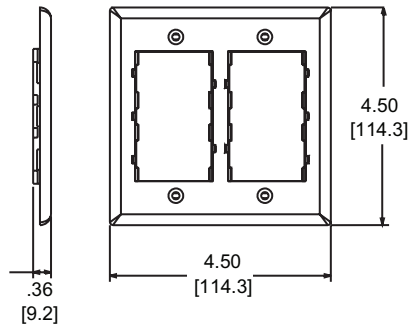
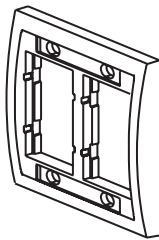
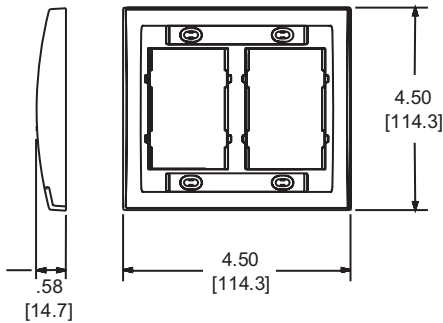
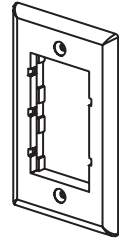
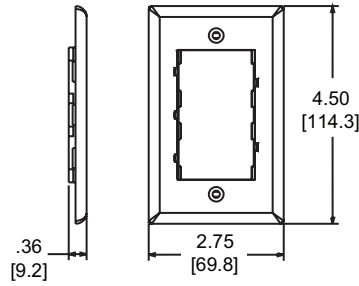
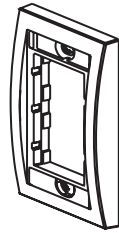
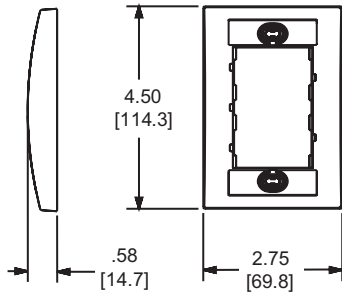

inserts

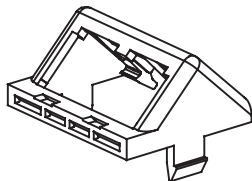

1/2 Sloped Insert

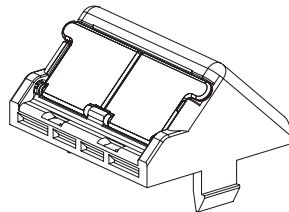

1/2 Sloped, Shuttered with or without Labels

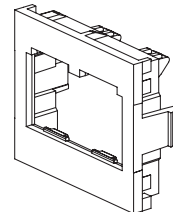

1/2 Flat Insert

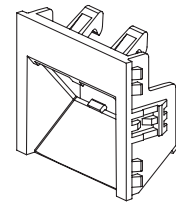

1/2 Sloped Recessed

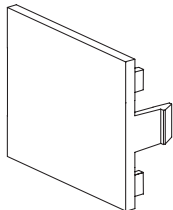

1/2 Blank Insert

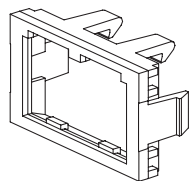

1/3 Flat Insert

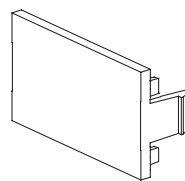

1/3 Blank Insert

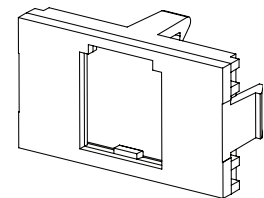

1/3 One Position Insert

Dimensions are in inches [Dimensions in brackets are metric].

WORLDWIDE SUBSIDIARIES AND SALES OFFICES

PANDUIT CANADA
Markham, Ontario
cs-cdn@panduit.com
Phone: 800.777.3300

PANDUIT EUROPE LTD.
London, UK
cs-emea@panduit.com
Phone: 44.20.8601.7200

PANDUIT SINGAPORE PTE. LTD.
Republic of Singapore
cs-ap@panduit.com
Phone: 65.6305.7575

PANDUIT JAPAN
Tokyo, Japan
cs-japan@panduit.com
Phone: 81.3.6863.6000

PANDUIT LATIN AMERICA
Guadalajara, Mexico
cs-la@panduit.com
Phone: 52.33.3777.6000

PANDUIT AUSTRALIA PTY. LTD.
Victoria, Australia
cs-aus@panduit.com
Phone: 61.3.9794.9020

For a copy of Panduit product warranties, log on to www.panduit.com/warranty

For more information

Visit us at www.panduit.com

Contact Customer Service by email: cs@panduit.com
or by phone: 800.777.3300

©2018 Panduit Corp.
ALL RIGHTS RESERVED.
OTSP38--WW-ENG
Replaces WW-OTSP15
12/2018

X-ON Electronics

Largest Supplier of Electrical and Electronic Components

Click to view similar products for [Wire Ducting & Raceways](#) category:

Click to view products by [Panduit](#) manufacturer:

Other Similar products are found below :

[800A-LB](#) [801I-LSP](#) [802A-ECSP](#) [802I-ICSP](#) [923223-000](#) [PRAF6WH-X](#) [A0405538](#) [1301150342](#) [1301160034](#) [1301170070](#) [1301180011](#)
[1301230083](#) [1301230153](#) [1301240273](#) [1301250006](#) [1302261238](#) [1302261321](#) [1302262552](#) [1302263103](#) [1302263178](#) [1302263259](#)
[1302263816](#) [1302263860](#) [1302264375](#) [1302264390](#) [1301150343](#) [1301160030](#) [1301170050](#) [1301170051](#) [1301170061](#) [1301180013](#)
[1301230086](#) [1301230130](#) [1301240054](#) [1302260055](#) [1302260376](#) [1302261343](#) [1302261344](#) [1302262674](#) [1302263095](#) [1302263166](#)
[1302263209](#) [1302263513](#) [1302263851](#) [1302263870](#) [1302264137](#) [1302264218](#) [DD1/J](#) [AX101472](#) [AX102007](#)