

45° Angled Wire Caps for TX6A, TX6 PLUS and TX5e Mini-Com® UTP Jack Modules

PANDUIT®

SPECIFICATION SHEET

specifications

45° angled wire caps, when mated with compatible UTP jack modules, shall provide improved cable routing to jacks in confined spaces. Angled wire caps shall terminate 4-pair, 22 - 26 AWG, 100 ohm unshielded twisted pair cable and shall use a forward motion termination method to optimize performance by maintaining cable pair geometry while eliminating conductor untwist.



The wire caps shall be color-coded to designate performance category and shall include a universal label coded for T568B wiring schemes.

technical information

Channel and component performance[^]:	Exceeds channel and component requirements of ANSI/TIA-568-C.2 and ISO 11801 standards for the respective Category or Class performance levels at the designated swept frequencies for that Category or Class
IEC compliance[^]:	Meets IEC 60603-7
RoHS compliance:	Compliant
PoE compliance[^]:	Supports 2500 connection cycles with IEEE 802.3af / 802.3at and proposed 802.3bt type 3 and type 4
UL rated[^]:	UL 1863 and UL 2043
Operating temperature:	-10°C to 65°C (14°F to 149°F)
Conductor termination range:	Compatible with 22 – 26 AWG solid or stranded cable with conductor insulation diameters of 0.060 in. max. and overall cable O.D. 0.200 in. to 0.330 in
Depth reduction provided:	Allows 55% reduction in cable routing depth compared to straight exit wire cap with both allowing proper cable bend radius for 0.275 inch (6.99 mm) diameter cable (0.500" with angled caps vs. 1.100" with straight exit caps)

[^]When mated to compatible UTP jack modules.

key features and benefits

Angled cable exit:	Large diameter cable can be routed to jacks in tight spaces while maintaining proper bend radius; also can be used on multiple jacks positioned next to each other
Reversible direction design:	Both wire cap versions can be inserted into compatible jacks in either direction, bringing the convenience of needing only two parts to handle up, down, left, or right cable routing needs
Wide compatibility:	Immediate compatibility with Panduit's most common Mini-Com® UTP jacks
Economical:	Angled wire caps can easily be applied to new or already installed compatible jacks to gain routing advantages without needing to purchase new jacks
Uses enhanced Giga-TX Technology:	Optimizes performance by eliminating conductor untwist and reduces installation time and expense
Consistent termination design:	Similarity in both conductor management and termination method to Panduit's most common straight exit Mini-Com® UTP jacks; ensures minimal learning curve and fast field terminations
Termination tool available:	TGSJT termination tool functions for both wire cap versions and ensures conductors are fully terminated by utilizing a smooth forward motion without impact on critical internal components for maximum reliability

applications

45° Angled Wire Caps can be used with compatible TX6A, TX6 PLUS and TX5e Mini-Com® UTP Jack Modules where ever an angled cable exit from the modular jack is desired and in confined jack mounting spaces such as in modular furniture, raceway, and wall outlets with conduit. 45° Angled Wire Caps are especially beneficial for use with Category 6A cabling which is increasingly being

deployed in office and furniture applications, since their angled routing better accommodates the larger bundle diameter and bigger bend radius of Category 6A cable.

45° Angled Wire Caps for Mini-Com® UTP Jack Modules

Up/Down 45° Angle Caps

TX6A™:	CJUDCAPBU-%
TX6™ PLUS:	CJUDCAPIW-%
TX5e™:	CJUDCAPRD-%

Left/Right 45° Angle Caps

TX6A™:	CJLRCAPBU-%
TX6™ PLUS:	CJLRCAPIW-%
TX5e™:	CJLRCAPRD-%

Compatible Mini-Com® UTP Jack Modules TX6A™ UTP with MaTriX Technology

Mini-Com® UTP Jack Modules

TX6A™:	CJ6X88TG*
TX6™ PLUS:	CJ688TG*
TX5e™:	CJ5E88TG*

Mini-Com® Spring Shuttered UTP Jack Modules

TX6A™:	CJH6X88TG*
TX6™ PLUS:	CJH688TG*
TX5e™:	CJH5E88TG*

Tools and Accessories Jack module

Termination tool:	TGSJT
Wire snipping tool:	CWST
Wire stripping tool:	CJAST

% = Package size (X = 10, C = 100)
 * To designate color, add suffix IW (Off White), EI (Electric Ivory), IG (International Gray), AW (Arctic White), BL (Black), BU (Blue), RD (Red), YL (Yellow), GR (Green), OR (Orange), BR (Brown), GD (Gold), LB (Light Blue), PK (Pink) or VL (Violet).

45° Angled Wire Caps for TX6A, TX6 PLUS and TX5e Mini-Com® UTP Jack Modules

Up/Down 45° TG Wire Cap
CJUDCAPBU-^, CJUDCAPIW-^, CJUDCAPRD-^
(See Installation Instruction PN610)

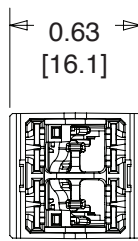
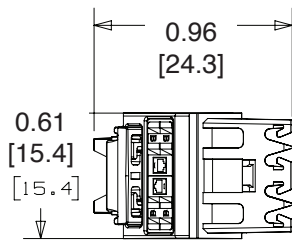
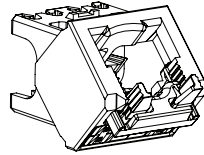
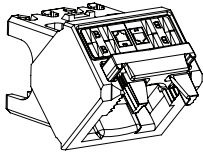

Left/Right 45° TG Wire Cap
CJLRCAPBU-^, CJLRCAPIW-^, CJLRCAPRD-^
(See Installation Instruction PN609)

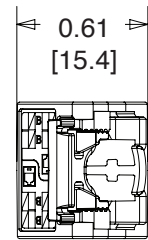
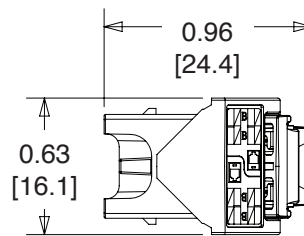
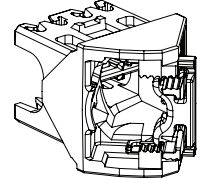
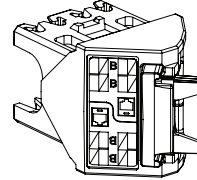

TGSJT Termination Tool
(Required for terminating 45° Angled Wire Caps)

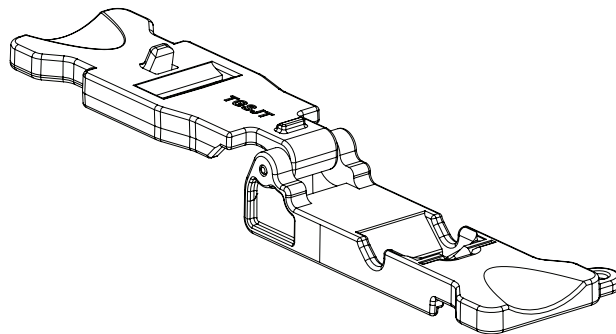

Wall thickness >1mm [0.039"].
Dimensions are in inches. [Dimensions in brackets are metric.]

45° Angled Wire Caps for TX6A, TX6 PLUS and TX5e Mini-Com® UTP Jack Modules

Panduit Up/Down 45° Angled Wire Caps Space Savings in Typical Wall Outlet Application

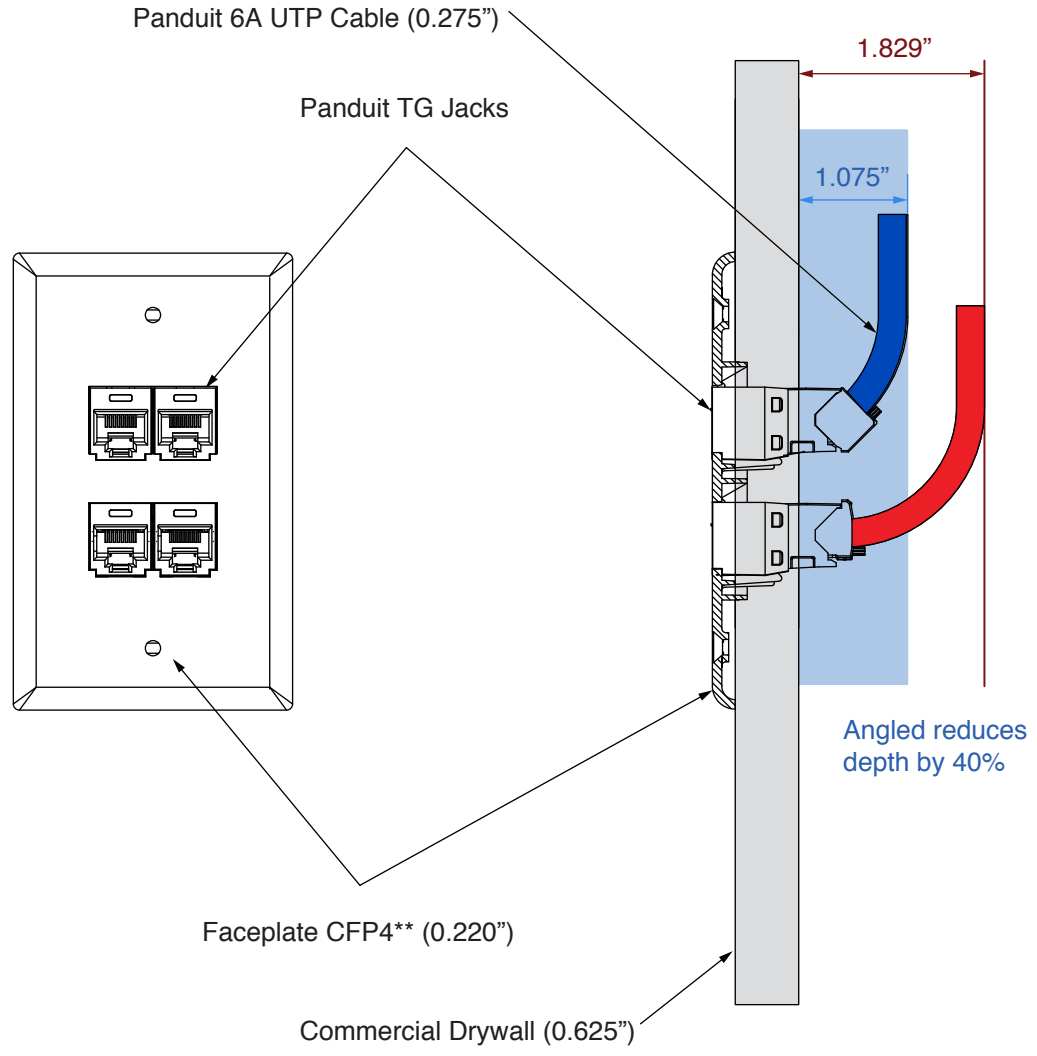

45° Angled Wire Caps for TX6A, TX6 PLUS and TX5e Mini-Com® UTP Jack Modules

Panduit Left/Right 45° Angled Wire Caps Space Savings in Typical Furniture Application

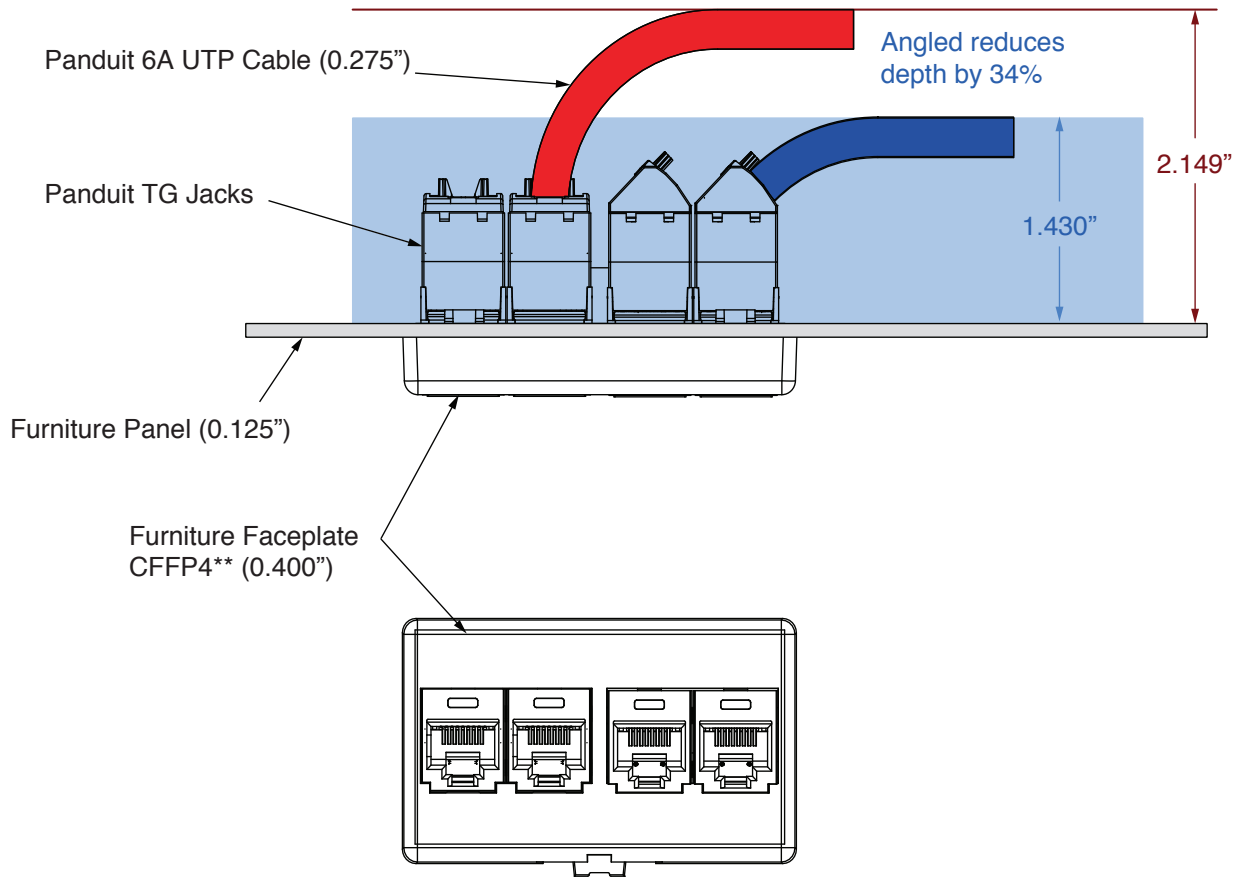

WORLDWIDE SUBSIDIARIES AND SALES OFFICES

PANDUIT US/
CANADA
Phone: 800.777.3300

PANDUIT EUROPE LTD.
London, UK
Phone: 44.20.8601.7200

PANDUIT SINGAPORE PTE. LTD.
Republic of Singapore
Phone: 65.6305.7575

PANDUIT JAPAN
Tokyo, Japan
Phone: 81.3.6863.6000

PANDUIT LATIN AMERICA
Guadalajara, Mexico
Phone: 52.33.3777.6000

PANDUIT AUSTRALIA PTY. LTD.
Victoria, Australia
Phone: 61.3.9794.9020

For a copy of Panduit product warranties, log on to www.panduit.com/warranty

For more information
Visit us at www.panduit.com

PANDUIT®

©2017 Panduit Corp.
ALL RIGHTS RESERVED.
COSP406--SA-ENG
4/2017

X-ON Electronics

Largest Supplier of Electrical and Electronic Components

Click to view similar products for [Modular Connectors / Ethernet Connectors](#) category:

Click to view products by [Panduit](#) manufacturer:

Other Similar products are found below :

[8949-H88/06BLKA/SN](#) [74441-0010/BKN](#) [MP1010RX-1000](#) [MP44RX-1000](#) [PHP-6P6C-5](#) [GAX-3-66](#) [GAX-8-62](#) [GDCX-PA-66-50](#) [GDCX-PN-64](#) [GDCX-PN-66](#) [GDCX-PN-66-50](#) [GDLX-A-66](#) [GDLX-N-66](#) [GDLX-S-66](#) [GDLX-S-88K](#) [GDTX-S-88-50](#) [GDX-PA-1010](#) [GLX-N-1010M-BLK](#) [GLX-S-88M-BLK](#) [GMX-N-1010](#) [GMX-S-1010](#) [GMX-S-66](#) [GMX-SMT4-N-88](#) [GPX-2-64](#) [GSGX-N-2-88](#) [GSGX-N-4-88](#) [GSX-NS2-88-3.05](#) [GSX-NS2-88-3.05-50](#) [GSX-NS-88-3.05-50](#) [PT-108A-8C-UL](#) [PT-J951-8C](#) [PTS-J531-8CS-50UL](#) [1-1775629-2](#) [A-2014-0-4](#) [GWLX-S-88-GR](#) [GWLX-S9-88-YG](#) [DC-1021-8-WH-6](#) [1300530003](#) [1324640-4](#) [RJ11FTVC2G](#) [RJ11FTVC2N](#) [RJFTVX2SA1G](#) [132764-001](#) [1413235](#) [MP88X-1000](#) [MPS88RX-5000](#) [E5288-S000K3-L](#) [E5908-15A242-L](#) [155302-001](#) [AX100653](#)