

NOTES:

1. MATERIAL:  
BODY - ALUMINUM, TIN PLATED  
SCREW - ALUMINUM, TIN PLATED
2. UL LISTED & CSA CERTIFIED FOR USE UP TO 600V & TEMPERATURE RATED 90°C (AL9CU)
3. DUAL RATED FOR USE WITH COPPER OR ALUMINUM STRANDED CODE CONDUCTOR
4. THESE PARTS ARE RoHS COMPLIANT
5. USE OF OXIDE INHIBITING JOINT COMPOUND LIKE PANDUIT CMP-100 RECOMMENDED FOR PAD TO PAD AND CONDUCTOR SURFACES
6. SEE PACKAGING LABEL FOR TIGHTENING TORQUE INFORMATION
7. PKG QTY:  
1 = 1
8. \*\* DENOTES NEMA HOLE SPACING

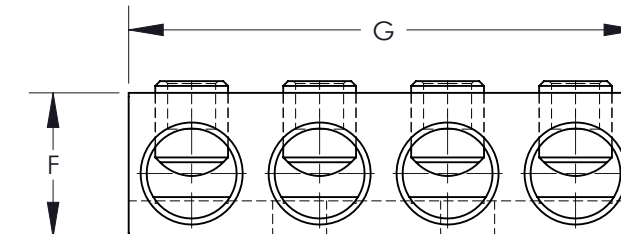
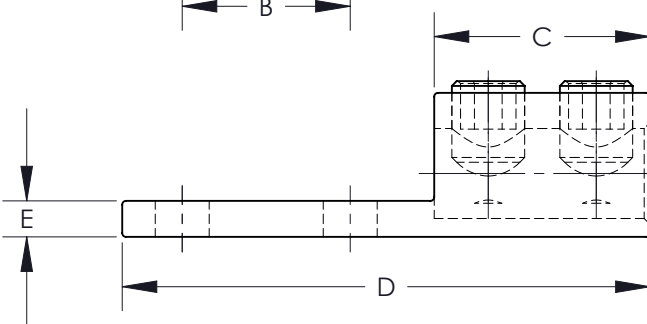
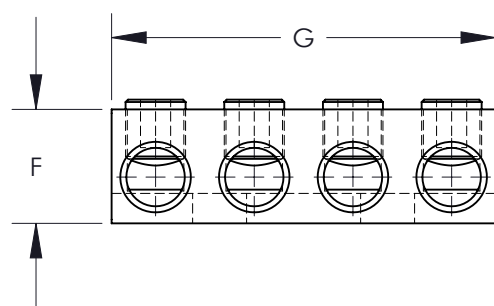
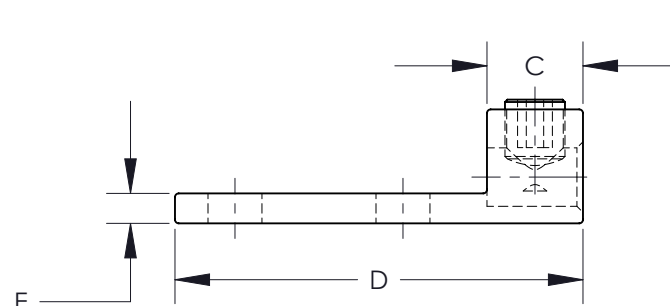
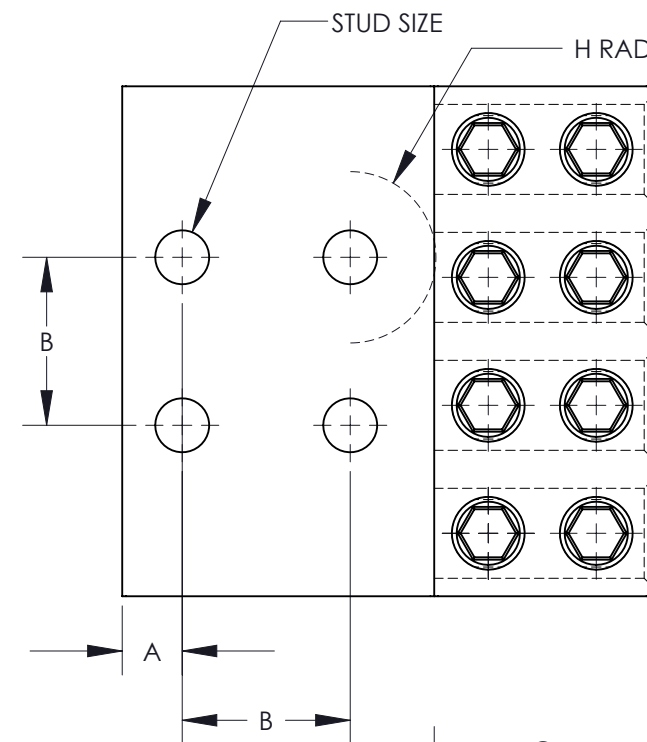
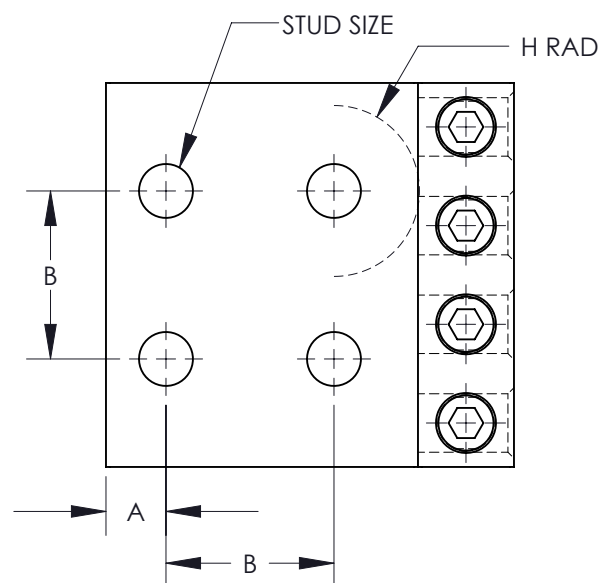

FIGURE 1

FIGURE 2

PART NUMBER	FIGURE	STUD SIZE	DIMENSIONS - IN [mm] +/- .02 [.5]								WIRE STRIP LENGTH	WIRE RANGE	HEX KEY*
			A	B	C	D	E	F	G	H			
LAM4D250-12-1Y	1	1/2	.63 [16.0]	**1.75 [44.5]	1.00 [25.4]	4.25 [108.0]	.31 [7.9]	1.19 [30.2]	4.00 [101.6]	.88 [22.4]	1.00 [25.4]	250kcmil - 6 AWG	5/16
LAM4D350-12-1Y	1	1/2	.63 [16.0]	**1.75 [44.5]	1.25 [31.8]	4.50 [114.3]	.31 [7.9]	1.37 [34.8]	4.72 [119.9]	.88 [22.4]	1.25 [31.8]	350kcmil - 6 AWG	5/16
LAM4LD600-12-1	2	1/2	.63 [16.0]	**1.75 [44.5]	2.25 [57.2]	5.50 [139.7]	.38 [9.7]	1.50 [38.1]	5.31 [134.9]	.88 [22.4]	2.25 [57.2]	600kcmil - 2 AWG	3/8
LAM4LD1000-12-1	2	1/2	.63 [16.0]	**1.75 [44.5]	2.75 [69.9]	6.19 [157.2]	.56 [14.2]	1.88 [47.8]	7.11 [180.6]	1.06 [26.9]	2.75 [69.9]	1000-350kcmil	1/2

\* HEX SIZE MAY DIFFER FROM CHART. DIFFERENCE IN SIZE WILL NOT AFFECT FIT, FORM, OR FUNCTION OF PART

							TITLE LAM4D, LAM4LD SERIES ALUMINUM MECHANICAL LUGS CUSTOMER DRAWING	
							ITEM REVISION NAME N41564BA-C41564/06	
							DATASET FILE NAME C41564/06.SLDDRW	
							UNLESS OTHERWISE SPECIFIED, DIMENSIONAL TOLERANCES ARE: IN [mm] .X ± .XXX ± .XX ± ANGLES ±	
							THIRD ANGLE PROJECTION	
06	6/15	JHNU	JHNU	RGB	REVISED G DIMENSION FOR LAM4D250-12-1Y: 4.00 WAS 4.04	N41564BA-C41564	DRAWING NUMBER C41564_06	
REV	DATE	BY	CHK	APR	DESCRIPTION	ECN	DRAWN BY JHNU	DATE 2/06
							CHK JHNU	SCALE NONE
							SHEET 1 OF 1	
							SIZE B	



SEE NOTES

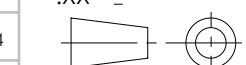

DRAWING NUMBER  
C41564\_06

DRAWN BY  
JHNU

DATE  
2/06

CHK  
JHNU

SCALE  
NONE

SHEET 1 OF 1

SIZE  
B

## X-ON Electronics

Largest Supplier of Electrical and Electronic Components

*Click to view similar products for [Terminals](#) category:*

*Click to view products by [Panduit](#) manufacturer:*

Other Similar products are found below :

[00-054007-01074-6](#) [00-054007-70206-1](#) [00-054007-70210-8](#) [00-054007-70217-7](#) [00-054007-70226-9](#) [00-054007-70228-3](#) [00-054007-70248-1](#) [00-054007-70256-6](#) [00-054007-70301-3](#) [00-054007-70316-7](#) [0-0320562-0](#) [00-054007-49560-4](#) [00-054007-70209-2](#) [00-054007-70225-2](#) [00-054007-70227-6](#) [00-054007-70231-3](#) [00-054007-70241-2](#) [00-054007-70242-9](#) [00-054007-70244-3](#) [00-054007-70246-7](#) [00-054007-70263-4](#) [00-054007-70288-7](#) [00-054007-70290-0](#) [00-054007-70300-6](#) [00-054007-70304-4](#) [01-2065-1-0216](#) [01-2900-1-04412](#) [00581P0075](#) [600TS-10](#) [60205-1](#) [604200-1](#) [605601-1](#) [60598-1-CUT-TAPE](#) [61314-6-C](#) [61810-3](#) [61-S](#) [61-SN](#) [626-0194](#) [62-NBM-A](#) [62-SN](#) [62-SP](#) [640179-1](#) [M55155/059I03](#) [M55155/079C01](#) [M55155/099H02](#) [M55155/109H01](#) [M55155/109H02](#) [M55155/12XH05](#) [M55155/16XH02](#) [M55155/29-5S](#)