





THIS COPY IS PROVIDED ON A RESTRICTED BASIS AND IS NOT TO BE USED IN ANY WAY DETRIMENTAL TO THE INTERESTS OF PANDUIT CORP.

PART NO.	BACKGROUND COLOR	LEGEND COLOR	DETAIL "A"
PEIP-A-18Y	PURPLE	WHITE	
PEIP-A-19Y	GREEN	WHITE	
PEIP-A-20Y	BLUE	WHITE	
PEIP-A-21Y	RED	WHITE	
PEIP-A-22Y	ORANGE	WHITE	

- NOTES:
 1. MILLIMETERS ARE IN [].
 2. 10 MARKER PER CARD.
 3. 10 CARDS PER PACKAGE.

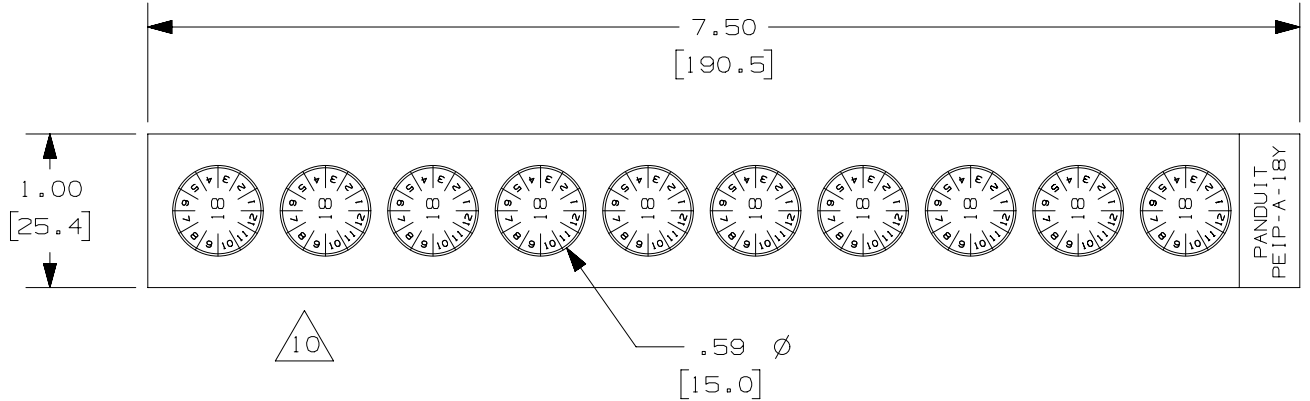

10	7/10/18	RVU	DJW	JHAC	REMOVED PEIP-A-17Y, ADD PEIP-A-22Y.	GAECN04624
9	1/4/17	RVU	DJW	JHAC	REMOVED PEIP-A-16Y, ADD PEIP-A-21Y.	GAECN03932
8	1/7/16	SMY	SEWH	JHAC	REMOVED PEIP-A-15Y, ADD PEIP-A-20Y.	GAECN03313
7	1/12/15	RVU	MJPF	MSAD	REMOVED PEIP-A-14Y. ADD PEIP-A-19Y.	GAECN02514
6	2/7/13	RVU	MJPF	MSAD	REMOVED PEIP-A-13Y. ADD PEIP-A-18Y.	GAECN01532
5	5/24/13	RVU	MJPF	MSAD	GMV10-0L WAS GMV10 VINYL.	GAECN00662
4	2/7/13	RVU	MJPF	MSAD	REMOVED PEIP-A-12Y. ADD PEIP-A-17Y.	GAECN00593

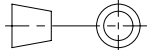
TITLE					
PEIP WRITE-ON MARKER LABEL					
CUSTOMER DRAWING					
ITEM REVISION NAME			100318HM/19		
DATASET FILE NAME			100318HM_DC_C10721/19N		
UNLESS OTHERWISE SPECIFIED, DIMENSIONAL TOLERANCES ARE: IN [mm]			PANDUIT TM		
.x ± .12 [3.05] .xxx ± .025 [.635] .xx ± .062 [1.57] ANGLES ±					
			THIRD ANGLE PROJECTION		
DRAWN BY			DATE		SCALE
RVU			7/28/08		MSAD NTS
DRAWING NUMBER:					SIZE
C10721					A
REV				DESCRIPTION	
DATE				ECN	
BY				SHT 1 OF 1	
CHK				A	
APR					

D10100DA/12

X-ON Electronics

Largest Supplier of Electrical and Electronic Components

Click to view similar products for [Wire Labels & Markers](#) category:

Click to view products by [Panduit](#) manufacturer:

Other Similar products are found below :

[89078GBEST](#) [89082GBESR](#) [89082GBEST](#) [PCL025-4](#) [5761-2SF](#) [58400](#) [586R734H02](#) [M1.040.0000.6](#) [CRS-CM5M](#) [CRS-M18M](#) [CS1836-000](#) [CS8626-000](#) [CU6337-000](#) [CU6342-000](#) [CU6343-000](#) [CWD01-0](#) [CWD012-0](#) [CWD012-7](#) [CWD015-3](#) [CWD015-7](#) [CWD02-0](#) [CWD02-3](#) [CWD02-4](#) [CWD02-6](#) [CWD02-8](#) [CWD02-A](#) [CWD02-D](#) [CWD02-H](#) [CWD02-K](#) [CWD02-L](#) [CWD02-M](#) [CWD02-P](#) [CWD02-Q](#) [CWD02-R](#) [CWD02-U](#) [CWD02-W](#) [CWD02-Y](#) [CWD03-+](#) [CWD03-0](#) [CWD03-P](#) [CWD06-0](#) [CWD06-8](#) [CWD06-9](#) [CWD06-L](#) [CWD06-N](#) [CWD09-0](#) [CWD09-5](#) [CWD09-7](#) [6806810001](#) [CZ2857-000](#)