

# Quick-Build™ Harness Board System

## A Revolutionary Modular Solution for Harness Manufacturers

The modular, reusable solution consists of 1' X 1' (305mm x 305mm) grid tiles and specially designed, repositionable accessories that improve the productivity of wire harness assembly builds by up to 18%. The Quick-Build™ Accessories are more effective than nail, magnetic, or snap-in routing fixture methods. Accessories easily twist and lock in place until you're ready to make a change for faster routing of wires and design flexibility.

Low-Volume-High-Mix (LVHM) manufacturers achieve the greatest savings due to reduced material costs -- up to 65% of layout and board builds. By reducing the number of bulky plywood boards, the Quick-Build™ Harness Board System delivers more than 50% in storage space savings. Whether you need to build a variety of wire and cable assemblies to meet different customer specifications or for prototyping new harness designs, the more you build, the greater your profitability.

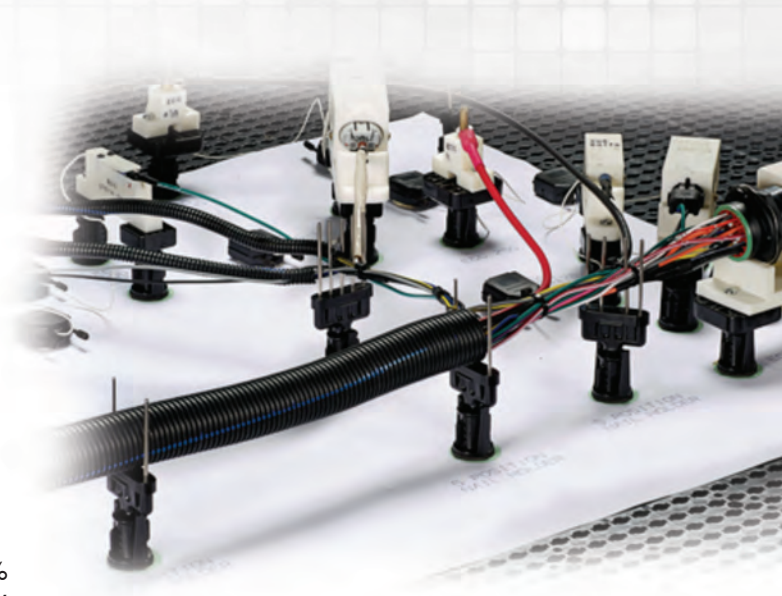

### Key Features      Benefits

<p><b>Modular Board Design</b> 1' x 1' (305mm x 305mm) Tiles</p>	<p><b>Improve Productivity</b></p> <ul style="list-style-type: none"> <li>• Reusable boards make it easy to move from one harness configuration to another</li> <li>• Scalable – Expand capacity as needed to accommodate various harness configurations</li> </ul> <p><b>Improve Profitability</b></p> <ul style="list-style-type: none"> <li>• Improve storage efficiency and reduce costly square footage from storing plywood harness boards not in use</li> <li>• Reduce labor needed to retrieve and store plywood harness boards</li> </ul>
<p><b>Patent-pending Hole Design</b></p>	<p><b>Improve Productivity</b></p> <ul style="list-style-type: none"> <li>• Locking mechanism is more effective than nails, magnetic or snap-in routing fixtures; accessories stay in place until you're ready to make a change</li> <li>• Easily move accessories from one hole to another to optimize harness layout</li> </ul> <p><b>Improve Profitability</b></p> <ul style="list-style-type: none"> <li>• Faster setup time as compared to the hammer and nail method</li> <li>• Reduce repetitive work and improve safety from use of hammer and nails</li> </ul>
<p><b>Reusable Accessories</b></p> <p><b>Complementary Offering To Traditional Harness Board Accessories</b></p>	<p><b>Improve Productivity</b></p> <ul style="list-style-type: none"> <li>• Reusable and repositionable accessories are designed to be rotated easily to accommodate cable routing pathway</li> <li>• Mounting platforms and mounting pegs improve setup by allowing accessories to be easily changed to ensure consistent harness board designs and configurations</li> <li>• Help to elevate harness routing above the board to allow efficient use of the Panduit Automatic Cable Tie Installation Tool as well as manually installing cable ties, labels, abrasion protection products, tape, etc.</li> </ul> <p><b>Improve Profitability</b></p> <ul style="list-style-type: none"> <li>• Use with existing Panduit Harness Board Accessories to create a modular system</li> <li>• Reduce expense of storing costly harness board accessories and test fixtures</li> </ul>

For more information, visit [www.panduit.com/QB](http://www.panduit.com/QB)

# Quick-Build™ Harness Board System

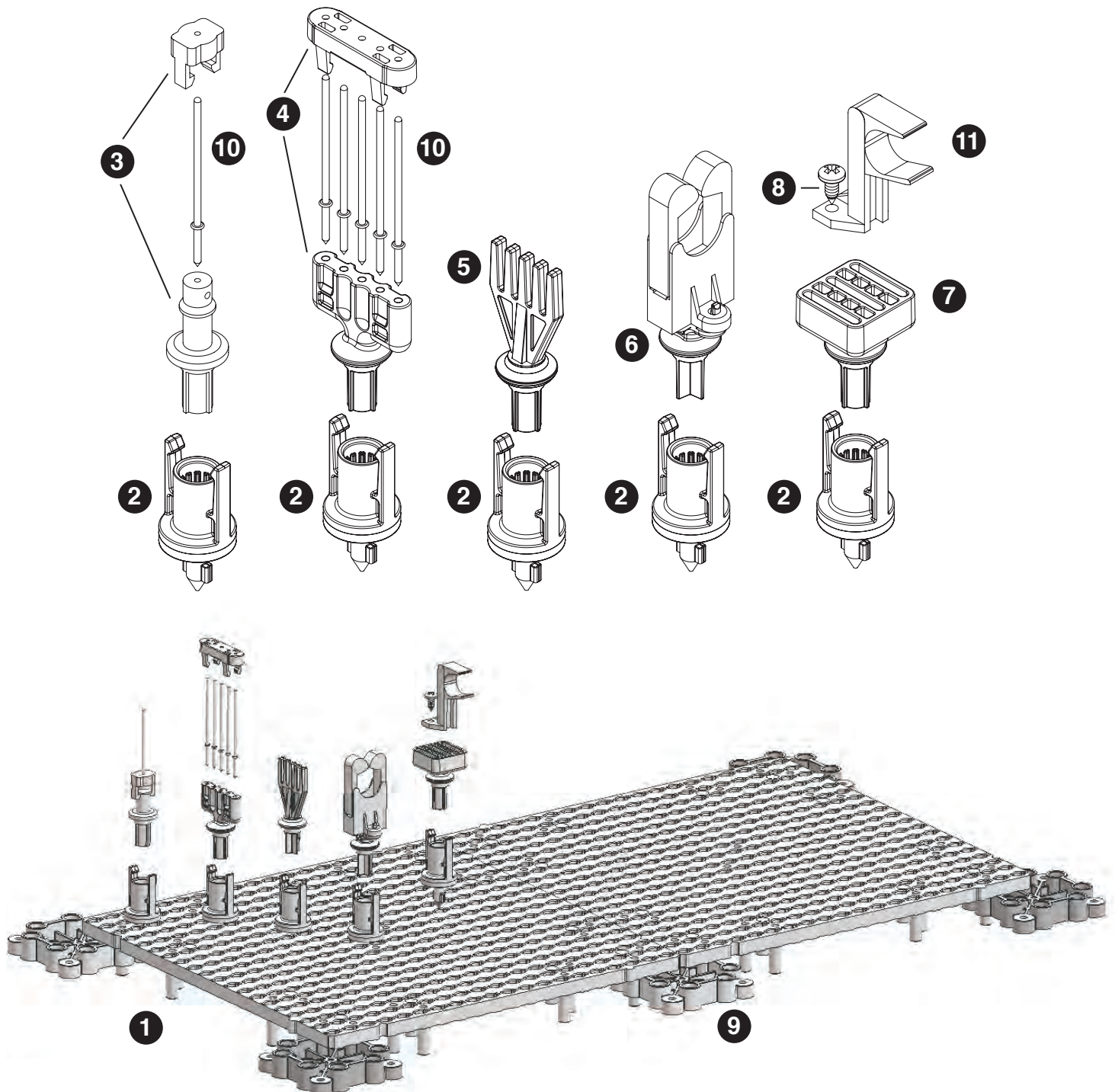

## Savings Add Up!

Quick-Build™ Harness Board savings can add up based on your unique variable information such as:

- Labor Cost/Hour
- Number of Board Variations / Harness Configurations
- Average Number of Changeovers for each Harness Annually

# Quick-Build™ Harness Board System

## Quick-Build™ Starter Kit



- Kit of Quick-Build™ Components and various harness board accessories allows customers to evaluate the Quick-Build™ Solution by simply ordering a single part number

Part Number	Description	Std. Pkg. Qty.
QB-KIT2	Starter Kit assortment that includes our core Quick-Build™ Components essential for faster wire harness builds. See table below for components included within this kit.	1

## QB-KIT2 Components

Part Number	Qty. Included
QB-TILE (8/PK)	8
QB-MOUNT-L	35
QB-WEH1012-Q	10
QB-WEH1416-Q	10
QB-WEH1822-Q	10
QB-FN1-Q	2
QB-FN2-Q	5
QB-FN3-Q	2
QB-SN1-Q	2
QB-SN2-Q	5
QB-SN3-Q	2
QB-RER.5-X	3
QB-RER.75-X	3
QB-RER1.25-X	2
HBN1-T	12
HBN2-T	30
HBN3-T	12

## Quick-Build™ Required Components

### Quick-Build™ Grid Tile



- Install on top of plywood with user-installed screws to provide surface for Quick-Build™ Mounting Pegs
- Optionally, connect with QB-CONN to prevent the need for plywood and to ensure accurate alignment of grid system

Part Number	Description	Std. Pkg. Qty.
QB-TILE	1' X 1' (305mm x 305mm) square base component that allows Quick-Build™ Mounting Pegs and platforms to create a modular harness system. One package includes 8 tiles. Black.	1 Pkg.

### Quick-Build™ Mounting Pegs

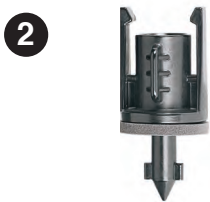

- Repositionable to allow user to build different harness configurations as needed
- Pointed end inserts through drawing secured to grid tiles, providing the ability to create a harness on top of a drawing

#### Replacement Washers

Part Number	Qty.
QB-WASHER-Q	25

Part Number	Description	Std. Pkg. Qty.
QB-MOUNT-L	Peg can be positioned and relocated. Required for use with Quick-Build™ Nail Holders, Quick-Build™ Wire End Holders, Quick-Build™ Replaceable Elastic Retainers, and Quick-Build™ Mounting Platforms to provide a modular harness board system. Allows accessories to rotate as needed even after mounting peg is installed into grid tile. Black.	50

# Quick-Build™ Harness Board System

## Quick-Build™ Core Component

### Quick-Build™ Single Nail Holder



- Requires the use of the Quick-Build™ mounting pegs to provide a modular solution
- Repositionable, allowing user to build different harness configurations as needed
- Allows the use of harness board nails (sold separately, see page 6)
- Use with single nails to create pathways and breakout channels

Part Number	Description	Compatible Harness Board Single Nail Part Number (see page 6)	Std. Pkg. Qty.
<b>QB-SN1-Q</b>	Single nail holder to accommodate one 1" nail. White.	HBN1-T	25
<b>QB-SN2-Q</b>	Single nail holder to accommodate one 2" nail. Black.	HBN2-T	25
<b>QB-SN3-Q</b>	Single nail holder to accommodate one 3" nail. Gray.	HBN3-T	25

### Quick-Build™ Five Nail Holder



- Requires the use of Quick-Build™ Mounting Pegs to provide a modular solution
- Repositionable, allowing user to build different harness configurations as needed
- Allows the use of up to five harness board nails (sold separately, see page 6)
- Use with nails to create pathways and breakout channels with harness board nails

Part Number	Description	Compatible Harness Board Single Nail Part Number (see page 6)	Std. Pkg. Qty.
<b>QB-FN1-Q</b>	Five nail holder to accommodate up to five 1" nails. White.	HBN1-T	25
<b>QB-FN2-Q</b>	Five nail holder to accommodate up to five 2" nails. Black.	HBN2-T	25
<b>QB-FN3-Q</b>	Five nail holder to accommodate up to five 3" nails. Gray.	HBN3-T	25

### Quick-Build™ Wire End Holders



- Requires the use of Quick-Build™ Mounting Pegs to provide a modular solution
- Repositionable, allowing user to build different harness configurations as needed
- Multiple sizes available to provide a securing point for different gauge wires

Part Number	Description	Std. Pkg. Qty.
<b>QB-WEH1012-Q</b>	Wire end holder for Quick-Build™ System. Suitable for #10 – #12 gauge wire. Holds three wires. Yellow.	25
<b>QB-WEH1416-Q</b>	Wire end holder for Quick-Build™ System. Suitable for #14 – #16 gauge wire. Holds four wires. Blue.	25
<b>QB-WEH1822-Q</b>	Wire end holder for Quick-Build™ System. Suitable for #18 – #22 gauge wire. Holds six wires. Red.	25



## Quick-Build™ Wire Elastic Retainers

6



- Requires the use of Quick-Build™ Mounting Pegs to provide a modular solution
- Repositionable, allowing user to build different harness configurations as needed
- Multiple sizes available to provide a securing point for different size bundles

Part Number	Description	Std. Pkg. Qty.
<b>QB-RER.5-X</b>	Quick-Build™ Peg with RER.5-S6-X pre-installed for use with Quick-Build™ System. Suitable for 1/2" bundle.	10
<b>QB-RER.75-X</b>	Quick-Build™ Peg with RER.75-S6-X pre-installed for use with Quick-Build™ System. Suitable for 3/4" bundle.	10
<b>QB-RER1.25-X</b>	Quick-Build™ Peg with RER1.25-S6-X pre-installed for use with Quick-Build™ System. Suitable for 1.25" bundle.	10
<b>QB-RERBASE-X</b>	Quick-Build™ Peg suitable for user to permanently install user-supplied RER.5-S6-X, RER.75-S6-X, or RER1.25-S6-X. Products sold separately – see page 6.	10

## Quick-Build™ Mounting Platform

7



- Requires the use of the Quick-Build™ Mounting Pegs to provide a modular solution
- Repositionable, allowing user to build different harness configurations as needed
- Provides the ability to rotate to allow breakouts and cable pathways to accommodate various harness design requirement
- Use Quick-Build™ Mounting Screws (sold separately, see below) to secure user supplied test fixtures and traditional harness board accessories (pages 6-7) to the Quick-Build™ Mounting Platform

Part Number	Description	Std. Pkg. Qty.
<b>QB-BASE175-Q</b>	Mounting platform that is inserted in Quick-Build™ Mounting Pegs 1.75" x 1.75" (44.45mm x 44.45mm). Allows traditional harness board accessories and user supplied test fixtures to create a complete Quick-Build™ Harness System. Compatible with: #4, #6, #8, and 1/4" screws. Screw length will vary based on test fixtures and accessories used. Consider multiple QB-BASE175-Q components for large test fixtures. Black.	25
<b>QB-BASE120-Q</b>	Mounting platform that is inserted in Quick-Build™ Mounting Pegs 1.2" x 1.2" (30.48mm x 30.48mm). Allows traditional harness board accessories and user supplied test fixtures to create a complete Quick-Build™ Harness System. Compatible with #8 screws. Screw length will vary based on test fixtures and accessories used. Consider multiple QB-BASE120-Q components for large test fixtures. Black.	25

## Quick-Build™ Screws

8



- Used to secure traditional harness board accessories and test fixtures to Quick-Build™ Mounting Platform
- Phillips/slot combination screw style

Part Number	Description	Std. Pkg. Qty.
<b>QB-S6-500-C</b>	#6 screw; 1/2" long	100
<b>QB-S8-500-C</b>	#8 screw; 1/2" long	100
<b>QB-S8-750-C</b>	#8 screw; 3/4" long	100
<b>QB-S25-500-C</b>	1/4" screw; 1/2" long	100
<b>QB-S25-1000-L</b>	1/4" screw; 1" long	50

## Quick-Build™ Grid Tile Connector

9



- Optional accessory for use with grid tiles to prevent the need for plywood backing and ensure accurate alignment of grid system
- Recommended for adjacent tiles where corners of two or four tiles come together

Part Number	Description	Std. Pkg. Qty.
<b>QB-CONN</b>	Grid tile connector to ensure accurate alignment of Grid System. One package includes five pieces. Black.	1 Pkg.

## Traditional Harness Board Accessories

Panduit harness board accessories have been around for a long time and continue to provide easy routing and forming of wires in harness fabrication.

### Harness Board Nails

10



- Manufactured from nickel plated steel
- Smooth finish on nails prevents abrasion to wire jackets

Part Number	Description	Compatible QB Components (see pg 4)	Std. Pkg. Qty.
<b>HBN1-T</b>	Harness board nail – 1" long (1.65" overall).	QB-SN1-Q and QB-FN1-Q	200
<b>HBN2-T</b>	Harness board nail – 2" long (2.66" overall).	QB-SN2-Q and QB-FN2-Q	200
<b>HBN3-T</b>	Harness board nail – 3" long (3.67" overall).	QB-SN3-Q and QB-FN3-Q	200

### Elastic Retainers – Replaceable Version

Not Shown



- Cable bundles are formed as individual wires are inserted
- Completed bundles can be easily removed
- The elastic band is replaceable

#### Replacement Elastic

Part Number	Qty.
<b>RER.5E-X</b>	10
<b>RER.75E-X</b>	10
<b>RER1.25E-X</b>	10
<b>RER2.0E-X</b>	10

Part Number	Description	Compatible QB Components (see page 5)	Std. Pkg. Qty.
<b>RER.5-S6-X</b>	Elastic retainer with replaceable elastic band. Suitable for 0.5" maximum bundle capacity.	QB-BASE175-Q, QB-S6-500-C and QB-RERBASE-X	10
<b>RER.75-S6-X</b>	Elastic retainer with replaceable elastic band. Suitable for 0.75" maximum bundle capacity.		10
<b>RER1.25-S6-X</b>	Elastic retainer with replaceable elastic band. Suitable for 1.25" maximum bundle capacity.		10
<b>RER2.0-S6-X</b>	Elastic retainer with replaceable elastic band. Suitable for 2.0" maximum bundle capacity.		10

### Elastic Retainers

Not Shown



- Cable bundles are formed as individual wires are inserted
- Completed bundles can be easily removed

Part Number	Description	Compatible QB Components (see page 5)	Std. Pkg. Qty.
<b>ER.5-E4-X</b>	Elastic Retainer. Suitable for 0.5" maximum bundle capacity.	QB-BASE175-Q and QB-S6-500-C	10
<b>ER1.25-E4-X</b>	Elastic Retainer. Suitable for 1.25" maximum bundle capacity.	QB-BASE175-Q and QB-S6-500-C	10

### Bundle Retainers

Not Shown



- Funnel entry allows fast cable insertion
- Completed bundles can be easily removed

Part Number	Description	Compatible QB Components (see page 5)	Std. Pkg. Qty.
<b>BR.5-E6-C</b>	Bundle retainer. Suitable for 0.5" maximum bundle capacity. 1.07" standoff height. Black.	QB-BASE175-Q and QB-S6-500-L	100
<b>BR.75-E6-C</b>	Bundle retainer. Suitable for 0.75" maximum bundle capacity. 0.95" standoff height. Black.	QB-BASE175-Q and QB-S6-500-L	100
<b>BR2-1.3-X</b>	Bundle retainer. Suitable for 2.0" maximum bundle capacity. 1.32" standoff height. Black.	QB-BASE175-Q and QB-S25-500-L	10
<b>BR2-1.5-X</b>	Bundle retainer. Suitable for 2.0" maximum bundle capacity. 1.59" standoff height. Black.	QB-BASE175-Q and QB-S25-1000-L	10
<b>BR2-4-X</b>	Bundle retainer. Suitable for 2.0" maximum bundle capacity. 4.06" standoff height. Black.	QB-BASE175-Q and QB-S25-1000-L	10
<b>BR2-6-X</b>	Bundle retainer. Suitable for 2.0" maximum bundle capacity. 6.02" standoff height. Black.	QB-BASE175-Q and QB-S25-1000-L	10

## Corner Posts

11



- Designed to pre-form tight bundles at harness corners and breakouts
- Top arm rotates upward for easy removal of completed harness

Part Number	Description	Compatible QB Components (see page 5)	Std. Pkg. Qty.
<b>CPH.75-S8-X</b>	Corner post to assist in tight corners of harness systems. 0.75" maximum bundle diameter. Center of bundle is 1.35" from surface.	QB-BASE120-Q or QB-BASE175-Q and QB-S8-500-C	10
<b>CPL.75-S8-X</b>	Corner post to assist in tight corners of harness systems. 0.75" maximum bundle diameter. Center of bundle is 0.56" from surface.	QB-BASE120-Q or QB-BASE175-Q and QB-S8-500-C	10

## Wire End Holder

Not Shown



- Secures wire ends while harness is being fabricated
- Use with #28 thru #16 AWG wires

Part Number	Description	Compatible QB Components (see page 5)	Std. Pkg. Qty.
<b>WEH-E8-C</b>	Use to retain end of wire in secure position. Helps when making terminations or dressing harness.	QB-BASE120-Q or QB-BASE175-Q and QB-S8-500-C	100

## Fanning Strip System

Not Shown



- Holds wires in a specific orientation
- No sharp edges to damage wire insulation
- Accepts wires up to 18 AWG
- Fanning strip can remain as part of completed harness

Part Number	Description	Compatible QB Components (see page 5)	Std. Pkg. Qty.
<b>FSH40-X</b>	Fanning strip holder to elevate FS156 fanning strip 0.62" above surface. 6.00" long. Black.	QB-BASE120-Q or QB-BASE175-Q and QB-S8-500-C	10
<b>FSHH-X</b>	Fanning strip holder to elevate FS156 fanning strip 1.42" above surface. 3.2" long. Black.	QB-BASE120-Q or QB-BASE175-Q and QB-S8-500-C	10
<b>FS156-C</b>	Fanning strip with 76 spaces for wires up to 18 AWG. 12.1" long and 0.31" tall.	N/A	100

## Spring Wire Breakout System

Not Shown





- Harness board spring and spring holder secures wire ends while harness is being fabricated
- Wires simply pull out from spring when harness is removed
- Each SHH spring holder is supplied with one rigid wire piece to hold the spring laterally and two #8 (M4), 2" (50.8mm) hex head wood screws; purchase spring separately.

Part Number	Description	Compatible QB Components (see page 5)	Std. Pkg. Qty.
<b>SHH1-S8-X</b>	Spring wire holder that elevates spring 1.3" above surface. Compatible with PBSC1-X spring. Black.	QB-BASE120-Q or QB-BASE175-Q and QB-S8-500-C	10
<b>SHH3-S8-X</b>	Spring wire holder that elevates spring 1.3" above surface. Compatible with PBSC3-X spring. Black.	QB-BASE120-Q or QB-BASE175-Q and QB-S8-500-C	10
<b>PBSC1-X</b>	Spring compatible with SHH1-S8-X spring wire holder.	N/A	10
<b>PBSC3-X</b>	Spring compatible with SHH3-S8-X spring wire holder.	N/A	10
<b>PBSC6-X</b>	Spring used independent of spring wire holder. Requires 6" spacing for mounting. Can be secured directly to Quick-Build™ Mounting Platform.	QB-BASE175-Q and QB-S25-500-L	10
<b>PBSC12-X</b>	Spring used independent of spring wire holder. Requires 12" spacing for mounting. Can be secured directly to Quick-Build™ Mounting Platform.	QB-BASE175-Q and QB-S25-500-L	10

Items in **BOLD** are core components for the Quick-Build™ System.

# Quick-Build™ Harness Board System

## Complete your harness assembly with:

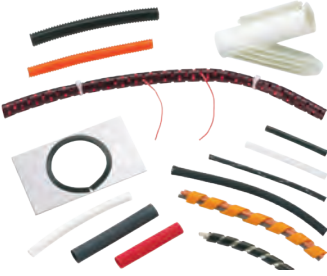
	<p><b>Automatic Cable Tie Installation Systems and Reel-Fed Cable Ties</b></p> <ul style="list-style-type: none"><li>• Engineered for high-volume efficiency and operator ease to minimize installed costs and boost profits</li><li>• Reduce reel-change downtime with Panduit continuous, reel-fed cable ties</li></ul> <p><b>6X FASTER</b> than conventional cable tie installation systems</p> <p><b>LESS THAN 1 SECOND</b> Wrap, tension and cut cable ties in less than 1 second</p>
	<p><b>Automated Termination System</b></p> <ul style="list-style-type: none"><li>• Speeds the process of indexing and crimping connectors resulting in consistent quality terminations to minimize installed cost and boost profits</li><li>• Choose from a wide selection of molded disconnects, splices, rings, forks, pins, and ferrules on reels</li></ul> <p><b>Measure your productivity gains:</b></p> <p><b>Fast and easy die changeovers save time</b></p> <p><b>UP TO 30% FASTER</b> crimp cycle time</p>
	<p><b>Identification</b></p> <ul style="list-style-type: none"><li>• Proper wire harness identification improves quality assurance and ensures compliance with industry standards</li><li>• Desktop printers and labeling software provide fast, high-quality label production</li><li>• Available in a wide variety of materials for wire and cable identification, including heat shrink labels, self-laminating labels, turn-tell labels, and marker plates</li></ul> <p><b>Reduce time for labeling by up to 75%</b></p>
	<p><b>Abrasion Protection</b></p> <ul style="list-style-type: none"><li>• Insulate, protect, and color code wires to help ensure high-quality performance even in demanding environments</li><li>• Choose from Pan-Wrap™, spiral wrap, corrugated loom tubing and braided sleeving, and heat shrink</li></ul> <p><b>Protect from vibration and environmental factors</b></p> <p><b>Bundle and route wires and cables efficiently</b></p>

### WORLDWIDE SUBSIDIARIES AND SALES OFFICES

PANDUIT CANADA  
Markham, Ontario  
cs-cdn@panduit.com  
Phone: 800.777.3300

PANDUIT EUROPE LTD.  
London, UK  
cs-emea@panduit.com  
Phone: 44.20.8601.7200

PANDUIT SINGAPORE PTE. LTD.  
Republic of Singapore  
cs-ap@panduit.com  
Phone: 65.6305.7575

PANDUIT JAPAN  
Tokyo, Japan  
cs-japan@panduit.com  
Phone: 81.3.6863.6000

PANDUIT LATIN AMERICA  
Guadalajara, Mexico  
cs-la@panduit.com  
Phone: 52.33.3777.6000

PANDUIT AUSTRALIA PTY. LTD.  
Victoria, Australia  
cs-aus@panduit.com  
Phone: 61.3.9794.9020

For a copy of Panduit product warranties, log on to [www.panduit.com/warranty](http://www.panduit.com/warranty)

**For more information**

**Visit us at [www.panduit.com](http://www.panduit.com)**

**Contact Customer Service by email: [cs@panduit.com](mailto:cs@panduit.com)  
or by phone: 800.777.3300**

# PANDUIT®

©2017 Panduit Corp.  
ALL RIGHTS RESERVED.  
WACB28--SA-ENG  
2/2017



## X-ON Electronics

Largest Supplier of Electrical and Electronic Components

*Click to view similar products for [Cable Mounting & Accessories](#) category:*

*Click to view products by [Panduit](#) manufacturer:*

Other Similar products are found below :

[582603-1](#) [009333-000](#) [727844N003](#) [747](#) [809090N001](#) [843188-000](#) [8666](#) [967279N002](#) [DB-11](#) [1300840039](#) [1300900096](#) [1301800416](#)  
[1302264450](#) [1300830184](#) [1300830729](#) [1300900039](#) [1301580036](#) [1301850553](#) [1301860939](#) [1302000074](#) [1302261315](#) [1302264431](#)  
[1337706-2](#) [APA18-AK](#) [1724](#) [1-787307-1](#) [185491N001](#) [1868](#) [HP-6N](#) [C-202-C](#) [202C221-13-0](#) [CA7308-000](#) [8S23-75FR-CS8184](#) [2684](#) [9648](#)  
[3089](#) [988382-000](#) [A72821-000](#) [AA401](#) [173506-000](#) [1823](#) [202C292-13-0](#) [202C302-13-0](#) [2109](#) [300625](#) [3330](#) [3412](#) [356247-1](#) [M9142](#)  
[M9143](#)