

THIS COPY IS PROVIDED ON A RESTRICTED BASIS AND IS NOT TO BE USED IN ANY WAY DETRIMENTAL TO THE INTERESTS OF PANDUIT CORP.

TWIST TIE

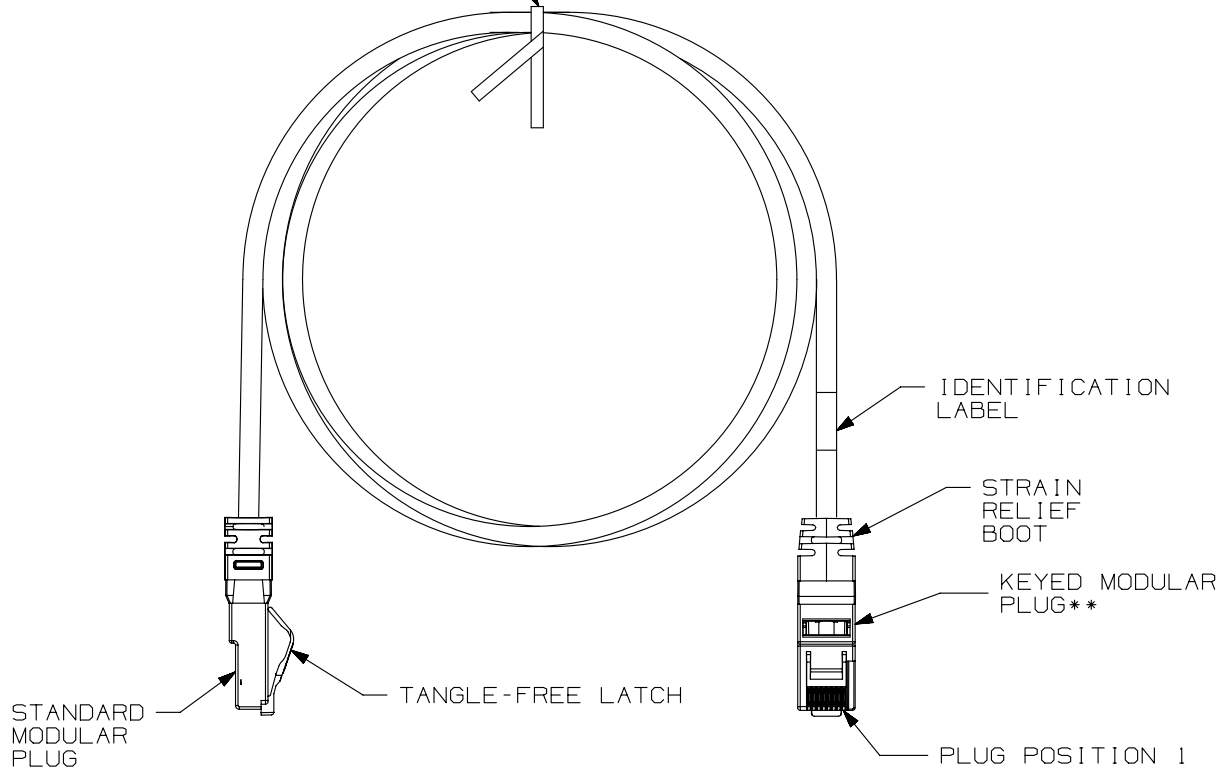

PANDUIT PART NUMBER	MIN. CABLE LENGTH	WEIGHT
UTPK6A3**	3 FT.	.095 LB/EACH (43.1 g/EACH)
UTPK6A5**	5 FT.	.150 LB/EACH (68.0 g/EACH)
UTPK6A7**	7 FT.	.205 LB/EACH (93.0 g/EACH)
UTPK6A10**	10 FT.	.260 LB/EACH (117.9 g/EACH)
UTPK6A14**	14 FT.	.395 LB/EACH (179.2 g/EACH)
UTPK6A1M**	1 METER	.103 LB/EACH (46.6 g/EACH)
UTPK6A2M**	2 METERS	.193 LB/EACH (87.4 g/EACH)
UTPK6A3M**	3 METERS	.283 LB/EACH (128.4 g/EACH)
UTPK6A5M**	5 METERS	.460 LB/EACH (209.0 g/EACH)
UTPK6A7M**	7 METERS	.751 LB/EACH (304.6 g/EACH)
UTPK6A10M**	10 METERS	1.073 LB/EACH (486.5 g/EACH)

** P/N CODE FOR KEYED PLUG HOUSING COLOR, CABLE COLOR AND SPECIAL KEY CONFIGURATION. SEE SHEET 2 FOR DETAILS.

NOTES:

- SEE CURRENT CATALOG FOR VARIOUS APPLICATIONS AND TO INDICATE COLOR AND OR PACKAGE QUANTITY.
- SEE CATALOG FOR A COMPLETE LIST OF PARTS APPLICABLE FOR USE WITH THIS PART.

T568B WIRING SCHEME

PLUG POSITION:	CABLE WIRE:
1	WHITE/ORANGE
2	ORANGE
3	WHITE/GREEN
4	BLUE
5	WHITE/BLUE
6	GREEN
7	WHITE/BROWN
8	BROWN

PART NUMBER		UTPK6A***	
TITLE			
TX6A 10GIG UTP KEYED PATCH CORDS		CUSTOMER DRAWING	
ITEM REVISION NAME		M03011EN/00	
DATASET FILE NAME		M03011EN_DC66/00C	
UNLESS OTHERWISE SPECIFIED, DIMENSIONAL TOLERANCES ARE: IN (mm)		MATERIAL:	
.x ± .xx ± .03 (.8)		.xxx ± .010 (.3)	
ANGLES ±		DRAWING NUMBER:	
THIRD ANGLE PROJECTION		03011-66	
DRAWN BY	DATE	CHK	SCALE
MDJr	12-10-08	PBD	NONE
SHT 1 OF 2			SIZE
			A

REV	DATE	BY	CHK	APR	DESCRIPTION	ECN
2	4-4-14	BJN	JSP	EJH	REVISED & REDRAWN PREVIOUS REVISIONS REMVD FOR CLARITY	03011-66

D10100DA/14

2

1

THIS COPY IS PROVIDED ON A RESTRICTED BASIS AND IS NOT TO BE USED IN ANY WAY DETRIMENTAL TO THE INTERESTS OF PANDUIT CORP.

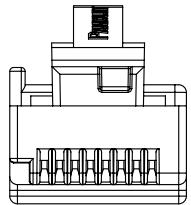
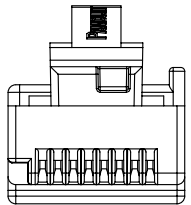
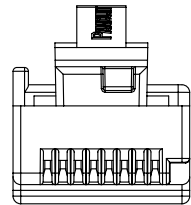
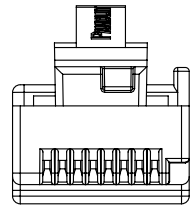
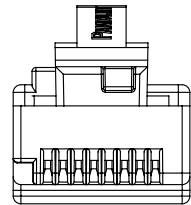
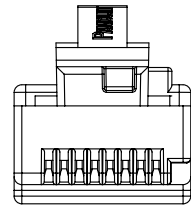
**PATCH CORD COLOR/KEY CODE					
A - BLACK	B - RED	C - GREEN	D - YELLOW	E - ORANGE	F - BLUE
					
BL	RD	GR	YL	OR	BU

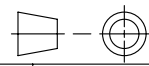
PART NUMBER		UTPK6A**	
TITLE		TX6A 10GIG UTP KEYED PATCH CORDS	
		CUSTOMER DRAWING	
ITEM REVISION NAME		M03011EN/00	PANDUIT
DATASET FILE NAME		M03011EN_DC66/00C	
UNLESS OTHERWISE SPECIFIED, DIMENSIONAL TOLERANCES ARE: IN (mm)		MATERIAL:	
.x ± .xxx ± .010 (.3)		DRAWING NUMBER:	
.xx ± .03 (.8) ANGLES ±		03011-66	
		THIRD ANGLE PROJECTION	
DRAWN BY	DATE	CHK	SCALE
MDJr	12-10-08	PBD	NONE
REV	DATE	BY	CHK
2	4-4-14	BJN	JSP
		EJH	
DESCRIPTION		APR	ECN
SEE SHEET 1 OR REVISION HISTORY			03011-66
SHT 2 OF 2		SIZE	
		A	

D10100DA/14

2

1

X-ON Electronics

Largest Supplier of Electrical and Electronic Components

Click to view similar products for [Ethernet Cables / Networking Cables](#) category:

Click to view products by [Panduit](#) manufacturer:

Other Similar products are found below :

[73-6670-7](#) [73-6680-15](#) [73-7797-25](#) [MCJB2-10P6Q7-120](#) [84909-0204](#) [1200700174](#) [1200860368](#) [E16A06002M030](#) [E200102-009-S1](#)
[AX105346-EW](#) [MT14-187L](#) [17-103530](#) [ERWPAB3002M005](#) [190-038045-01](#) [NK5EPC18RDY](#) [NK5EPC18VLY](#) [NK5EPC18YLY](#)
[NK5EPC1GRY](#) [NK5EPC4Y](#) [NK5EPC6YLY](#) [NK5EPC8BLY](#) [NK5EPC9YLY](#) [1969343-6](#) [C501100010](#) [C501106002](#) [C501106007](#)
[C501106015](#) [C501106025](#) [C601102010](#) [C601104010](#) [C601106007](#) [C601106015](#) [2142758-2](#) [2168427-2](#) [CAT1106007](#) [21949-1](#) [2J1866A](#)
[RJF SFTP 5E 0500](#) [AX100351](#) [MN14CEC/ST](#) [C501100015](#) [C501106004](#) [C501106010](#) [C5F1108007](#) [C601104004](#) [C601106004](#)
[CA21106004](#) [CA21106010](#) [CA21106015](#) [CA21109007](#)