



BAT54W-AU SERIES

SURFACE MOUNT SCHOTTKY DIODES

Voltage	30 V	Current	0.2 A
----------------	-------------	----------------	--------------

Features

- Low turn-on voltage
- Fast switching
- PN Junction Guard Ring for Transient and ESD Protection
- Lead free in compliance with EU RoHS 2.0
- Green molding compound as per IEC 61249 standard
- AEC-Q101 qualified

Mechanical Data

- Case: SOT-323 Package
- Terminals: Solderable per MIL-STD-750, Method 2026
- Approx. Weight: 0.0002 ounces, 0.005 grams

SOT-323

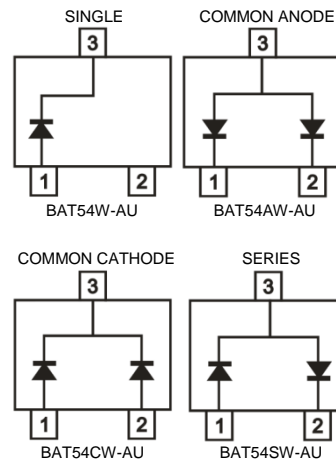
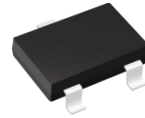

Maximum Ratings and Thermal Characteristics (T_A = 25 °C unless otherwise noted)

PARAMETER	SYMBOL	LIMIT	UNITS
Maximum Repetitive Peak Reverse Voltage	V _{RRM}	30	V
Maximum Rms Voltage	V _{RMS}	21	V
Maximum Dc Blocking Voltage	V _{DC}	30	V
Maximum Average Forward Current	I _{F(AV)}	0.2	A
Peak Forward Surge Current : 1 s Single Half Sine-Wave Superimposed On Rated Load	I _{FSM}	0.6	A
Typical Junction Capacitance Measured at 1 MHZ And Applied V _R = 1 V	C _J	10	pF
Typical Thermal Resistance	R _{θJA} ⁽¹⁾	540	°C/W
Operating Junction Temperature Range	T _J	-55~125	°C
Storage Temperature Range	T _{STG}	-55~125	°C



BAT54W-AU SERIES

Electrical Characteristics ($T_A = 25^\circ\text{C}$ unless otherwise noted)

PARAMETER	SYMBOL	TEST CONDITION	MIN.	TYP.	MAX.	UNITS
Forward Voltage	V_F	$I_F = 1\text{ mA}, T_J = 25^\circ\text{C}$	-	-	0.32	V
		$I_F = 100\text{ mA}, T_J = 25^\circ\text{C}$	-	-	0.60	
		$I_F = 1\text{ mA}, T_J = 125^\circ\text{C}$	-	0.14	-	
		$I_F = 100\text{ mA}, T_J = 125^\circ\text{C}$	-	0.47	-	
Reverse Current	$I_R^{(2)}$	$V_R = 24\text{ V}, T_J = 25^\circ\text{C}$	-	0.1	-	uA
		$V_R = 30\text{ V}, T_J = 25^\circ\text{C}$	-	-	2	
		$V_R = 30\text{ V}, T_J = 125^\circ\text{C}$	-	90	-	

NOTES:

1. Mounted on a FR4 PCB, single-sided copper, mini pad.
2. Short duration pulse test used to minimize self-heating effect



BAT54W-AU SERIES

TYPICAL CHARACTERISTIC CURVES

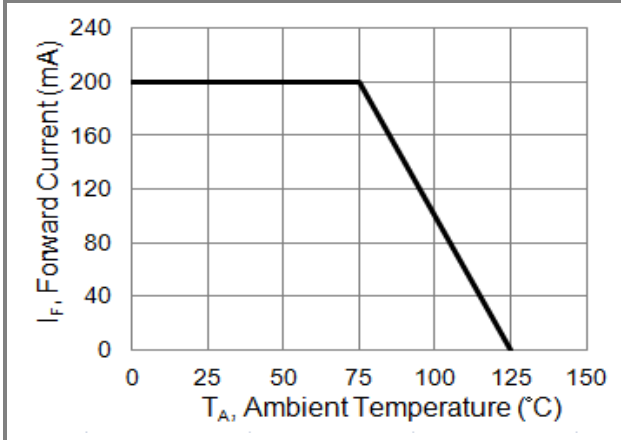

Fig.1 Forward Current Derating Curve

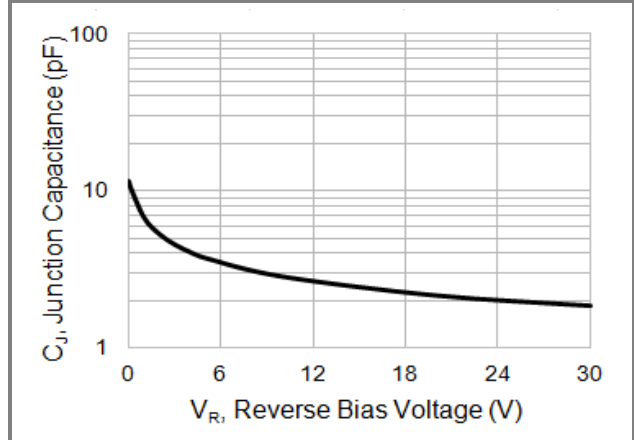

Fig.2 Typical Junction Capacitance

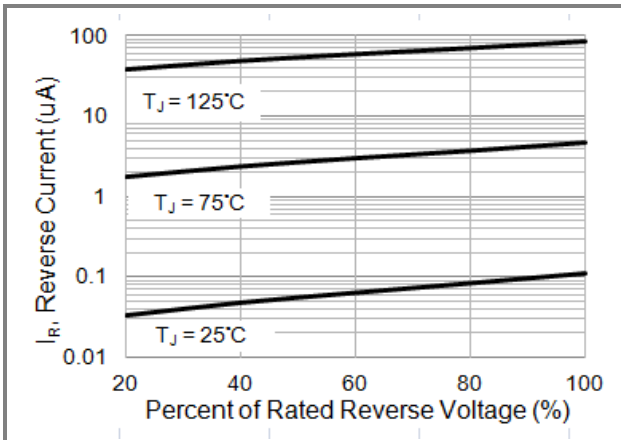

Fig.3 Typical Reverse Characteristics

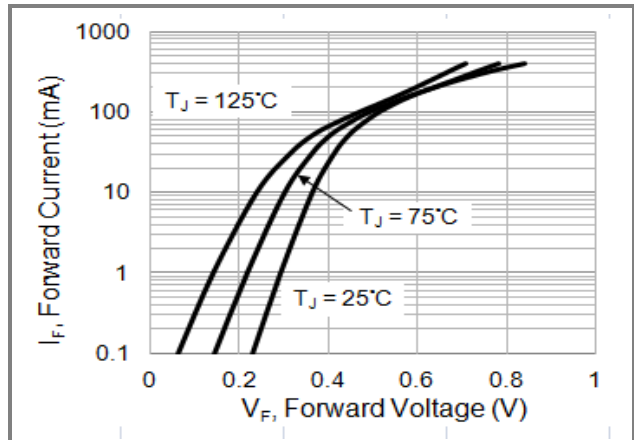

Fig.4 Typical Forward Characteristics

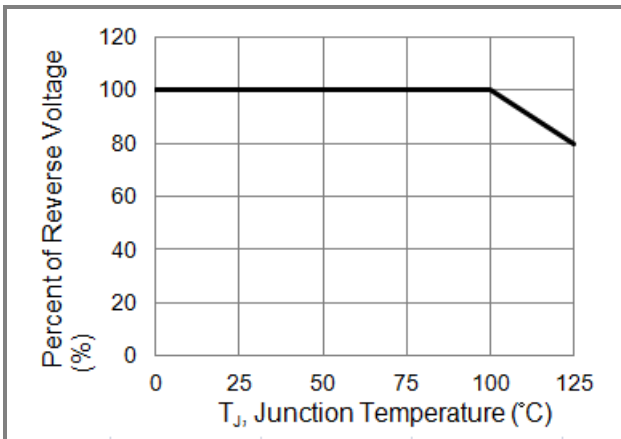

Fig.5 Operating Temperature Derating Curve



BAT54W-AU SERIES

Part No Packing Code Version

Part No Packing Code	Package Type	Packing Type	Marking	Version
BAT54W-AU_R1_000A1	SOT-323	3K / 7" Reel	L4	Halogen free
BAT54AW-AU_R1_000A1	SOT-323	3K / 7" Reel	L42	Halogen free
BAT54CW-AU_R1_000A1	SOT-323	3K / 7" Reel	L43	Halogen free
BAT54SW-AU_R1_000A1	SOT-323	3K / 7" Reel	L44	Halogen free

Packaging Information & Mounting Pad Layout

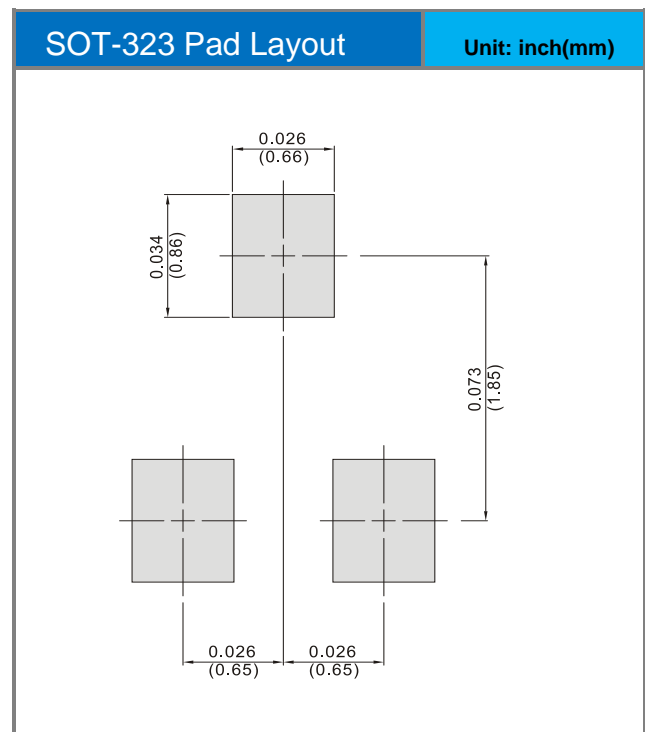
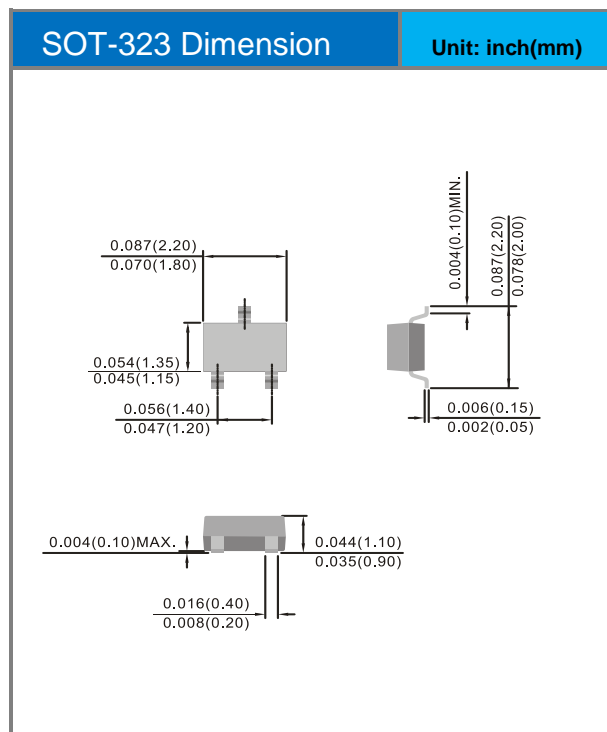



BAT54W-AU SERIES

Disclaimer

- Reproducing and modifying information of the document is prohibited without permission from Panjit International Inc..
- Panjit International Inc. reserves the rights to make changes of the content herein the document anytime without notification. Please refer to our website for the latest document.
- Panjit International Inc. disclaims any and all liability arising out of the application or use of any product including damages incidentally and consequentially occurred.
- Panjit International Inc. does not assume any and all implied warranties, including warranties of fitness for particular purpose, non-infringement and merchantability.
- Applications shown on the herein document are examples of standard use and operation. Customers are responsible in comprehending the suitable use in particular applications. Panjit International Inc. makes no representation or warranty that such applications will be suitable for the specified use without further testing or modification.
- The products shown herein are not designed and authorized for equipments relating to human life and for any applications concerning life-saving or life-sustaining, such as medical instruments, aerospace machinery et cetera. Customers using or selling these products for use in such applications do so at their own risk and agree to fully indemnify Panjit International Inc. for any damages resulting from such improper use or sale.
- Since Panjit uses lot number as the tracking base, please provide the lot number for tracking when complaining.

X-ON Electronics

Largest Supplier of Electrical and Electronic Components

Click to view similar products for [Schottky Diodes & Rectifiers](#) category:

Click to view products by [Panjit](#) manufacturer:

Other Similar products are found below :

[MA4E2039](#) [D1FH3-5063](#) [MBR0530L-TP](#) [MBR10100CT-BP](#) [MBR1545CT](#) [MMBD301M3T5G](#) [RB160M-50TR](#) [RB551V-30](#)
[BAS16E6433HTMA1](#) [BAT 54-02LRH E6327](#) [NSR05F40QNXT5G](#) [JANS1N6640](#) [SB07-03C-TB-H](#) [SB1003M3-TL-W](#) [SK310-T](#) [SK32A-](#)
[LTP](#) [SK34B-TP](#) [SS3003CH-TL-E](#) [GA01SHT18](#) [CRS10I30A\(TE85L,QM](#) [MA4E2501L-1290](#) [MBRB30H30CT-1G](#) [SB007-03C-TB-E](#)
[SK32A-TP](#) [SK33B-TP](#) [SK38B-TP](#) [NRVBM120LT1G](#) [NTE505](#) [NTSB30U100CT-1G](#) [SS15E-TP](#) [ACDBA1100LR-HF](#) [ACDBA1200-HF](#)
[ACDBA140-HF](#) [ACDBA2100-HF](#) [ACDBA3100-HF](#) [CDBQC0530L-HF](#) [CDBQC0240LR-HF](#) [ACDBA260LR-HF](#) [ACDBA1100-HF](#)
[SK310B-TP](#) [MA4E2502L-1246](#) [MA4E2502H-1246](#) [NRVBM120ET1G](#) [NSR01L30MXT5G](#) [SB560](#) [PMAD1108-LF](#) [SD103ATW-TP](#)
[1N5819T-G](#) [PDS1040Q-13](#) [MBR3060FCTe3/TU](#)