



ER500~ER506

GLASS PASSIVATED JUNCTION SUPERFAST RECOVERY RECTIFIERS

VOLTAGE 50 to 600 Volts **CURRENT** 5.0 Amperes

DO-201AD

Unit: inch(mm)

FEATURES

- Superfast recovery times-epitaxial construction.
- Low forward voltage, high current capability.
- Exceeds environmental standards of MIL-S-19500/228.
- Hermetically sealed.
- Low leakage.
- High surge capability.
- Plastic package has Underwriters Laboratories Flammability Classification 94V-O utilizing Flame Retardant Epoxy Molding Compound.
- Lead free in compliance with EU RoHS 2011/65/EU directive

MECHANICAL DATA

- Case: Molded plastic, DO-201AD
- Terminals: Axial leads, solderable to MIL-STD-750, Method 2026
- Polarity: Color Band denotes cathode end
- Mounting Position: Any
- Weight: 0.0395 ounce, 1.122 gram

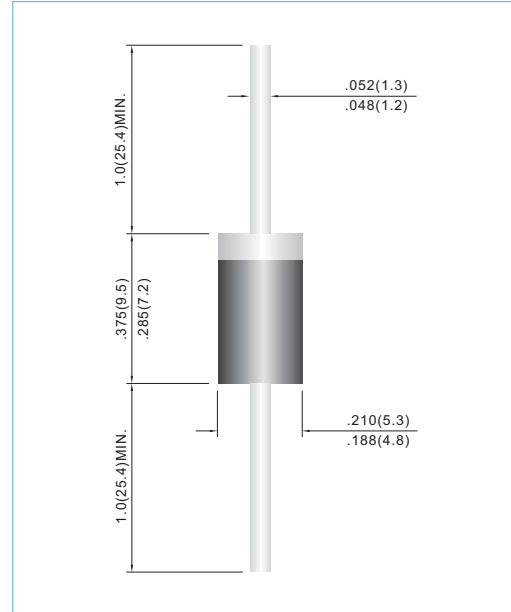

MAXIMUM RATINGS AND ELECTRICAL CHARACTERISTICS

Ratings at 25°C ambient temperature unless otherwise specified. Resistive or inductive load, 60Hz.

| PARAMETER | SYMBOL | ER500 | ER501 | ER501A | ER502 | ER503 | ER504 | ER506 | UNITS |
|--|-----------------|-------------|-------|--------|------------|-------|-------|-------|-----------------------------|
| Maximum Recurrent Peak Reverse Voltage | V_{RRM} | 50 | 100 | 150 | 200 | 300 | 400 | 600 | V |
| Maximum RMS Voltage | V_{RMS} | 35 | 70 | 105 | 140 | 210 | 280 | 420 | V |
| Maximum DC Blocking Voltage | V_{DC} | 50 | 100 | 150 | 200 | 300 | 400 | 600 | V |
| Maximum Average Forward Current .375" (9.5mm) lead length at $T_A=55^\circ\text{C}$ | $I_{F(AV)}$ | 5.0 | | | | | | | A |
| Peak Forward Surge Current : 8.3ms single half sine-wave superimposed on rated load(JEDEC method) | I_{FSM} | 150 | | | | | | | A |
| Maximum Forward Voltage at 5.0A | V_F | 0.95 | | | 1.25 | | 1.70 | | V |
| Maximum DC Reverse Current $T_J=25^\circ\text{C}$ at Rated DC Blocking Voltage $T_J=125^\circ\text{C}$ | I_R | | | | 1.0 300 | | | | μA |
| Maximum Reverse Recovery Time(Note 1) | t_{rr} | | | | 35 | | | | ns |
| Typical Junction capacitance (Note 2) | C_J | | | | 65 | | | | pF |
| Typical Junction Resistance(Note 3) | $R_{\theta JA}$ | | | | 20 | | | | $^\circ\text{C} / \text{W}$ |
| Operating and Storage Temperature Range | T_J, T_{STG} | -55 to +150 | | | | | | | $^\circ\text{C}$ |

NOTES:1. Reverse Recovery Test Conditions: $I_F=5A, I_R=1A, I_{rr}=25A$

2. Measured at 1 MHz and applied reverse voltage of 4.0 VDC

3. Thermal resistance from junction to ambient and from junction to lead length 0.375"(9.5mm) P.C.B. mounted



ER500~ER506

RATING AND CHARACTERISTIC CURVES

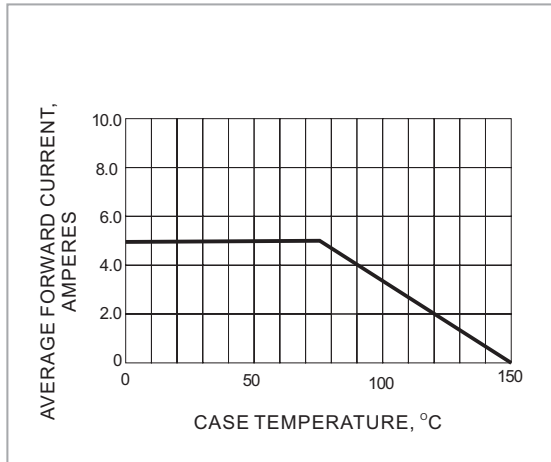

Fig.1-FORWARD CURRENT DERATING CURVE

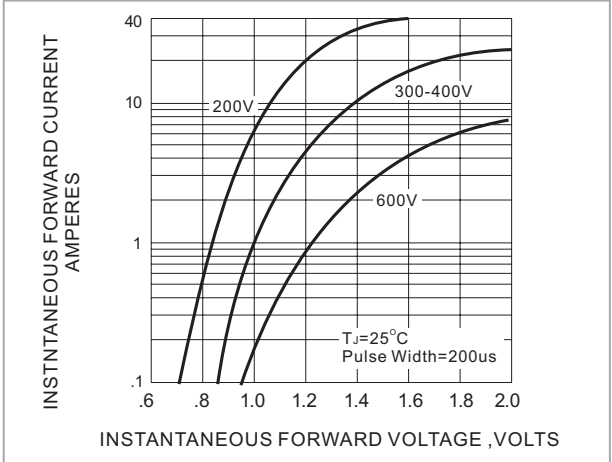

Fig.2-TYPICAL INSTANTANEOUS FORWARD CHARACTERISTIC

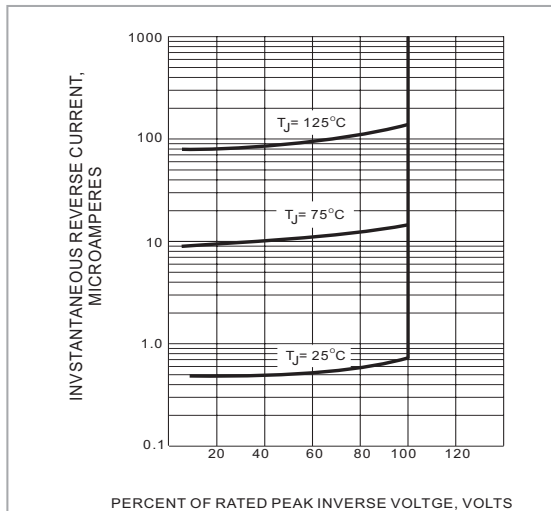

Fig.3-TYPICAL REVERSE CHARACTERISTICS

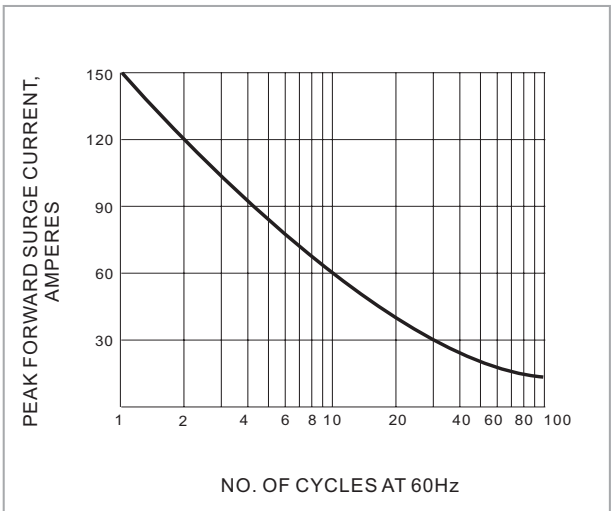

Fig.4-MAXIMUM NON-REPETITIVE SURGE CURRENT

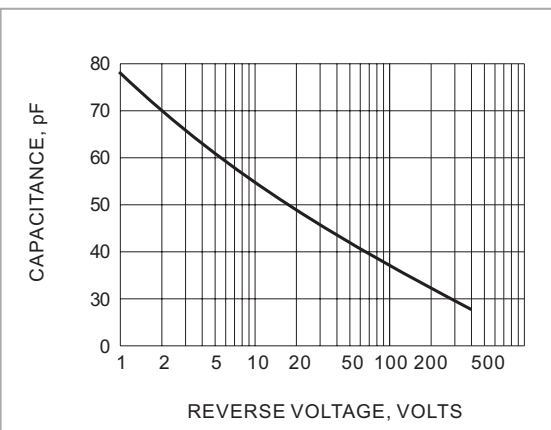

Fig.5-TYPICAL JUNCTION CAPACITANCE



ER500~ER506

Part No_packing code_Version

ER500_AY_00001
ER500_AY_10001
ER500_B0_00001
ER500_B0_10001
ER500_R2_00001
ER500_R2_10001

For example :

RB500V-40_R2_00001

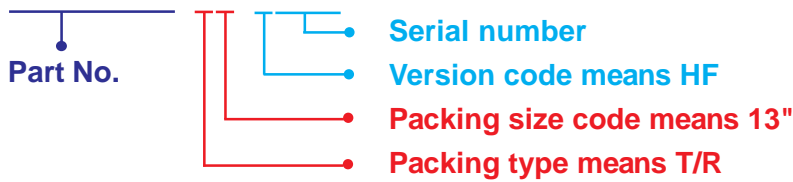

| Packing Code XX | | | | Version Code XXXXX | | |
|--------------------------------------|----------------------|----------------------------------|----------------------|---------------------------|----------------------|---------------------------------------|
| Packing type | 1 st Code | Packing size code | 2 nd Code | HF or RoHS | 1 st Code | 2 nd ~5 th Code |
| Tape and Ammunition Box (T/B) | A | N/A | 0 | HF | 0 | serial number |
| Tape and Reel (T/R) | R | 7" | 1 | RoHS | 1 | serial number |
| Bulk Packing (B/P) | B | 13" | 2 | | | |
| Tube Packing (T/P) | T | 26mm | X | | | |
| Tape and Reel (Right Oriented) (TRR) | S | 52mm | Y | | | |
| Tape and Reel (Left Oriented) (TRL) | L | PANASERT T/B CATHODE UP (PBCU) | U | | | |
| FORMING | F | PANASERT T/B CATHODE DOWN (PBCD) | D | | | |



ER500~ER506

Disclaimer

- Reproducing and modifying information of the document is prohibited without permission from Panjit International Inc..
- Panjit International Inc. reserves the rights to make changes of the content herein the document anytime without notification. Please refer to our website for the latest document.
- Panjit International Inc. disclaims any and all liability arising out of the application or use of any product including damages incidentally and consequentially occurred.
- Panjit International Inc. does not assume any and all implied warranties, including warranties of fitness for particular purpose, non-infringement and merchantability.
- Applications shown on the herein document are examples of standard use and operation. Customers are responsible in comprehending the suitable use in particular applications. Panjit International Inc. makes no representation or warranty that such applications will be suitable for the specified use without further testing or modification.
- The products shown herein are not designed and authorized for equipments requiring high level of reliability or relating to human life and for any applications concerning life-saving or life-sustaining, such as medical instruments, transportation equipment, aerospace machinery et cetera. Customers using or selling these products for use in such applications do so at their own risk and agree to fully indemnify Panjit International Inc. for any damages resulting from such improper use or sale.
- Since Panjit uses lot number as the tracking base, please provide the lot number for tracking when complaining.

X-ON Electronics

Largest Supplier of Electrical and Electronic Components

Click to view similar products for [Rectifiers](#) category:

Click to view products by [Panjit](#) manufacturer:

Other Similar products are found below :

[70HFR40](#) [RL252-TP](#) [150KR30A](#) [1N5397](#) [SCF5000](#) [1N4002G](#) [1N4005-TR](#) [JANS1N6640US](#) [481235F](#) [RRE02VS6SGTR](#) [067907F](#) [MS306](#)
[70HF40](#) [T85HFL60S02](#) [US2JFL-TP](#) [A1N5404G-G](#) [ACGRA4007-HF](#) [ACGRB207-HF](#) [CLH03\(TE16L,Q\)](#) [ACGRC307-HF](#) [ACEFC304-HF](#)
[85HFR60](#) [40HFR60](#) [70HF120](#) [85HFR80](#) [D126A45C](#) [SCF7500](#) [D251N08B](#) [SCHJ22.5K](#) [SM100](#) [SCPA2](#) [SCH10000](#) [SDHD5K](#) [VS-](#)
[12FL100S10](#) [ACGRA4001-HF](#) [D1821SH45T PR](#) [D1251S45T](#) [SKN300/16](#) [SKN 5/08](#) [TSD3G](#) [SET130312](#) [MSE07PBHM3/89A](#) [UES1106](#)
[60S8-TP](#) [NTE6010](#) [JANTX1N5196](#) [SCHS15000](#) [BYV32-200M](#) [D5FE60-5063](#) [JANS1N6621US](#)