



PJD50N10AL

100V N-Channel Enhancement Mode MOSFET

Voltage

100 V

Current

42 A

Features

- $R_{DS(ON)}$, $V_{GS}@10V$, $I_D@20A < 25m\Omega$
- $R_{DS(ON)}$, $V_{GS}@4.5V$, $I_D@15A < 28.5m\Omega$
- Advanced Trench Process Technology
- High density cell design for ultra low on-resistance
- Lead free in compliance with EU RoHS 2011/65/EU directive
- Green molding compound as per IEC61249 Std.. (Halogen Free)

Mechanical Data

- Case : TO-252AA Package
- Terminals : Solderable per MIL-STD-750, Method 2026
- Approx. Weight : 0.0104 ounces, 0.297grams

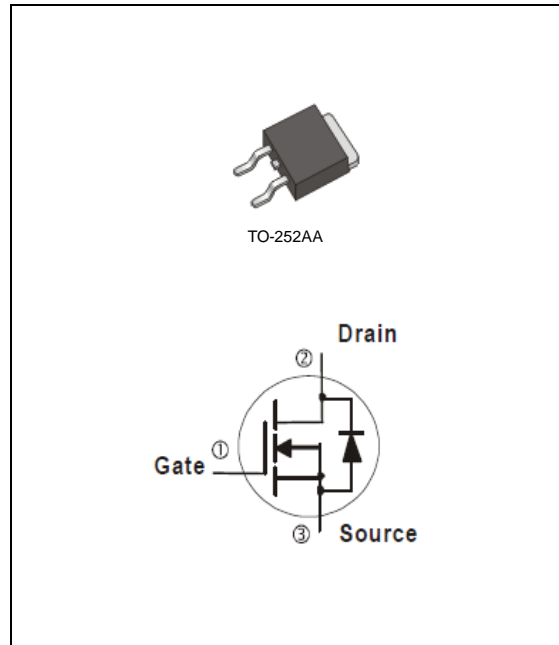

Maximum Ratings and Thermal Characteristics ($T_A=25^\circ C$ unless otherwise noted)

PARAMETER		SYMBOL	LIMIT	UNITS
Drain-Source Voltage		V_{DS}	100	V
Gate-Source Voltage		V_{GS}	± 20	V
Continuous Drain Current	$T_C=25^\circ C$	I_D	42	A
	$T_C=100^\circ C$		26	
Pulsed Drain Current (Note 1)	$T_C=25^\circ C$	I_{DM}	150	
Power Dissipation	$T_C=25^\circ C$	P_D	83	W
	$T_C=100^\circ C$		33	
Continuous Drain Current	$T_A=25^\circ C$	I_D	6.3	A
	$T_A=70^\circ C$		5.1	A
Power Dissipation	$T_A=25^\circ C$	P_D	2.0	W
Power Dissipation	$T_A=70^\circ C$		1.3	
Single Pulse Avalanche Energy (Note 6)		E_{AS}	63.4	mJ
Operating Junction and Storage Temperature Range		T_J, T_{STG}	-55~150	$^\circ C$
Typical Thermal Resistance (Note 4,5)	Junction to Case	$R_{\theta JC}$	1.5	$^\circ C/W$
	Junction to Ambient	$R_{\theta JA}$	62.5	

- Limited only By Maximum Junction Temperature



PJD50N10AL

Electrical Characteristics (T_A=25°C unless otherwise noted)

PARAMETER	SYMBOL	TEST CONDITION	MIN.	TYP.	MAX.	UNITS
Static						
Drain-Source Breakdown Voltage	BV _{DSS}	V _{GS} =0V, I _D =250uA	100	-	-	V
Gate Threshold Voltage	V _{GS(th)}	V _{DS} =V _{GS} , I _D =250uA	1.0	1.8	2.5	V
Drain-Source On-State Resistance	R _{DS(on)}	V _{GS} =10V, I _D =20A	-	20	25	mΩ
		V _{GS} =4.5V, I _D =15A	-	22	28.5	
Zero Gate Voltage Drain Current	I _{DSS}	V _{DS} =80V, V _{GS} =0V	-	-	1.0	uA
Gate-Source Leakage Current	I _{GSS}	V _{GS} =±20V, V _{DS} =0V	-	-	±100	nA
Dynamic (Note 7)						
Total Gate Charge	Q _g	V _{DS} =50V, I _D =10A, V _{GS} =10V (Note 1,2)	-	29	-	nC
Gate-Source Charge	Q _{gs}		-	4.5	-	
Gate-Drain Charge	Q _{gd}		-	6.4	-	
Input Capacitance	C _{iss}	V _{DS} =30V, V _{GS} =0V, f=1.0MHZ	-	1485	-	pF
Output Capacitance	C _{oss}		-	135	-	
Reverse Transfer Capacitance	C _{rss}		-	67	-	
Turn-On Delay Time	t _{d(on)}	V _{DD} =50V, I _D =10A, V _{GS} =10V, R _G =3Ω (Note 1,2)	-	7.8	-	ns
Turn-On Rise Time	t _r		-	30	-	
Turn-Off Delay Time	t _{d(off)}		-	35	-	
Turn-Off Fall Time	t _f		-	14	-	
Drain-Source Diode						
Maximum Continuous Drain-Source Diode Forward Current	I _S	---	-	-	42	A
Diode Forward Voltage	V _{SD}	I _S =1.0A, V _{GS} =0V	-	0.7	1.2	V

NOTES :

1. Pulse width ≤ 300us, Duty cycle ≤ 2%
2. Essentially independent of operating temperature typical characteristics.
3. Repetitive rating, pulse width limited by junction temperature T_J(MAX)=150°C. Ratings are based on low frequency and duty cycles to keep initial T_J = 25°C.
4. The maximum current rating is package limited.
5. R_{θJA} is the sum of the junction-to-case and case-to-ambient thermal resistance where the case thermal reference is defined as the solder mounting surface of the drain pins. Mounted on a 1 inch² with 2oz. square pad of copper.
6. The test condition is L=3mH, I_{AS}=6.5A, V_{DD}=25V, V_{GS}=10V
7. Guaranteed by design, not subject to production testing.



PJD50N10AL

TYPICAL CHARACTERISTIC CURVES

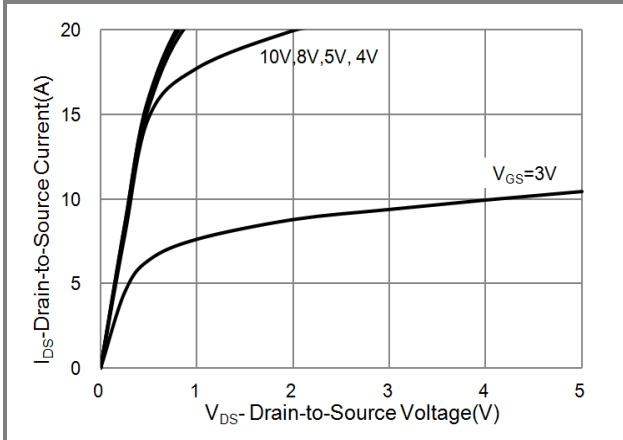

Fig.1 Output Characteristics

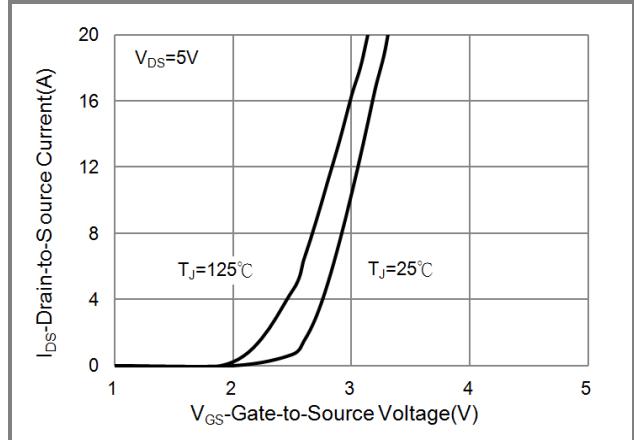

Fig.2 Transfer Characteristics

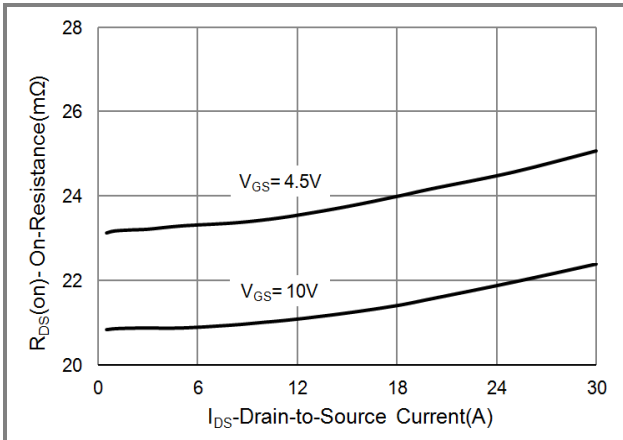

Fig.3 On-Resistance vs. Drain Current

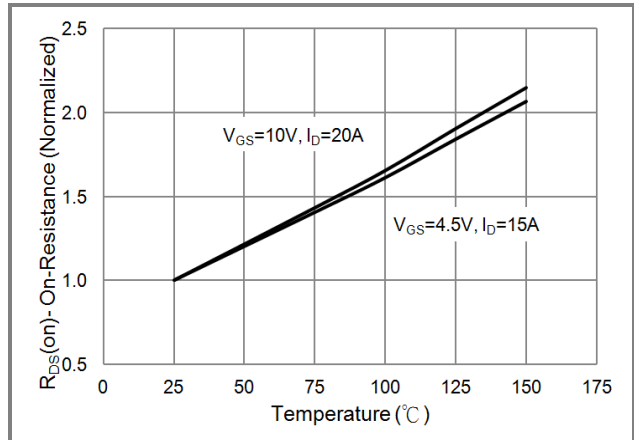

Fig.4 On-Resistance vs. Junction temperature

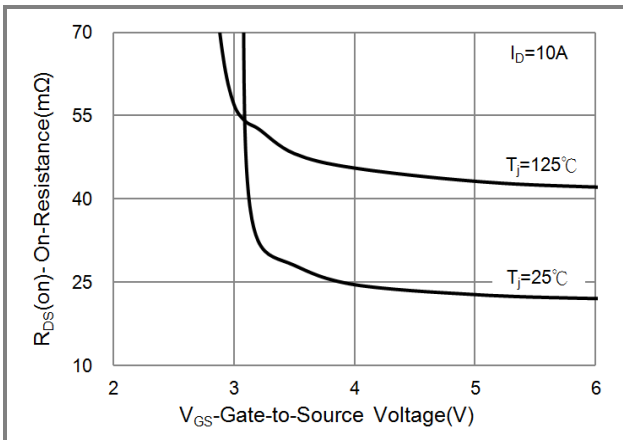

Fig.5 On-Resistance Variation with VGS.

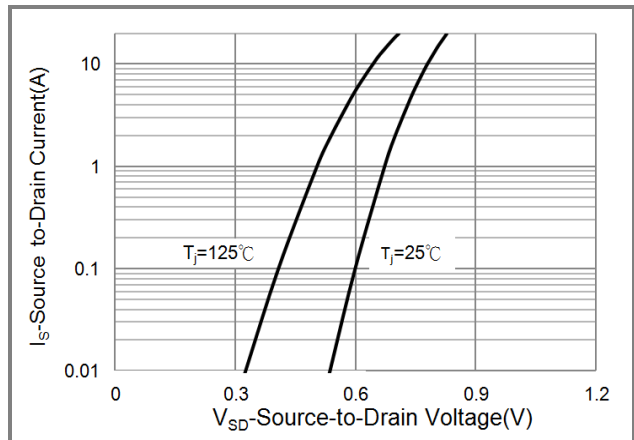

Fig.6 Source-Drain Diode Forward Voltage



PJD50N10AL

TYPICAL CHARACTERISTIC CURVES

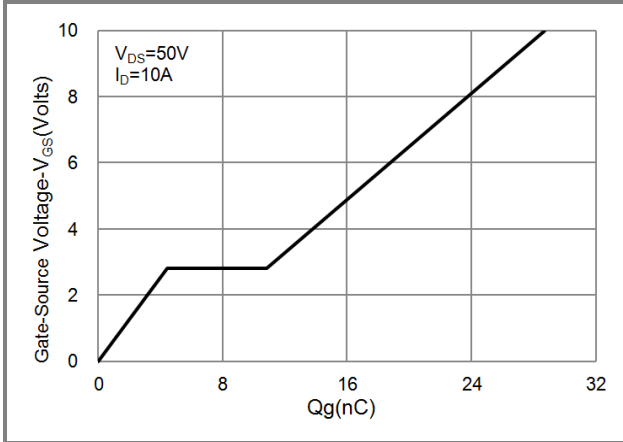

Fig.7 Gate-Charge Characteristics

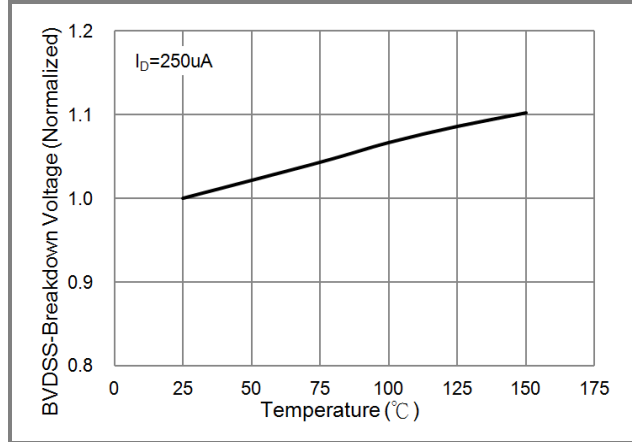

Fig.8 Breakdown Voltage Variation vs. Temperature

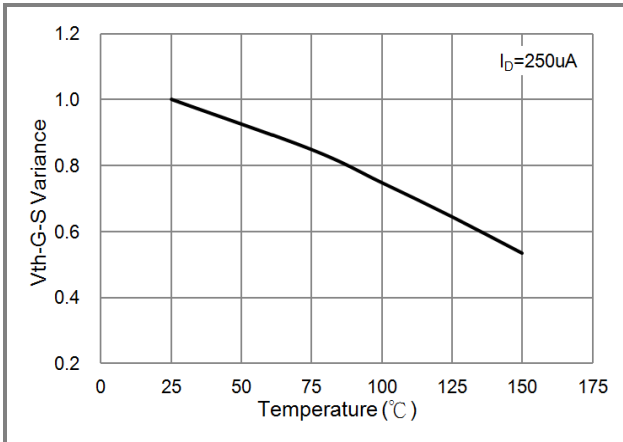

Fig.9 Threshold Voltage Variation with Temperature

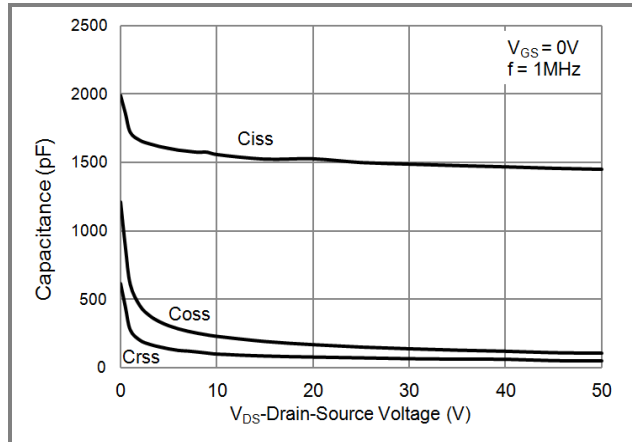

Fig.10 Capacitance vs. Drain-Source Voltage

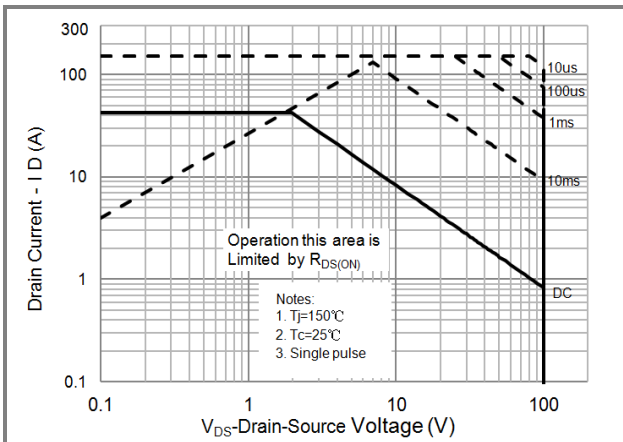
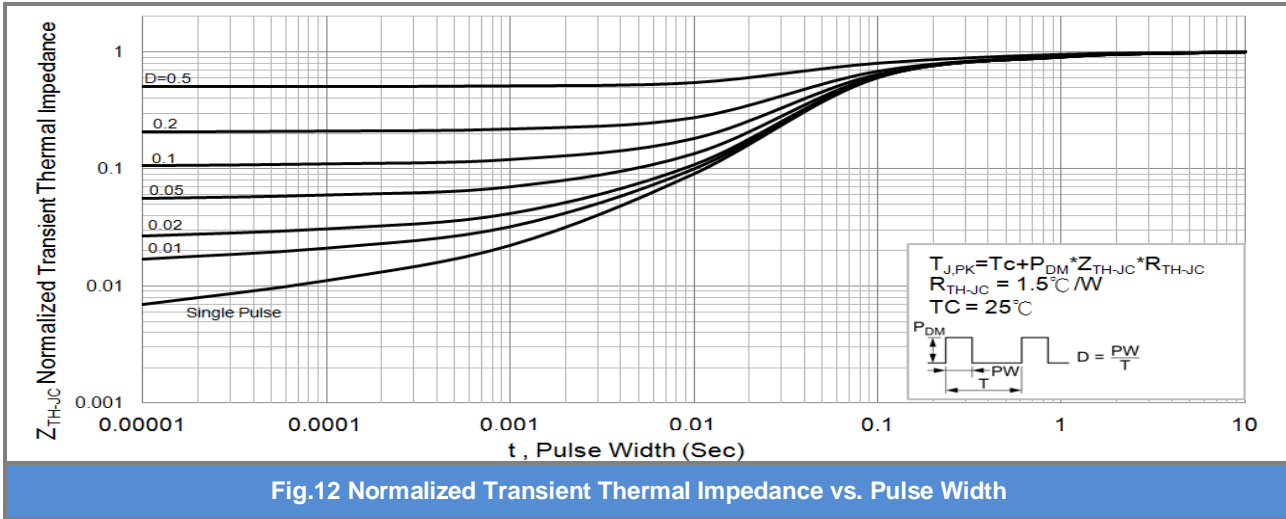

Fig.11 Maximum Safe Operating Area



PJD50N10AL

TYPICAL CHARACTERISTIC CURVES





PJD50N10AL

Packaging Information

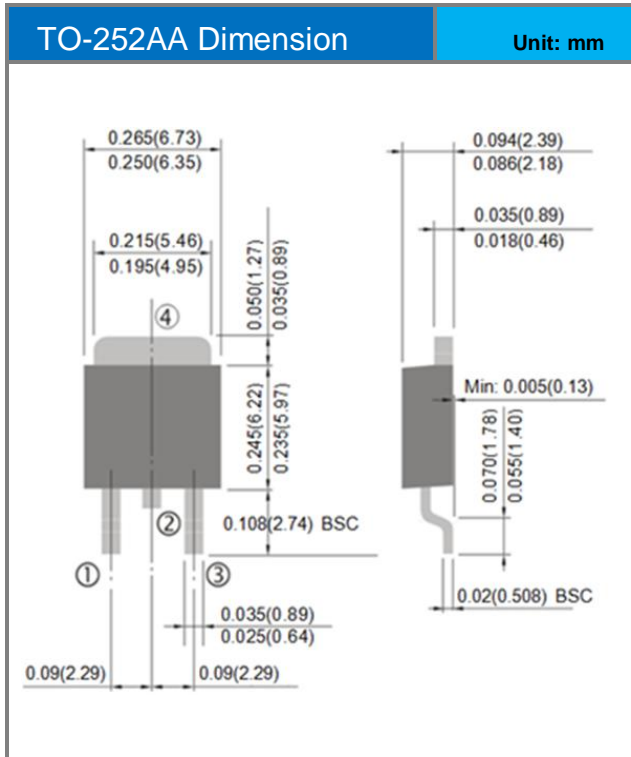



PJD50N10AL

PART NO PACKING CODE VERSION

Part No Packing Code	Package Type	Packing Type	Marking	Version
PJD50N10AL_L2_00001	TO-252AA	3,000pcs / 13" reel	50N10AL	Halogen free

MOUNTING PAD LAYOUT

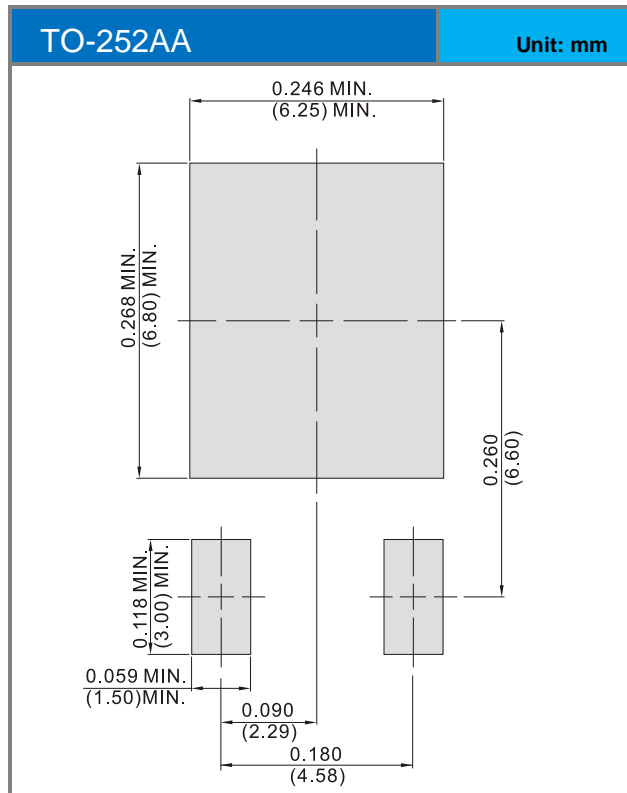



PJD50N10AL

Disclaimer

- Reproducing and modifying information of the document is prohibited without permission from Panjit International Inc..
- Panjit International Inc. reserves the rights to make changes of the content herein the document anytime without notification. Please refer to our website for the latest document.
- Panjit International Inc. disclaims any and all liability arising out of the application or use of any product including damages incidentally and consequentially occurred.
- Panjit International Inc. does not assume any and all implied warranties, including warranties of fitness for particular purpose, non-infringement and merchantability.
- Applications shown on the herein document are examples of standard use and operation. Customers are responsible in comprehending the suitable use in particular applications. Panjit International Inc. makes no representation or warranty that such applications will be suitable for the specified use without further testing or modification.
- The products shown herein are not designed and authorized for equipments requiring high level of reliability or relating to human life and for any applications concerning life-saving or life-sustaining, such as medical instruments, transportation equipment, aerospace machinery et cetera. Customers using or selling these products for use in such applications do so at their own risk and agree to fully indemnify Panjit International Inc. for any damages resulting from such improper use or sale.
- Since Panjit uses lot number as the tracking base, please provide the lot number for tracking when complaining.

X-ON Electronics

Largest Supplier of Electrical and Electronic Components

Click to view similar products for [MOSFET](#) category:

Click to view products by [Panjit](#) manufacturer:

Other Similar products are found below :

[614233C](#) [648584F](#) [MCH3443-TL-E](#) [MCH6422-TL-E](#) [FDPF9N50NZ](#) [FW216A-TL-2W](#) [FW231A-TL-E](#) [APT5010JVR](#) [NTNS3A92PZT5G](#)
[IRF100S201](#) [JANTX2N5237](#) [2SK2464-TL-E](#) [2SK3818-DL-E](#) [FCA20N60_F109](#) [FDZ595PZ](#) [STD6600NT4G](#) [FSS804-TL-E](#) [2SJ277-DL-E](#)
[2SK1691-DL-E](#) [2SK2545\(Q,T\)](#) [D2294UK](#) [405094E](#) [423220D](#) [MCH6646-TL-E](#) [TPCC8103,L1Q\(CM](#) [367-8430-0972-503](#) [VN1206L](#)
[424134F](#) [026935X](#) [051075F](#) [SBVS138LT1G](#) [614234A](#) [715780A](#) [NTNS3166NZT5G](#) [751625C](#) [873612G](#) [IRF7380TRHR](#)
[IPS70R2K0CEAKMA1](#) [RJK60S3DPP-E0#T2](#) [RJK60S5DPK-M0#T0](#) [APT5010JVFR](#) [APT12031JFLL](#) [APT12040JVR](#) [DMN3404LQ-7](#)
[NTE6400](#) [JANTX2N6796U](#) [JANTX2N6784U](#) [JANTXV2N5416U4](#) [SQM110N05-06L-GE3](#) [SIHF35N60E-GE3](#)