

650V N-Channel Super Junction MOSFET

Voltage	650 V	Rdson	390 mΩ
Current	10 A	Qg	19 nC

Feature:

- $R_{DS(ON) Max, V_{GS}@10V}$: 390mΩ
- Easy to use/ drive
- High Speed Switching and Low $R_{DS(ON)}$
- 100% Avalanche Tested
- 100% Rg Tested
- Lead free in compliance with EU RoHS 2.0
- Green molding compound as per IEC 61249 standard

Mechanical Data

- Case: ITO-220AB-F package
- Terminals: Solderable per MIL-STD-750, Method 2026
- Approx. Weight: 0.068 ounces, 2 grams

Application

- Monitor Power, TV Power, PD Charger

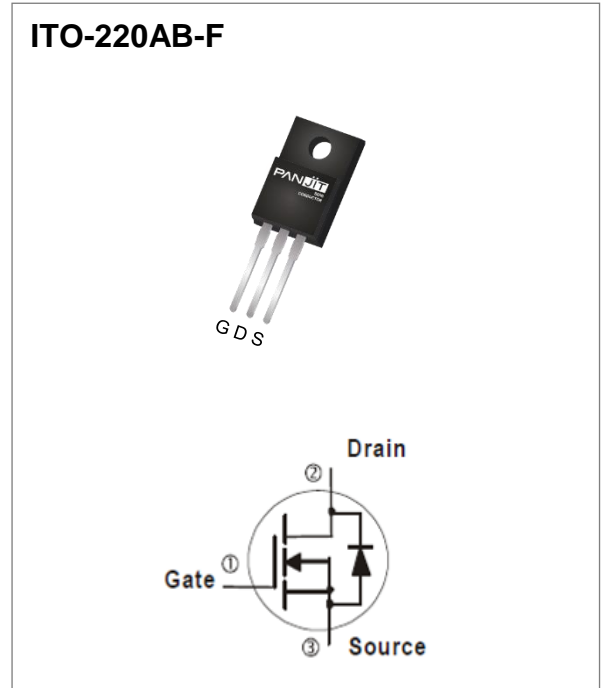

Absolute Maximum Ratings ($T_A = 25^\circ\text{C}$ unless otherwise specified)

PARAMETER		SYMBOL	LIMIT	UNITS
Drain-Source Voltage @ T_{jmax}		V_{DS}	700	V
Drain-Source Voltage		V_{DS}	650	
Gate-Source Voltage		V_{GS}	± 30	
Continuous Drain Current	$T_C=25^\circ\text{C}$	I_D	10	A
	$T_C=100^\circ\text{C}$		6.2	
Pulsed Drain Current	$T_C=25^\circ\text{C}$	I_{DM}	22	A
Single Pulse Avalanche Energy		E_{AS}	220	mJ
MOSFET dv/dt ruggedness		dv/dt	50	V/ns
Power Dissipation	$T_C=25^\circ\text{C}$	P_D	29.5	W
	$T_C=100^\circ\text{C}$		12	
Insulation Withstand Voltage for ITO-220AB-F		V_{ISO}	3.5	kV
Operating Junction and Storage Temperature Range		T_J, T_{STG}	-55~150	$^\circ\text{C}$

Thermal Characteristics

PARAMETER		SYMBOL	MAXIMUM	UNITS
Thermal Resistance	Junction-to-Case	$R_{\theta JC}$	4.2	$^\circ\text{C/W}$
	Junction-to-Ambient (Note 3)	$R_{\theta JA}$	62.5	$^\circ\text{C/W}$

Electrical Characteristics ($T_A = 25\text{ }^\circ\text{C}$ unless otherwise specified)

PARAMETER	SYMBOL	TEST CONDITION	MIN.	TYP.	MAX.	UNITS
Static						
Drain-Source Breakdown Voltage	BV_{DSS}	$V_{GS}=0V, I_D=250\mu A$	650	730	-	V
Gate Threshold Voltage	$V_{GS(th)}$	$V_{DS}=V_{GS}, I_D=250\mu A$	2	3.0	4	
Drain-Source On-State Resistance	$R_{DS(on)}$	$V_{GS}=10V, I_D=5.0A$ (Note 1)	-	340	390	m Ω
Zero Gate Voltage Drain Current	I_{DSS}	$V_{DS}=650V, V_{GS}=0V$	-	-	1	μA
Gate-Source Leakage Current	I_{GSS}	$V_{GS}=\pm 30V, V_{DS}=0V$	-	-	± 100	nA
Transfer characteristics	gfs	$V_{DS}=20V, I_D=11A$	-	10	-	S
Dynamic (Note 5)						
Total Gate Charge	Q_g	$V_{DS}=520V, I_D=11A,$ $V_{GS}=10V$	-	19	-	nC
Gate-Source Charge	Q_{gs}		-	4	-	
Gate-Drain Charge	Q_{gd}		-	8	-	
Input Capacitance	C_{iss}	$V_{DS}=400V, V_{GS}=0V,$ $f=250kHz$	-	726	-	pF
Output Capacitance	C_{oss}		-	29	-	
Reverse Transfer Capacitance	C_{rss}		-	8	-	
Effective Output Capacitance Energy Related	$C_{o(er)}$	$V_{DS}=0V$ to 400V, $V_{GS}=0V, f=250kHz$ (Note 4)	-	37	-	
Turn-On Delay Time	$t_{d(on)}$	$V_{DD}=325V, I_D=11A,$ $V_{GS}=10V, R_G=25\Omega$ (Note 2)	-	30	-	ns
Turn-On Rise Time	t_r		-	50	-	
Turn-Off Delay Time	$t_{d(off)}$		-	87	-	
Turn-Off Fall Time	t_f		-	42	-	
Gate Resistance	R_g	$f=1.0MHz$	-	6.8	-	Ω
Drain-Source Diode						
Maximum Continuous Drain-Source Diode Forward Current	I_S		-	-	10	A
Diode Forward Voltage	V_{SD}	$I_S=10A, V_{GS}=0V$	-	0.89	1.5	V
Reverse Recovery Charge	Q_{rr}	$I_S=11A$	-	3.3	-	μC
Reverse Recovery Time	T_{rr}	$di/dt=100A/\mu s$	-	291	-	ns

NOTES :

1. Pulse width $\leq 300\mu s$, Duty cycle $\leq 2\%$
2. Essentially independent of operating temperature typical characteristics.
3. $R_{\theta JA}$ is the sum of the junction-to-case and case-to-ambient thermal resistance.
4. $C_{o(er)}$ is a capacitance that gives the same stored energy as C_{oss} while V_{DS} is rising from 0V to 80% $V_{(BR)DSS}$
5. Guaranteed by design, not subject to production testing

TYPICAL CHARACTERISTIC CURVES

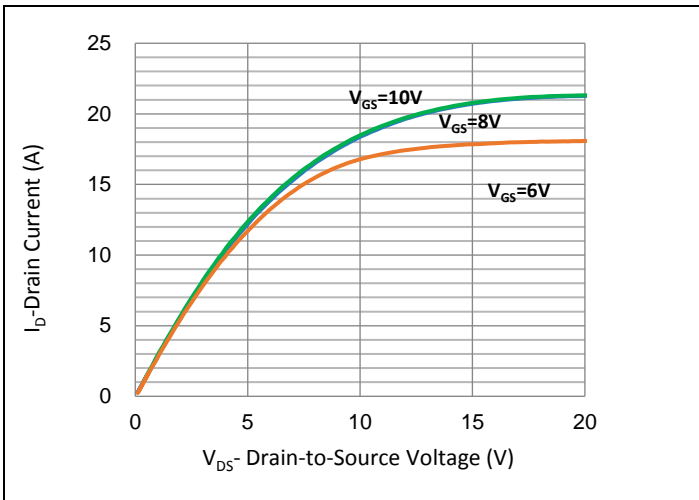

Fig.1 Output Characteristics

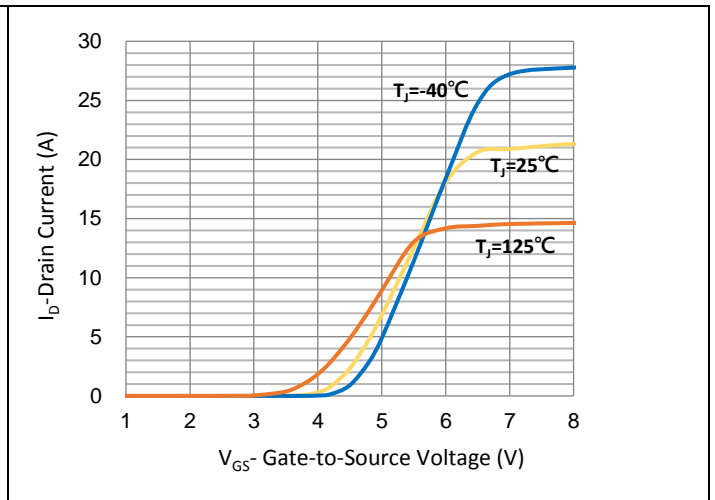

Fig.2 Transfer Characteristics

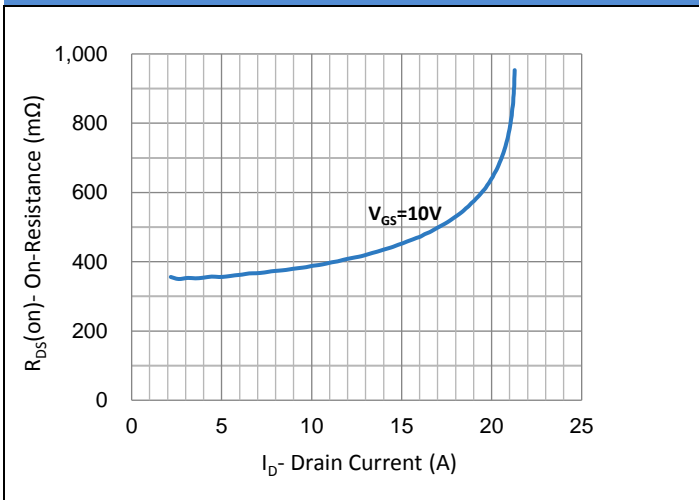

Fig.3 On-Resistance vs. Drain Current

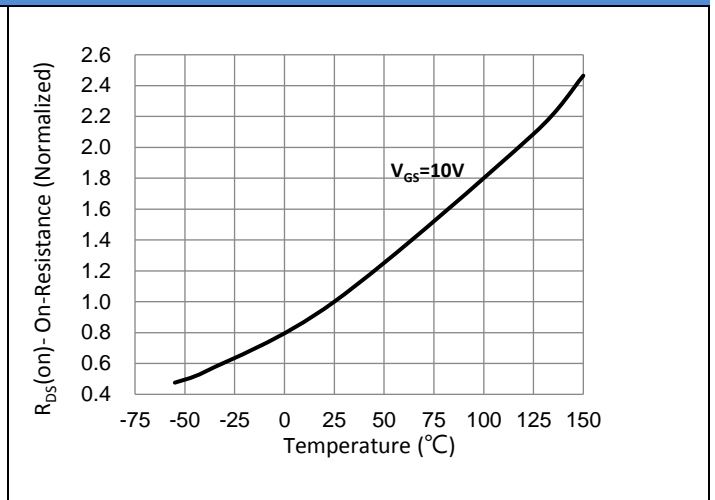

Fig.4 On-Resistance vs. Junction Temperature

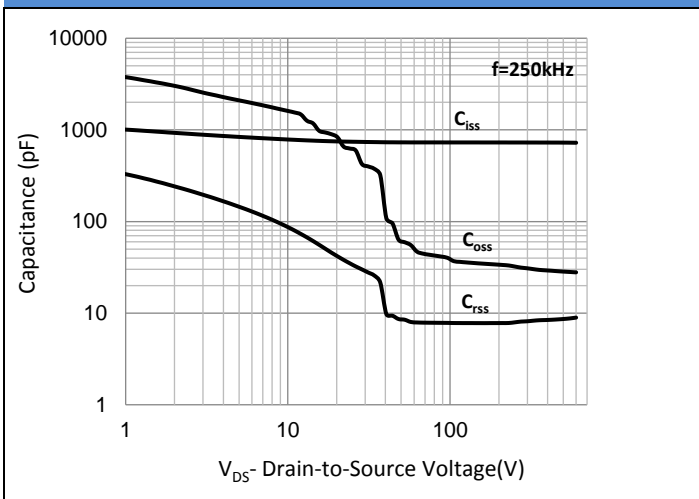

Fig.5 Capacitance vs. Drain-Source Voltage

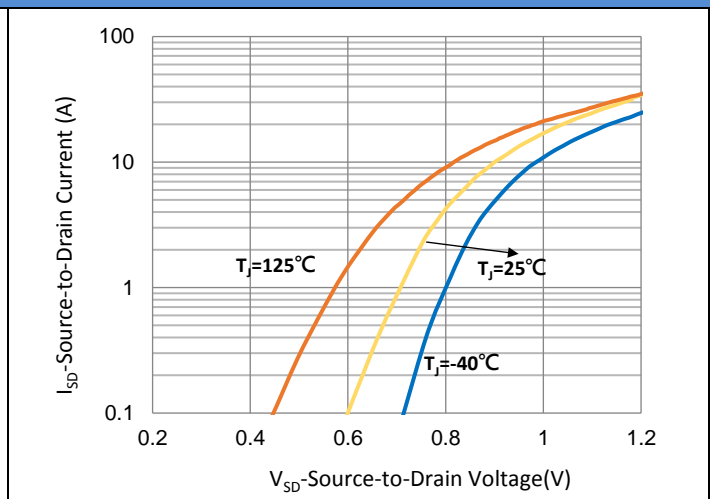

Fig.6 Source-Drain Diode Forward Voltage

TYPICAL CHARACTERISTIC CURVES

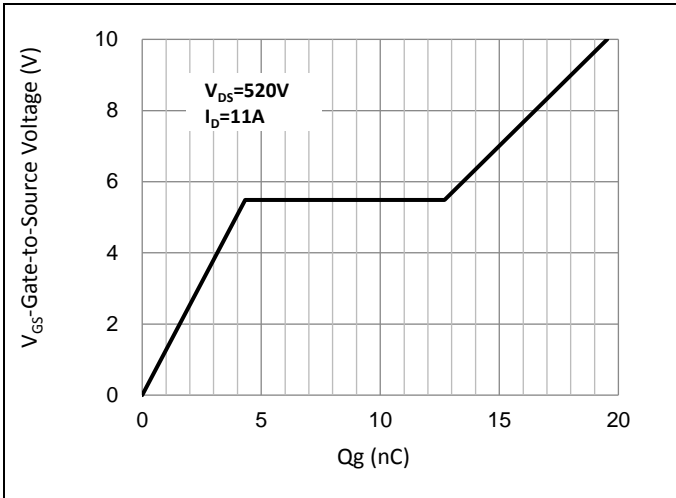

Fig.7 Gate-Charge Characteristics

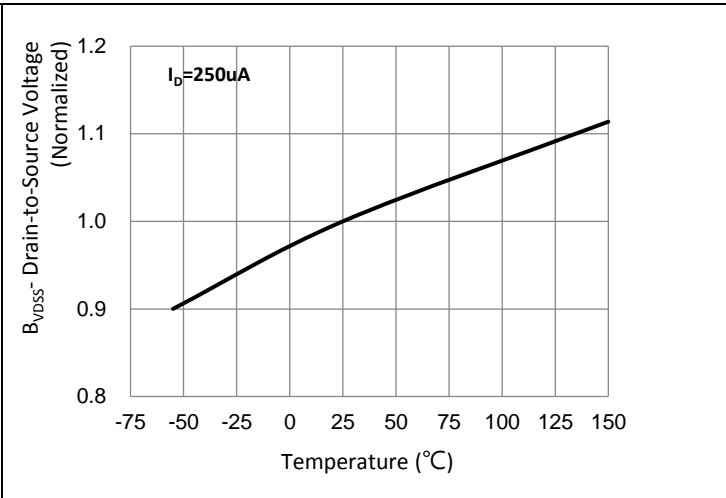

Fig.8 Breakdown Voltage Variation vs. Temperature

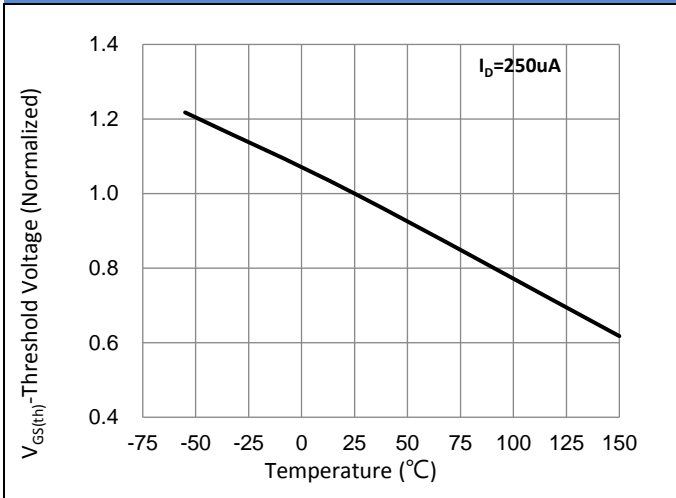

Fig.9 Threshold Voltage Variation with Temperature

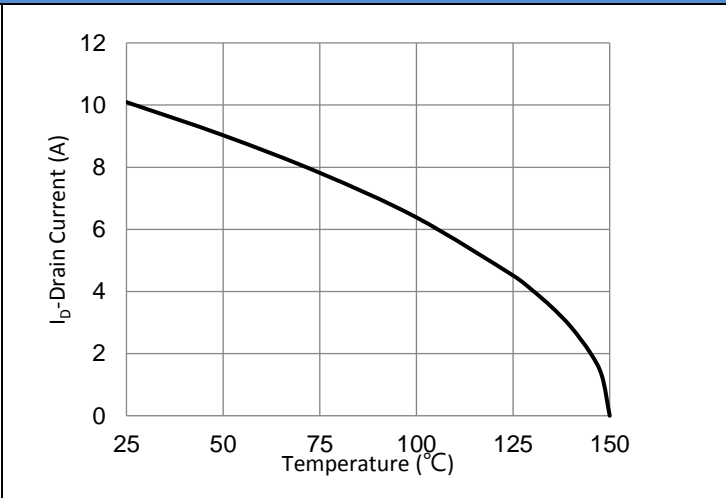

Fig.10 Drain Current vs. Case Temperature

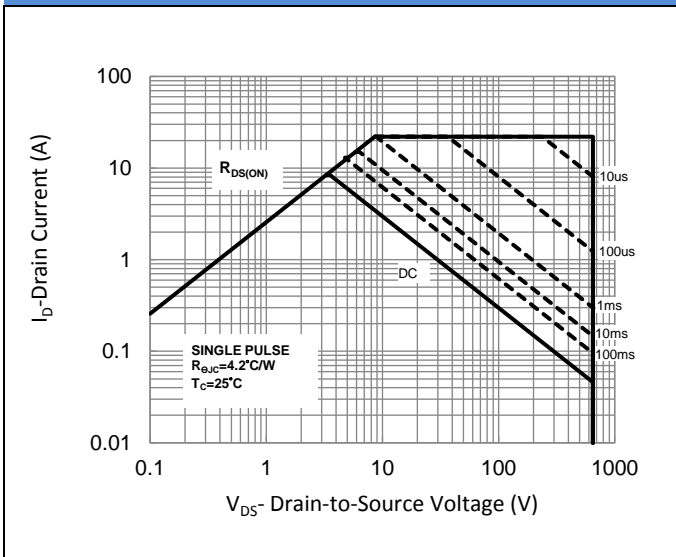

Fig.11 Maximum Safe Operating Area

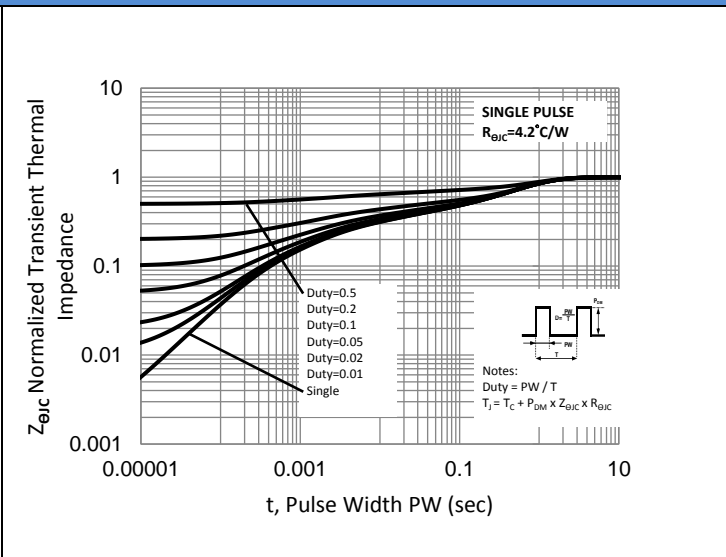

Fig.12 Normalized Transient Thermal Impedance

TYPICAL CHARACTERISTIC CURVES

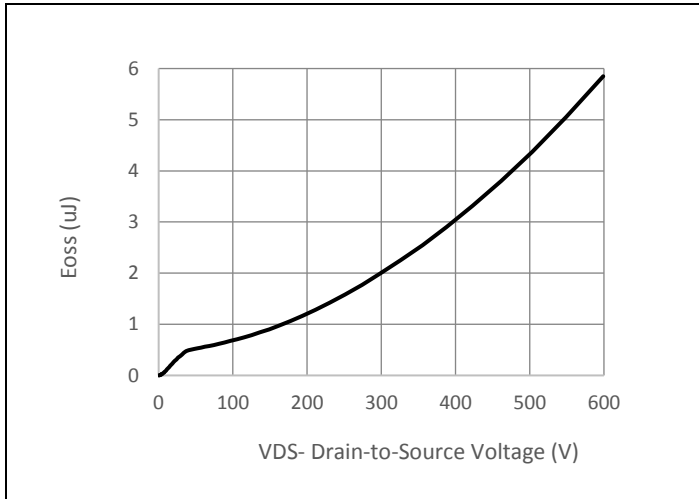
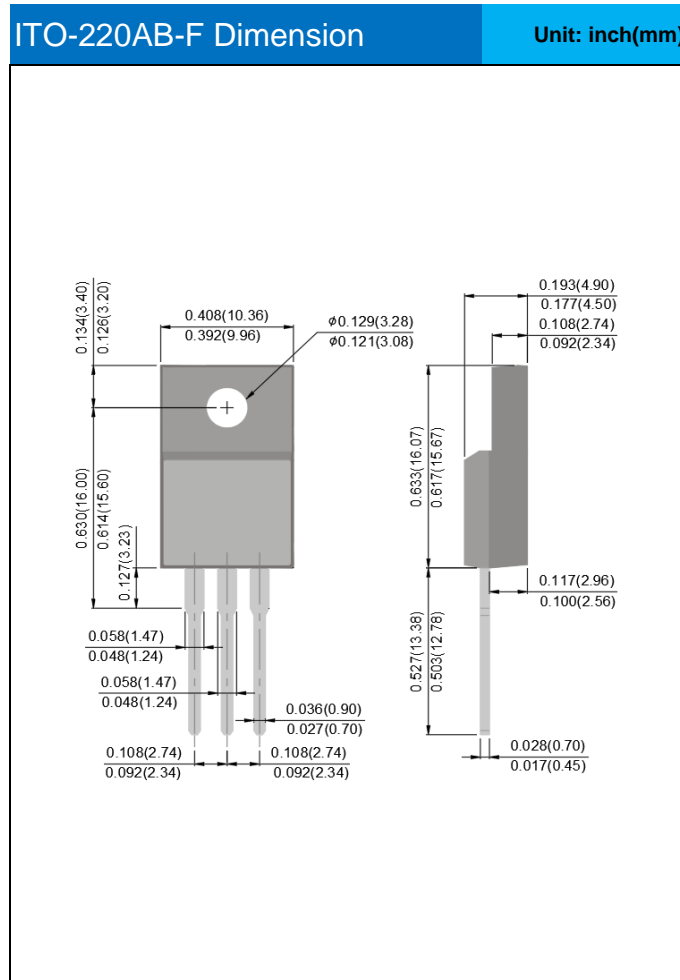

Fig.13 Typ. Coss Stored Energy

Product and Packing Information

Part No.	Package Type	Packing Type	Marking
PJMF390N65EC	ITO-220AB-F	50pcs / Tube	390N65EC

Packaging Information



Marking Diagram

PJ
390N65EC
YWLL x

- Y** = Year Code
- W** = Week Code (A~Z)
- LL** = Lot Code (00~99)
- x** = Production Line Code

Disclaimer

- Reproducing and modifying information of the document is prohibited without permission from Panjit International Inc..
- Panjit International Inc. reserves the rights to make changes of the content herein the document anytime without notification. Please refer to our website for the latest document.
- Panjit International Inc. disclaims any and all liability arising out of the application or use of any product including damages incidentally and consequentially occurred.
- Panjit International Inc. does not assume any and all implied warranties, including warranties of fitness for particular purpose, non-infringement and merchantability.
- Applications shown on the herein document are examples of standard use and operation. Customers are responsible in comprehending the suitable use in particular applications. Panjit International Inc. makes no representation or warranty that such applications will be suitable for the specified use without further testing or modification.
- The products shown herein are not designed and authorized for equipments requiring high level of reliability or relating to human life and for any applications concerning life-saving or life-sustaining, such as medical instruments, transportation equipment, aerospace machinery et cetera. Customers using or selling these products for use in such applications do so at their own risk and agree to fully indemnify Panjit International Inc. for any damages resulting from such improper use or sale.
- Since Panjit uses lot number as the tracking base, please provide the lot number for tracking when complaining.

X-ON Electronics

Largest Supplier of Electrical and Electronic Components

Click to view similar products for [MOSFET](#) category:

Click to view products by [Panjit](#) manufacturer:

Other Similar products are found below :

[614233C](#) [648584F](#) [IRFD120](#) [JANTX2N5237](#) [2N7000](#) [FCA20N60_F109](#) [FDZ595PZ](#) [2SK2545\(Q,T\)](#) [405094E](#) [423220D](#)
[TPCC8103,L1Q\(CM](#) [MIC4420CM-TR](#) [VN1206L](#) [614234A](#) [715780A](#) [NTNS3166NZT5G](#) [SSM6J414TU,LF\(T](#) [751625C](#) [BUK954R8-60E](#)
[DMN3404LQ-7](#) [NTE6400](#) [SQJ402EP-T1-GE3](#) [2SK2614\(TE16L1,Q\)](#) [2N7002KW-FAI](#) [DMN1017UCP3-7](#) [EFC2J004NUZTDG](#) [ECH8691-](#)
[TL-W](#) [FCAB21350L1](#) [P85W28HP2F-7071](#) [DMN1053UCP4-7](#) [NTE221](#) [NTE2384](#) [NTE2903](#) [NTE2941](#) [NTE2945](#) [NTE2946](#) [NTE2960](#)
[NTE2967](#) [NTE2969](#) [NTE2976](#) [NTE455](#) [NTE6400A](#) [NTE2910](#) [NTE2916](#) [NTE2956](#) [NTE2911](#) [TK10A80W,S4X\(S](#) [SSM6P69NU,LF](#)
[DMP22D4UFO-7B](#) [DMN1006UCA6-7](#)