



RB521S30

SURFACE MOUNT SCHOTTKY DIODES

VOLTAGE 30 Volt **CURRENT** 200 mA

FEATURES

- Extremely High Switching Speed
- Surface mount package ideally suited for automatic insertion
- Lead free in compliance with EU RoHS 2011/65/EU directive
- Green molding compound as per IEC61249 Std. . (Halogen Free)

MECHANICAL DATA

- Case: SOD-523, Plastic
- Terminals: Solderable per MIL-STD-750, Method 2026
- Appox Weight: 0.00005 ounces, 0.0014 grams
- Marking: 21

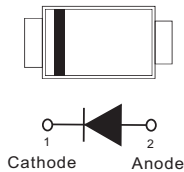

SOD-523 Unit : inch(mm)

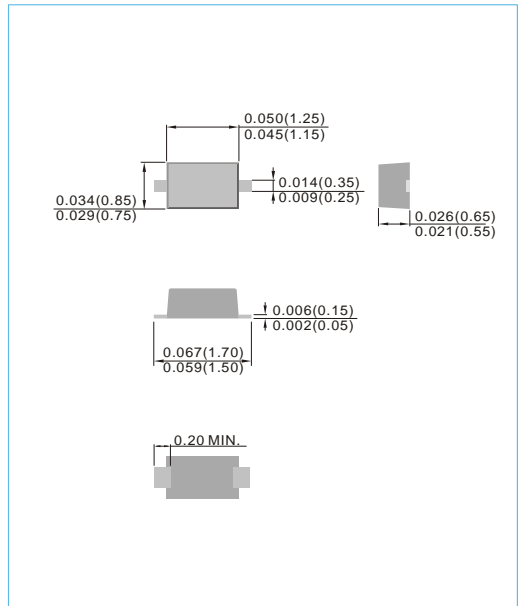

ABSOLUTE RATINGS

PARAMETER	Symbol	Value	Units
Peak Reverse Voltage	V_{RM}	30	V
Mean Rectifying Current	$I_{F(AV)}$	0.2	A
Peak Forward Surge Current@Tp=1s	I_{FSM}	1	A
Operating Junction and Storage Temperature Range	T_J, T_{STG}	-55 to + 125	°C

ELECTRICAL CHARACTERISTICS ($T_J = 25^\circ\text{C}$ unless otherwise noted)

PARAMETER	Symbol	MIN.	TYP.	MAX.	Units	Conditions
Forward Voltage	V_{F1}	-	-	0.50	V	$I_F = 200\text{mA}$
Forward Voltage	V_{F2}	-	-	0.35	V	$I_F = 10\text{mA}$
Reverse Current	I_{R1}	-	-	10	μA	$V_R = 10\text{V}$
Reverse Current	I_{R2}	-	-	100	μA	$V_R = 30\text{V}$



RB521S30

RATING AND CHARACTERISTIC CURVES

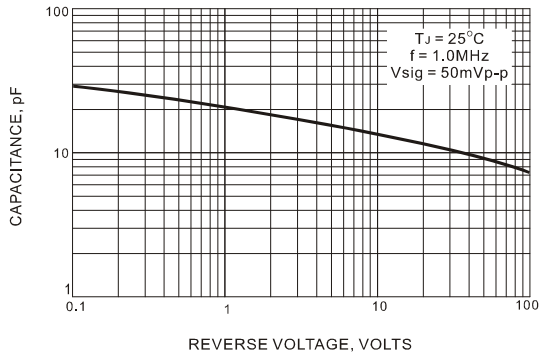

FIG.1 TYPICAL JUNCTION CAPACITANCE

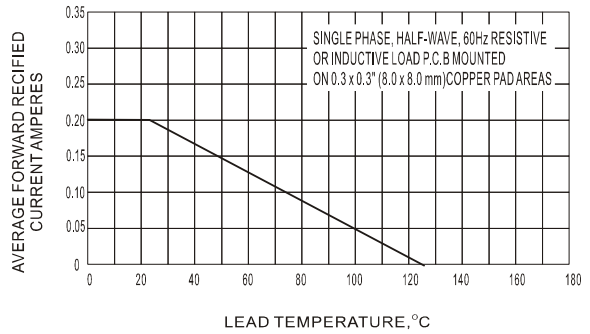

FIG.2 MAXIMUM AVERAGE FORWARD CURRENT DERATING

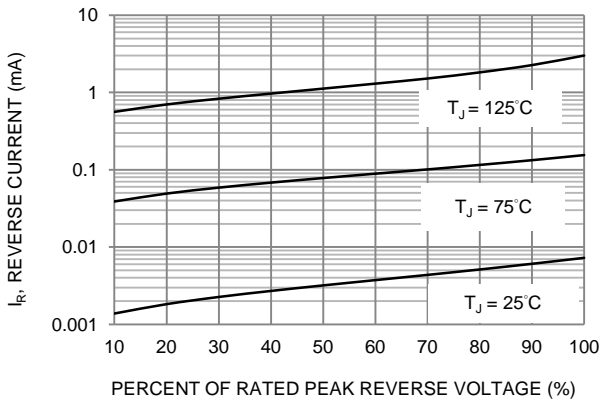

FIG.3 TYPICAL REVERSE CHARACTERISTICS

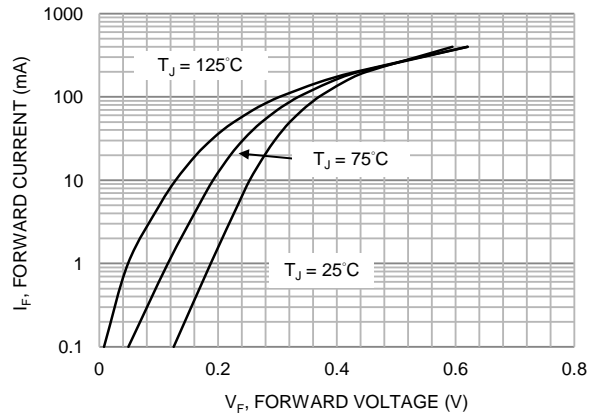

FIG.4 TYPICAL FORWARD CHARACTERISTICS

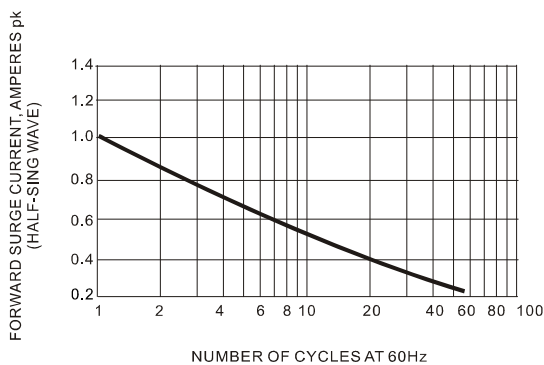

FIG.5 MAXIMUM NON-REPEITIVE SURGE CURRENT

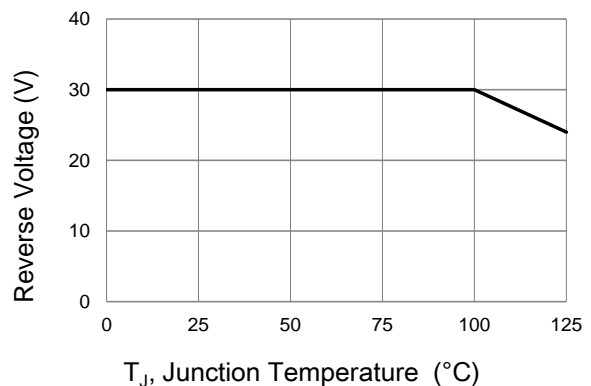
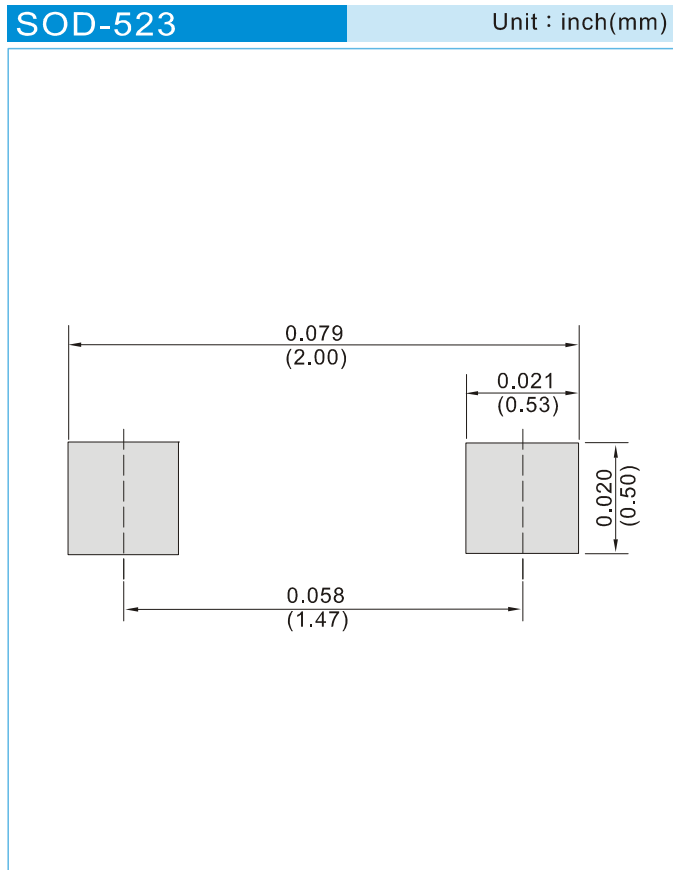

Fig.* Operating Temperature Derating Curve



RB521S30

MOUNTING PAD LAYOUT



ORDER INFORMATION

- Packing information
T/R - 12K per 13" plastic Reel
T/R - 5K per 7" plastic Reel



RB521S30

Part No_packing code_Version

RB521S30_R1_00001

RB521S30_R2_00001

For example :

RB500V-40_R2_00001



Packing Code XX				Version Code XXXXX		
Packing type	1 st Code	Packing size code	2 nd Code	HF or RoHS	1 st Code	2 nd ~5 th Code
Tape and Ammunition Box (T/B)	A	N/A	0	HF	0	serial number
Tape and Reel (T/R)	R	7"	1	RoHS	1	serial number
Bulk Packing (B/P)	B	13"	2			
Tube Packing (T/P)	T	26mm	X			
Tape and Reel (Right Oriented) (TRR)	S	52mm	Y			
Tape and Reel (Left Oriented) (TRL)	L	PANASERT T/B CATHODE UP (PBCU)	U			
FORMING	F	PANASERT T/B CATHODE DOWN (PBCD)	D			



RB521S30

Disclaimer

- Reproducing and modifying information of the document is prohibited without permission from Panjit International Inc..
- Panjit International Inc. reserves the rights to make changes of the content herein the document anytime without notification. Please refer to our website for the latest document.
- Panjit International Inc. disclaims any and all liability arising out of the application or use of any product including damages incidentally and consequentially occurred.
- Panjit International Inc. does not assume any and all implied warranties, including warranties of fitness for particular purpose, non-infringement and merchantability.
- Applications shown on the herein document are examples of standard use and operation. Customers are responsible in comprehending the suitable use in particular applications. Panjit International Inc. makes no representation or warranty that such applications will be suitable for the specified use without further testing or modification.
- The products shown herein are not designed and authorized for equipments requiring high level of reliability or relating to human life and for any applications concerning life-saving or life-sustaining, such as medical instruments, transportation equipment, aerospace machinery et cetera. Customers using or selling these products for use in such applications do so at their own risk and agree to fully indemnify Panjit International Inc. for any damages resulting from such improper use or sale.
- Since Panjit uses lot number as the tracking base, please provide the lot number for tracking when complaining.

X-ON Electronics

Largest Supplier of Electrical and Electronic Components

Click to view similar products for [Schottky Diodes & Rectifiers](#) category:

Click to view products by [Panjit](#) manufacturer:

Other Similar products are found below :

[MA4E2039](#) [D1FH3-5063](#) [MBR0530L-TP](#) [MBR10100CT-BP](#) [MBR1545CT](#) [MMBD301M3T5G](#) [RB160M-50TR](#) [RB551V-30](#)
[BAS16E6433HTMA1](#) [BAT 54-02LRH E6327](#) [NSR05F40QNXT5G](#) [JANS1N6640](#) [SB07-03C-TB-H](#) [SB1003M3-TL-W](#) [SK310-T](#) [SK32A-](#)
[LTP](#) [SK34B-TP](#) [SS3003CH-TL-E](#) [GA01SHT18](#) [CRS10I30A\(TE85L,QM](#) [MA4E2501L-1290](#) [MBRB30H30CT-1G](#) [SB007-03C-TB-E](#)
[SK32A-TP](#) [SK33B-TP](#) [SK38B-TP](#) [NRVBM120LT1G](#) [NTE505](#) [NTSB30U100CT-1G](#) [SS15E-TP](#) [ACDBA1100LR-HF](#) [ACDBA1200-HF](#)
[ACDBA140-HF](#) [ACDBA2100-HF](#) [ACDBA3100-HF](#) [CDBQC0530L-HF](#) [CDBQC0240LR-HF](#) [ACDBA260LR-HF](#) [ACDBA1100-HF](#)
[SK310B-TP](#) [MA4E2502L-1246](#) [MA4E2502H-1246](#) [NRVBM120ET1G](#) [NSR01L30MXT5G](#) [SB560](#) [PMAD1108-LF](#) [SD103ATW-TP](#)
[1N5819T-G](#) [PDS1040Q-13](#) [MBR3060FCTe3/TU](#)